

Technical Support Guide

Subaru SD Card Navigation System

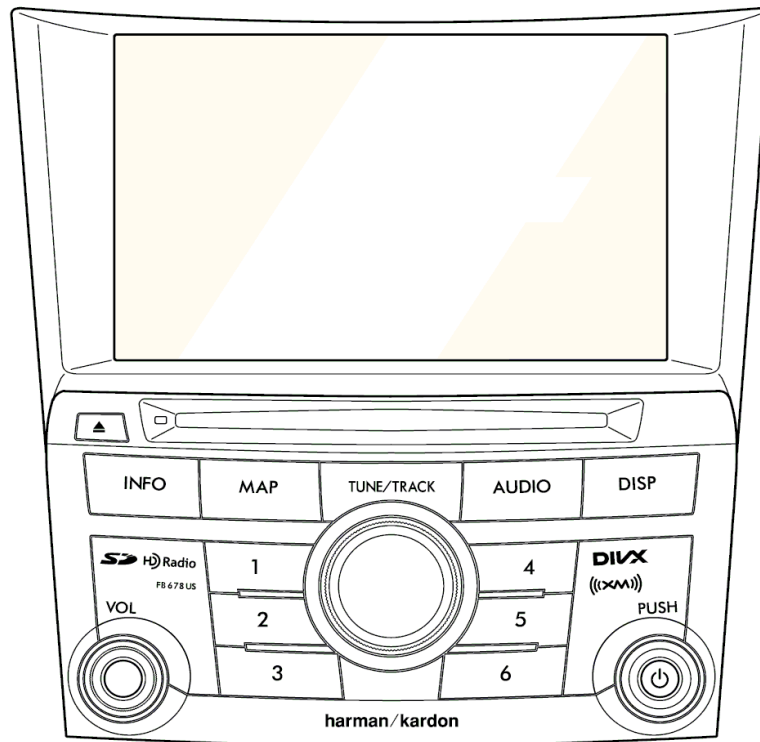

2013-14 Legacy / Outback

Technical Support Guide

**Subaru SD Card Navigation System
2013-14 Legacy / Outback**

Contents

1. Introduction of Subaru SD Card Navigation System

- Outline of Subaru SD Card Navigation System	4-5
- Hardware	6
- Screen Layout	7
- Software	8
- Audio Function	9-10
- Navigation Function	11
- Other Function	12-13

2. Troubleshooting

- System Diagram	14
- Terminal of Navigation system	15-17
- Specification of Line Diagram	18-21
- No power	22
- No sound (All modes)	23
- No sound (AM/FM).....	24
- No sound (Satellite radio)	25
- No sound (CD)	26
- No sound (USB)	27
- No sound (iPod)	28
- CD skip	29
- CD won't play correctly	30
- Sound is discomforting	31
- No illumination	32
- No display	33
- Current GPS position does not move	34
- Bluetooth does not work	35
- Rear View Camera won't display	36
- Aha Radio	37-56

3. Frequently Asked Questions (FAQ)

- Navigation	58-71
- Bluetooth Hands-free	72-89
- Audio / Visual	90-115
- Others	116-121

4. Glossary

- [A] - [M]	122
- [N] - [S]	123
- [U] - [number]	124

1. Introduction of Subaru SD Card Navigation System

Outline of Subaru SD Card Navigation System

Applicable Models

Vehicle	Country	ID	SUBARU No.	SD Part No.	Map Ver.
13MY Legacy / Outback w/ H/K Amp	USA	FB678US	86271AJ67A	86283AJ67A	2011 Q3
	CANADA	FB778US	86271AJ77A		
13MY Legacy / Outback w/ Aha Radio, w/ H/K Amp	USA	FE688US	86271AJ68A	86283AJ68A	
	CANADA	FE788US	86271AJ78A		
14MY Legacy / Outback w/ Aha Radio, w/ H/K Amp	USA	FE688US	86271AJ80A	86283AJ66A	2012 Q3
	CANADA	FE788US	86271AJ90A		
14MY Legacy / Outback w/ Aha Radio	USA	FE699US	86271AJ81A	86283AJ69A	

Head Unit and SD Card Combination

Please verify that the correct SD card is inserted in every head unit.

SD card must be returned with any exchange unit core.

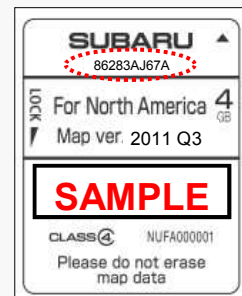

Product Overview

Basic function	Navi media	Display	Voice recognition	
	SD (4GB)	7-inch WVGA	Yes	
Navi	Junction view	Voice recognition	Traffic information	Motorway information
	Yes	Yes	XM	Yes
Audio	Satellite radio	HD radio	USB audio / video	iPod control
	XM	*Yes	Yes	Yes
Other	Steering SW	Rear view camera	Bluetooth	Read out SMS / Email
	Yes	Yes (if applicable)	Yes	Yes

*HD Radio service available in USA only (as of May 2013)

Summary of Features

		13-14MY Legacy / Outback
AV	Display	7-inch WVGA
	Deck	Single CD
	Satellite radio	XM
	iPod/iPhone control	Yes
	USB Audio/Video	Yes
	HD Radio	Yes *1
	Aha Radio	Yes *2
	SD Picture	Yes
	SMS/Email read out	Yes
	Voice recognition	Yes (English, Spanish, French)
Navi	Motorway service information	Yes
	Green route search	Yes
	3D Junction display	Yes
	Traffic information	Yes (XM-Traffic)
	Voice recognition (VR)	Yes (English, Spanish, French)
	Map Web download	Yes
Other	Rear view camera	Yes (if applicable)

*1 HD Radio service available in USA only (as of May 2013)

*2 Aha Radio is not available for 86271AJ67A and 86271AJ77A

1. Introduction of Subaru SD Card Navigation System

Hardware

INFO button

Press to display the information screen.

TUNE/TRACK knob

Rotate to select a radio station, track, or file.

MAP button

Press to display the navigation screen.

AUDIO button

Press to display the audio

EJECT button

Press to eject the DISC.

DISP button

Press to display the picture quality adjustment screen.

CD slot

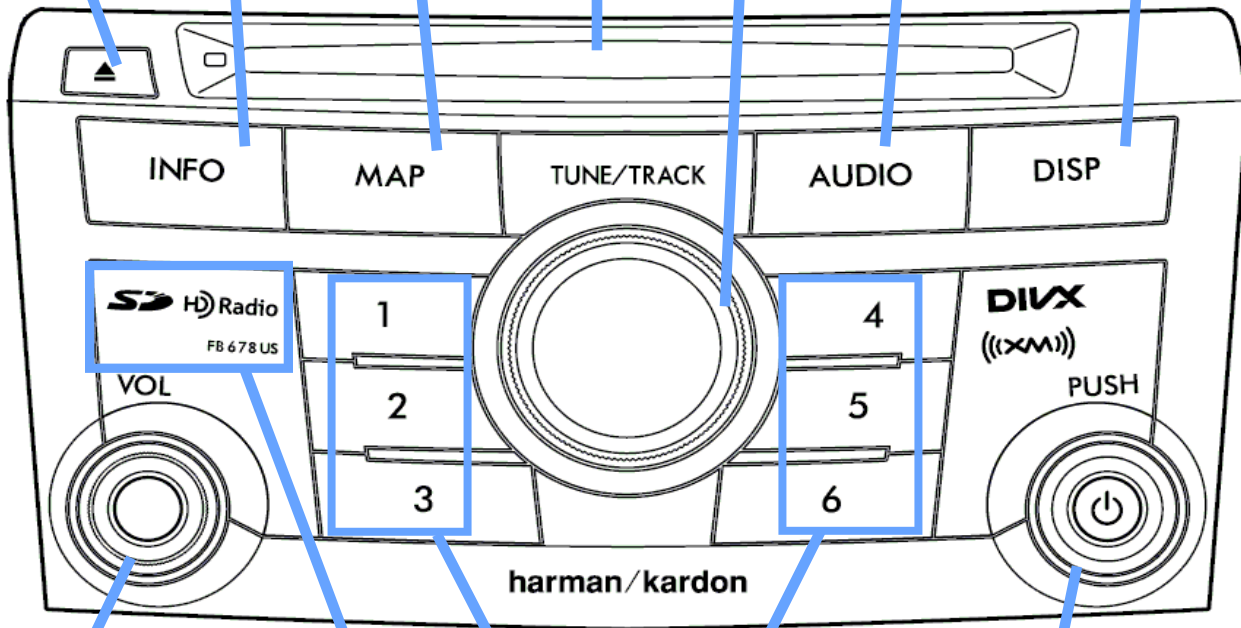

VOL knob

Rotate: Adjust the volume

POWER button

Press: Audio Power ON or OFF

SD memory card slot

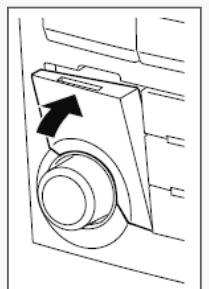
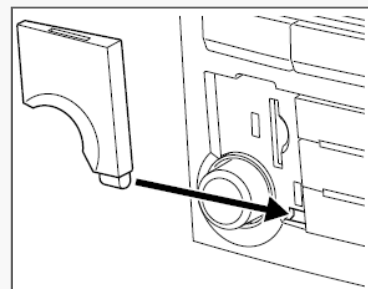
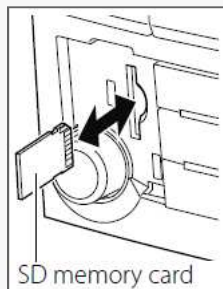
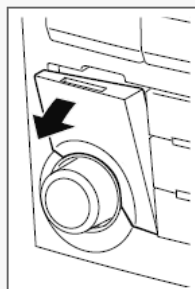

Screen Layout



Audio Source Selector

Basic Control of Audio Function

Control of Navigation Function

<Navigation Mode>

Split Screen



Changing the screens can be done by touching the icon on the screen.

Full Map Screen



<Audio Mode>

Full Audio Screen



[AUDIO]

[MAP]

1. Introduction of Subaru SD Card Navigation System Software



The main functions of the system include:

- (1) Audio
- (2) Navigation
- (3) Information

(1) Audio function



Audio Source Selector

In addition to radio and CDs, the system can also play back sources such as iPods, iPhones, USB and Bluetooth Audio devices. (Aha Radio if equipped)

Sound quality can also be adjusted using the operation screen.

(2) Navigation function



Navigation Menu Button

Apart from the easy-to-view screen guides, other features offered include detailed location information displays, a variety of adjustable guide maps, and simple route change functions

(3) Information function

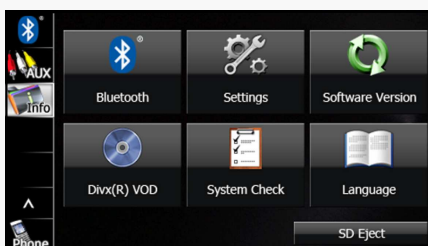

In addition to display settings, other settings such as and wallpapers are also available.

Audio Function

HD radio, XM, Aha

Integrated HD Radio, XM and Aha

HD Radio, XM Tuner Control



HD Radio service available in USA only (as of May 2013)

XM Traffic Information

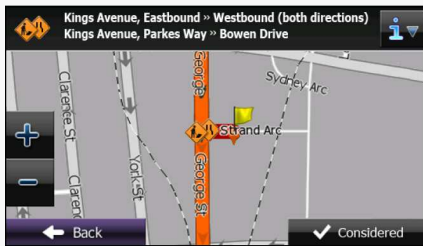

XM is paid service and subscription is required

Aha Radio

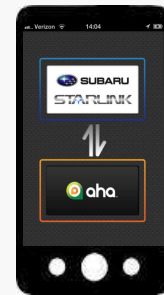

Smartphone with Data service is required for Aha functions.

Aha Radio is not available for 86271AJ67A and 86271AJ77A.

Voice Recognition

Operate Navigation and Audio by voice commands

Microphone

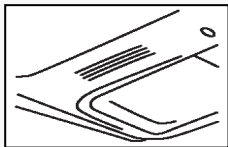

Voice recognition button

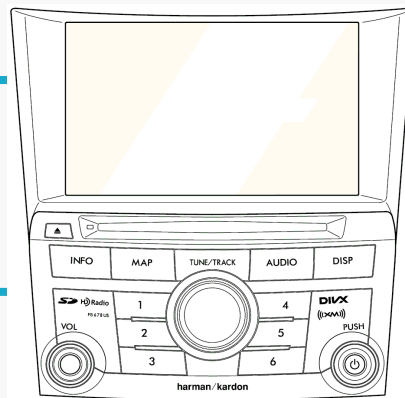

Talk back from vehicle speaker
“Voice command please”

Voice Control function	Change audio source	Audio control	Destination search	Hands-free dial	iPod select songs	USB select folder
	Yes	Yes	Yes	Yes	Yes	Yes

1. Introduction of Subaru SD Card Navigation System

Audio Function

Movie



<USB flash memory>

Max data size: 8GB

Class: USB mass storage class



*Compressed video file is supported for USB only.

<Read and play condition>

Max picture resolution size: 720*576 pixel

Max layers of directory: 8 layers

Max number of folders (overall): 3000

Max number of files (overall): 9999

<Video format>

DivX	WMV	MP4
Yes	Yes	Yes

<Reference> Audio Format

MP3	WMA
Yes	Yes

*Playback is dependent on the specific version of the file format.

SD Picture



<SD card>

Max data size: 64GB

SD card class: ALL

*Slide show supports SD card only.

*Slide show cannot be displayed while Navi Mode is active

*Some SD Cards functions above may not be supported based on SD Card manufacturer specifications.

<Features>

4 slideshow effects

Automatic resizing

Setting as Opening screen

<Read and play condition>

Format: JPEG

Max picture data size: 10MB

Max layers of directory: 8 layers

Max number of files (overall): 500

<Limitation while driving>

The picture slide show will stop once start driving and the last picture will be displayed on the screen.

Caution:

Do not add photo data on Map SD Card. It may damage the software file. Always use a different SD card to store photo data.

Navigation Function

3D Junction Display



When approaching an expressway exit or a complicated intersection, the map switches to a 3D display.

Voice Recognition

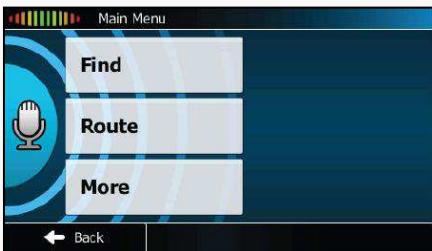

By using the voice control system, the destination can be set by speaking voice commands. This enables you to use functions that are usually inaccessible while driving.

Motorway



Highway service area information is useful for a long drive.

Green Route



The Green route function enables the search for routes that reduce fuel consumption and CO2 emissions.

Altitude Reading



The function shows the altitude of the road currently being driven and measured by the GPS receiver. The minimum of 4 acquired satellites is required to establish Altitude. With 3 or less acquired satellites, "- -" may be displayed on the navigation screen.

1. Introduction of Subaru SD Card Navigation System

Other Function

Rear View Camera (Option)

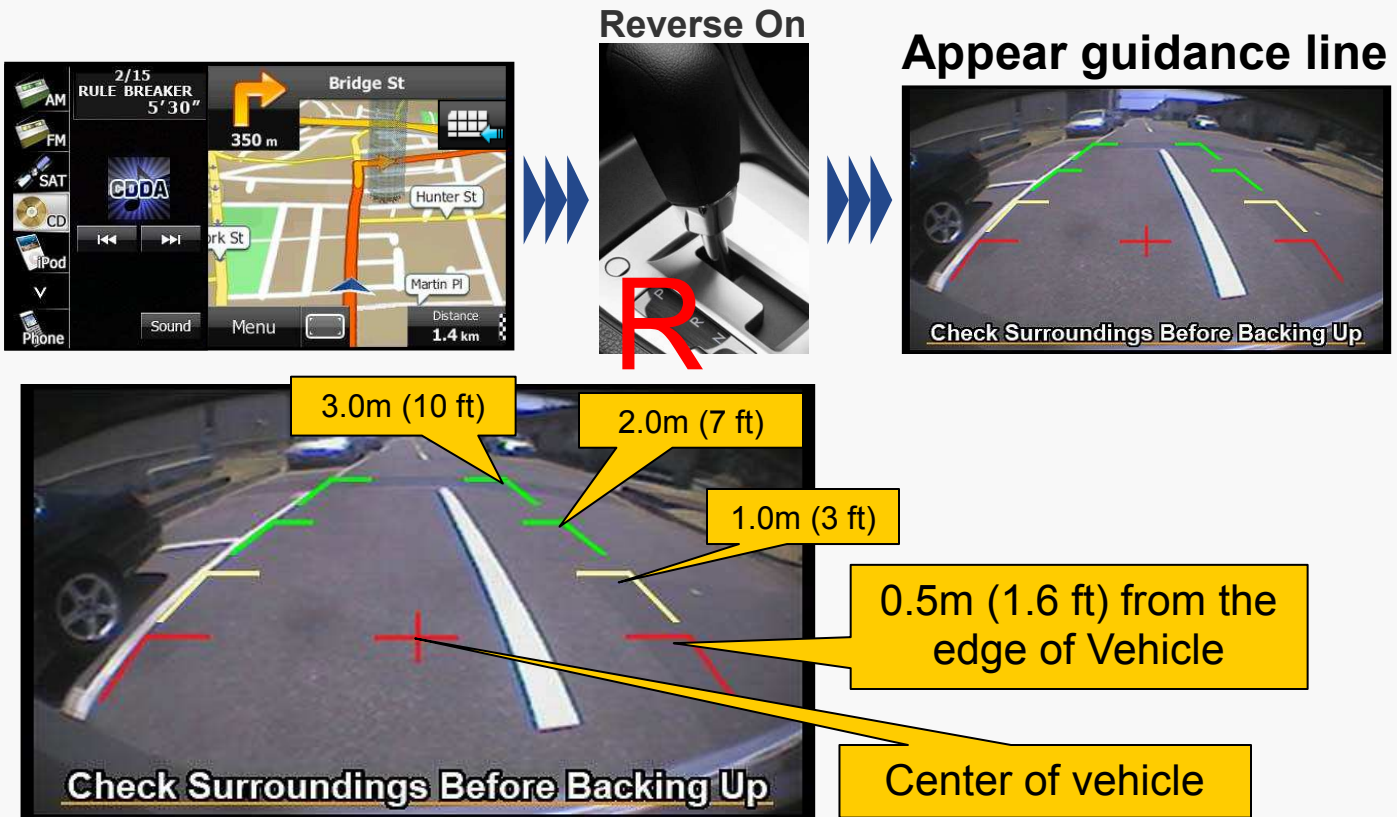

Read out SMS/Email

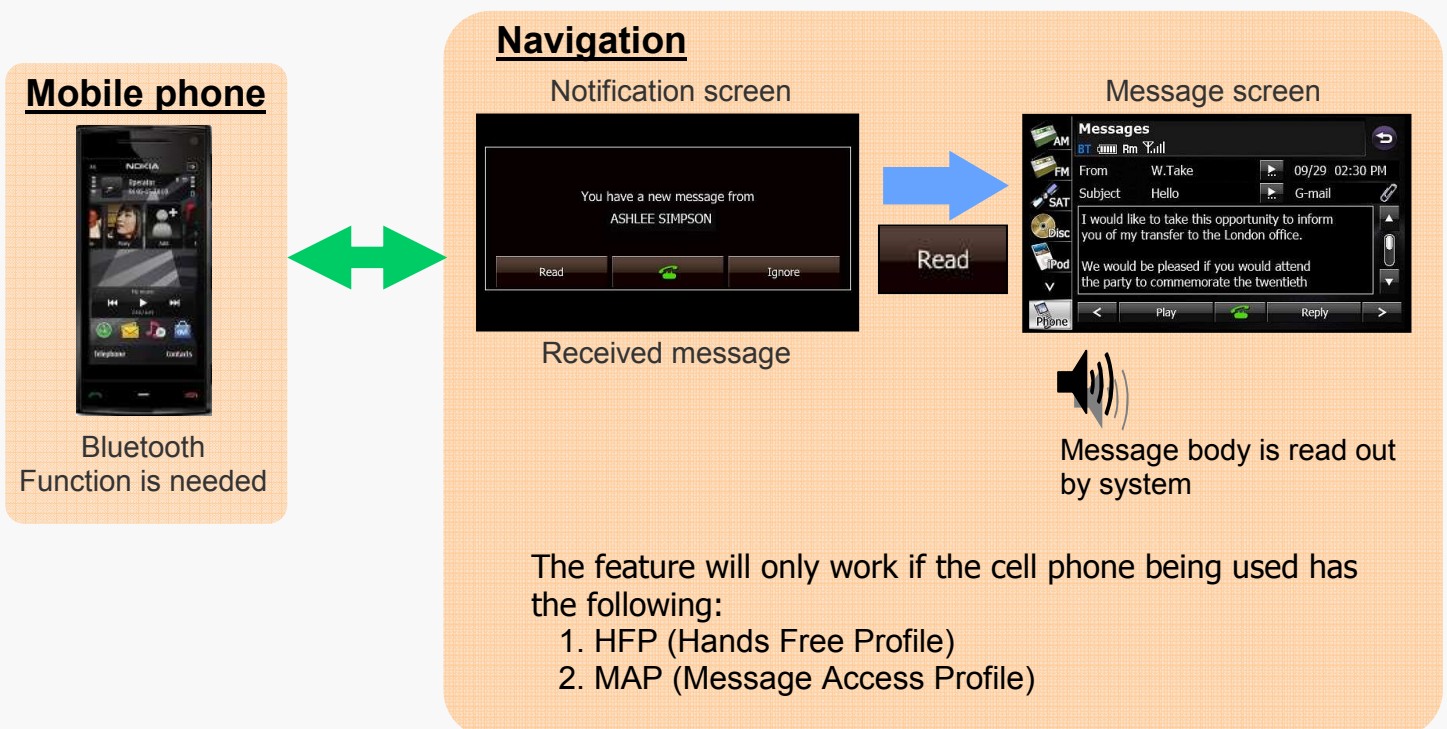

Map Update

NAVTEQ Map Update Service

NAVTEQ, acquired by Nokia provides Map Update Service for SD Card Navigation System. Please visit the website and make sure which map version is currently available.

<https://subaru-us.naviextras.com/>

The screenshot shows the NAVTEQ website interface for Subaru. At the top left is the Subaru logo with the tagline "Confidence in Motion". On the right, there is a user account section with a profile icon, the text "Welcome Guest user! Log in or register", and a language dropdown menu set to "English". The main banner features an aerial view of a complex highway interchange with a semi-transparent text box that reads "DOWNLOADABLE MAP UPDATES FOR 2012-2013 MY SUBARU VEHICLES AVAILABLE NOW". In the bottom right corner of the banner, there is a "Current region North America" button with a refresh icon. Below the banner are four main navigation buttons: "GET FREE UPDATES", "BUY UPDATES OR EXTRAS", "REDEEM YOUR CODE OR ACTIVATE", and "HAVE QUESTIONS OR NEED HELP?". Each button has a right-pointing arrow. Underneath these buttons are four corresponding text boxes providing detailed instructions and links for each category. The "HAVE QUESTIONS OR NEED HELP?" box lists support topic highlights: "> 'HOW TO UPDATE?' GUIDE", "> IS MY DEVICE TYPE SUPPORTED?", "> DOWNLOAD PC TOOL", and "> TECHNICAL SUPPORT".

Map Update Support:

If you can't find the answer to your question or for advice on the map inside Navigation System, please contact NAVTEQ via website or call NAVTEQ at 1-888-628-6277 Monday through Friday, 9am - 8pm Eastern Time. NAVTEQ will respond to your inquiry within 72 hours.

2. Troubleshooting

System Diagram

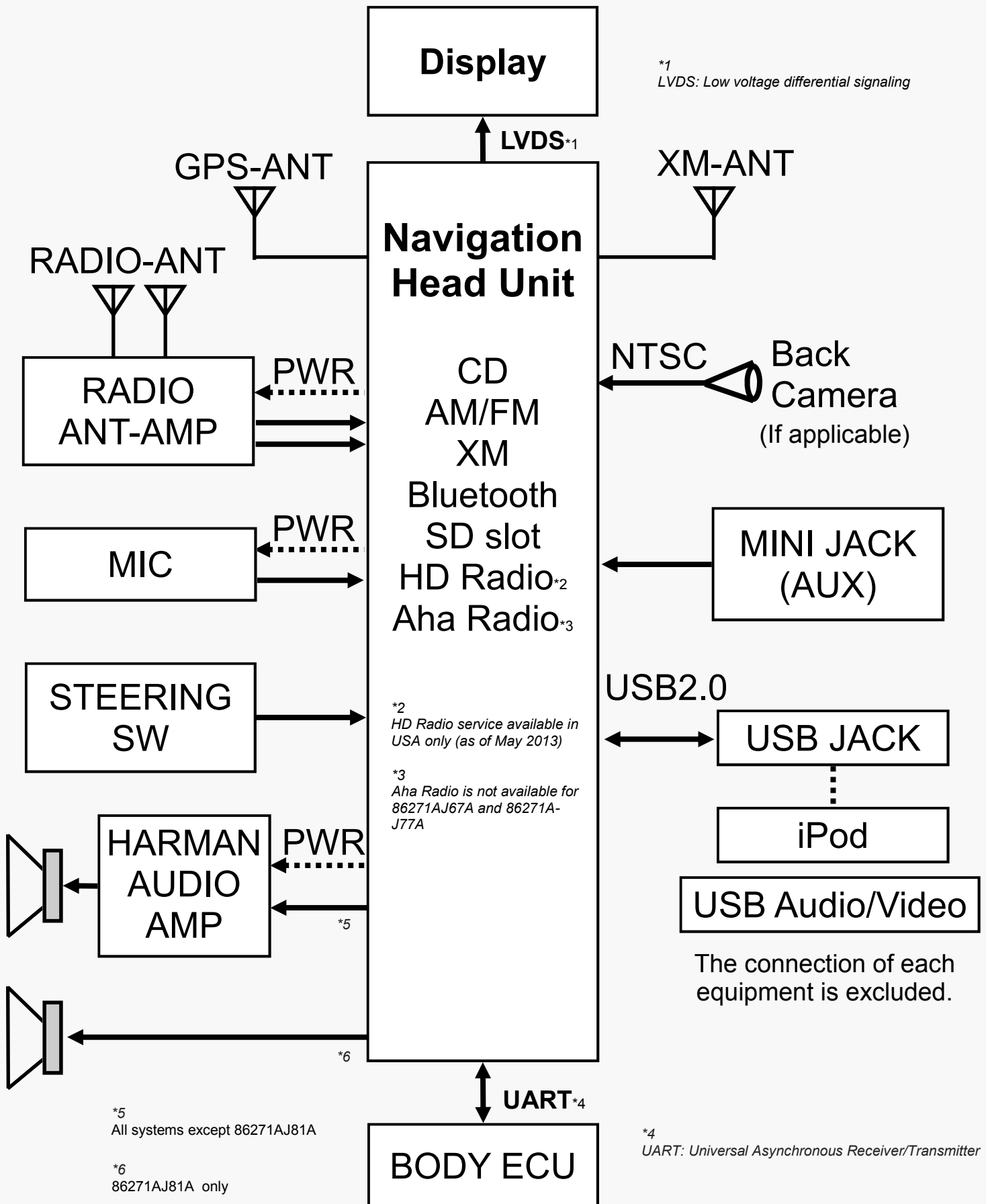

Connections and Pins

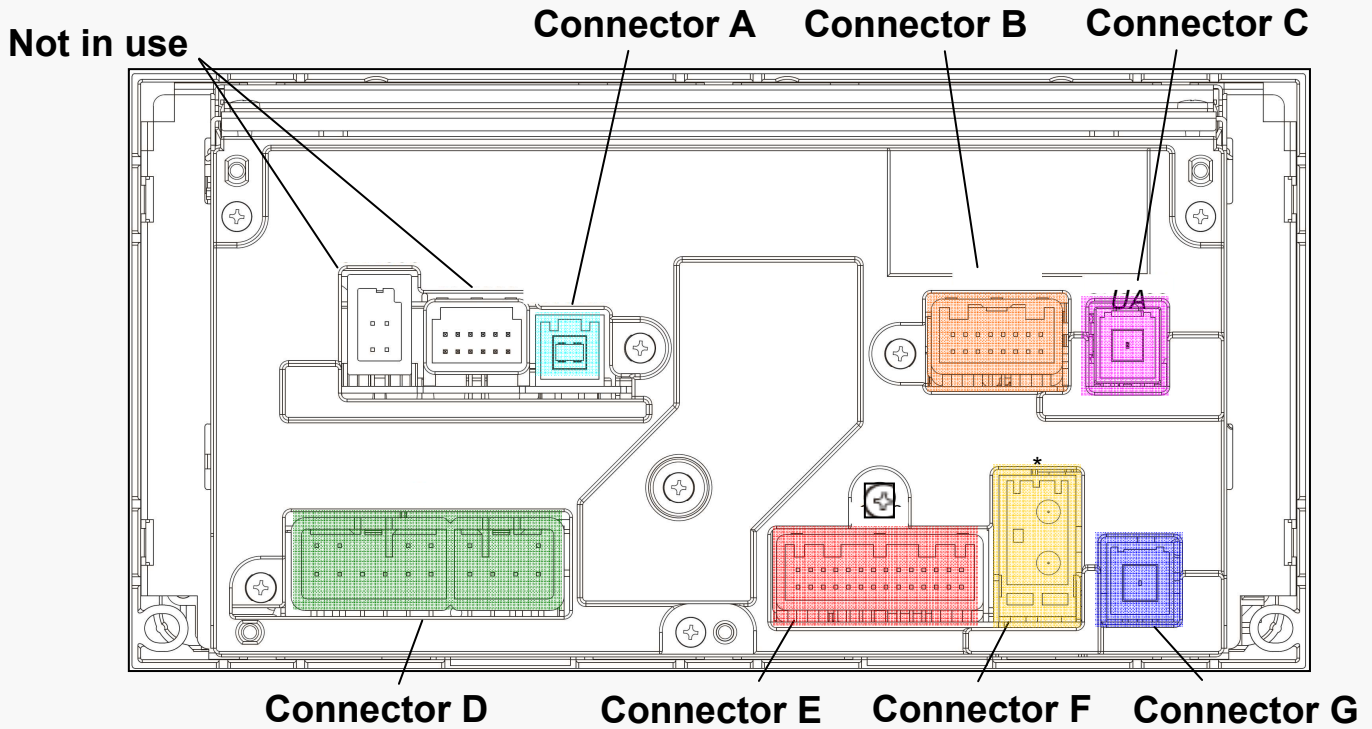

Connector A (USB)	Pin	Signal	Function
	1	USV1	OUT USB audio power supply (5V)
	2	US1-	IN/OUT USB audio data
	3	US1+	IN/OUT USB audio data
	4	UGD1	GND Ground
	5	USG1	GND Ground

Connector B (REAR CAMERA) *if applicable	Pin	Signal	Function
	1		
	2	N.C.	- No connection
	3		
	4	UART	IN/OUT UART to/from Body ECU
	5	N.C.	- No connection
	6	PKB	IN Parking brake signal (12V)
	7	CA+	OUT Back-eye camera power supply (6V)
	8	V+	IN Back-eye camera signal (NTSC)
	9		
	10		
	11	N.C.	- No connection
	12		
	13		
	14		
	15	CGND	GND Ground
	16	V-	GND Ground

Connector C (GPS ANTENNA)	Pin	Signal	Function
	1	ANT	IN GPS signal
	2	GND	GND Ground
	3	GND	GND Ground

2. Troubleshooting

Connections and Pins

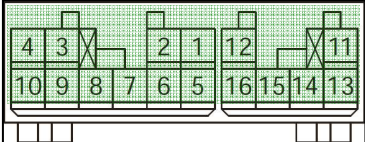
Connector D (POWER INPUT/ SIGNAL OUTPUT) 	1	FR+	OUT	Audio signal (Front Right)
	2	FL+	OUT	Audio signal (Front Left)
	3	ACC	IN	ACC power supply
	4	BU+B	IN	Back-up power supply
	5	FR-	OUT	Audio signal (Front Right)
	6	FL-	OUT	Audio signal (Front Left)
	7	GND	GND	Ground
	8	ANT+	OUT	Antenna amplifier power supply (12V)
	9	AMP+	OUT	Audio amplifier power supply (12V)
	10	ILL+	IN	Illumination signal (12V)
	11	RR+	OUT	Audio signal (Rear Right)
	12	RL+	OUT	Audio signal (Rear Left)
	13	RR-	OUT	Audio signal (Rear Right)
	14	SLD2	GND	Ground
	15	ILL-	IN	Illumination signal
	16	RL-	OUT	Audio signal (Rear Left)

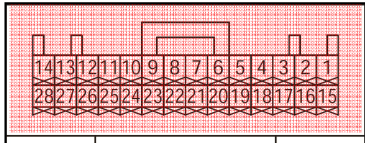
Connector E (ST-SW, MIC etc) 	1	N.C.	-	No connection	
	2	REV	IN	Reverse signal (12V)	
	3	BRIGHT	IN	No connection	
	4	MACC	OUT	Mic power supply (5V)	
	5	MIN+	IN	Mic signal	
	6	SNS2	IN	Mic detection	
	7				
	8				
	9	N.C.	-	No connection	
	10				
	11	AGND	GND	Ground	
	12				
	13				
	14	N.C.	-	No connection	
	15				
	16				
	17	SPD	IN	Vehicle speed signal	
	18	SGND	GND	Ground	
	19	MIN-	IN	Mic signal	
	20	N.C.	-	No connection	
	21	SW1	IN	Mic sw signal	
	22	SW2	IN	Mic sw signal	
	23	SWG	GND	Ground	
	24	N.C.	-	No connection	
	25				
	26				
	27	N.C.	-	No connection	
	28				

Connections and Pins

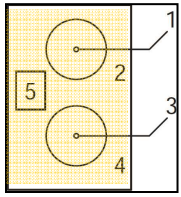
Connector F (RADIO ANTENNA) 	1	SUB-ANT-IN	IN	Radio signal (Sub)
	2	SUB-ANT-GND	IN	Ground
	3	MAIN-ANT-IN	IN	Radio signal (Main)
	4	MAIN-ANT-GND	GND	Ground
	5	N.C.	-	No connection

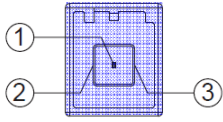
Connector G (XM ANTENNA) 	1	XM SIG	IN	XM signal
		XM ANT +B	OUT	XM Antenna +B (5V)
	2	GND	GND	Ground
	3	GND	GND	Ground

2. Troubleshooting

Specification of Line Diagram

1. Outline

Line Diagram can check the connectivity of devices, the vehicle signals, the radio reception and rear view camera setting.

2. How to enter Line Diagnostic mode

2-1. Enter the Diagnostic mode

Procedure:

1. Turn off audio by pressing "PWR" button.
2. While pressing both buttons (a) and (b), press and hold the button (c) for more than 3 seconds.

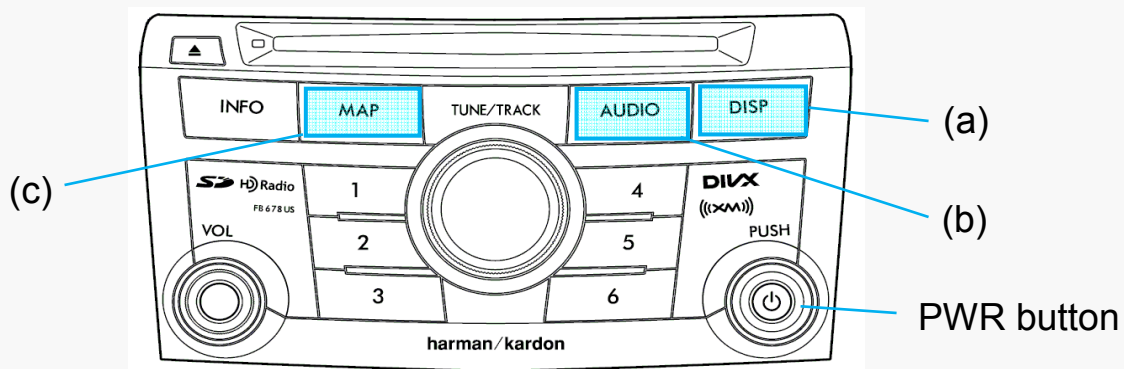

2-2. Exit the diagnostic mode

Press and hold the button (b) for more than 3 seconds, or turning the ignition switch from ACC OFF to ON position.

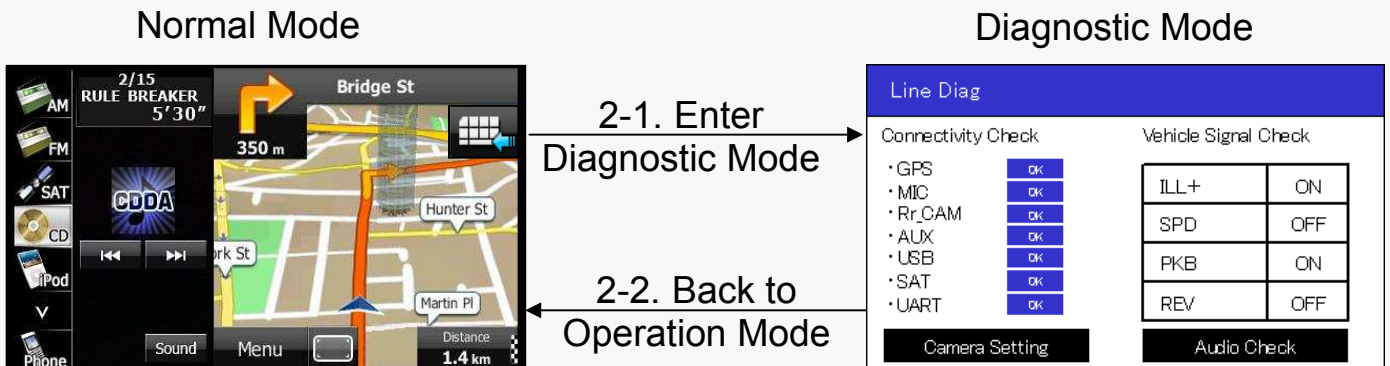

3. Display Layout and Explanation

3-1. Top Display Layout

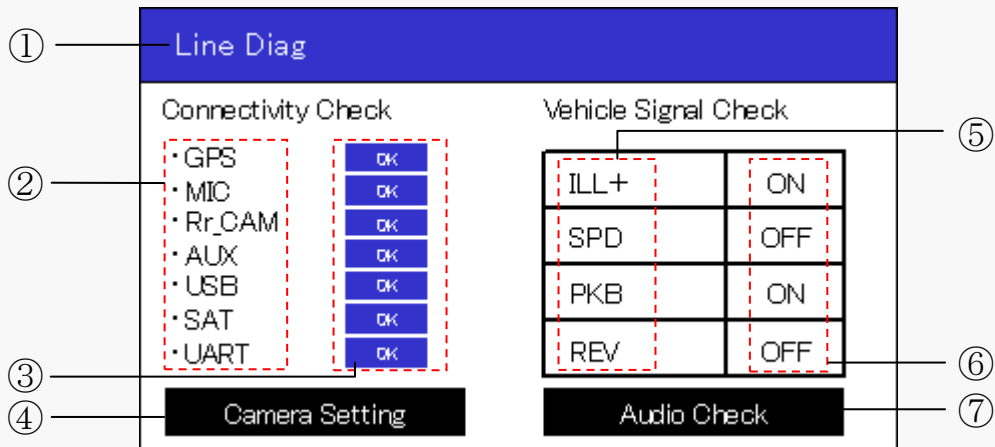

No	Explanation
①	Main title [White] after check [Black] under check
②	Connected Devices
③	Results of Connectivity Check

No	Explanation
④	Enter Camera Setting
⑤	Vehicle Signal
⑥	Vehicle Signal Check Results
⑦	Enter Audio Check

3-2. Enter "Camera Setting"

If "Camera Setting" button is touched, the screen changes to "Camera Setting" mode.

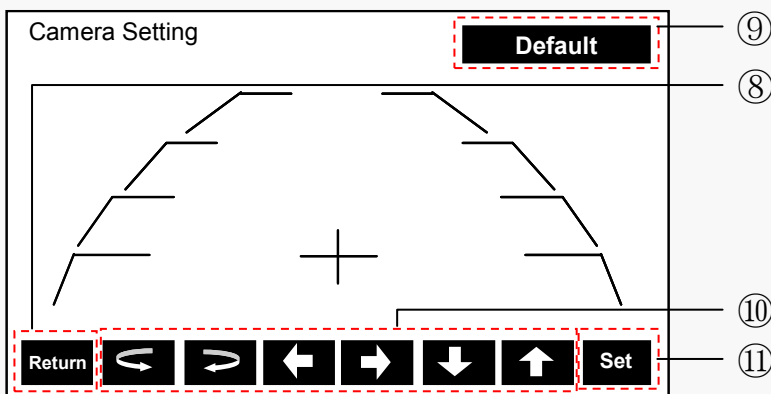

No	Explanation
⑧	Return to Previous Screen
⑨	Initialization of Marker Line Adjustment
⑩	Marker Line Adjustment
⑪	Finalization of Marker Line Adjustment

Note:

For a detailed procedure to adjust the camera settings, refer to STIS. Please select the Service Manual and refer to the Navigation System under the Entertainment Section (ET)

2. Troubleshooting

Specification of Line Diagram

3-3. Enter "Audio Check"

If the "Audio Check" button is touched, the screen changes to "Audio Check" mode.

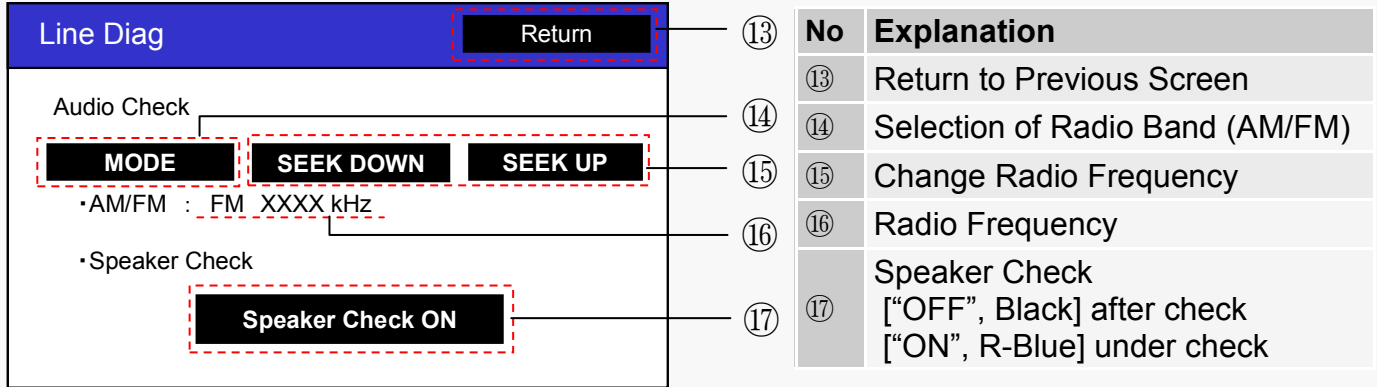

MEMO

2. Troubleshooting

NO POWER

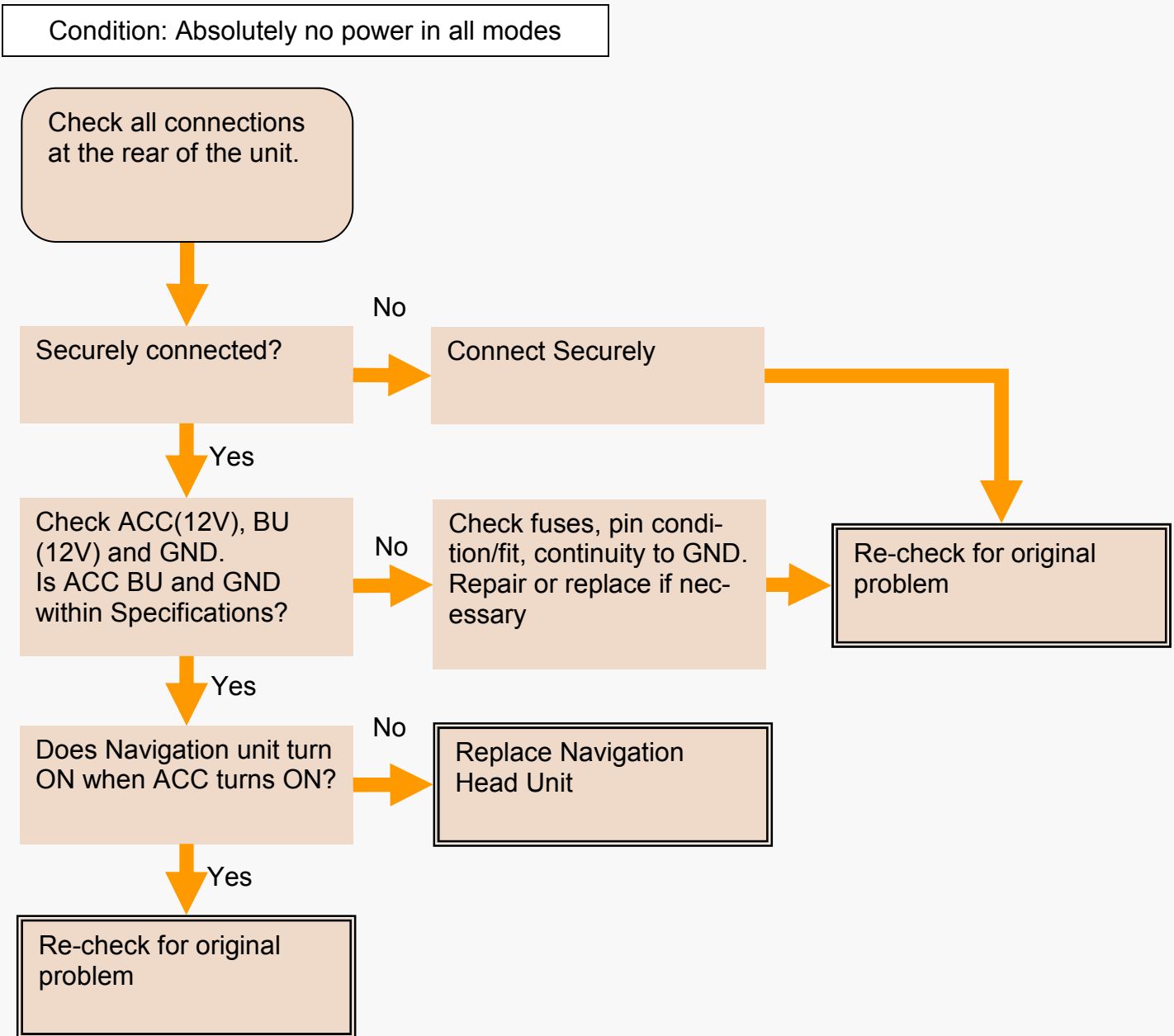

NO SOUND (All modes)

Condition: Absolutely no sound on all modes

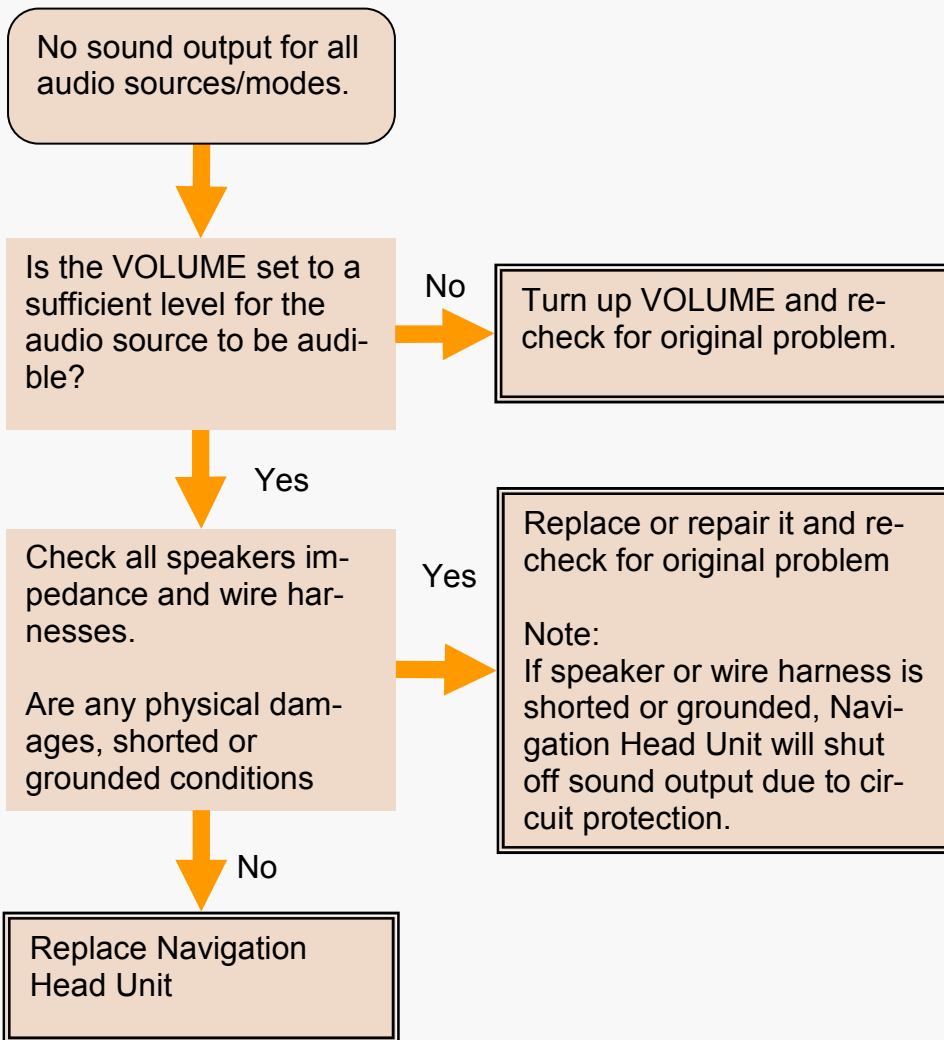

2. Troubleshooting

NO SOUND (AM/FM)

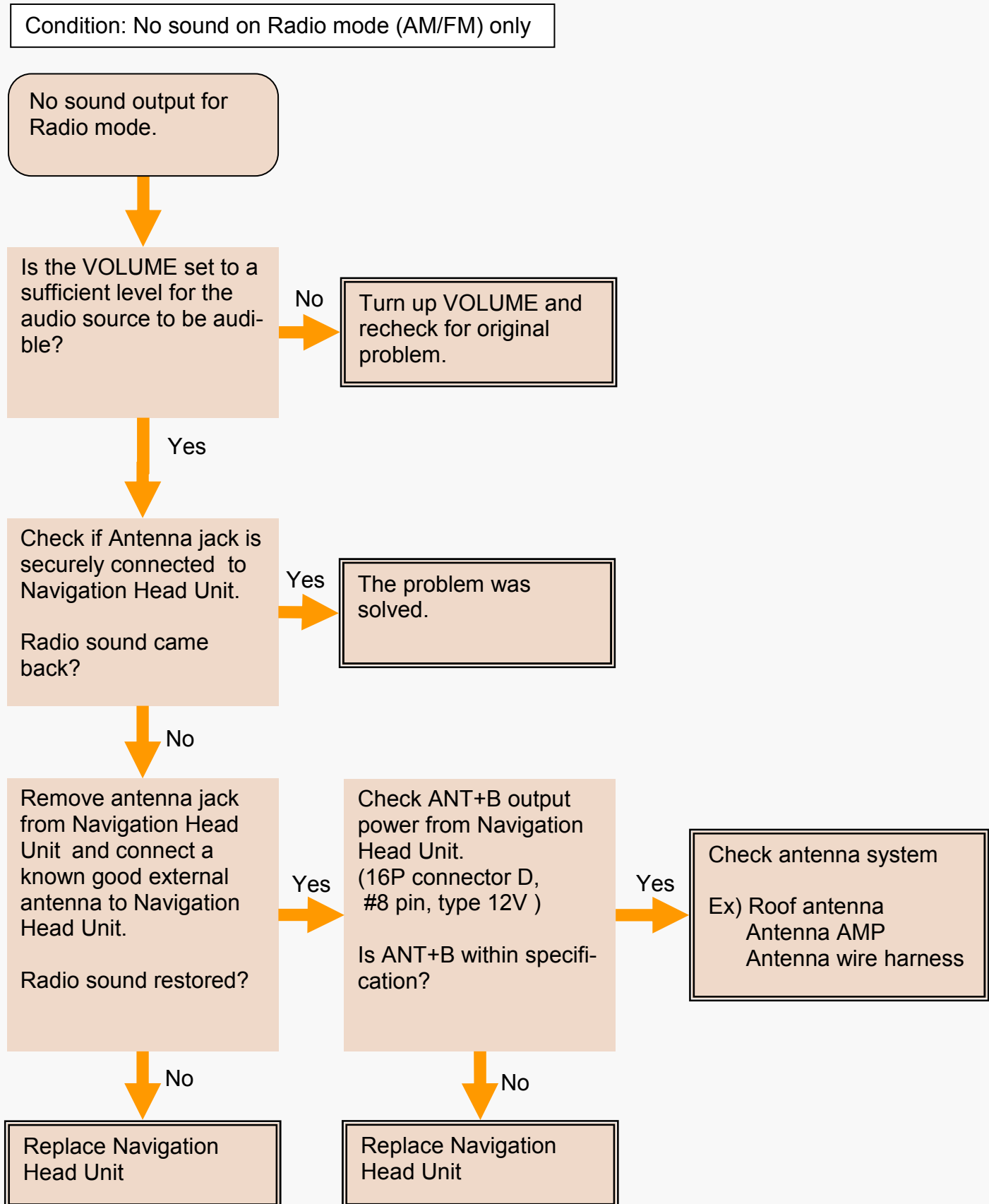

NO SOUND (SAT RADIO)

Condition: No sound on SAT radio mode only

No sound output for SAT (Satellite) radio

Check surroundings:
Is the vehicle in an environment where reception is difficult due to something blocking the area above the vehicle?

Yes

Move the vehicle and check it again.

No

Change to other modes (AM/FM/CD) and then select a XM mode again. Did the SAT radio sound come back?

Yes

The problem was solved.

No

SAT radio is a paid service. Did the customer's subscription expire? Or, did the free subscription provided by a dealer expire?

Yes

Contact Satellite Radio company and renew the subscription.

No

Check if Antenna jack is securely connected to Navigation Head Unit.
And check the connectivity in diagnostic mode.

Line Diag	
Connectivity Check	
· GPS	OK
· MIC	OK
· Rr.CAM	OK
· AUX	OK
· USB	OK
· SAT	OK
· UART	OK
Camera Setting	
Vehicle Signal Check	
ILL+	ON
SPD	OFF
PKB	ON
REV	OFF
Audio Check	

Yes

The problem was solved.

Is the SAT radio sound restored?

No

Remove antenna jack from Navigation Head Unit and connect a known good external antenna to Navigation Head Unit. Is the SAT radio sound restored?

Yes

Check antenna system (Antenna wire harness, Roof antenna, etc.)

Check XM output power from Navigation Head Unit. (1P connector G, type 5V)

Is XM within specification?

Yes

Replace Navigation Head Unit.

No

No

2. Troubleshooting

NO SOUND (CD)

Condition: No sound on CD mode only

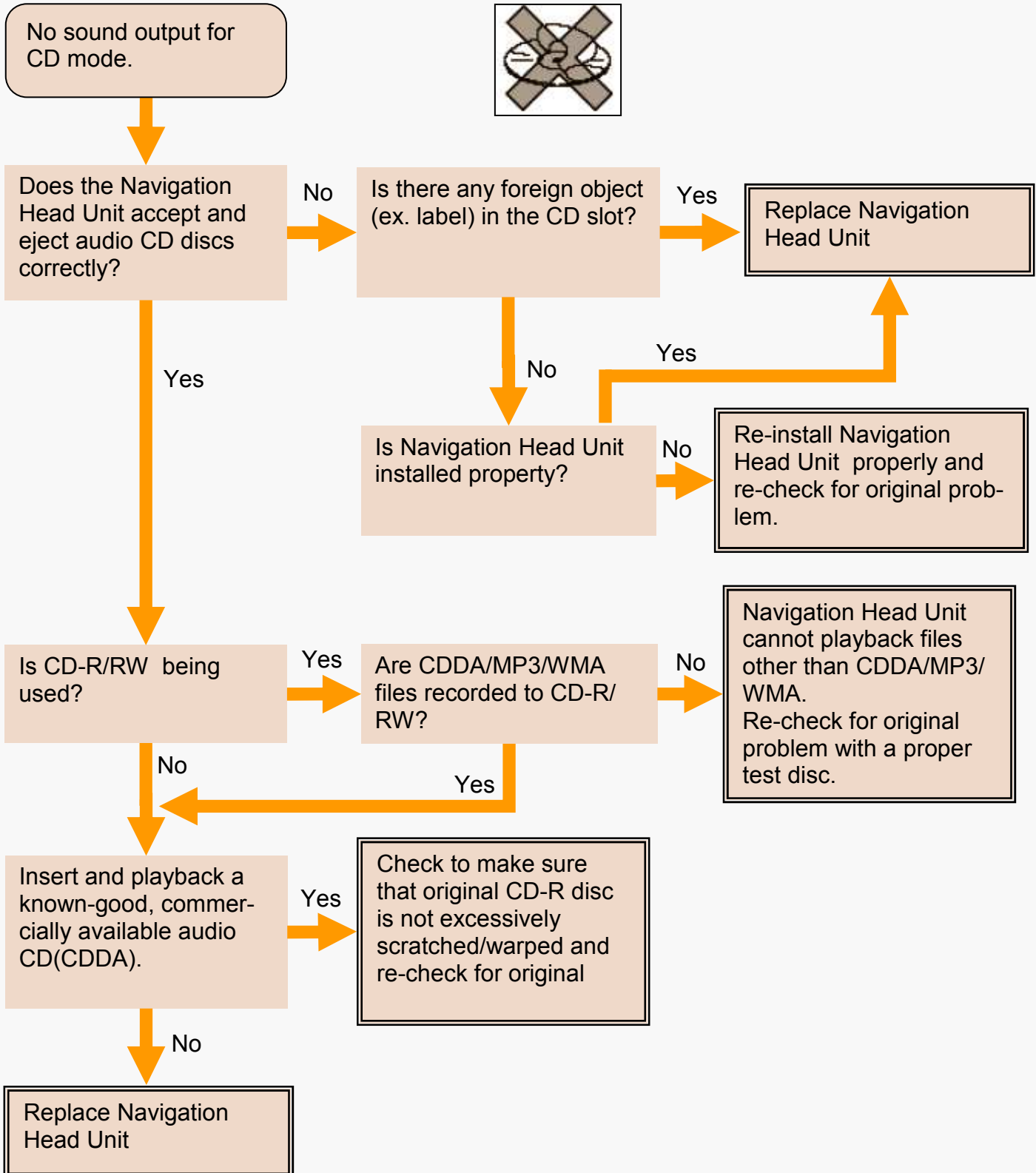

NO SOUND (USB)

Condition: No sound on only USB mode

No sound output for USB mode.

Does USB memory have MP3/WMA files?

No

The Navigation Head Unit only playback MP3/WMA files in USB mode.

Yes

Check the USB connectivity in diagnostic mode.
Does the indicator display "OK"?

No

Re-connect USB.
Does the diagnostic mode display "OK"?

Yes

No

Switch to USB mode and re-check for original problem.

If the USB has an LED indicator, does this indicator lamp light up when Navigation Head Unit is connected?

Yes

Yes

No

Use a known good USB device containing MP3/WMA files.
Does Navigation Head Unit play the files?

Yes

Original USB drive could be defective.

No

Replace vehicle USB cable with a known-good one and re-check original problem.

Does the same issue occur?

Replace Navigation Head Unit

No

Yes

Original vehicle USB cable is defective and needs to be replaced.

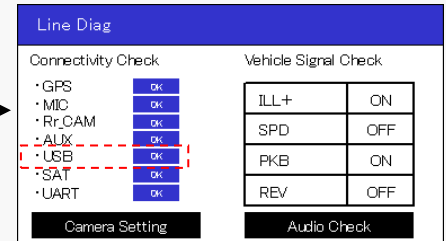

2. Troubleshooting

NO SOUND (iPod)

Condition: No sound only iPod mode

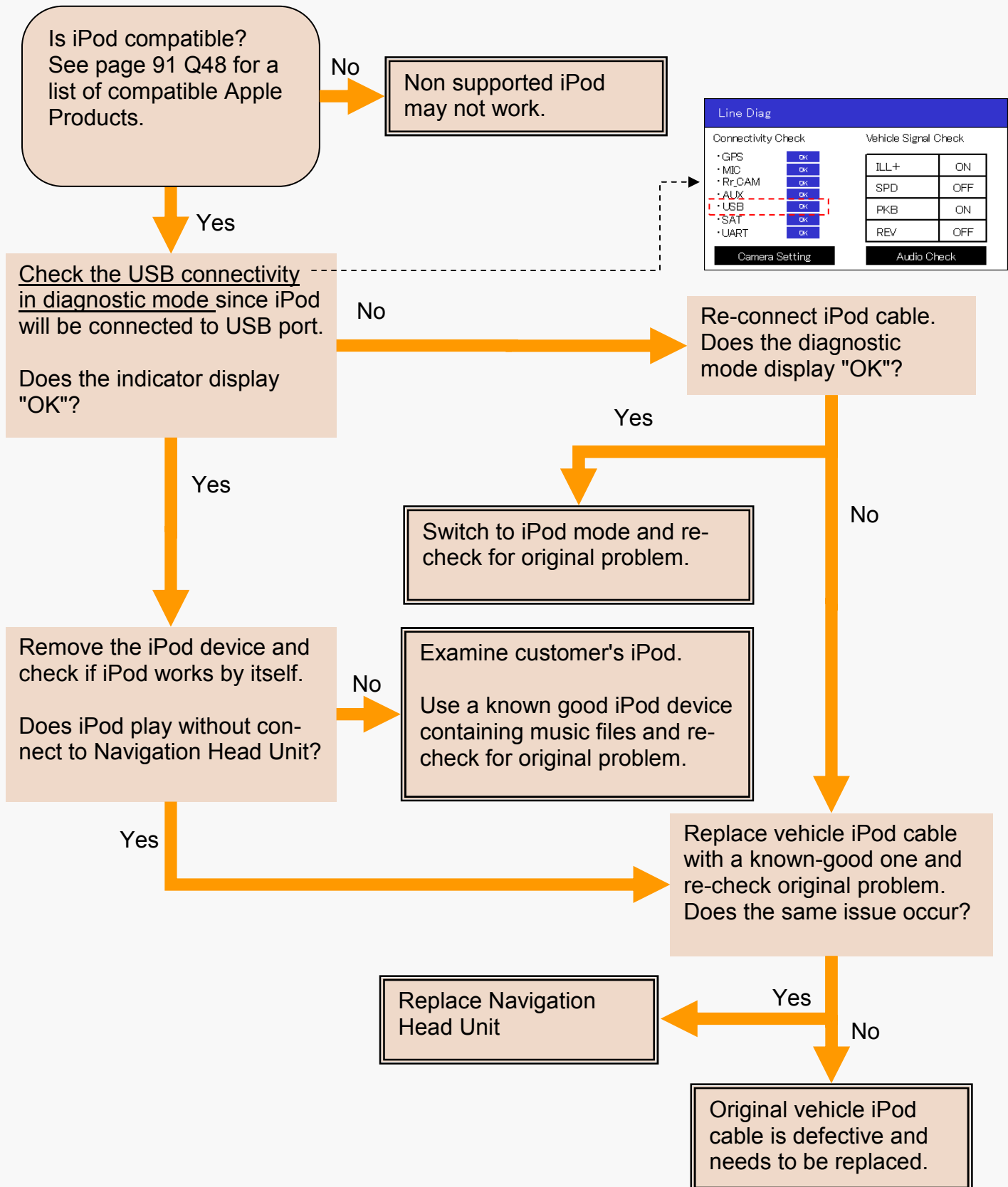

CD SKIP

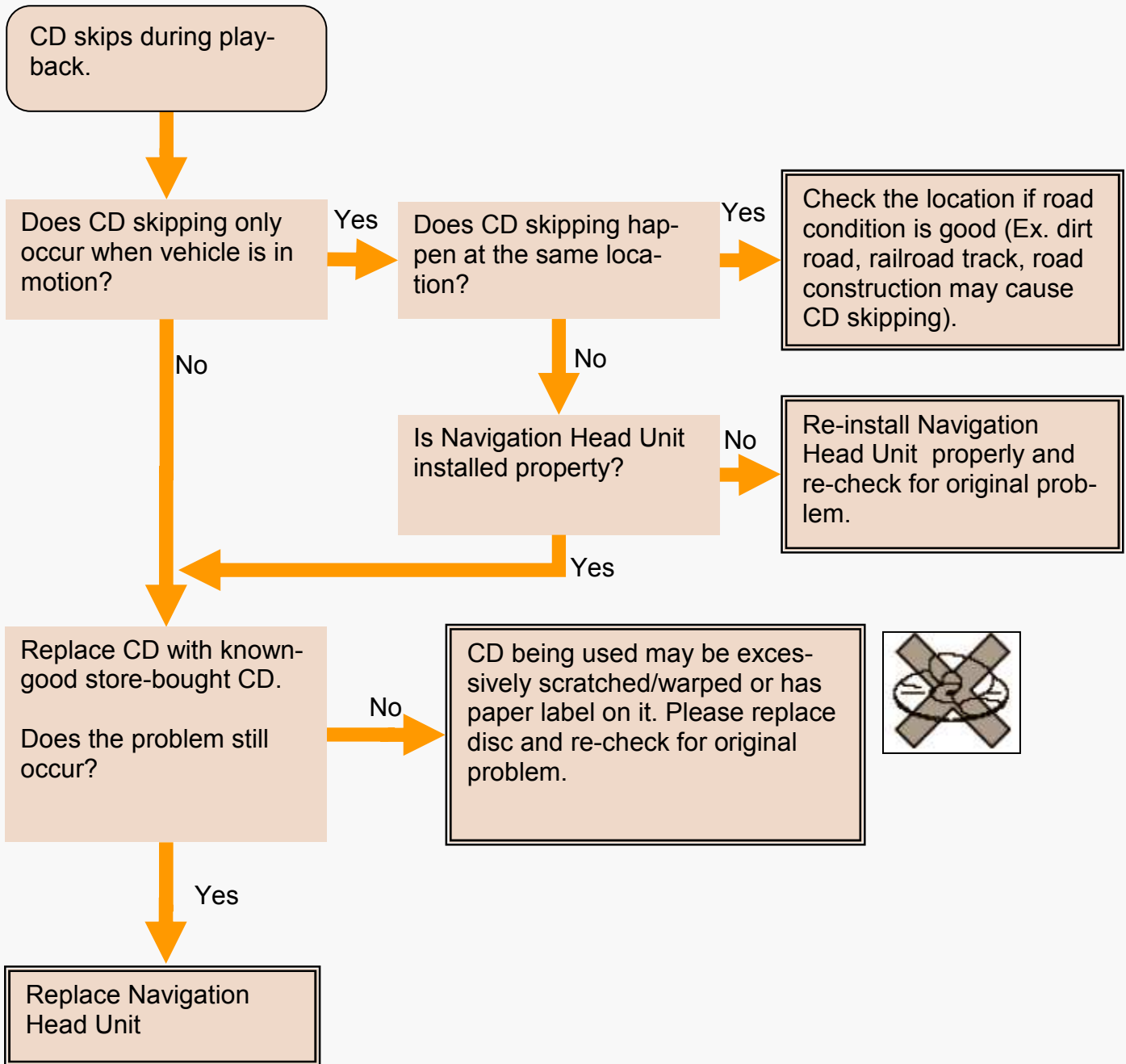

2. Troubleshooting

CD WON'T PLAY CORRECTLY

Condition: CD Skips, CD jumps tracks

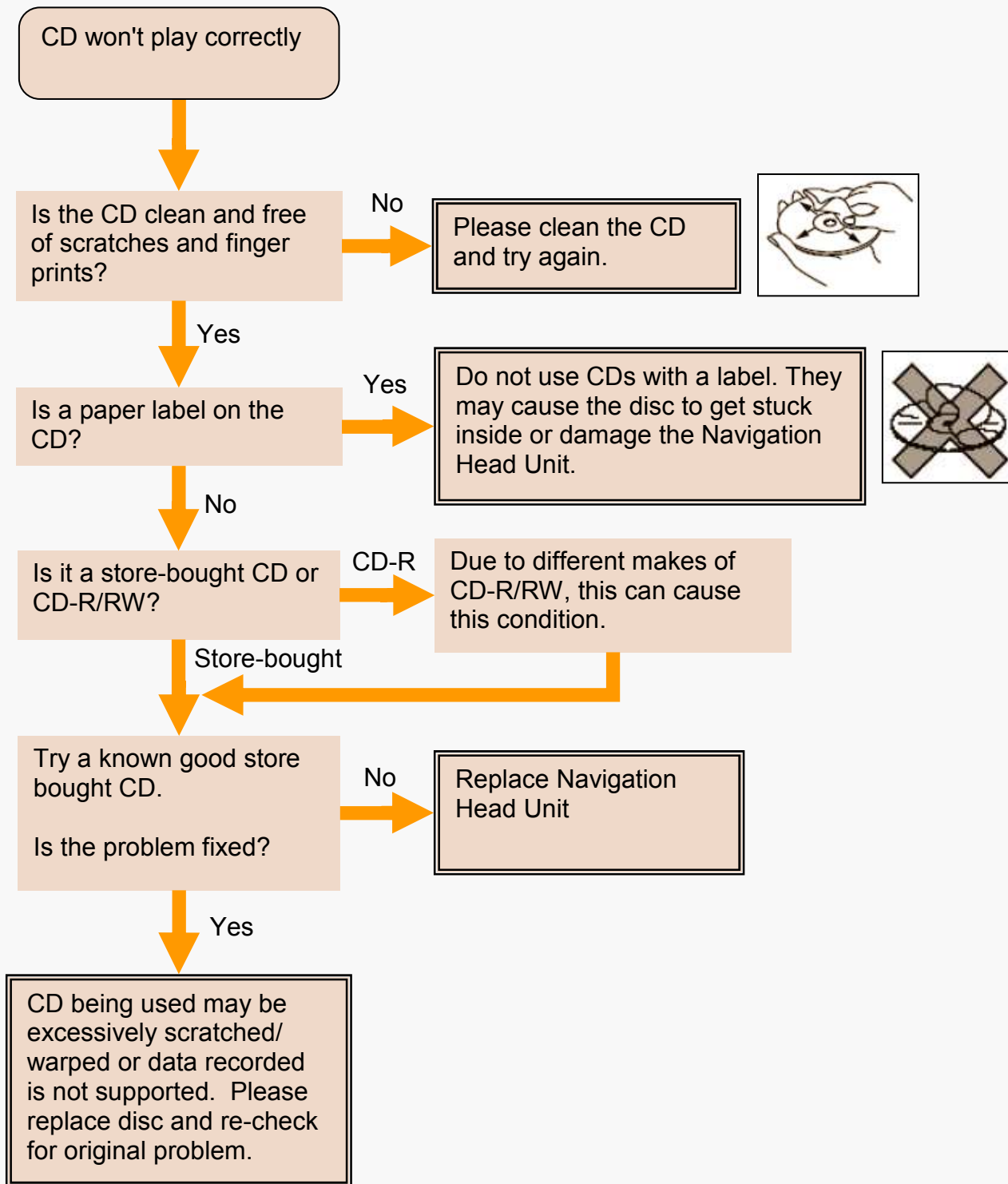

SOUND IS DISCOMFORTING

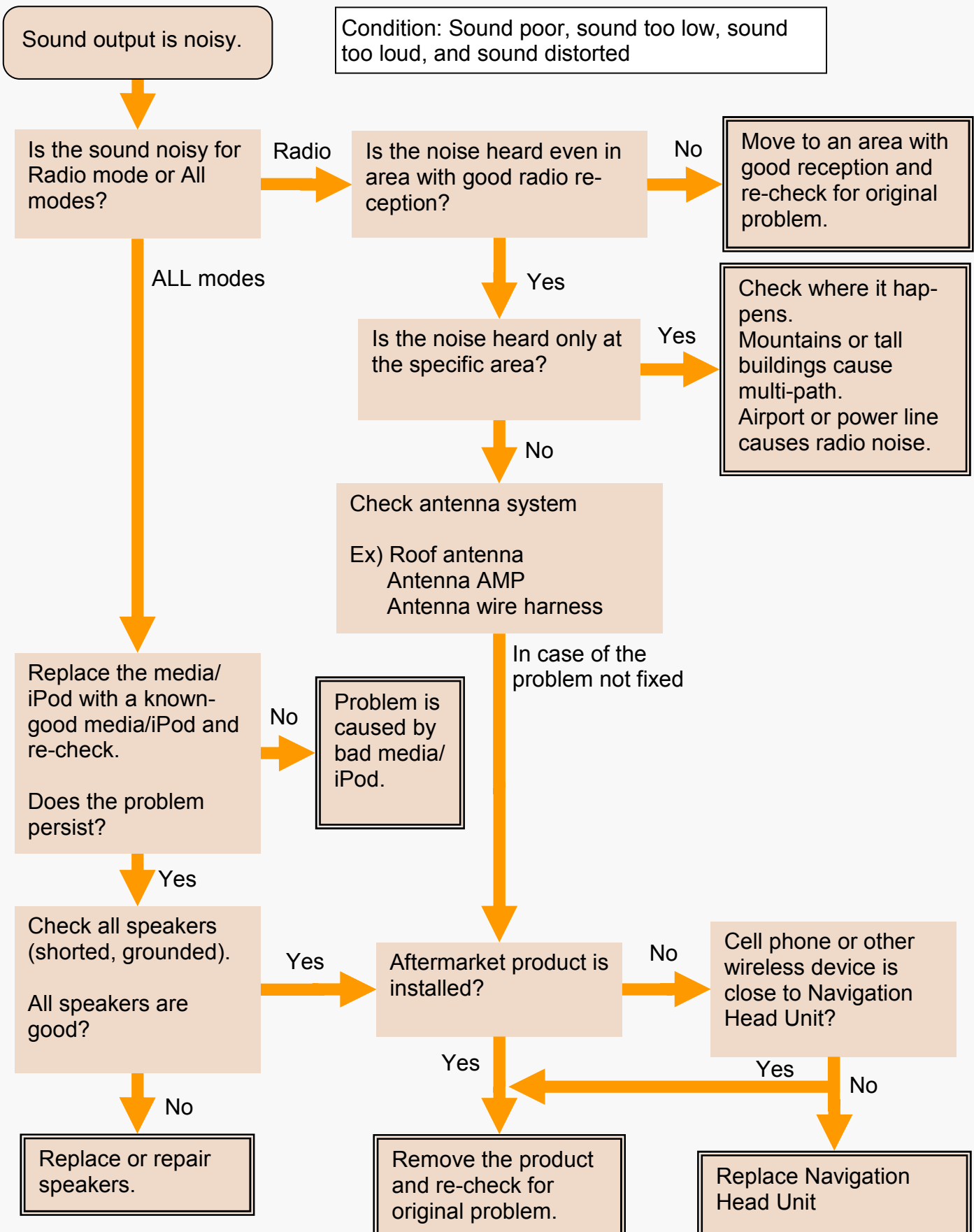

2. Troubleshooting

NO ILLUMINATION

Condition: No front panel button illumination

Front panel illumination doesn't turn ON.

Line Diag	
Connectivity Check	
· GPS	OK
· MIC	OK
· Rr_CAM	OK
· AUX	OK
· USB	OK
· SAT	OK
· UART	OK
Camera Setting	
Vehicle Signal Check	
ILL+	ON
SPD	OFF
PKB	ON
REV	OFF
Audio Check	

Check the ILL+ signal in diagnostic mode.

Does the diagnostic display shows "ON"?

No

Check if the ILL+ wire harnesses is connected correctly.

Does the illumination turn ON?

Yes

The problem was solved.

No

Check ILL +B signal at Navigation Head Unit.
(16P connector D, #10 pin, type 12V when ILL is ON)

Is ILL +B within specification?

No

Vehicle wire harnesses could be defective.

Yes

Does the illumination turn ON?

No

Replace Navigation Head Unit

Yes

The problem was solved.

NO DISPLAY

Condition: No display, no screen backlight

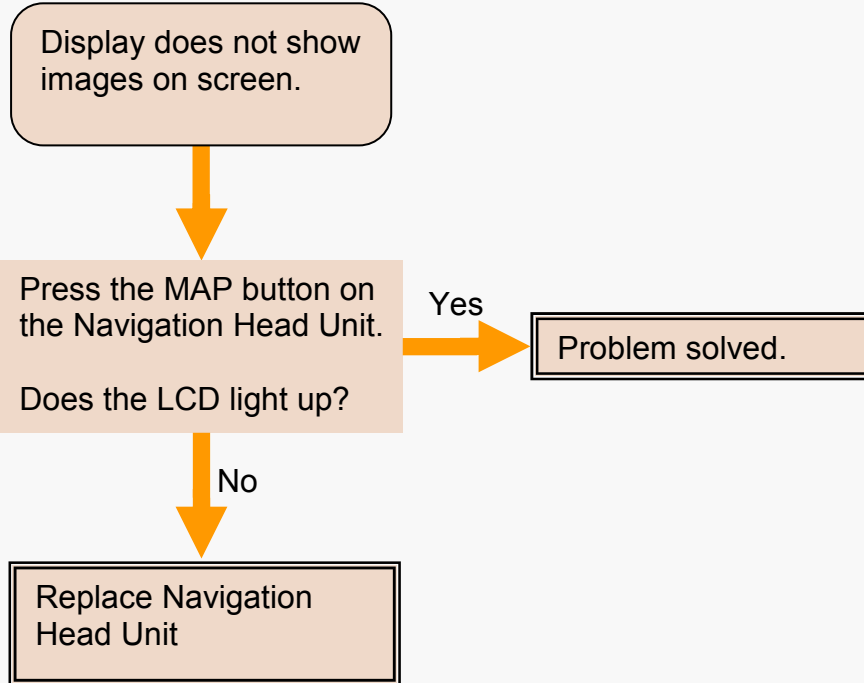

Caution:

Do not remove the display from the main unit portion. Unit is one piece.

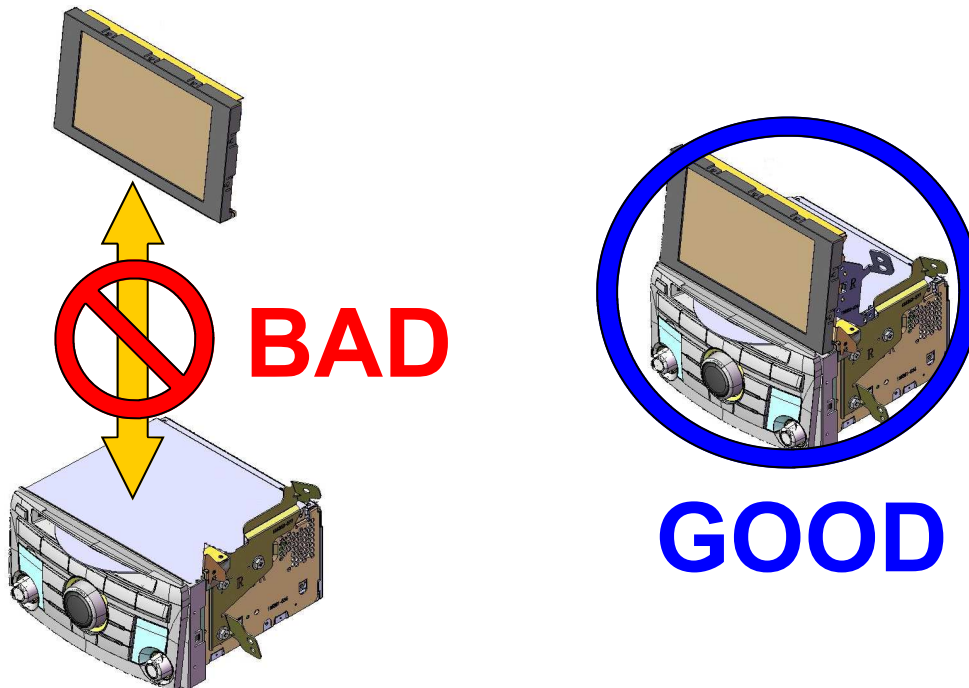

2. Troubleshooting

CURRENT GPS POSITION DOES NOT MOVE

Condition: Vehicle position icon inaccurate, Vehicle position icon doesn't move

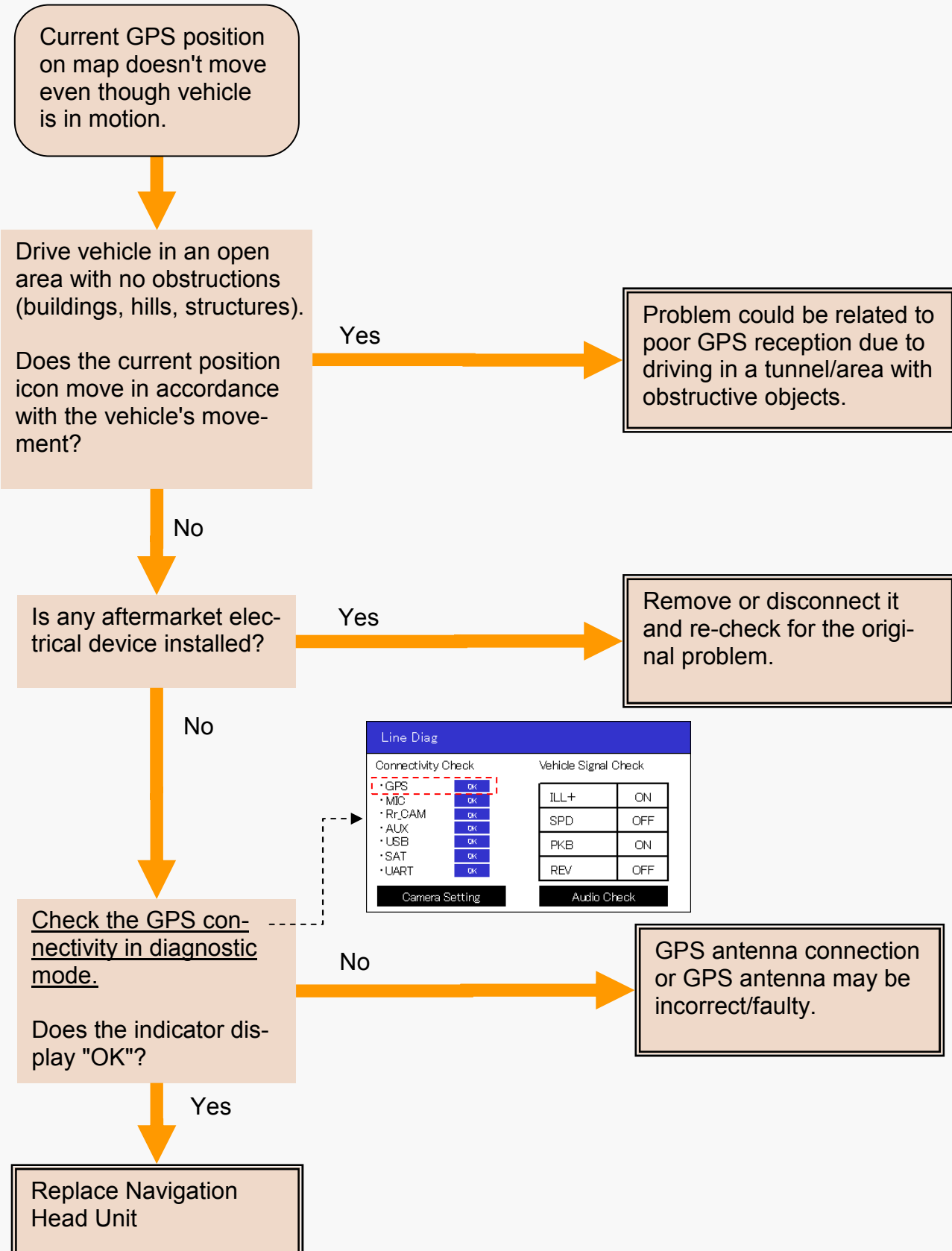

BLUETOOTH DOES NOT WORK

Condition: Bluetooth device will not pair to the system

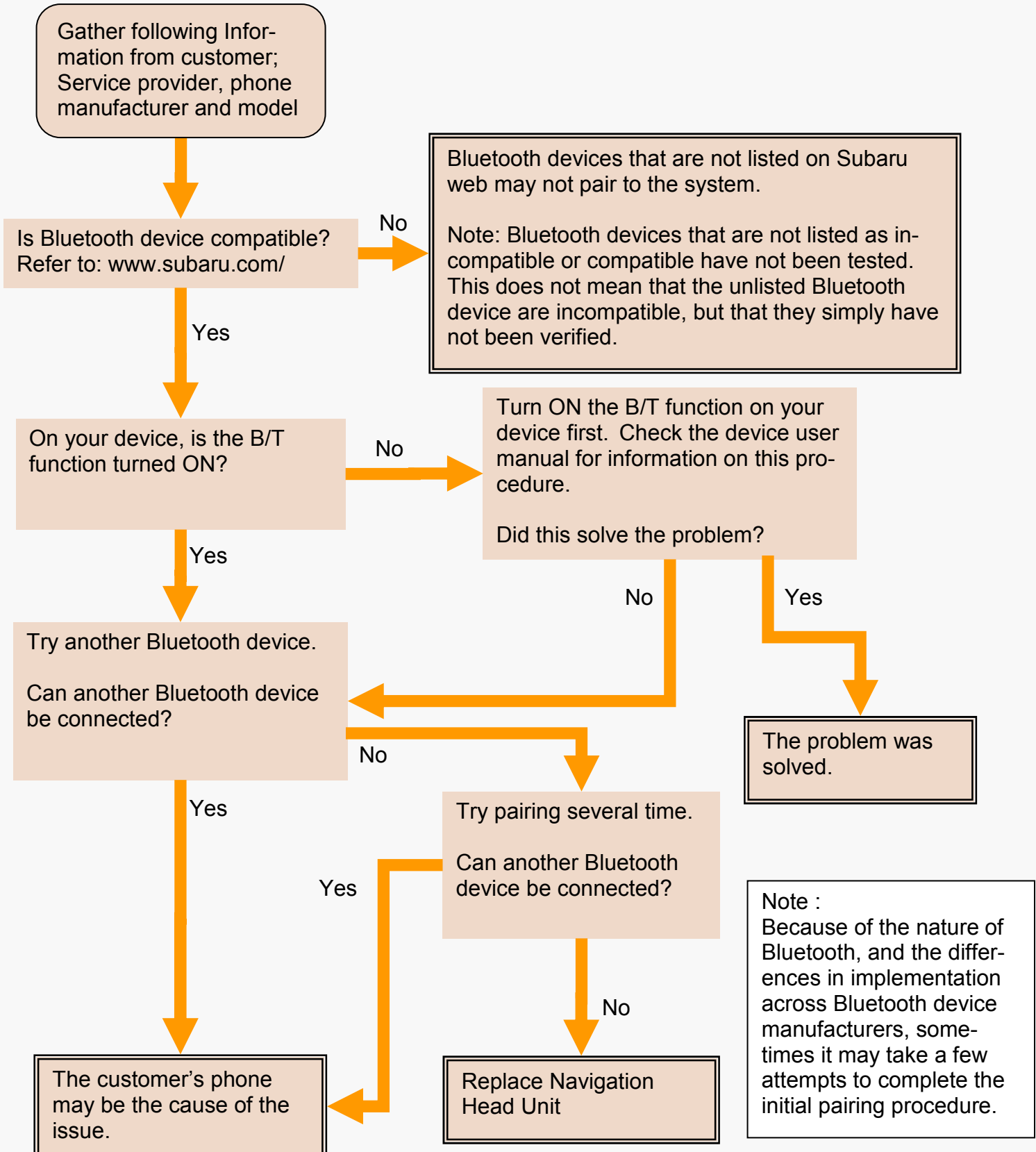

2. Troubleshooting

REAR VIEW CAMERA WON'T DISPLAY

Condition: Rear View video not shown

Rear view camera won't display or gets a noise in the display.

Press the MAP button on the Navigation Head Unit. Did the map display clear view?

Yes

When the vehicle is in reverse, does the map change to other view?

Yes

Check the rear view camera and re-connect. And check the connectivity in diagnostic mode. If it will not restored, rear view camera needs to be examined and/or re-

No

Check the REV connectivity in diagnostic mode.

When reverse gear is selected, does REV show "ON"?

No

Check the reverse harness or vehicle side condition.

Yes

Check CA + signal at Navigation Head Unit. (16P connector B, #7 pin, type 6V when reverse gear is ON)
Is CA + within specification?

Yes

Check CA+ at camera. Is CA+ within specification?

No

Yes

Check the rear view camera and re-connect. If it will not restored, rear view camera needs to be examined and/or replaced.

No

Replace Navigation Head Unit

Line Diag	
Connectivity Check	
• GPS	OK
• MIC	OK
• Rr.CAM	OK
• AUX	OK
• USB	OK
• SAT	OK
• UART	OK
Vehicle Signal Check	
ILL+	ON
SPD	OFF
PKB	ON
REV	OFF
Camera Setting	Audio Check

AHA RADIO - Caution Message (1)

Caution Message:

Please make sure the Aha app is running on your mobile device.

*Note:
Aha Radio is not available for
86271AJ67A and 86271AJ77A*

Symptoms:

- Aha application shuts down by itself
- Unable to enter Aha Mode

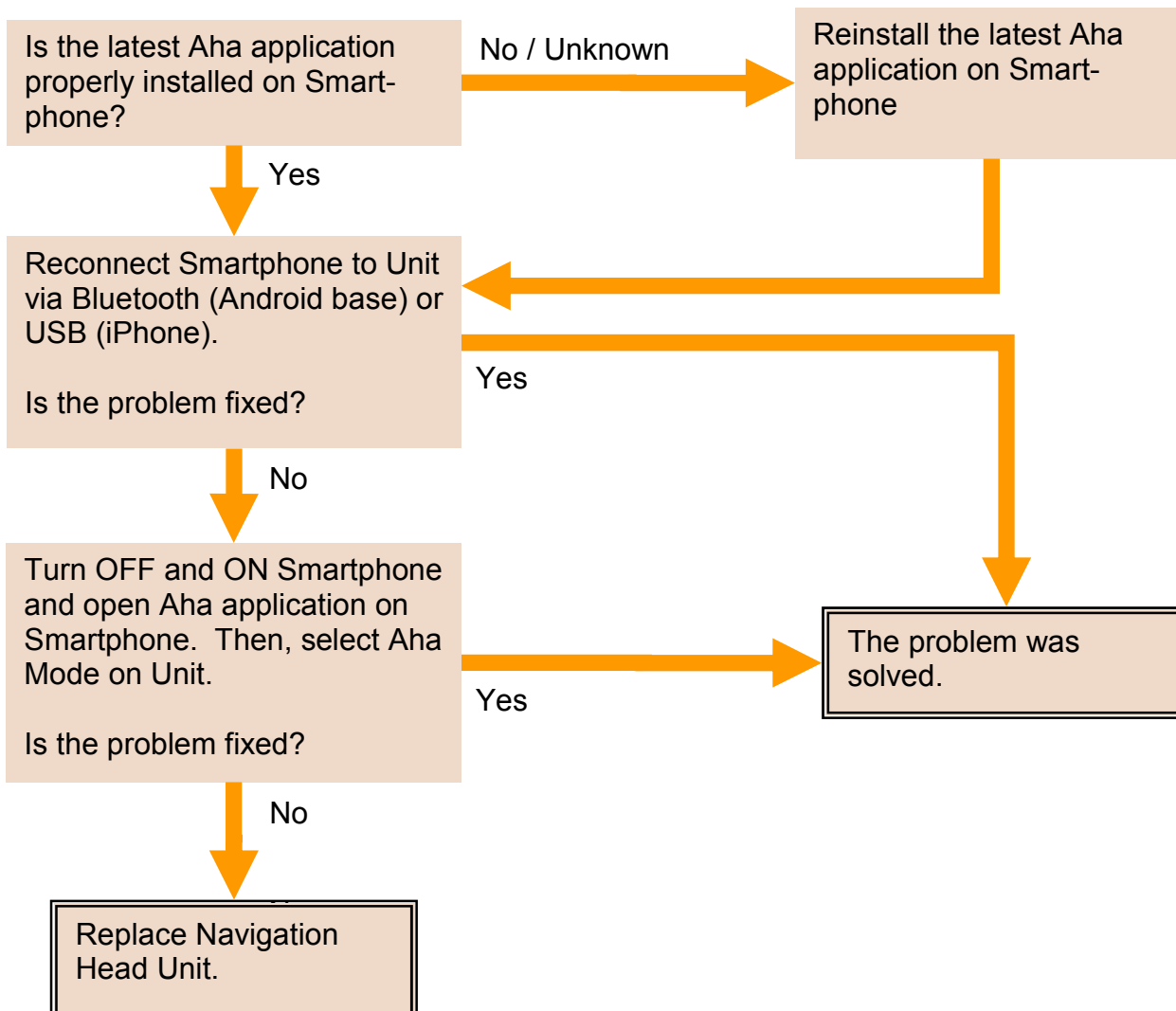

2. Troubleshooting

AHA RADIO - Caution Message (2)

Caution Message:

Please update your Aha application.

*Note:
Aha Radio is not available for
86271AJ67A and 86271AJ77A*

Symptom:

Unable to enter Aha Mode

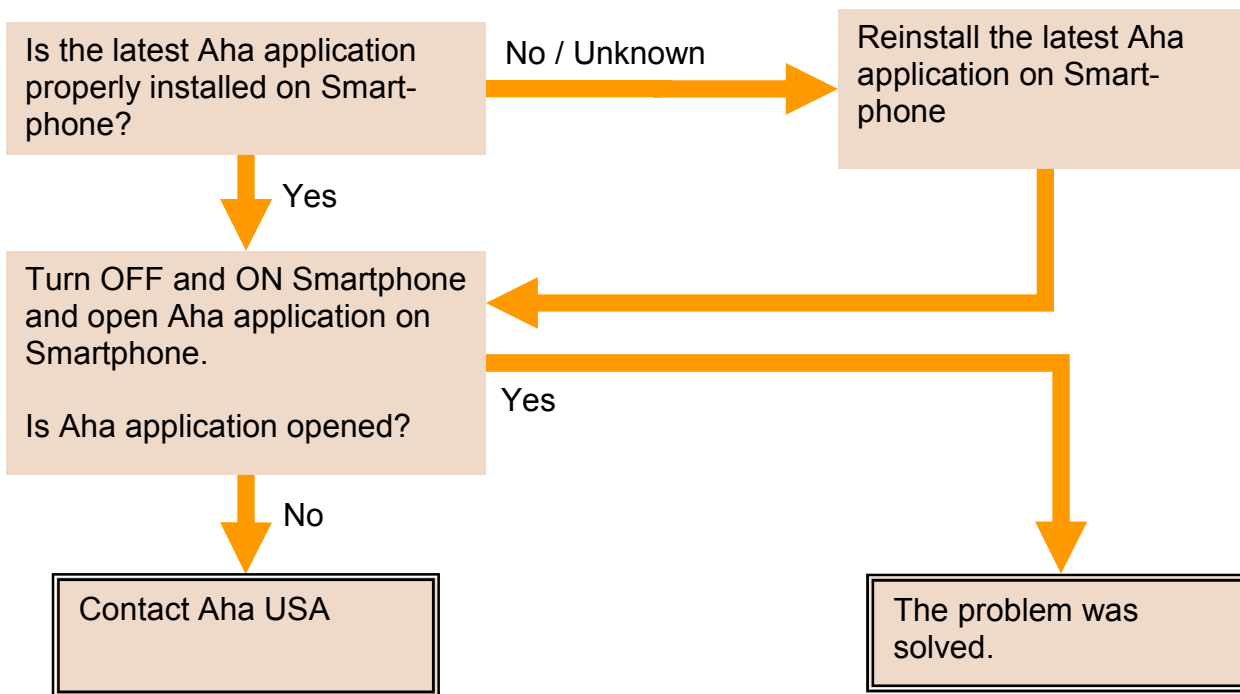

AHA RADIO - Caution Message (3)

Caution Message:

Please reconnect mobile device.

*Note:
Aha Radio is not available for
86271AJ67A and 86271AJ77A*

Symptom:

Unable to enter Aha Mode on vehicle Navigation Head Unit

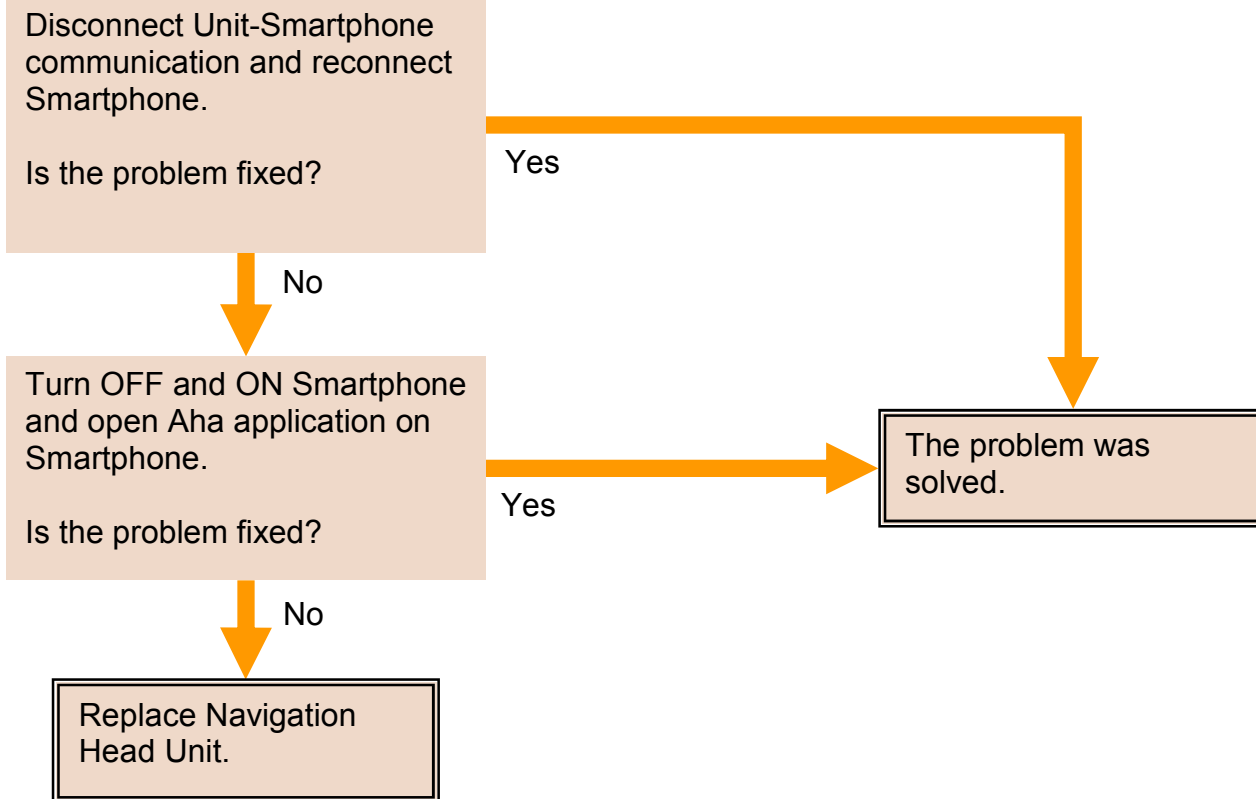

2. Troubleshooting

AHA RADIO - Caution Message (4)

Caution Message:

Poor wireless reception.

*Note:
Aha Radio is not available for
86271AJ67A and 86271AJ77A*

Symptoms:

- Programs are not played on vehicle Navigation Head Unit
- Images are not shown on vehicle Navigation Head Unit

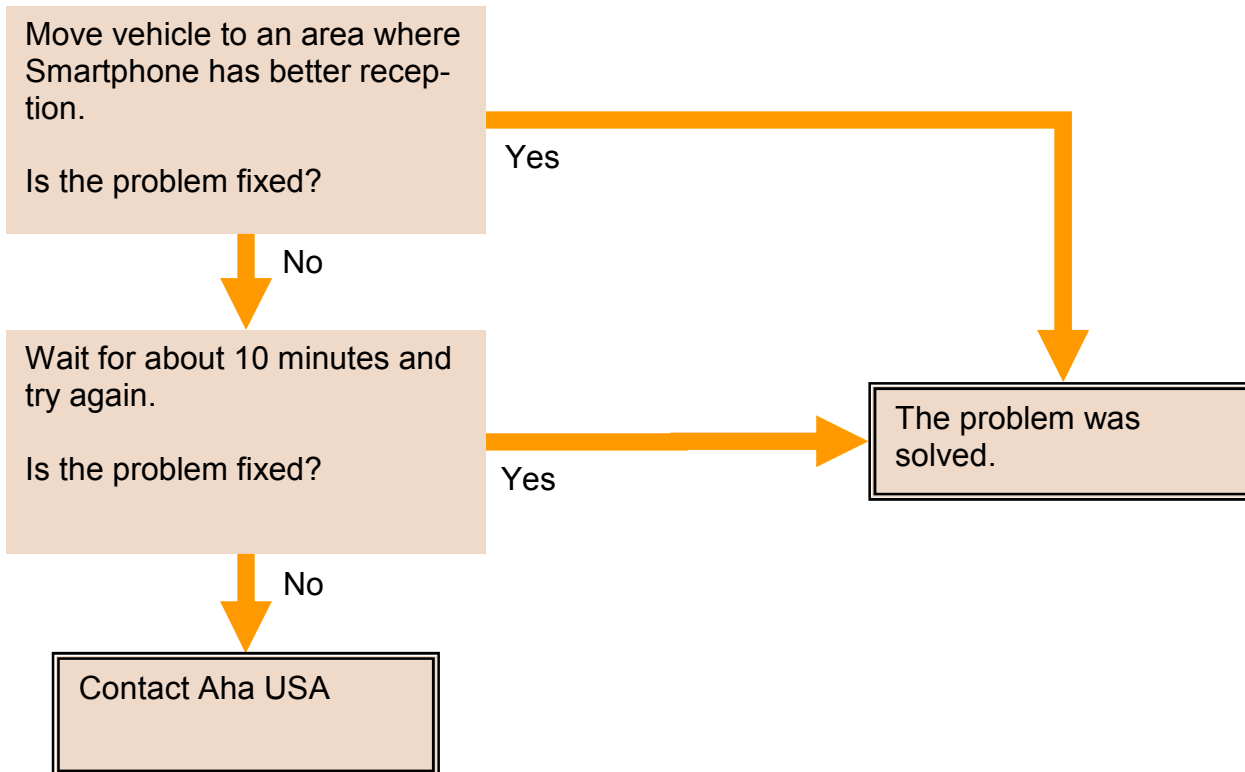

AHA RADIO - Caution Message (5)

Caution Message:

Entry not recognized.

*Note:
Aha Radio is not available for
86271AJ67A and 86271AJ77A*

Symptom:

All Aha Mode functions on vehicle Navigation Head Unit do not work

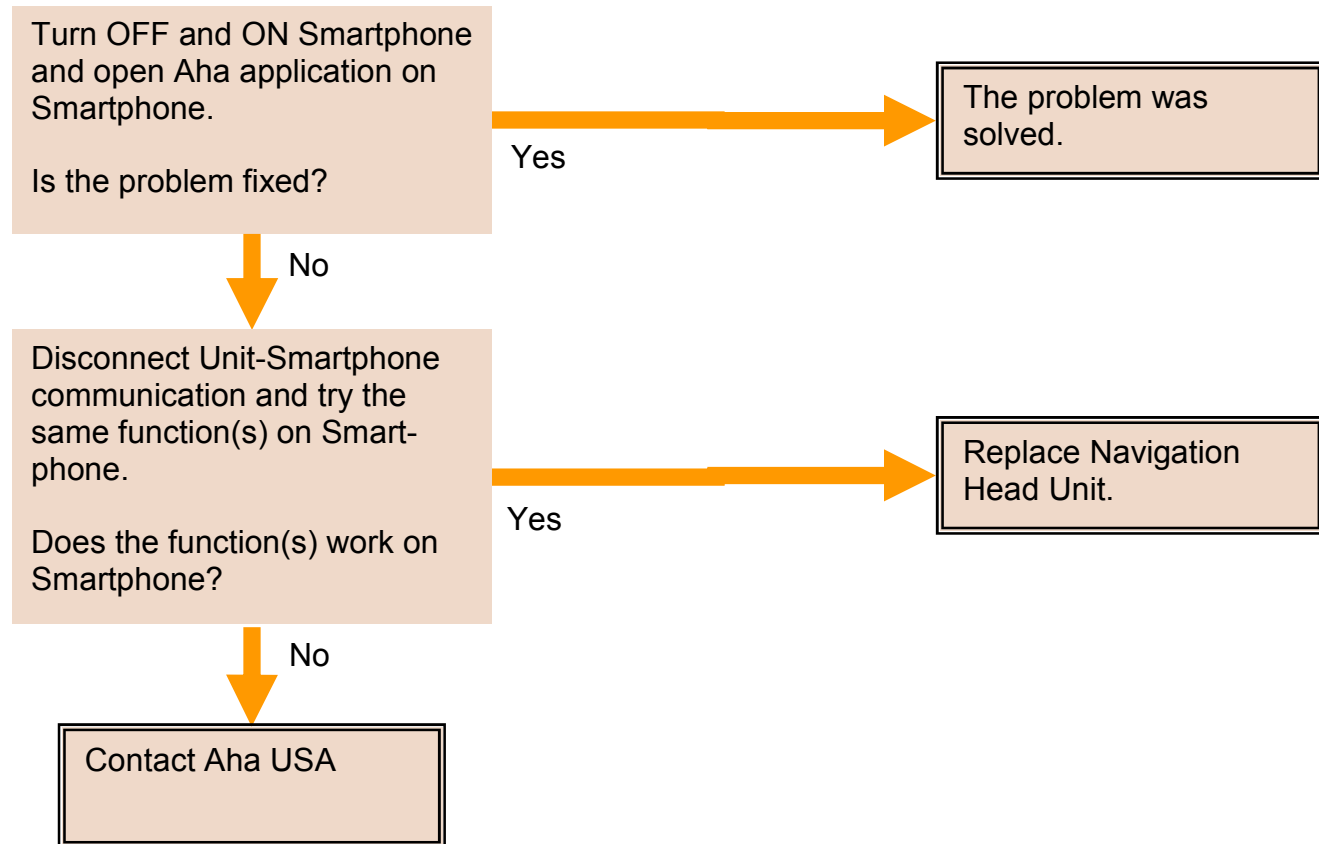

2. Troubleshooting

AHA RADIO - Caution Message (6)

Caution Message:

Please login to the Aha app on the mobile device.

*Note:
Aha Radio is not available for
86271AJ67A and 86271AJ77A*

Symptom:

Unable to enter Aha Mode on vehicle
Navigation Head Unit

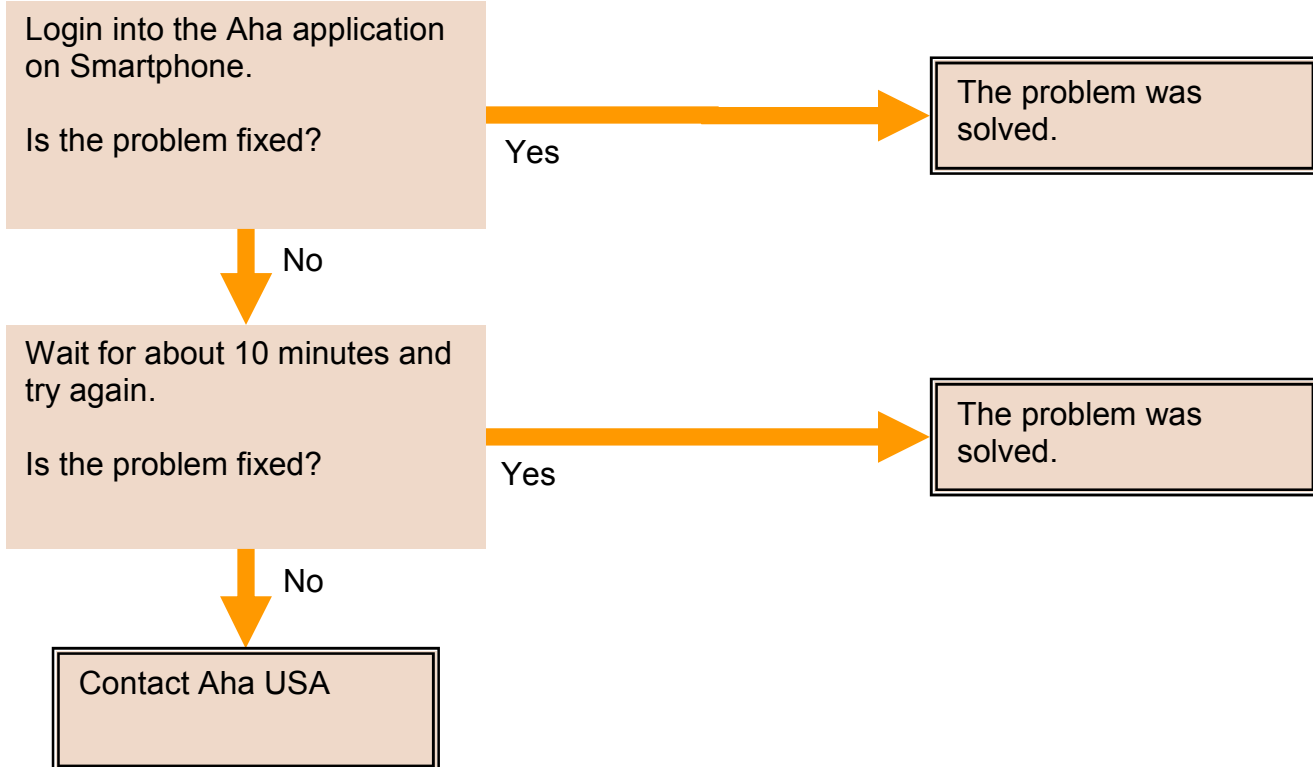

AHA RADIO - Caution Message (7)

Caution Message:

The station list cannot be acquired.

*Note:
Aha Radio is not available for
86271AJ67A and 86271AJ77A*

Symptom:

Aha Radio Station List is not shown on vehicle Navigation Head Unit

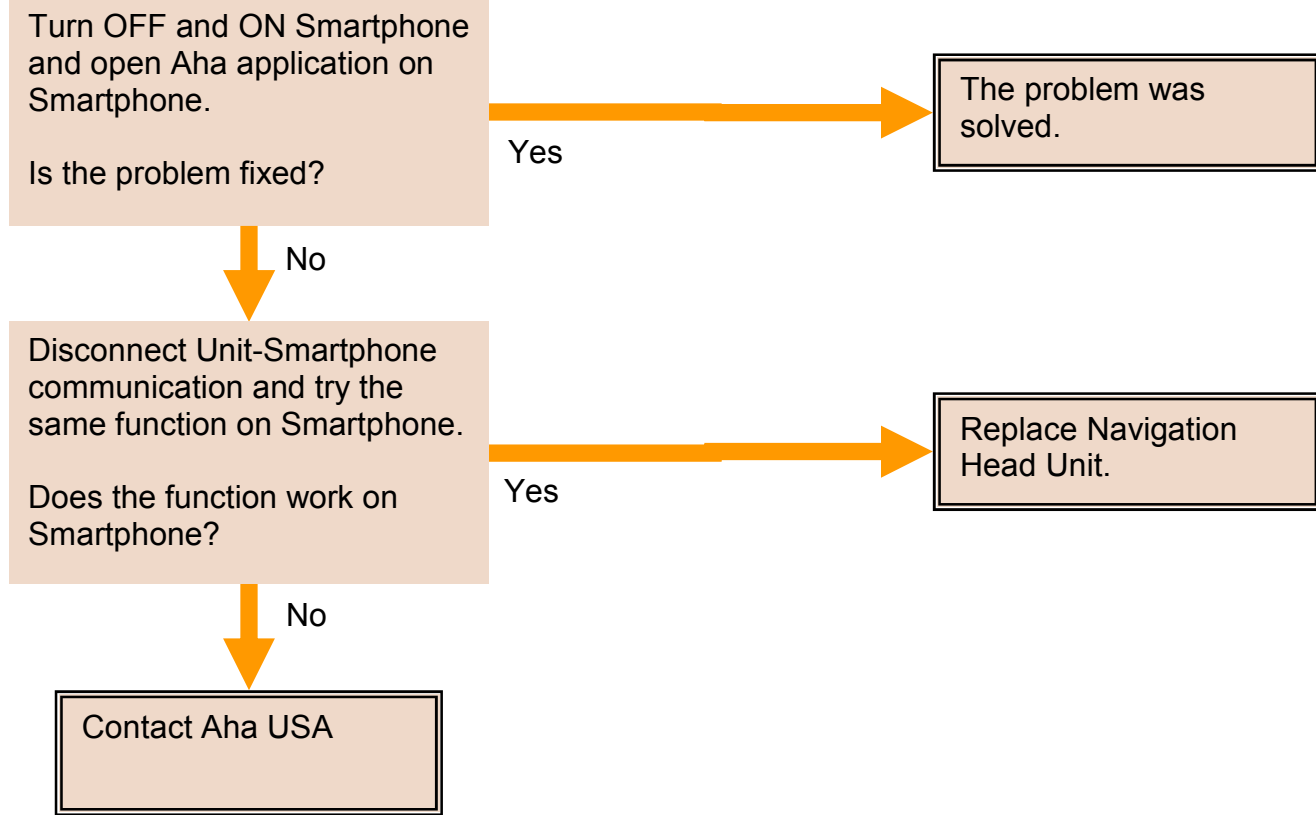

2. Troubleshooting

AHA RADIO - Caution Message (8)

Caution Message:

The content cannot be acquired.

Note:
Aha Radio is not available for
86271AJ67A and 86271AJ77A

Symptom:

Aha Radio Content is not shown on vehicle Navigation Head Unit

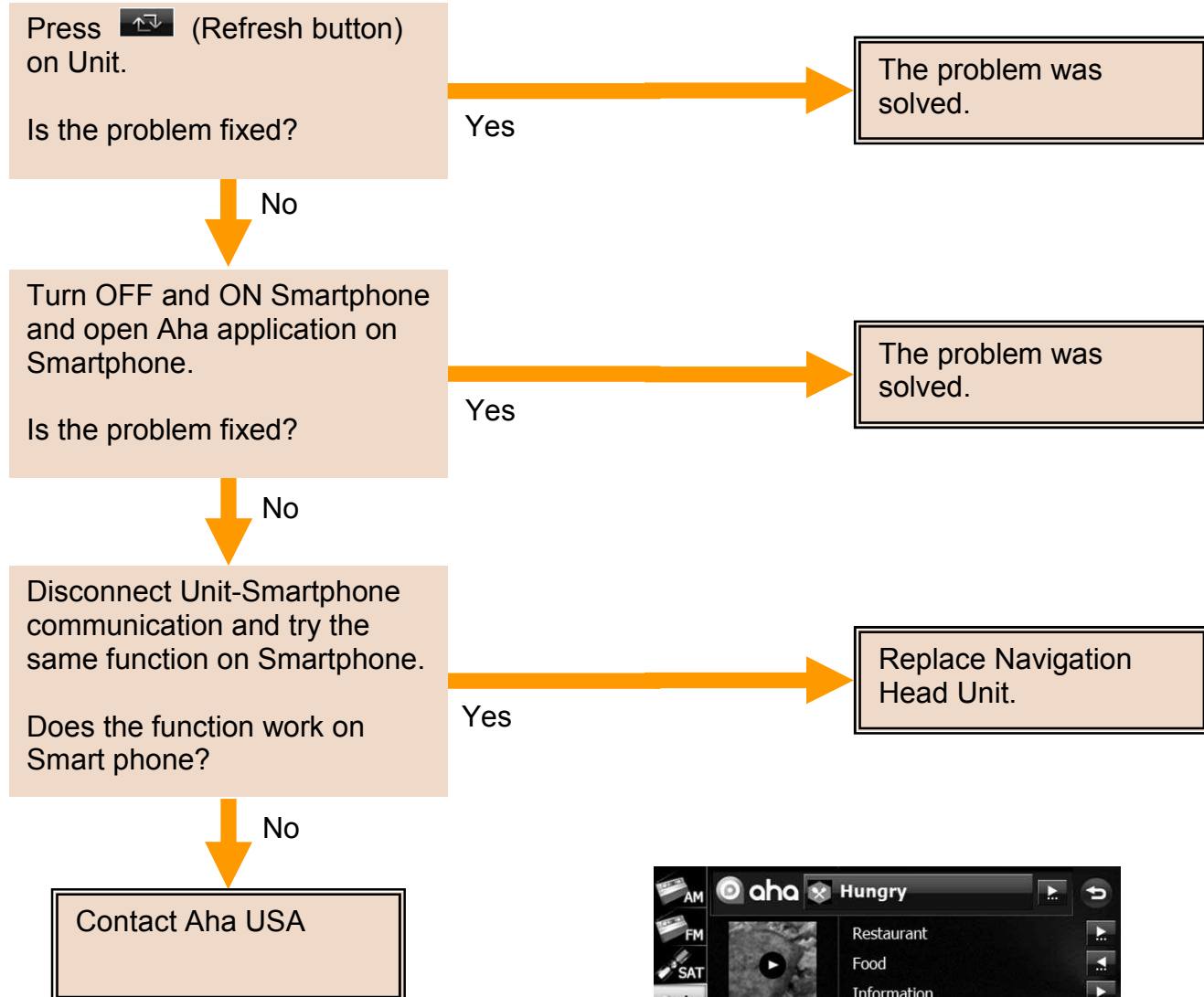

Refresh button

AHA RADIO - Caution Message (9)

Caution Message:

Information acquisition error.

Note:
Aha Radio is not available for
86271AJ67A and 86271AJ77A

Symptom:

Aha Radio Icons or Logos are not shown on vehicle Navigation Head Unit

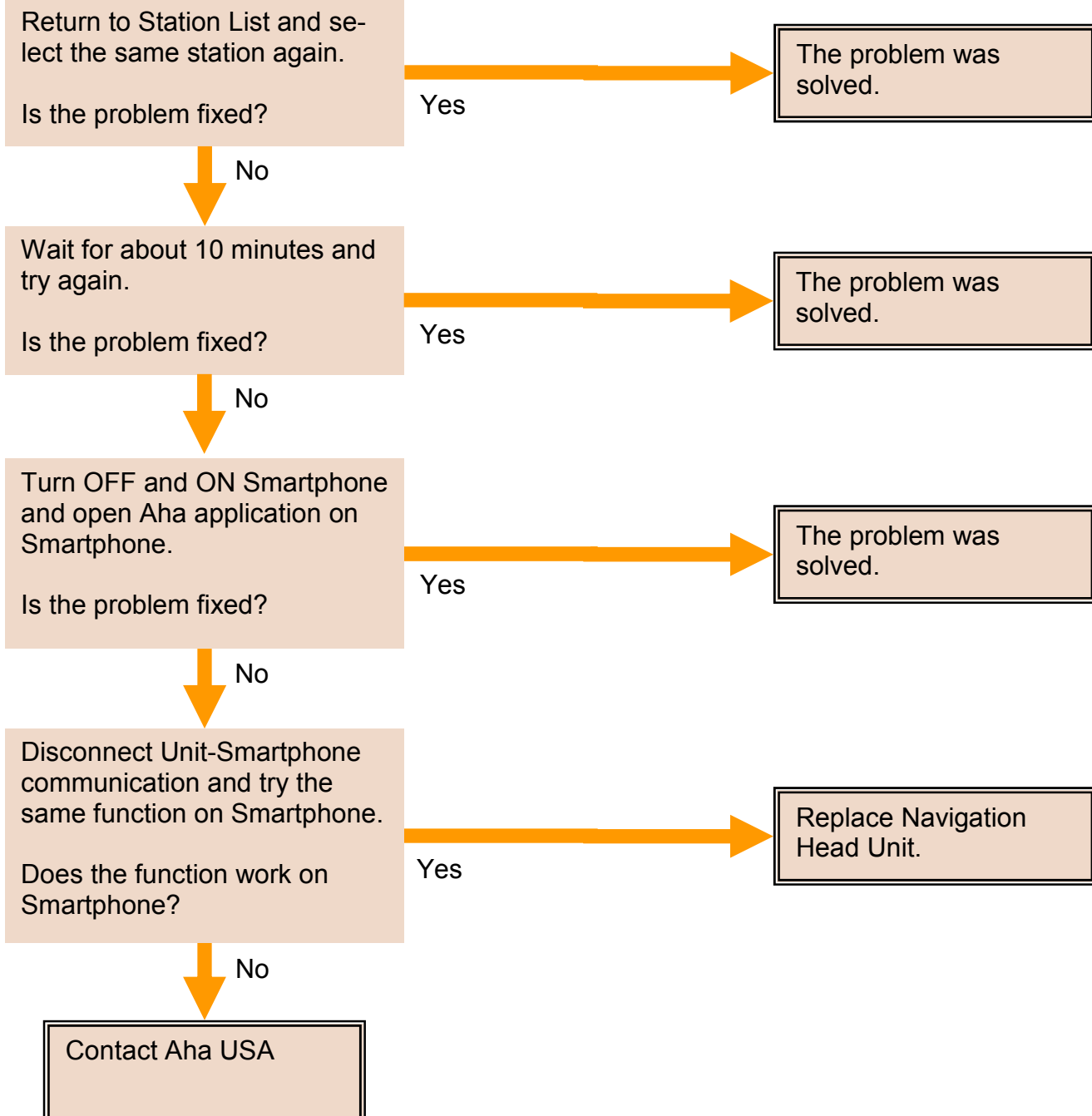

2. Troubleshooting

AHA RADIO - Caution Message (10)

Caution Message:

Action not available.

Note:
Aha Radio is not available for
86271AJ67A and 86271AJ77A

Symptom:

- All Aha Mode functions do not work on vehicle Navigation Head Unit
- Forward/Reverse functions do not work on vehicle Navigation Head Unit

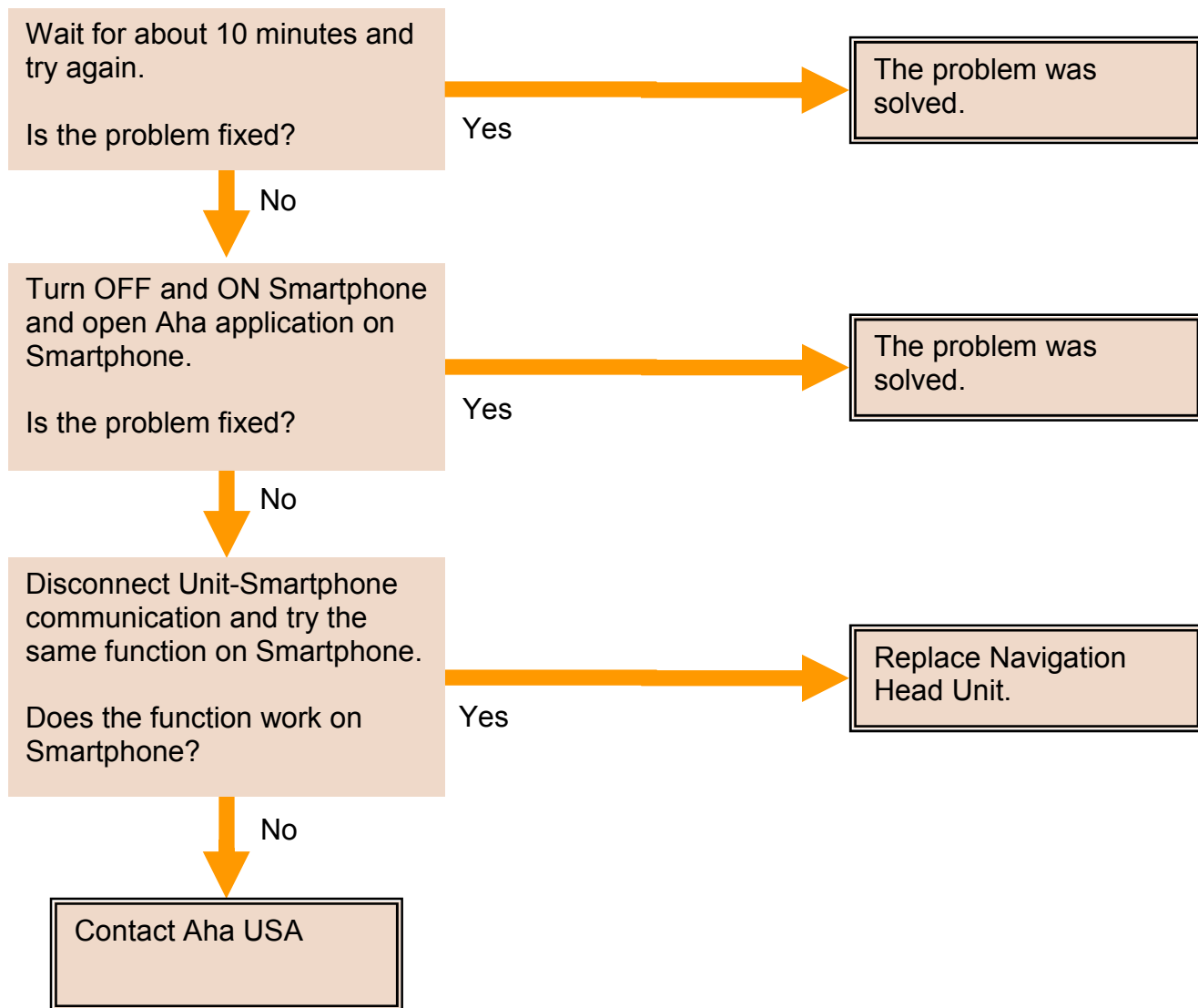

AHA RADIO - Caution Message (11)

Caution Message:

Aha Server Error - Please check connection or reception.

*Note:
Aha Radio is not available for
86271AJ67A and 86271AJ77A*

Symptom:

Aha Radio content cannot be played on vehicle Navigation Head Unit

Move vehicle to an area where Smartphone has better reception.
Is the problem fixed?

Yes

The problem was solved.

No

Wait for about 10 minutes and try again.
Is the problem fixed?

Yes

The problem was solved.

No

Contact Aha USA

2. Troubleshooting

AHA RADIO - Caution Message (12)

Caution Message:

Aha Server Down - Please try again later.

Note:
Aha Radio is not available for
86271AJ67A and 86271AJ77A

Symptom:

Aha Radio content cannot be played on
vehicle Navigation Head Unit

Wait for about 10 minutes and
try again.

Is the problem fixed?

Yes

The problem was
solved.

No

Contact Aha USA

AHA RADIO - Caution Message (13)

Caution Message:

Aha Station Contents Not Available - Please Try Again Later.

Note:
Aha Radio is not available for
86271AJ67A and 86271AJ77A

Symptom:

Aha Radio content cannot be played on vehicle Navigation Head Unit

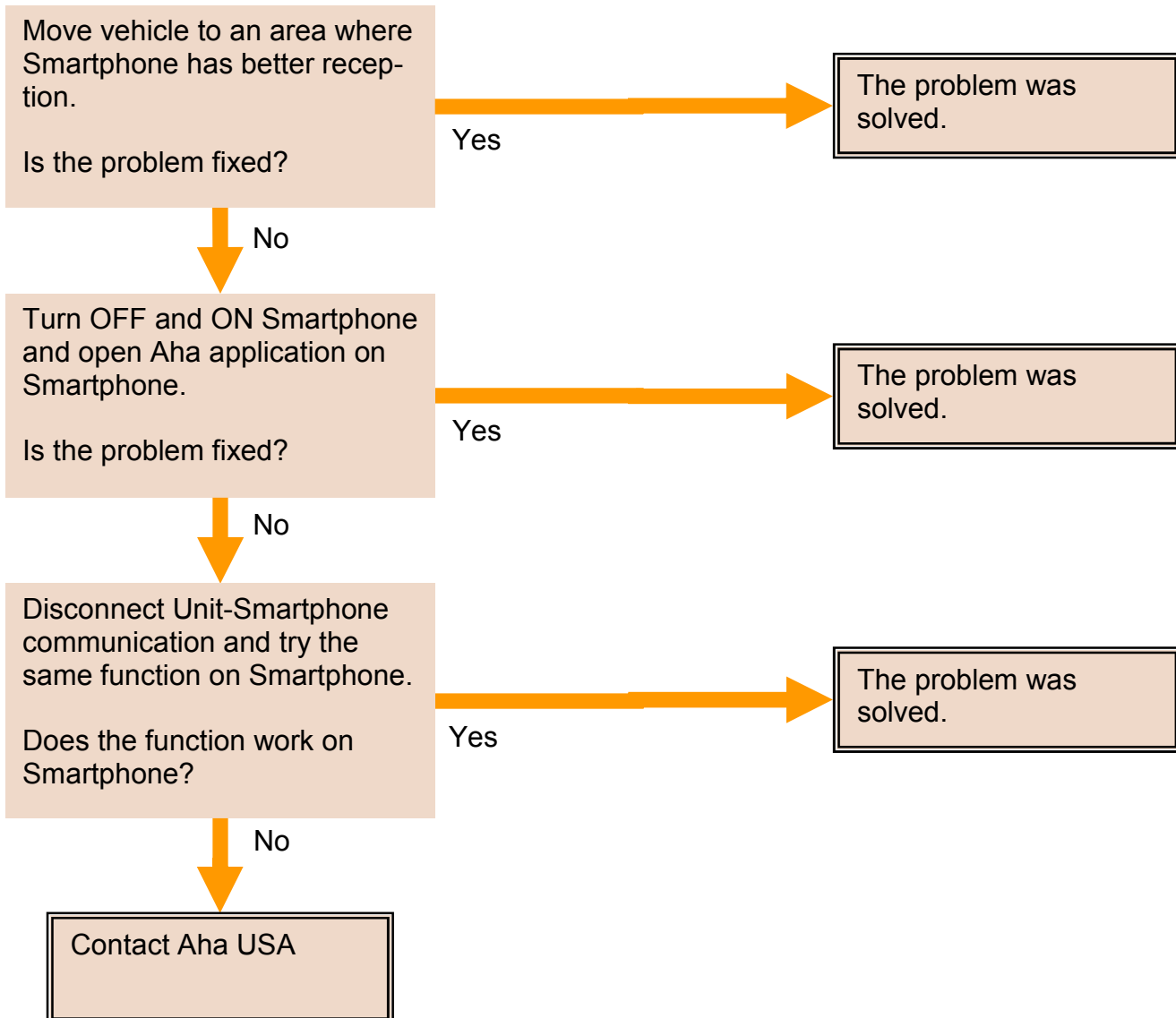

2. Troubleshooting

AHA RADIO - Caution Message (14)

Caution Message:

Aha Communication Error - Please Check Owner's Manual.

*Note:
Aha Radio is not available for
86271AJ67A and 86271AJ77A*

Symptom:

Aha Radio content cannot be played on vehicle Navigation Head Unit

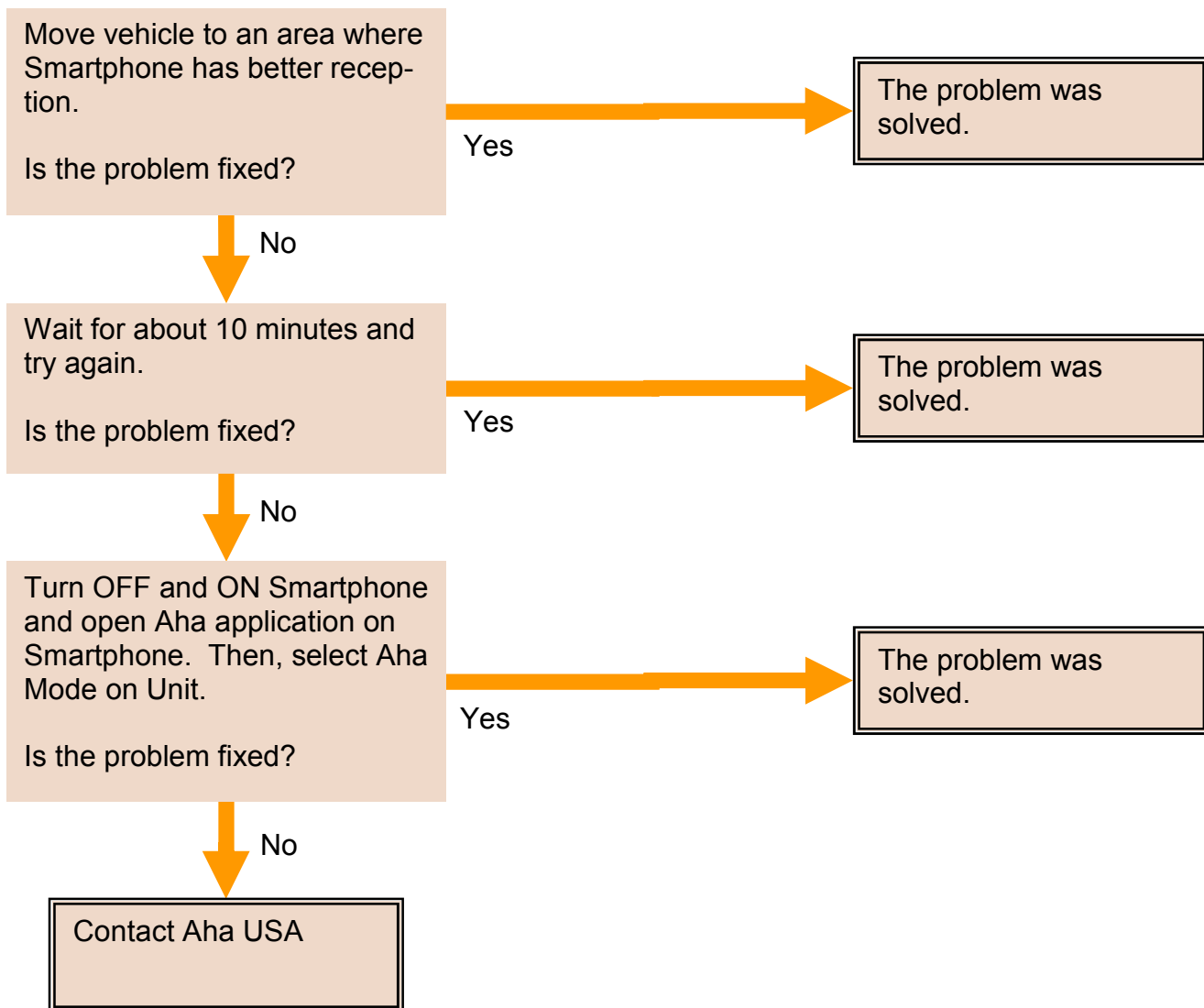

AHA RADIO - Caution Message (15)

Caution Message:

Failed.

Note:

Aha Radio is not available for 86271AJ67A and 86271AJ77A

Symptom:

Map is not updated when pressing "Map Update" button of Aha Radio on vehicle Navigation Head Unit



Map Update Button

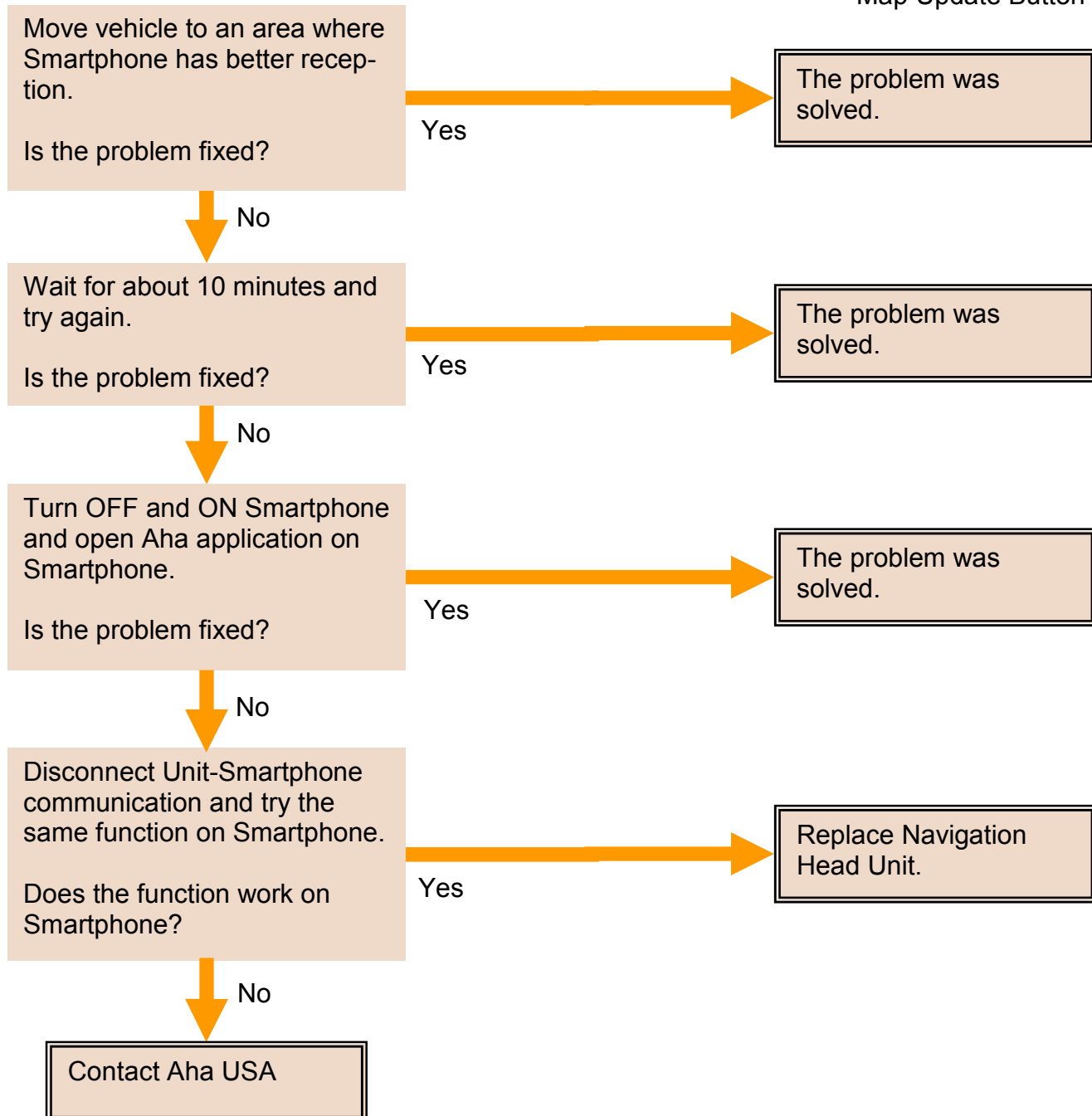

2. Troubleshooting

AHA RADIO - Caution Message (16)

Caution Message:

Please select the type of connection in 'Aha Radio Setting'.

*Note:
Aha Radio is not available for
86271AJ67A and 86271AJ77A*

Condition:

Android device is connected via Bluetooth and iPhone (iOS) is connected via USB

Select the appropriate setting from the two connections available on Aha Radio Setting screen.

Is the problem fixed?

Yes

The problem was solved.

No

Replace Navigation Head Unit.

How to change "Aha Radio Setting":

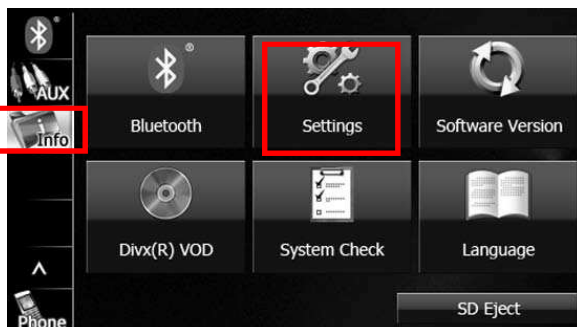

1. Press "INFO" and select "Settings"



2. Select "iOS" or "Bluetooth"

AHA RADIO - Caution Message (17)

Caution Message:

To use this function, you must agree to the terms and condition on the 'caution' screen.

Note:
Aha Radio is not available for
86271AJ67A and 86271AJ77A

Symptom:

Map is not shown when pressing  button

Press "MAP" button on Navigation Head Unit and press "Accept" on the display.

Is the problem fixed?

Yes

The problem was solved.

No

Replace Navigation Head Unit.

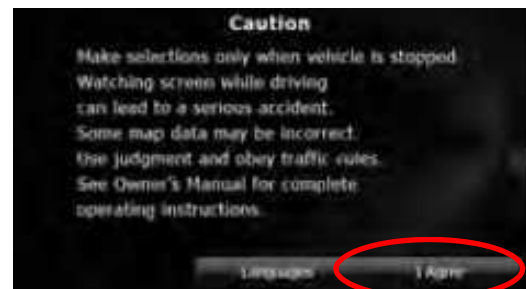
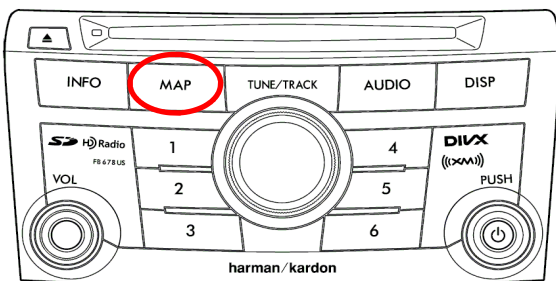

2. Troubleshooting

AHA RADIO - Caution Message (18)

Caution Message:

**'Aha Radio Setting' change failed.
Please try again later.**

Note:
Aha Radio is not available for
86271AJ67A and 86271AJ77A

Symptom:

Aha Radio Setting on vehicle Navigation Head Unit cannot be changed

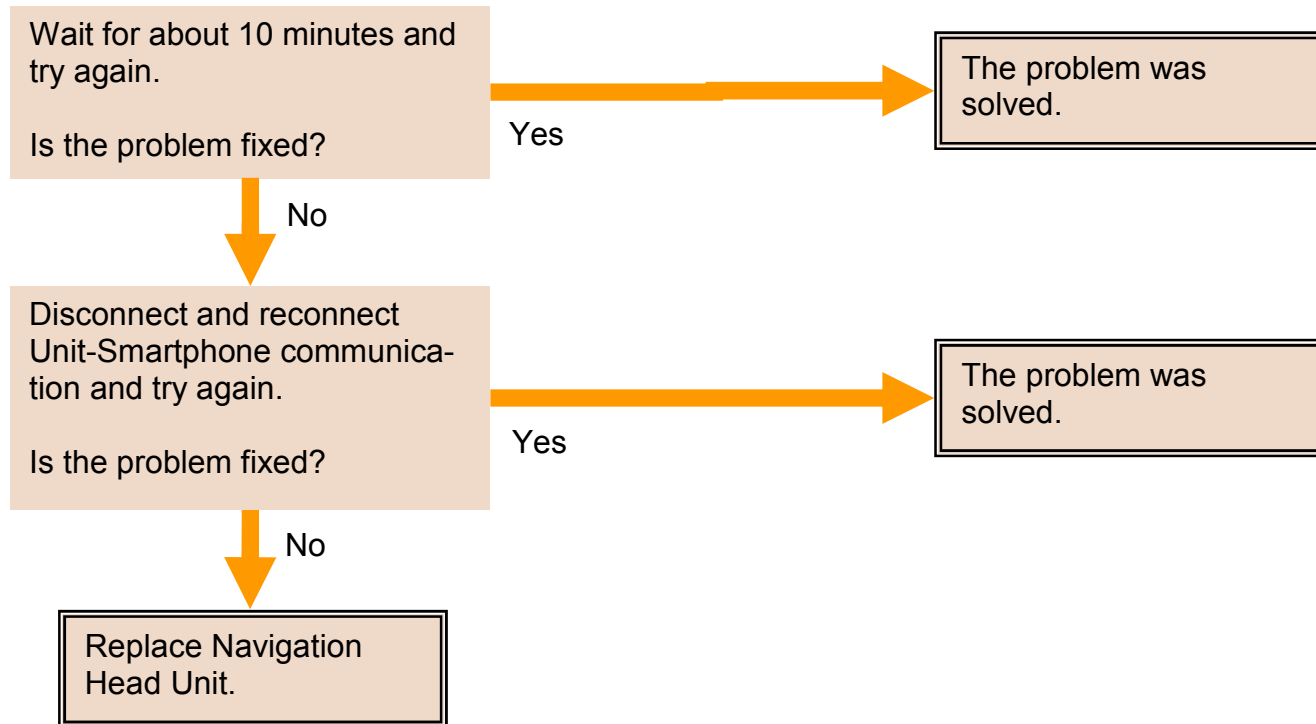

How to change "Aha Radio Setting":

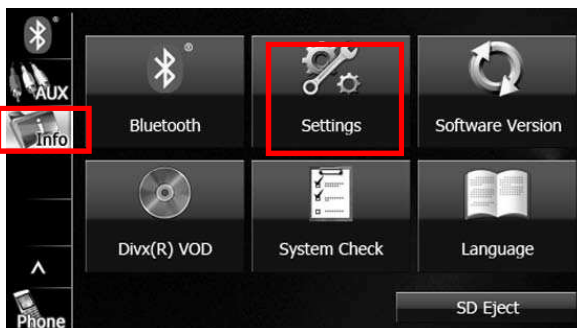

1. Press "INFO" and select "Settings"



2. Select "iOS" or "Bluetooth"

AHA RADIO - Caution Message (19)

Caution Message:

**External device has been connected.
Voice recognition mode off.**

Note:
Aha Radio is not available for
86271AJ67A and 86271AJ77A

Symptom:

Voice Recognition Mode has turned OFF by itself

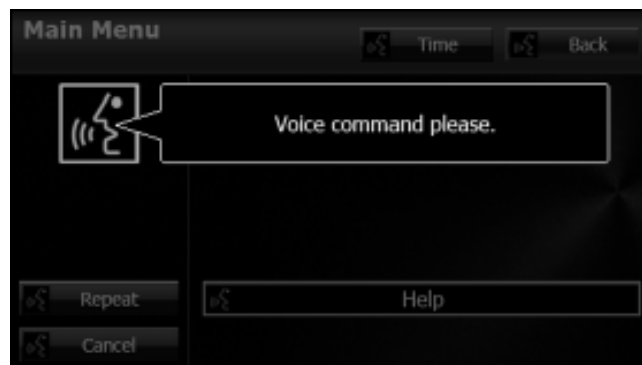
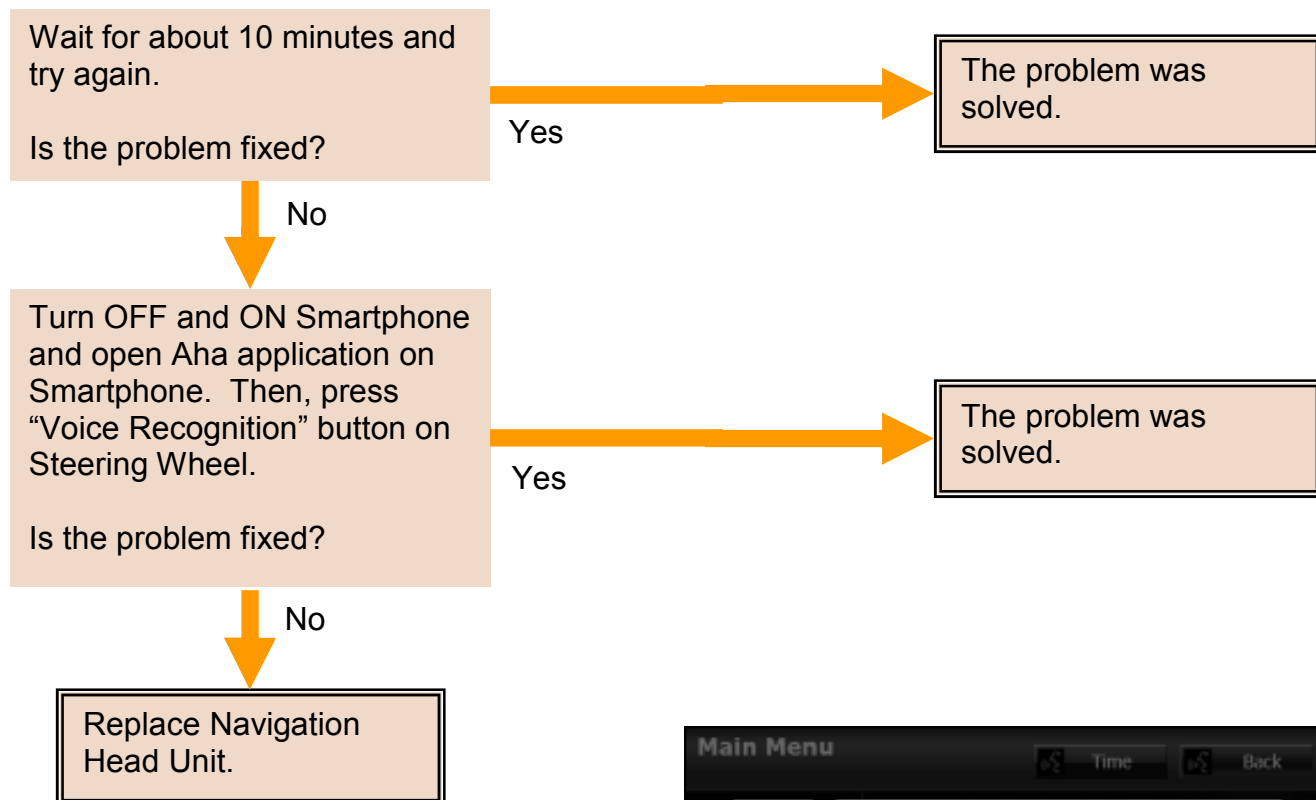

2. Troubleshooting

AHA RADIO - Caution Message (20)

Caution Message:

**Connection with Aha app is not completed.
Please try again later.**

*Note:
Aha Radio is not available for
86271AJ67A and 86271AJ77A*

Symptom:



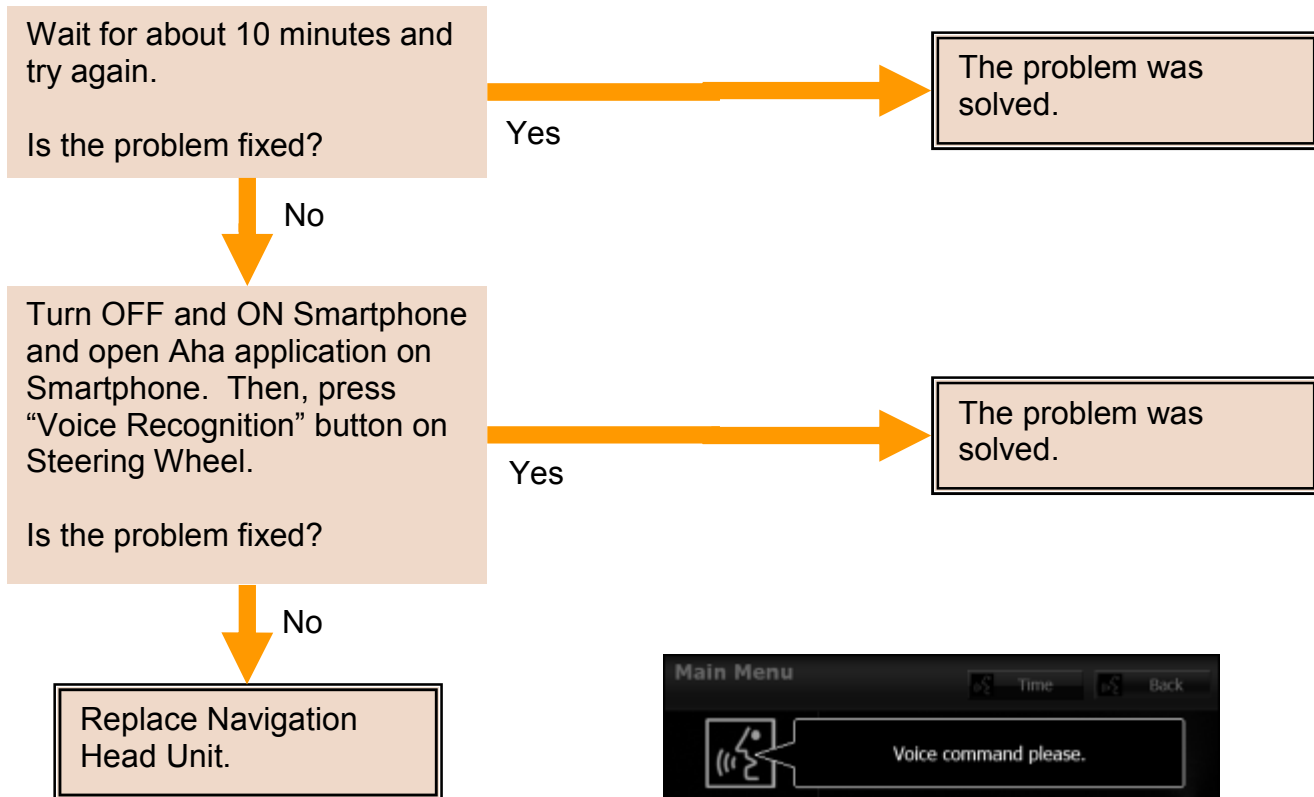

Voice Recognition Mode does not work for Aha Radio





MEMO

3. FAQ

Navigation

Q1	How can I eject the SD card ?
A1	<p>1 Press AUDIO.</p> <p>2 Touch Info.</p> <ul style="list-style-type: none">• If Info is not displayed, touch V. <p>3 Touch SD Eject (SD Eject).</p>  <p>4 After checking the caution screen, touch Yes (Yes).</p> <ul style="list-style-type: none">• This screen does not appear if the card is not the specified SD memory card.  <p>5 When "Please eject SD card." appears, remove the SD memory card.</p> <ul style="list-style-type: none">• Press in the SD memory card until you hear it "click", let go of the card, and then pull it straight out.  <p>Removing the SD memory card cover</p> <p>1 Place a screwdriver with its tip protected in the groove on the top of the cover. Using the screwdriver, pull the cover a little toward you.</p>  <p>2 Lift up the top of the cover and remove the cover.</p>

Q2	What if I eject the MAP SD card while using the Navigation system?
A2	You can corrupt the MAP data file and navigation system may stop working. Please do not eject the MAP SD card while navigating.

Q3	How do I know if my Navigation unit is receiving GPS signals?
A3	<p>1. Touch "Menu" on MAP screen</p>  <p>2. GPS signal is shown on top right corner of the display. Signal strength is indicated by the number of dot. More dots, stronger GPS reception.</p> 

Q4 How can I adjust the contrast and brightness of the screen?

A4

1. Press **DISP**
2. After completing the adjustment, touch 



<For the operations screen>



Q5 How can I change the language for Display and Voice Recognition?

A5

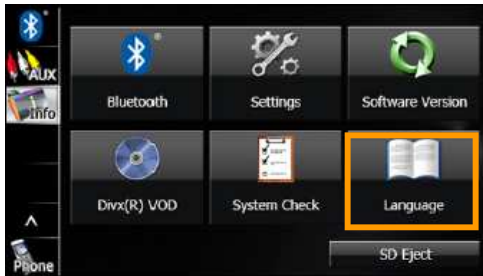

1. Press **AUDIO**
2. Touch "Info"
3. Touch "Language"
4. Select a language

Q6 My navigation voice guidance volume is too low. How can I adjust the volume?





A6

1. Touch  on MAP screen
2. Adjust the volume with the slider

3. FAQ

Navigation

Q7	Can I review my entire driving route in simulation?
A7	<p>Yes.</p> <ol style="list-style-type: none">1. Set your destination2. Touch “Menu” on MAP screen3. Touch “My Route”4. Touch “More”5. Scroll down the list and touch “Simulate Navigation”  
Q8	I live in the high elevation area, does the unit provide altitude information?
A8	<p>Yes. The altitude is measured using GPS signals and displayed at the bottom right corner of the display.</p> 
Q9	What is the “data field” on the MAP screen and can I customize the “data field”?
A9	<p>The data field provides you the information of current time, altitude of your location, distance to the destination, time left to the destination and estimated arrival time. The information in the data field can be customized by touching and holding the “data field” area.</p>  <p>You can select up to 3 data field from below:</p> <ul style="list-style-type: none">• Time• Altitude• Distance• Time Left• Arrival Time <p>Distance, Time Left and Arrival Time are available only when the destination is set.</p> <p>Altitude: The minimum of 4 acquired satellites is required to establish Altitude. With 3 or less acquired satellites, "--" may be displayed on the navigation screen.</p> <p>“data field” area</p>

Q10 What types of MAP views are available?

A10 Three types of MAP views are available (2D North Up, 2D Heading Up, and 3D)
 How to change the MAP view.
 1. Touch "Menu" on MAP screen
 2. Touch "More..."
 3. Touch "Settings"
 4. Scroll down and touch "MAP Settings"
 5. Touch "View Mode"

Q11 How can I set my home as a destination?

A11
 1. Touch "Menu" on MAP screen
 2. Touch "Destination"
 3. Touch "Find Address"
 4. Enter "State", "City", "Street" and "House Number" of home address and touch "Done"
 5. Touch "More"



6. Touch "Add to Favorites"

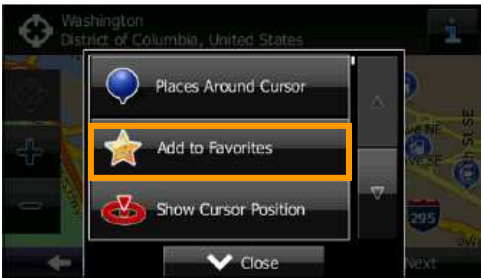

7. Enter "HOME" using keyboard and touch "Done"



Note:
 Your HOME is registered under "Favorites"
 Please confirm if your Home is in Favorites.
 1. Touch  on Map screen





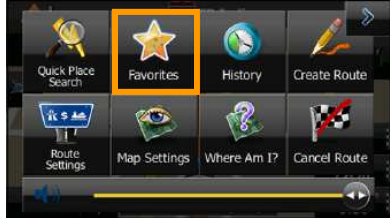

2. Touch "Favorites"



3. FAQ

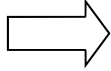



Navigation

Q12	I want to use the Navigation system to go back to home. How can I do?								
A12	<p>Please make sure your home has been added to the “Favorites.” If not, refer to Question 11.</p> <p>If your home is set to the “Favorites”, follow the procedure below.</p> <ol style="list-style-type: none">1. Press “MAP”2. Touch “Menu” on MAP screen3. Touch “Destination”4. Touch “Favorites”5. Touch “HOME”6. Touch “Next”7. Touch “Go”								
Q13	What is the Quick Menu?								
A13	<p>Frequently used buttons and functions during navigation operation are displayed on the Quick Menu and you can customize the buttons in the Quick Menu.</p> <p>How to open the Quick Menu.</p> <ol style="list-style-type: none">1. Touch  on MAP screen <div data-bbox="305 1171 781 1444"></div> <div data-bbox="813 1276 922 1346"></div> <div data-bbox="964 1136 1442 1444"><p>Quick Menu</p><table border="1"><tr><td>Quick Place Search</td><td>Favorites</td><td>History</td><td>Create Route</td></tr><tr><td>Route Settings</td><td>Map Settings</td><td>Where Am I?</td><td>Cancel Route</td></tr></table></div> <p>How to customize the Quick Menu</p> <ol style="list-style-type: none">1. Press “MAP”2. Touch “Menu” on MAP screen3. Touch “More...” 4. Touch “Settings”5. Touch “Customize Quick Menu”	Quick Place Search	Favorites	History	Create Route	Route Settings	Map Settings	Where Am I?	Cancel Route
Quick Place Search	Favorites	History	Create Route						
Route Settings	Map Settings	Where Am I?	Cancel Route						
Q14	Can I access the “Quick Menu” while driving?								
A14	Yes								

Q15	What is the “Route Planning Methods”?
A15	“Route Planning Methods” provide you options to search the route to the destinations.
Q16	What “Route Planning Methods” are available?
A16	<p>4 Route Planning Methods are available (Fast, Green, Short and Easy).</p> <ul style="list-style-type: none"> - Fast (Fast): Searches all roads for the quickest route following the speed limits of the roads. - Green (Green): Searches for the route that conserves the most energy, taking into account the merits of “Fast” and “Short”. - Short (Short): Searches for the shortest distance in all possible routes. - Easy (Easy): Searches for a route that is easiest to drive, with few right and left turns. Using this option, the program allows you to avoid combinations of smaller roads and to take the expressway.

3. FAQ

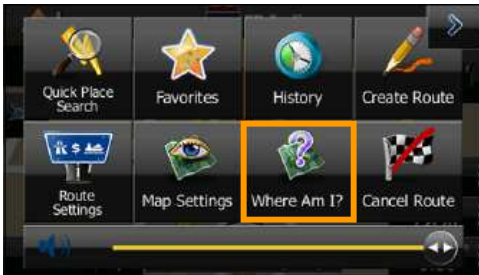

Navigation

Q17	How can I choose a “Route Planning Method” (Fast, Green, Short and Easy)?
A17	<ol style="list-style-type: none">1. Touch “Menu” on MAP screen2. Touch “More”3. Touch “Settings”4. Touch “Route Settings”5. Touch “Route Planning Method”6. Select one from “Fast” “Green” “Short” and “Easy”
Q18	How can I find my current location/position?
A18	<ol style="list-style-type: none">1. Touch  on MAP screen  <ol style="list-style-type: none">2. Touch “Where Am I?”  <p>Where Am I?</p> 

Q19 How can I locate emergency services (Hospital, Police etc) near me?

A19

1. Touch  on MAP screen
2. Touch "Where Am I?"
3. Touch "Help Nearby"
4. Select one of categories

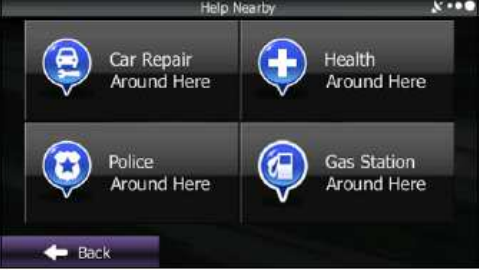

Q20 What kind of navigation methods are available to the destination?



A20

Address, Places (POI), Map, Favorites and History

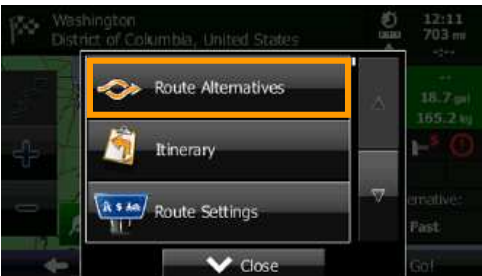

3. FAQ

Navigation

Q21	How can I change “Route Planning Method” while entering the destination?
A21	<p>1. Touch “More” before touching “Go!” 3. Select one from “Route Alternatives”</p> <p>2. Touch “Route Alternatives”</p>    <p>“Route Alternatives”</p>
Q22	How can I change my destination while driving?
A22	<p>While driving, the destination can be changed by using the Voice control function</p> <ol style="list-style-type: none">1. Press “Voice Control Button ’ on steering control2. Say “Navigation”3. Say “Find” <p>New destination can be set by Address, Places, Favorites or History and then continuously follow the voice control guidance.</p>

Q23

How can I find a “POI” by category?



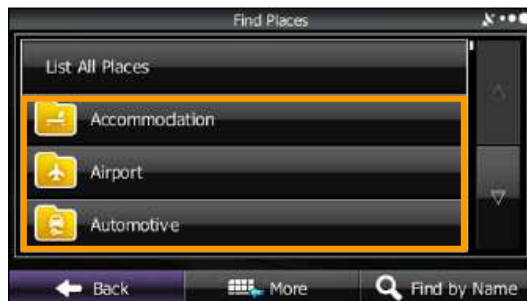

A23

- 1 If the Map screen is displayed, touch **Menu** (Menu) to return to the navigation menu.
- 2 On the navigation menu, touch **Destination**
- 3 Touch **Find Places** (Find Places).
- 4 Touch **Custom Search** (Custom Search).
- 5 Select the spot area you want to search for as follows.
 - Touch **Around Here** (Around Here) or **Around Last Known Position** (Around Last Known Position) to search around your current position, or the latest confirmed position.
 - Touch **In a City** (In a City) to search for city/town spots.
 - Touch **Around Destination** (Around Destination) to search for spots at the destination during route navigation.
 - Touch **Along Route** (Along Route) to search along the route being navigated, rather than around an optional point. This is useful when you want to search for a gas station or restaurant and so on along the route taking the smallest detour to get there.
- 6 Select one of Categories.

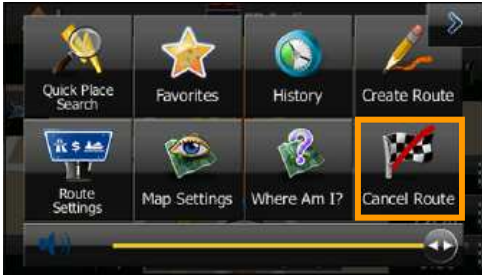

3. FAQ

Navigation

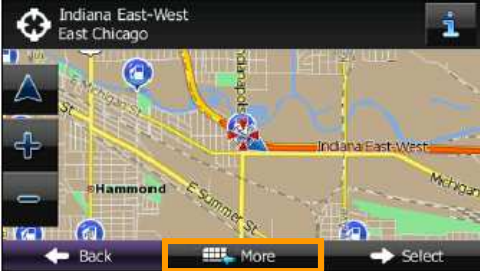
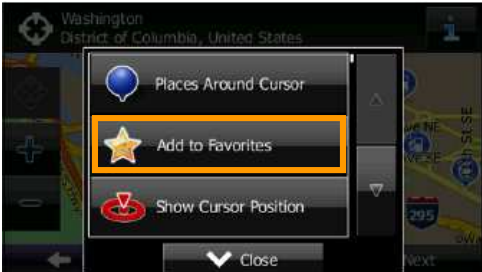
Q24	How many “POI” categories are available?
A24	18 categories are available (Accommodation, Airport, Automotive, Business, Café or Bar, Community, Favorites, Finance, Gas Station, Leisure, Marine, Medical, Parking, Restaurant, Shopping, Sports, Transport and Truck)
Q25	How can I cancel my destination?
A25	<p>1. Touch  on MAP screen</p>  <p>2. Touch “Cancel Route”</p> 
Q26	How do I delete the History of destination (previous destination)?
A26	<p>1. Touch “Menu” on MAP screen</p> <p>2. Touch “Destination”</p> <p>3. Touch “History”</p> <p>4. Touch “More” </p> <p>5. Touch “Delete All”</p>
Q27	How can I add a destination to “Favorites” ?
A27	<p>1. Set a destination</p> <p>2. Touch “More” </p>  <p>3. Touch “Add to Favorites”</p>  <p>4. Enter the name of Favorite with keyboard</p> <p>5. Touch “Done”</p>

Q28 How can I rename a “Favorite”?

A28

1. Touch  on MAP screen



2. Touch “Favorites”

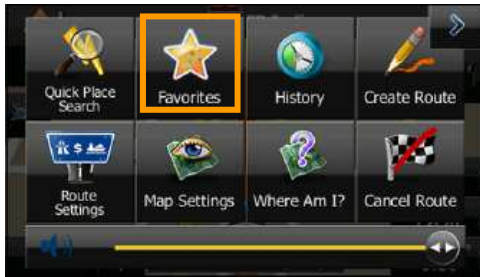

3. Select one you want to change the name

4. Touch 



5. Touch “More” 

6. Touch “Rename Favorite”

Q29 Can I set a destination by using Voice Command while driving?

A29

Yes

Q30 How can I access previously used destinations?

A30

1. Touch “Menu” on MAP screen
2. Touch “Destination”
3. Touch “History”

Q31 How can I see the entire trip route?

A31

1 Touch **Menu** (Menu) on the Map screen.





2 Touch **My Route** (My Route) on the navigation

3 Touch **Overview** (Overview). The entire route currently being navigated is displayed on the map along with detailed information and buttons.



3. FAQ

Navigation

Q32	What maps are stored in the MAP SD Card?
A32	US (50 states, District of Columbia & Puerto Rico), Canada (13 Provinces)
Q33	Does the route guidance consider traffic conditions?
A33	Yes. Real time traffic information is provided by XM Traffic with XM subscription.
Q34	How do I change the language for Voice Guidance?
A34	<ol style="list-style-type: none">1. Touch "Menu" on MAP Screen2. Touch "More..." 3. Touch "Settings"4. Touch "Sound and Warnings"5. Touch "Voice Language"6. Select one language
Q35	Can I use the Navigation functions while the MAP SD card is removed?
A35	No, navigation information is stored in the MAP SD card.
Q36	Why does the Altitude reading show "--"?
A36	<p>The function shows the altitude of the road currently being driven and measured by the GPS receiver. The minimum of 4 acquired satellites is required to establish Altitude. With 3 or less acquired satellites, "--" may be displayed on the navigation screen.</p>  <p>The screenshot shows a navigation map with a yellow route. The altitude reading at the bottom right is "--". The map includes street names like W Grand Ave, W Illinois St, W Kinzie St, N Franklin St, and N Orleans St. The interface also shows a 'Menu' button and a compass.</p>

Q37

How can we get detailed GPS information?

A37

GPS Info can be set on Quick Menu. Frequently used buttons and functions used during navigation can be selected and displayed on Quick Menu.

Set GPS Info on Quick Menu:



1. Touch "Menu"

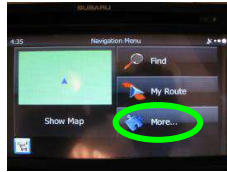

2. Touch "More"



3. Touch "Settings"

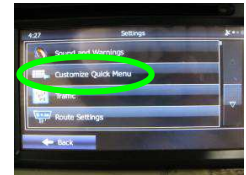

4. Touch "Customize Quick Menu"



5. Select and touch unnecessary item



6. Select "GPS Info"



7. Now "GPS Info" is added on Quick Menu

Open GPS Info:



1. Press "MAP" on the unit



2. Touch the Quick Menu icon



3. Touch "GPS Info"



GPS Information Screen

Number of satellites currently acquired (positioned)



Satellite conditions
Green = Good reception
Red = Poor reception

Satellite number

Note:
4 or more satellites are needed for 3D positioning.

3. FAQ

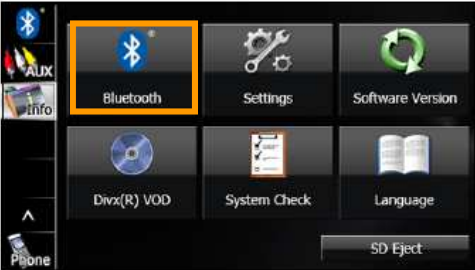
Bluetooth Hands-free

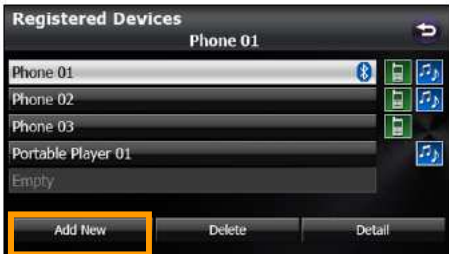
Q1	Which Bluetooth phones are compatible with the Navigation unit?
A1	A phone compatibility list is available at Subaru Website http://www.subaru.com/engineering/multimedia-electronics.html
Q2	What should I do first to use the Bluetooth hands-free function with the Navigation unit? How can I register my phone to the Navigation unit?
A2	<p>1. Check if your phone is compatible with Navigation unit from Subaru Website at http://www.subaru.com/engineering/multimedia-electronics.html</p> <p>2. Register your phone to the Navigation unit by following procedure below.</p> <ol style="list-style-type: none"> 1 Press AUDIO. 2 Touch Info. If Info is not displayed, touch ∨. 3 Touch Bluetooth.  4 Touch Registered Devices (Registered Devices)  5 Touch Add New (Add New).  6 Operate the cell phone to enter the passcode (passkey) of the unit. <ul style="list-style-type: none"> • The name of the unit is CAR MULTIMEDIA. • The initial setting for the passcode (passkey) is 0000. • Operate the cell phone while the Registered Devices screen is displayed. 7 When the registration is complete, "Connection Completed" appears. <ul style="list-style-type: none"> • The cell phone registration is complete. <p>NOTE</p> <ul style="list-style-type: none"> • If the registration fails, "Connection failed" appears on the screen. If this happens, perform the registration operation again. • For details of operations on the cell phone, see the cell phone's instruction manual. • When processing a Bluetooth connection, the Bluetooth Audio may skip.

Q3	How many cell phones can be registered to the Navigation unit?
A3	Up to 5 phones

Q4	When multiple phones are registered to the Navigation unit, which phone will be connected first when the Navigation unit turns ON ?
----	---





A4	<p>The order of connection precedence is 1 to 5.</p>  <p>The system tries to connect to the first registered phone. If the first registered phone is not present or phone Bluetooth is disabled, the second phone will be connected. If the second phone is not present or it's Bluetooth is disabled, the third phone will be connected.</p>
----	---

Q5	What Bluetooth Specifications and Profiles are supported by the Navigation unit?
----	--

A5	<ul style="list-style-type: none"> • Supported Bluetooth Specifications <ul style="list-style-type: none"> - Bluetooth Specification Ver. 1.1 or higher (Ver. 2.0 + EDR or higher is recommended) • Supported Profiles <ul style="list-style-type: none"> - HFP (Hands Free Profile) Ver. 1.0 - OPP (Object Push Profile) Ver. 1.1 - DUN (Dial-up Networking Profile) Ver. 1.1 - SYNC (Synchronization Profile) - PBAP (Phone Book Access Profile) - MAP (Message Access Profile)
----	--

3. FAQ

Bluetooth Hands-free

Q6	How can I find out the signal strength level of my Bluetooth phone with the unit?
A6	<div data-bbox="280 310 873 709"></div> <div data-bbox="305 726 699 919"><ul style="list-style-type: none">(1) Bluetooth signal icon(2) Battery level indicator(3) Roaming area icon(4) Reception indicator</div> <div data-bbox="889 380 1544 867"><p>Bluetooth signal quality icon</p><p>Displays the Bluetooth connection status of a cell phone.</p><ul style="list-style-type: none">When a Bluetooth connection is established,  and reception level are displayed.<p>NOTE</p><ul style="list-style-type: none">A Bluetooth communication antenna is embedded in the car display. If a Bluetooth-enabled cell phone is used in the following locations or conditions, the Bluetooth connection status display may turn gray or Bluetooth connection may not be possible.<ul style="list-style-type: none">When the cell phone is hidden from the display (when the cell phone is behind or under a seat or in the glove box or console box).When the cell phone is touching or covered by a metal object.To use a Bluetooth-enabled cell phone, move the phone to a location where the blue display appears.When setting the cell phone to power saving mode, the Bluetooth connection may be automatically disconnected. If this happens, switch off the power saving mode of the cell phone.</div>
Q7	How can I open the hands-free call screen?
A7	<ol style="list-style-type: none">1 Press AUDIO.2 Touch  (Phone).<ul style="list-style-type: none">The handsfree screen appears.<Handsfree screen> <div data-bbox="305 1245 764 1503"></div>

Q8

When multiple phones are registered to the Navigation unit, how do I know which phone has been connected when the Navigation unit turns ON?

A8

1 On the handsfree screen, touch **Settings** (Settings).



2 Touch **Connection** (Connection).



3 The Bluetooth mark is displayed for cell phones with an active Bluetooth connection.



Q9

How can I select my phone if another phone has been connected when the Navigation unit turns ON?

A9

1 On the handsfree screen, touch **Settings** (Settings).



2 Touch **Connection** (Connection).



3 Select the cell phone that you want to connect.

- The Bluetooth mark is displayed for cell phones with an active Bluetooth connection.







4 Touch **Connect** (Connect).

5 When the connection is complete, "Connection Completed" appears.

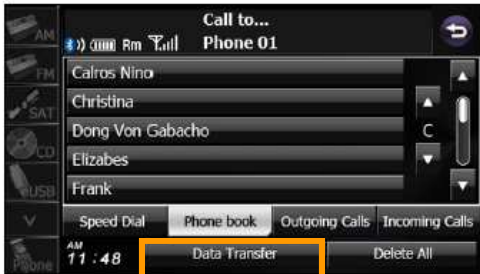
3. FAQ

Bluetooth Hands-free

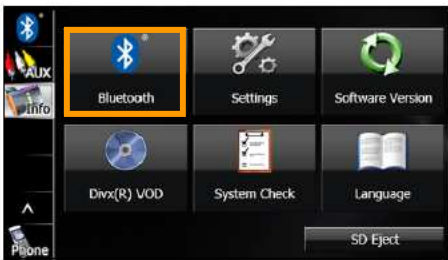
Q10	What methods are available to make a call?
A10	<p>You can make a call</p> <ul style="list-style-type: none">• By entering a phone number• From call history (Outgoing Calls & Incoming Calls)• From Phonebook• From Speed Dial
Q11	How many “Outgoing and Incoming Call Histories” are stored to Navigation unit?
A11	<p>The incoming and outgoing call histories can each store 10 calls for each registered cell phone. In the incoming call history, 5 missed calls and 5 other calls can be stored. When 10 calls are stored (5 missed incoming calls and 5 other calls), the oldest call is deleted from the history at the next call.</p>
Q12	How can I transfer my phone book to the Navigation unit?
A12	<p>After the registration is completed, “Do you want to transfer the phone book from your mobile?” should appear and then, touch “Yes”.</p> <p>or</p> <ol style="list-style-type: none">1 On the handsfree screen, touch Contacts (Contacts).  <ol style="list-style-type: none">2 Touch Phone book (Phone book).  <ol style="list-style-type: none">3 Touch Data Transfer (Data Transfer). <ol style="list-style-type: none">4 When the phone book transfer screen appears, operate the cell phone to transfer the phone book data.<ul style="list-style-type: none">• Perform the transfer operation on the cell phone while the phone book transfer screen is displayed.• When the transfer is in progress, wait until the transfer completed message appears.• When the transfer is complete, the transfer completed message appears.  <p><Phone book transfer screen></p>

Q13	How many phone contacts can be transferred to the Navigation unit?
A13	Up to 1000 persons can be transferred for each registered phone.
Q14	During phonebook transfer what happens if more than 5 numbers are registered to one person in the phone book of the cell phone?
A14	The top 4 numbers will be transferred to the unit in the order of “Mobile”, “Home”, “Work”, and “Other.”
Q15	How can I delete my phone that was registered to the Navigation unit?
A15	<p>1 Press AUDIO.</p> <p>2 Touch Info.</p> <ul style="list-style-type: none"> • If Info is not displayed, touch V. <p>3 Touch Bluetooth.</p>  <p>4 Touch Registered Devices (Registered Devices)</p>  <p>5 Select the cell phone that you want to delete.</p>  <p>6 Touch Delete (Delete).</p> <ul style="list-style-type: none"> • “Are you sure to delete the entry?” appears on the screen. Touch Yes (Yes) or No (No). • After touching “Yes”, when the deletion is complete, “Completed” appears. • The cell phone deletion is complete. <p>NOTE When a cell phone registration is deleted, the outgoing call history, incoming call history and phone book data that are saved in the unit are also deleted.</p>

3. FAQ

Bluetooth Hands-free

Q16 How can I delete all phone contacts from the Navigation unit?

A16 **1** On the handsfree screen, touch **Contacts** (Contacts).



2 Touch **Phone book** (Phone book).



3 Touch "Delete All" 

Q17 How can I delete a single phone contact from the Navigation unit?

A17 **1** On the handsfree screen, touch **Contacts** (Contacts).



2 Touch **Phone book** (Phone book).

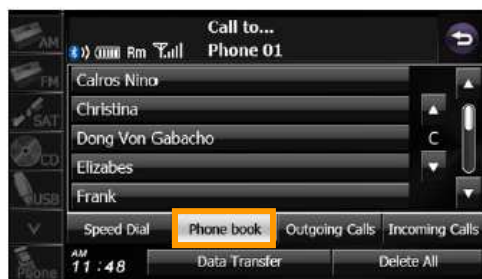

3 Select a person name to delete

4 Touch "Delete"



Q18 What methods are available to place a call while driving?

A18 You can make a call

- From call history (Outgoing calls, Incoming calls)
- From Speed Dial
- Voice control

Q19 How can I receive a call?

A19 You can receive incoming calls when any source mode is selected. When a call arrives, the Incoming call screen appears automatically.

When you hear the ringtone, touch .

- You are connected and able to talk.
- Touch  to hang up and refuse the incoming call.



<Incoming call screen>



Q20 How can I adjust the volume level of the outgoing calls?





A20 During a call, Talking screen is displayed

- 1 On the Talking screen, touch **Mic Level** (Mic Level).
- 2 Adjust by touching **+** or **-**.
 - **+**: Call volume up
 - **-**: Call volume down
 - Touch **+** for 1 second or more to raise the volume continuously.
 - Touch **-** for 1 second or more to lower the volume continuously.

3. FAQ

Bluetooth Hands-free

Q21	How can I transfer a call from Hands-free to my cell phone?
A21	<p>When using a Bluetooth cell phone, you can transfer calls between the unit and the cell phone.</p> <p>The call is switched from a handsfree call to a cell phone call, or from a cell phone call to a handsfree call.</p> <p>Touch Transfer (Transfer).</p> <ul style="list-style-type: none">• Touch Transfer (Transfer) again to switch to a handsfree call. 
Q22	Can I switch a call between private and hands-free mode while driving ?
A22	No
Q23	Is a “call waiting” function available?
A23	<p>Yes.</p> <p>If a call arrives from another phone while you are already talking, you can put the current call on temporary hold by using the Talking screen and receive the new incoming call.</p> <p>When you hear the ringtone, touch  on the Talking screen.</p> <ul style="list-style-type: none">• You can put the current call on hold and connect to the new call.• To end call waiting, touch . When call waiting ends, the phone connects to the call that was put on hold and you can continue the previous call.• During call waiting, touch  again to switch between the callers. 

NOTE

If a call waiting contract has not been setup for the cell phone itself, you cannot use the call waiting function.

Q24	Will the Hands-free call be automatically transferred to the cell phone when the vehicle is turned off?
A24	Yes

Q25	Can a phone call be transferred to the hands-free call when the vehicle is turned on?
A25	Yes

Q26 How can I set my Navigation unit to answer a hands-free call automatically?

A26

- 1 On the handsfree screen, touch **Settings** (Settings).



- 2 On the phone Settings screen, you can perform the following settings by touching the setting buttons for each item.
<Phone Settings screen (page 1)>





Auto Answer setting
Start the call automatically 5 seconds after the arrival of an incoming call.

Touch **On** (On) or **Off** (Off).

3. FAQ

Bluetooth Hands-free

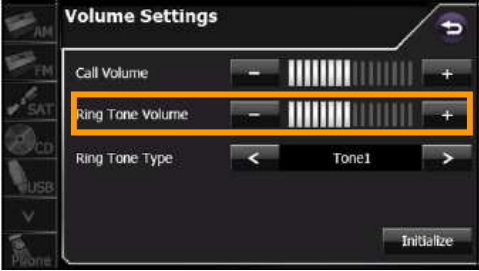
Q27	How can I adjust the Ring Tone volume ?
A27	<p>1 On the handsfree screen, touch Settings (Settings).</p>  <p>2 Touch “Volume Settings”</p>   <p>Adjust by touching + or -.</p> <ul style="list-style-type: none">+ Ringtone volume up- Ringtone volume down
Q28	How can I adjust the Ring Tone volume while receiving a call?
A28	The Ring Tone volume can be adjusted with Steering Wheel Switches (+) / (-).
Q29	What Bluetooth profiles are required in my phone for Phone book transfer?
A29	PBAP (Phone Book Access Profile) or OPP (Object Push Profile).

Q30 How can I register “Speed Dial” numbers?

A30

1 On the phone book screen, touch the data item that you want to register.

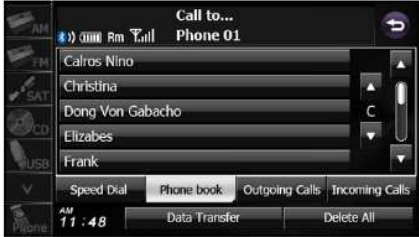

- If 2 or more telephone numbers are registered for the selected person (name or telephone number), the telephone number selection screen appears. Touch the telephone number that you want to register.

2 Touch **Add to Speed Dial** (Add to Speed Dial).



3 Touch the number in the Speed Dial list where you want to register the telephone number.

- “Speed Dial Saved.” appears and the Speed Dial registration is complete.

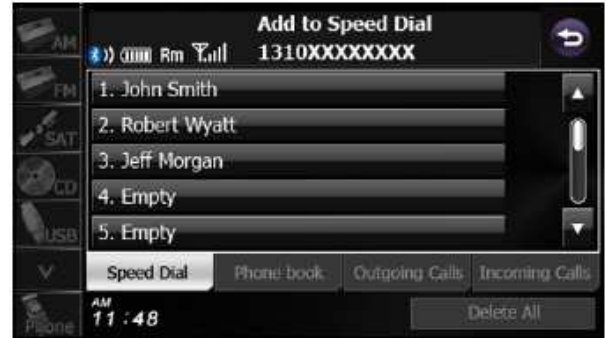

Q31 How many “Speed Dial” numbers can be registered?

A31

Up to 10

Q32 How can I change the passcode (passkey)?

A32

You can change the passcode (passkey) for cell phone registration to any number with 4 to 8 digits.

- 1 Press **AUDIO**.
- 2 Touch **Info**.
 - If **Info** is not displayed, touch **V**.
- 3 Touch **Bluetooth**.

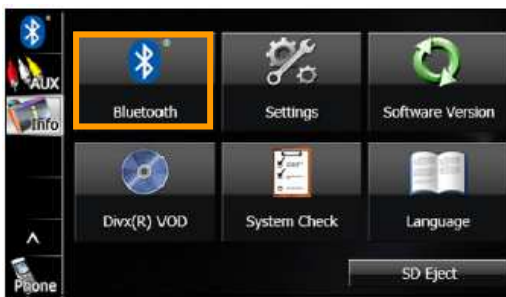

4 Touch **Passcode Settings** (Passcode Settings).



5 Enter a number by touching 1 digit at a time, and enter a number with 4 to 8 digits.



- If you make a mistake, touch **X** to delete 1 digit at a time. Touch for 1 second or more to delete the digits continuously.



6 Touch **Done** (Done).

3. FAQ

Bluetooth Hands-free

Q33	What Bluetooth profiles are required to use the Message function?
A33	<ul style="list-style-type: none">• HFP (Hands-free Profile) Ver.1.0 or later (Conformed Ver.1.5)• MAP (Message Access Profile)
Q34	What types of messages can be received on the Navigation unit?
A34	<ul style="list-style-type: none">• SMS (Short Message Service)• MMS (Multimedia Message Service)• E-mail
Q35	How can I see messages received?
A35	<p>1 On the handsfree screen, touch Messages (Messages).</p> <ul style="list-style-type: none">• The Messages screen appears.  <p><Messages screen></p>  <p>Icon for unread data Account list</p>
Q36	How can I delete my messages?
A36	You cannot delete messages using the unit. When 50 messages are stored, the oldest message will be deleted from the account list.

Q37

How can I check my messages?

A37

1 On the Messages screen, touch the message that you want to check.



<MMS and e-mail details screen>



<SMS details screen>



Attached file icon

- Advance to the next message.
- Return to the previous message.
- **Play** (Play): Perform audio playback of the message.
- **Reply** (Reply): Display the message reply screen.
- If there is telephone number data in the address, you can touch to call the number.
- Return to the Messages screen.

Q38

Can I open attached file on the message?

A38

No. When a file is attached with the message, the icon is displayed, but the contents of the attached files cannot be opened. Attachment may be viewed on your cell phone.



Attached file icon

3. FAQ

Bluetooth Hands-free



Q39	How can I reply to a message?
A39	<p>1 On the Messages screen, touch the message to which you want to reply.</p>  <p>2 Touch Reply (Reply).</p>  <p>3 Touch the message that you want to use from the Reply Messages list.</p>  <ul style="list-style-type: none">• Touch ▲ or ▼ to scroll the pages of the Reply Messages list.• Edit (Edit): Edit a registered reply message.• Free Message (Free Message): Create any message and use it as the reply.• ↶: Return to the message details screen. <p>4 Touch Send (Send).</p> <ul style="list-style-type: none">• The message is sent.
Q40	How many default “Reply Messages” are available?
A40	18 default “Reply Messages” are available
Q41	Can I reply to the message using one of default “Reply Messages” while driving?
A41	Yes, but you need to reply before closing the message. Once it’s closed, all messages cannot be accessed while driving

Q42 How can I edit or change the “Reply Messages”?

A42

- 1 On the Reply Messages screen, touch the message that you want to change.
- 2 Touch **Edit** (Edit).
- 3 Touch the keyboard and enter any message.
- 4 Touch **Done** (Done).
 - The message is registered.

You can enter up to 160 single-byte characters in a replay message





Q43 How can I create my own reply message (free message)?

A43

- 1 On the Reply Messages screen, touch **Free Message** (Free Message).
- 2 Enter a message.
- 3 Touch **Send** (Send).
 - The message is sent.

You can enter up to 160 single-byte characters in a replay message

Q44 How can I have my Navigation unit read the body of the message?

A44

1. Open a message
2. Touch “Play”

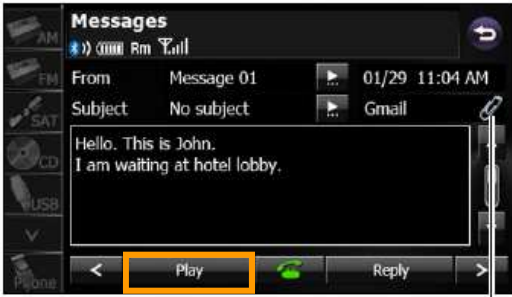

Attached file icon

3. FAQ

Bluetooth Hands-free

Q45 How can I adjust the volume level of message read by the Navigation unit?

A45 **1** On the Messages screen, touch **Settings** (Settings).



2 Touch “Volume Settings”

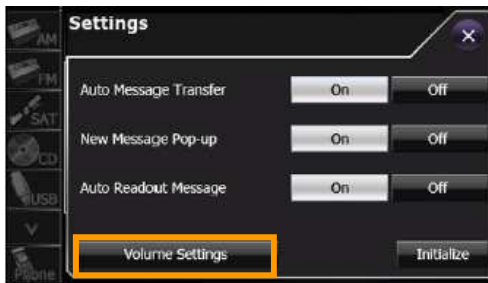

3 Adjust “Message Readout Volume”

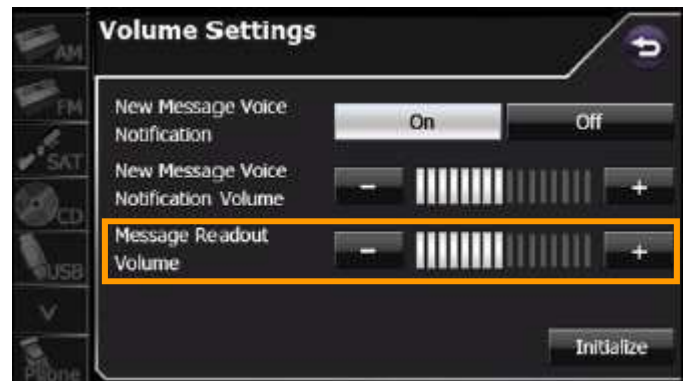

Q46 Can I set or configure the “Phone Settings” for each registered phone?

A46 Yes.

<Phone Settings screen (page 1)>



<Phone Settings screen (page 2)>



Item	Function
Handsfree	Set the handsfree function to on or off.
Bluetooth	Set the Bluetooth function to on or off.
Auto Answer	Set automatic call acceptance.
Auto Connect	Set automatic connection between a registered cell phone and the unit.
Auto Phonebook Transfer	Automatically transfer the phone book to the unit when a cell phone is registered.

Q47 How many “Ring Tones” types are available?

A47 3 different Ring Tones are available

1 On the handsfree screen, touch **Settings** (Settings).



2 On the phone Settings screen, you can perform the following settings by touching the setting buttons for each item.

<Phone Settings screen (page 1)>



3 Touch “Volume Settings”

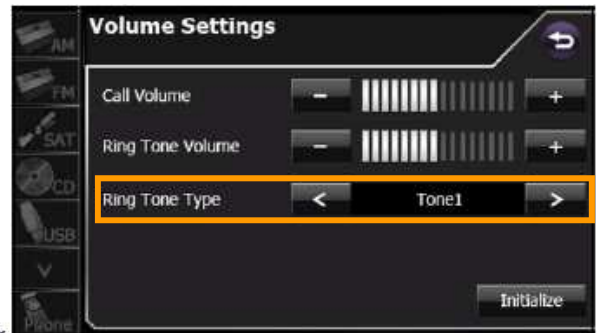

Touch **<** or **>**.

- Tone 1 ↔ Tone 2 ↔ Tone 3 ↔ Tone 1 ↔ ...

Q48 Can I reply to the received TEXT message by Speech (speech-to-text)?

A48 No. The unit does not have speech-to-text capability.

3. FAQ

Audio / Visual

Q1 How can I scroll through audio sources?

A1 1 Press **AUDIO**.

2 Touch **▼** or **▲** to scroll the screens.

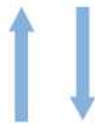

3 Select the audio mode that you want to use.

Q2 How can I adjust the Sound Quality?

A2 1 Touch **Sound** (Sound) on any of the audio operations screens.



2 Touch "Adjust" in EQ Settings.

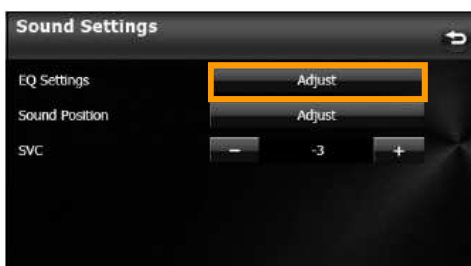

3 Touch the sound band you want to adjust.



Touch **▲** or **▼**.

- When you touch and hold, the value changes continuously but stops at the center value. Touch **▲** or **▼** again to restart.
- You can also adjust to the desired level by touching the screen.
- The maximum adjustment is +10 and the minimum adjustment is -10.
- To reset the sound quality, touch **Flat** (Flat).
- After completing the adjustment, touch **↶** to save the adjusted settings and return to the previous screen.

Q3 How can I save the Sound Quality Settings?

A3

- 1 Adjust the sound quality.
- 2 Touch any button from **EQ1** to **EQ5** for 2 seconds or more.
 - Values cannot be saved for **Flat** (Flat).

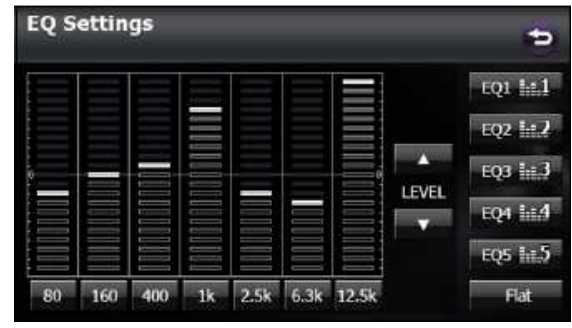

Q4 How many “EQ Settings” presets are available?

A4 6 (EQ1, EQ2, EQ3, EQ4, EQ5 and Flat)

Q5 How can I reset or initialize all EQ Settings (EQ1, EQ2, EQ3, EQ4 and EQ5)?

A5 Touch “Flat” for more than 2 seconds.

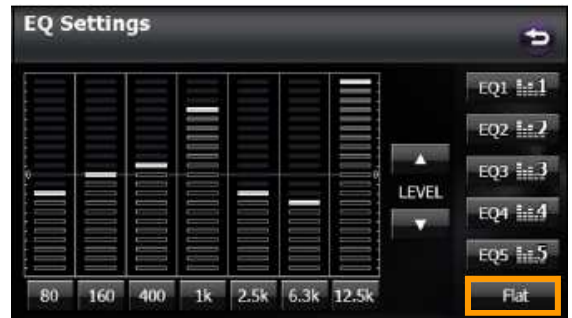

3. FAQ

Audio / Visual

Q6 How can I adjust the audio balance?

A6 **1** Touch **Sound** (Sound) on any of the audio operations screens.



2 Touch “Adjust” on Sound Position

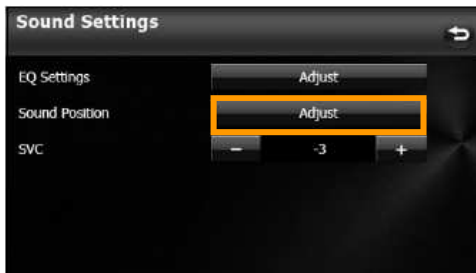

3 Touch the balance point you want to use

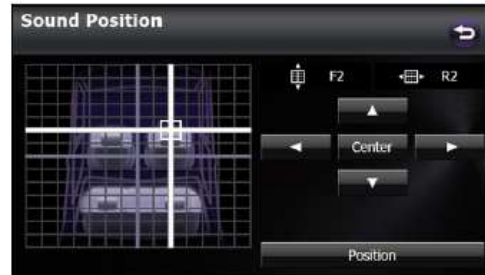

- To fine adjust, touch any of the balance adjusting buttons **▲**, **▼**, **◀** or **▶** to change the value by 1 step. When you touch and hold one of the balance adjusting buttons **▲**, **▼**, **◀** or **▶**, the value changes continuously but stops at the center value. To continue to change the balance, touch one of the balance adjusting buttons again.
- You can also adjust to the desired balance by touching the screen.
- Touch **Center** (Center) to cancel the Fader/Balance setting and return to the center value.
- After completing the adjustment, touch **↶** to save the adjusted settings and return to the Sound Settings screen.

Q7

How can I set the volume level for each audio source?

A7

1 Touch **Sound** (Sound) on any of the audio operations screens.



2 Touch **-** or **+** in SVC.









You can set a volume difference for each audio mode. The differences between the volume of the FM mode in the initial setting (initial value: 19), which is used as reference, and the volume levels set for each audio mode are saved.

After completing the adjustment, touch **↶** to save the adjusted settings and return to the previous screen.

3. FAQ

Audio / Visual

Q9	What is HD Radio?
A9	<p>HD Radio, which original stood for “Hybrid Digital”, is the trademark for iBiquity’s in-band on-channel (IBOC) digital radio technology used by AM and FM radio stations to transmit audio and data via digital signal in conjunction with their analog signals.</p> <p>Digital Sound </p> <p><i>Note: HD Radio service available in USA only (as of May 2013)</i></p> <p>Digital, CD-quality sound. HD Radio Technology enables local radio stations to broadcast a clean digital signal. AM sounds like today’s FM and FM sounds like a CD.</p>
Q10	Which radio station transmits radio program in HD mode?
A10	Check the information from the HD Radio website at http://www.hdradio.com/
Q11	How can I listen to HD Radio?
A11	<ol style="list-style-type: none">1. Find AM or FM station that broadcasts HD Radio from http://www.hdradio.com/2. Tune to the station <div data-bbox="316 1087 841 1386"></div> <p>Manual selection</p> <p>Touch  or .</p> <ul style="list-style-type: none">• : Move up 1 step.• : Move down 1 step. <p>Auto tuning</p> <p>Touch  or  for 1 second or more.</p> <ul style="list-style-type: none">• The tuner moves automatically to the station closest to the frequency currently displayed on the screen and stops. To cancel auto tuning while it is operating, touch the button again. <ol style="list-style-type: none">3. Touch “HD Radio” <div data-bbox="305 1648 831 1948"></div> <p>Indicator</p> <ul style="list-style-type: none">• ON (indicator lit): Audio is output according to the HD Radio setting and reception quality.• OFF (indicator off): Audio is output in analog regardless of the HD Radio setting or reception quality.• Touch HD Radio (HD Radio) to switch between ON and OFF.

Q12 How can I tell if the HD radio is broadcasting in “digital” mode?

A12 Once the digital signal is received, “Digital” is displayed



The screenshot shows a car radio interface with various buttons and displays. At the top right, there is a section labeled 'ST' with 'Digital' and 'ALL' below it. An orange arrow points to this section. The main display shows 'FM1 105.1MHz Station 03' and a list of six preset stations. The 'HD Radio' button is highlighted at the bottom.

Q13 How can I manually store radio stations as presets?

A13

- 1 Select the station that you want to save using manual tuning or auto tuning.
- 2 Touch the preset button that you want to use for 2 seconds or more.
 - The selected station is saved and displayed on the preset button.



The screenshot shows the same car radio interface as in Q12. The '3. Station 03' preset button is highlighted with an orange border, indicating it has been selected.

Q14 How can I store radio stations automatically into the preset buttons?

A14

- 1 Touch **Settings** (Settings).
- 2 Touch **Auto.P** (Auto.P) for 2 seconds or more.



The first screenshot shows the 'Settings' button highlighted in the bottom right corner of the main interface. The second screenshot shows the 'Settings' menu with 'Auto.P' highlighted in a yellow box at the bottom.

3. FAQ

Audio / Visual

Q15	How many AM/FM radio stations can be stored as presets?
A15	6 stations each for FM1, 2 and 3 and 6 stations for AM (Total: 24 stations)
Q16	How does "Tag" work ?
A16	<p>iTunes® Tagging</p> <p>iTunes® Tagging provides you the opportunity to discover a wide range of content and the means to "tag" that content for later review and purchase from the iTunes Store. Also refer to the Apple Automotive specifications for implementing iTunes® Tagging.</p> <p>If tag information exists for the track being broadcast, you can acquire the track's tag information.</p> <p>Touch Tag (Tag).</p> <ul style="list-style-type: none">• If an iPod is connected, the tag information is transferred to the iPod.• If an iPod is not connected, maximum 50 Tags will be stored in the HD Radio tuner. It is transferred to iPod at the time of iPod connection on the next time and is deleted from Tuner. 

Q17

What is “Sub Ch” ?

A17

In FM radio mode only, you can receive a sub channel broadcast if one exists for the currently broadcasting station.

Touch **Sub Ch** (Sub Ch).

- The sub channel changes each time you touch the screen.
- The current channel and the number of sub-channel reception is displayed at the upper right of the screen.

The current channel



The number of sub-channel reception





NOTE

HD2/HD3

FM stations can provide additional digital-only audio programming on HD2/HD3 Channels.

3. FAQ

Audio / Visual

Q18	Can I receive SAT (XM) for free?
A18	No. SAT (XM) radio is a paid subscription.
Q19	I cannot get some of the XM channels. Why?
A19	It may be an invalid channel or a non-subscribed channel.
Q20	How can I select a SAT channel?
A20	There are 4 ways to select a SAT channel (Preset, Channel, Direct and Category) <div style="display: flex; justify-content: space-around;"><div style="text-align: center;"><p>Preset</p><ol style="list-style-type: none">1. Touch "Preset"2. Touch a preset button</div><div style="text-align: center;"><p>Channel</p><ol style="list-style-type: none">1. Touch "Channel"2. Touch a channel</div></div> <div style="display: flex; justify-content: space-around;"><div style="text-align: center;"><p>Direct</p><ol style="list-style-type: none">1. Touch "Direct"2. Enter a channel number3. Touch "Done"</div><div style="text-align: center;"><p>Category</p><ol style="list-style-type: none">1. Touch "Category"2. Touch a category</div></div>

Q21 How can I store SAT radio channels?

A21

- 1** Select the channel that you want to save.
- 2** Touch **Preset** (Preset).
- 3** Touch **Preset** (Preset).
- 4** Touch the preset button that you want to use for 2 seconds or more.
 - The selected channel is saved and displayed on the preset button.
 - To manually set additional channels for the remaining preset channels, repeat this procedure for each channel.











Q22 How many SAT channels can be stored into the preset memory buttons?

A22 Save up 6 stations each for XM1, XM2 and XM3. (Total of 18 stations)

3. FAQ

Audio / Visual

Q23	How can I find the XM radio ID number?
A23	<p>1 Touch Preset (Preset).</p>  <p>2 Touch Direct (Direct).</p>  <p>3 Touch "0".</p> <ul style="list-style-type: none"> If you make a mistake, touch  to delete 1 digit at a time. Touch for 1 second or more to delete the digits continuously.  <p>4 Touch Done (Done).</p> <p>5 Touch .</p> <ul style="list-style-type: none"> An 8-digit numerical code appears. 
Q24	What types of CDs are supported?
A24	<p>An audio disc bearing one of the marks below can be played.</p> 
Q25	I cannot see TEXT information while playing my CD. Why?
A25	<p>The CD-TEXT function can be used only for commercially available CDs that support CD TEXT.</p> 

Q26	Does the system play MP3/WMA files on CD-R/CD-RW?
A26	Yes.

Q27	What is the recommended bit rate and sampling frequency of MP3/WMA files on CD-R/CD-RW?
A27	<ul style="list-style-type: none"> • Bit rate: 128kbps • Sampling frequency: 44.1KHz

Q28	How do I know if my USB memory is connected to the USB port correctly?
A28	Once the USB memory is connected to the USB port and recognized by the system, the USB icon will be highlighted.



Q29	What audio formats are supported by the system for the USB audio playback?
A29	MP3/ WMA

Q30	Which USB flash memory is supported (specification requirement)?
A30	<ul style="list-style-type: none"> • Supported file formats: FAT 32 • Supported audio formats: MP3/WMA/WAV • Maximum current: 1.0 A • Supported capacities: 16 MB to 8 GB • Compatibility: USB1.0/1.1/2.0 (maximum transfer speed is same as USB 2.0) • Mass memory support: Supports USB mass storage class. • Does not support USB hubs or multi card readers.

3. FAQ

Audio / Visual

Q31	How can I listen to the music stored in the USB flash memory?
A31	<ol style="list-style-type: none">1 Connect a USB memory that contains music files to the USB connector.2 Press AUDIO.3 Touch USB (USB).<ul style="list-style-type: none">• The playback starts.4 Select a Folder<ul style="list-style-type: none">Touch < or >.<ul style="list-style-type: none">• <: Return to the previous folder and play the first file in the folder.• >: Advance to the next folder and play the first file in the folder.5 Touch a music file to play 
Q32	Can I watch video stored in the USB memory while driving?
A32	<p>No. In order to watch video contents, the vehicle must be stopped and the parking brake applied.</p> <p>If the source is switched to USB video while the vehicle is in motion, only audio can be heard.</p>

Q33 How can I watch a USB video contents ?

- A33
- 1 Connect a USB memory that contains video files to the USB connector.
 - 2 Press **AUDIO**.
 - 3 Touch **USB** (USB).
- The playback starts.
 - Touch the video to show it in a full-screen display. To display the operation buttons (touch buttons) again, touch the full-screen display.



Note:
You can watch a USB video only if you have stopped your vehicle and applied the parking brake to ensure safety and turned the ignition switch to ON or ACC ON.

Q34 How to view video in full screen size?

A34 Touch the area where the video is shown to view in full screen mode.



3. FAQ

Audio / Visual

Q35 How can I change the subtitle language of the USB video playback?

A35 If the video file stores multiple subtitle languages, you can change the subtitle language that is used.

1 Touch **Settings** (Settings).



2 Touch **Subtitle** (Subtitle).



3 Touch **Change Subtitle** (Change Subtitle).

- Each time you touch **Change Subtitle** (Change Subtitle), the subtitle number changes, and the subtitle languages recorded on the video file change in sequence.
- Touch **Subtitle Off** (Subtitle Off) to play without displaying subtitles on the screen.



Q36 How can I change the audio language of the USB video playback?

A36 If the video file stores multiple audio languages, you can change the audio language that is used.

1 Touch **Settings** (Settings).



2 Touch **Audio**.



3 Touch **Change Audio** (Change Audio).

- Each time you touch **Change Audio** (Change Audio), the audio number changes, and the audio languages recorded on the video file change in sequence.



Q37

How can I change the aspect ratio of the USB video playback?

A37

1 Touch **Settings** (Settings).



2 Touch **Aspect** (Aspect).



3 Touch **Original** (Original) or **Zoom** (Zoom).

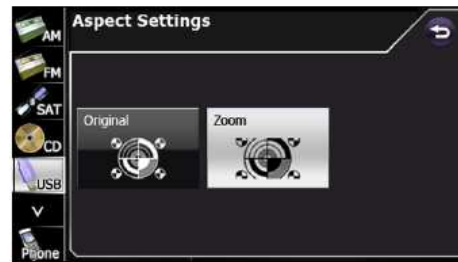

- **Original** (Original):
Display the video in its original size.
- **Zoom** (Zoom):
Expand the video until its vertical or horizontal dimension reaches the maximum size. (For DivX image files, the image is enlarged to 4.5 times its original size.)

Q38

How can I display the DIVX VOD (Video On Demand) registration code?

A38

To play DivX VOD (Video On Demand) content, first register this unit with the content provider. To register, the DivX VOD registration code is required.

You can display the DivX® Video On Demand registration code.

1 Touch **Info**.

- If **Info** is not displayed, touch **∨**.



2 Touch **DivX(R) VOD** (DivX(R) VOD).

- The DivX(R) VOD Set Up screen appears.

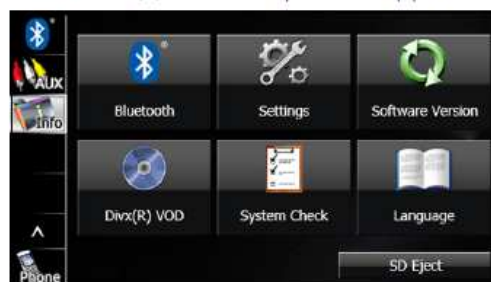

3 Touch **Register** (Register).



- Touch **OK** (OK) to return to the Info screen.





3. FAQ

Audio / Visual

Q39	What video formats are supported for USB video playback?
A39	DivX, Div, AVI, WMV, MP4, M4V

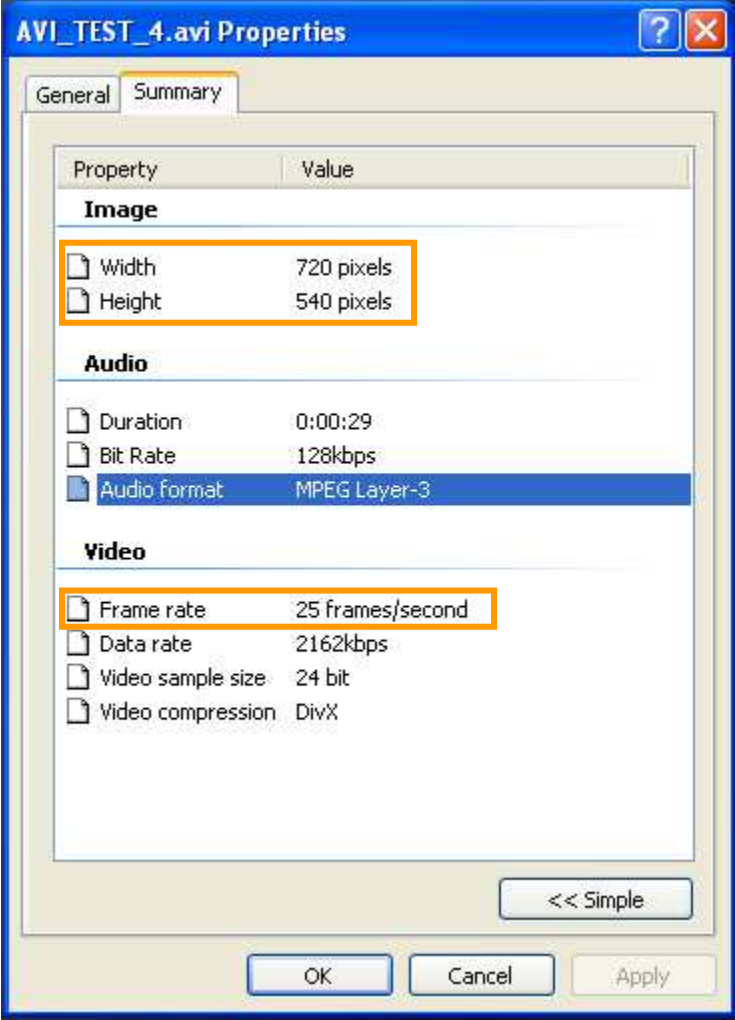
Q40	What is the maximum resolution and frame rate of the video files for USB video playback?
-----	--







A40	<p>720x480 (30 frame/second), 720x576 (25 frame rate / second)</p> <p>If the video resolution and frame rate do not meet the specification, “Video resolution not supported” or “Video Framerate not supported” is displayed and video will not be played.</p>  <p>The screenshot shows the 'AVI_TEST_4.avi Properties' dialog box with the 'Summary' tab selected. The 'Image' section shows 'Width' as 720 pixels and 'Height' as 540 pixels. The 'Audio' section shows 'Duration' as 0:00:29, 'Bit Rate' as 128kbps, and 'Audio Format' as MPEG Layer-3. The 'Video' section shows 'Frame rate' as 25 frames/second, 'Data rate' as 2162kbps, 'Video sample size' as 24 bit, and 'Video compression' as DivX. The 'Frame rate' and 'Image' sections are highlighted with orange boxes.</p>
-----	--

Q41	How can I play music (audio) from iPod?
A41	<ol style="list-style-type: none"> 1 Connect an iPod that contains music files to the iPod connector. 2 Press AUDIO. 3 Touch iPod. <ul style="list-style-type: none"> • The playback starts. 

Q42	How do I know if the connected iPod is recognized by the Navigation unit?
A42	<p>Once your iPod is connected to the USB port and recognized by the Navigation unit, iPod icon will be highlighted.</p> 

3. FAQ

Audio / Visual

Q43	How can I find a music files by Albums, Songs and Artists for iPod player?
A43	<ol style="list-style-type: none">1 Touch iPod.2 Touch Search (Search). A screenshot of the iPod Search screen. The top bar shows '12/345' and '2'51"'. Below the search bar, there are three categories: 'Album 01', 'Title 01', and 'Artist 01', each with a right-pointing arrow. At the bottom, there are 'Search' and 'Settings' buttons.3 To select a file or program to play, touch Playlists (Playlists), Albums (Albums), Artists (Artists), Songs (Songs) or Others (Others).<ul style="list-style-type: none">• The list screen for the selected mode appears.• Touch  to return to the previous screen. A screenshot of the iPod Playlists screen. The top bar shows '12/345', 'Album 01', and 'Title 01'. Below the top bar, there is a list of items: 'Playlist 01', 'Playlist 02', '1. Song 01', '2. Song 02', and '3. Song 03'. At the bottom, there are buttons for 'Playlists', 'Albums', 'Artists', 'Songs', and 'Others'. A back arrow icon is visible in the top right corner.
Q44	How can I repeat a song in the iPod?
A44	<ol style="list-style-type: none">1 Touch iPod.2 Touch Settings (Settings).3 Touch On (On) in Repeat.<ul style="list-style-type: none">• Repeat playback is set for the currently playing music file.• When you touch On (On), repeat is continued until you cancel it. Touch Off (Off) to cancel the repeat playback.• When Repeat is canceled, repeat playback is performed for the list that is playing back.• Touch  to return to the previous screen. A screenshot of the iPod Settings screen. The 'Repeat' option is highlighted with a yellow box, and the 'On' button is selected. Other options include 'Shuffle' (Album, Song, Off) and 'Audiobook Speed' (Slow, Normal, Fast). A back arrow icon is in the top right corner. <p>NOTE When On is selected in Repeat,  is displayed in the top right of the screen as confirmation that the function is on.</p>

Q45

How can I play music randomly with iPod?

A45

Playing files from the current list randomly

- 1 Touch **iPod**.
- 2 Touch **Settings** (Settings).
- 3 Touch **Song** (Song) in Shuffle.
 - When you touch **Song** (Song), random playback is continued until you cancel it. Touch **Off** (Off) to cancel random playback.
 - Touch  to return to the previous screen.

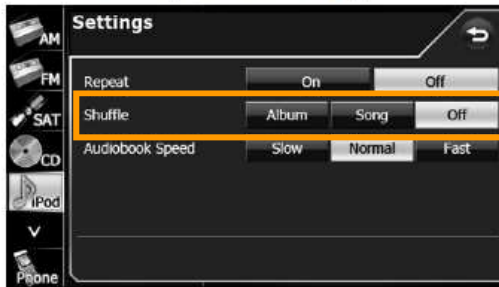

NOTE

When the list random function is selected,  is displayed in the top right of the screen as confirmation that the function is on.

Playing albums randomly

You can play albums randomly. Note that the music files within the albums are played in order from the first.

- 1 Touch **iPod**.
- 2 Touch **Settings** (Settings).
- 3 Touch **Album** (Album) in Shuffle.
 - When you touch **Album** (Album), random playback is continued until you cancel it. Touch **Off** (Off) to cancel random playback.
 - Touch  to return to the previous screen.

NOTE

When the album random function is selected,  is displayed in the top right of the screen as confirmation that the function is on.

3. FAQ

Audio / Visual

Q46 How can I play songs in “Shuffle Songs” mode with iPod?

A46 You can play all the music files randomly.

- 1 Touch **iPod**.
- 2 Touch **Shuffle Songs** (Shuffle Songs).
 - When you touch **Shuffle Songs** (Shuffle Songs), random playback is continued until you cancel it.



NOTE

When the all random function is selected,  is displayed in the top right of the screen as confirmation that the function is on.

Q47 How can I change the audiobook playback speed?

- 1 Touch **iPod**.
- 2 Touch **Settings** (Settings).
- 3 Touch **Slow** (Slow), **Normal** (Normal) or **Fast** (Fast) in Audiobook Speed.
 - **Slow** (Slow):
Slow down the reading speed of the audiobook.
 - **Normal** (Normal):
Set the reading speed of the audiobook to normal.
 - **Fast** (Fast):
Speed up the reading speed of the audiobook.
 - Touch  to return to the previous screen.

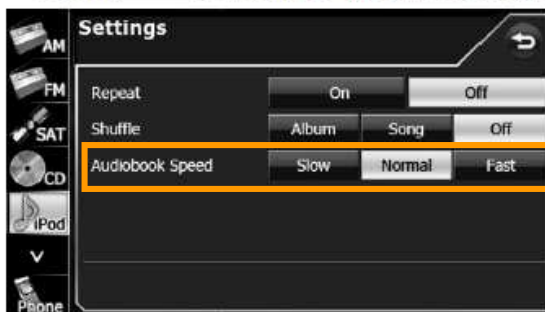

Q48 Which iPods are supported by the Navigation unit?

A48	Type	Generation	Firmware version or OS
	iPod	5G	1.3
	iPod nano	1G	1.3.1
		2G	1.1.3
		3G	1.1.3
		4G	1.0.4
		5G	1.0.2
	iPod classic	1G	1.1.2
		2G (120 GB)	2.0.1
		2009 (160 GB)	2.0.4
	iPod touch	1G	iOS 3.1.3
		2G	iOS 4
		Late 2009 (8 GB/16 GB)	iOS 4
		Late 2009 (32 GB/64 GB)	iOS 4
		3G	iOS 3.1.3
	iPhone	1G (iPhone)	iOS 4
		2G (iPhone 3G)	iOS 4
		3G (iPhone 3GS)	iOS 4
		iPhone 4	iOS 4

Q49 Can pictures or photography from the iPod be displayed on the Navigation unit?

A49 No. Pictures stored on the iPod cannot be shown on the display

Q50 Are Podcasts supported in iPod mode?





A50 Yes, but it may operate differently

Q51 Can I charge my iPod with the Navigation unit?

A51 Yes

3. FAQ

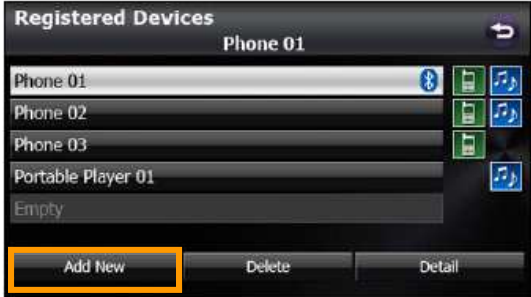
Audio / Visual

Q52	What profiles are required to listen to Bluetooth Audio?
A52	<ul style="list-style-type: none"> • A2DP (Advanced Audio Distribution Profile) Ver. 1.0 or higher • AVRCP (Audio/Visual Remote Control Profile) Ver.1.0 or higher (Ver. 1.4 or higher is recommended) <p>NOTE The available functions may vary depending on the type of Bluetooth audio device.</p>
Q53	How many Bluetooth Audio devices can be registered to the Navigation unit?
A53	Up to 5 devices
Q54	How can I register my Bluetooth portable device to the Navigation unit?
A54	<ol style="list-style-type: none"> 1 Press AUDIO. 2 Touch Info. <ul style="list-style-type: none"> • If Info is not displayed, touch ∨. 3 Touch Bluetooth.  4 Touch Registered Devices (Registered Devices).  5 Touch Add New (Add New).  6 Operate the portable device to enter the passcode (passkey) of the unit. <ul style="list-style-type: none"> • The name of the unit is CAR MULTIMEDIA. • The initial setting for the passcode (passkey) is 0000. • Operate the portable device while the Registered Devices screen is displayed. <p><Registered Devices screen></p>  7 When the registration is complete, "Connection Completed" appears. <ul style="list-style-type: none"> • The portable device registration is complete. • After the registration completed message is displayed, "Connection established successfully!" appears.

Q55

How can I connect my Bluetooth Audio device to the Navigation unit?

A55

You can connect portable devices that are registered on the unit.

- Make the preparations necessary for connecting to the unit, for example by setting the portable device's Bluetooth standby to On. For details of operations on the portable device, see the portable device's instruction manual.

1 Press **AUDIO**.

2 Touch **Info**.

- If **Info** is not displayed, touch **∨**.

3 Touch **Bluetooth**.

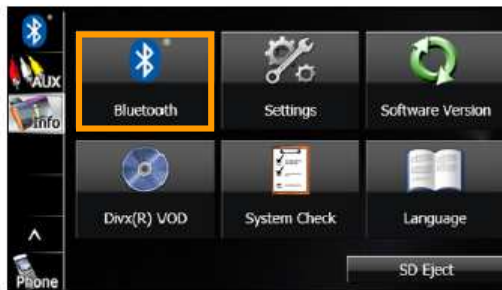

4 Touch **Connect Portable Player** (Connect Portable Player).



5 Select the portable device that you want to connect.

- The Bluetooth mark is displayed for portable devices with an active Bluetooth connection.



6 Touch **Connect** (Connect).

- The connection screen appears.

7 When the connection is complete, "Connection Completed" appears.





- The connection between the portable device and the unit is complete.

NOTE

- If the connection fails, "Connection failed." appears on the screen. If this happens, perform the connection operation again.
- Connection is not possible if no portable devices are registered.
- On the Connect Portable Player screen, touch **Add New** (Add New) to register a portable device.

3. FAQ







Audio / Visual

Q56	How can I play Bluetooth Audio?
A56	<p>Before playing Bluetooth Audio, please make sure your Bluetooth device has been registered and connected.</p> <ol style="list-style-type: none">1 Press .2 Touch .3 Touch . <ul style="list-style-type: none">• The playback starts on the connected portable device.  <p>NOTE</p> <ul style="list-style-type: none">• If the playback does not start when you touch  on the unit, press the play button on the portable device.• Album, Title, and Artist name may not be displayed depending on the portable device type.
Q57	Why iTunes downloaded music won't play in USB audio player?
A57	USB audio player only supports MP3 and WMA music files and won't support AAC file from iTunes store.
Q58	Can I play DVD movies?
A58	No, unit won't play DVD movies, however video contents (DivX, Div, AVI, WMV, MP4, M4V) can be played using USB flash memory.

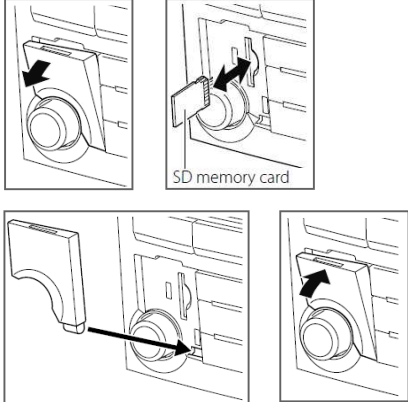
MEMO

3. FAQ

Others

Q1	How can I play a picture Slide Show?
A1	<p>Before inserting an SD memory card that contains image data, touch SD Eject (SD Eject) and remove the map SD card.</p> <ol style="list-style-type: none">1 Insert a different SD memory card that contains image data.2 Display the picture operations screen.  <p>Caution: Do not add photo data on Map SD Card. It may damage the software file. Always use a different SD card to store photo data.</p> <p>Remove/Attach SD Card Cover:</p>  <ul style="list-style-type: none">• Menu (Menu): You can display a picture list or set a slide show.• : Display the previous image.• : Display the next image.•  (or ): The slide show starts. Touch  to stop the slide show.• Start-up Screen (Start-up Screen): Register the displayed image data as the “Customized” opening screen setting.
Q2	How can I replace the Subaru Opening Screen with my own picture?
A2	<p>You can register image data (1 picture only) imported from an SD memory card as the “Customized” opening screen setting.</p> <ol style="list-style-type: none">1 Insert an SD memory card that contains the image data.2 Display the image that you want to set and touch Start-up Screen (Start-up Screen).  <ol style="list-style-type: none">3 “Are you sure to overwrite the start-up screen?” appears on the screen. Touch Yes (Yes). <ul style="list-style-type: none">• The picture is registered as the “Customized” opening screen setting.

Q3	Do I lose the Subaru Opening screen once it is replaced with my own picture?
A3	<p>No.</p> <p>You can select either the Subaru logo (default) or your picture as the Opening Screen.</p> <ol style="list-style-type: none"> 1. Press "Audio" 2. Touch "Info" 3. Touch "Settings" <p>In start up Screen, you can select "Customized (your picture)" or "Initialize (Subaru logo)"</p>
Q4	Which picture format is required for a picture Slide Show?
A4	.jpg
Q5	What is the maximum number of pictures and image size allowed for a picture Slide Show?
A5	Up to 500 pictures and 10MB or less per file
Q6	Can I watch a picture Slide Show while driving?
A6	No.
Q7	Can I view pictures that are stored on CD-R / DVD-R with the Navigation unit?
A7	No.

3. FAQ

Others

Q8 How can I set or adjust the clock?

A8 Current time can be adjusted automatically using GPS signals or manually.

1 On the Info screen, touch **Settings** (Settings). 3 Touch **On** (On) or **Off** (Off) in Auto Time Zone.



2 Touch **Set** (Set) in Time Zone.

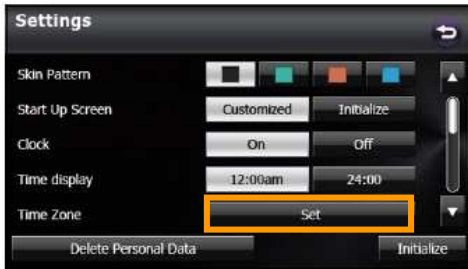

- Touch **On** (On) in Auto Time Zone to set the time zone automatically.
- When Auto Time Zone is "Off", touch **-** or **+** in Manual Time Zone to adjust the time zone manually.
- Touch **+** for 1 second or more to raise the time continuously. Touch **-** for 1 second or more to lower the time continuously.
- After configuring the setting, touch **Done** (Done) to save the setting and return to the previous screen.

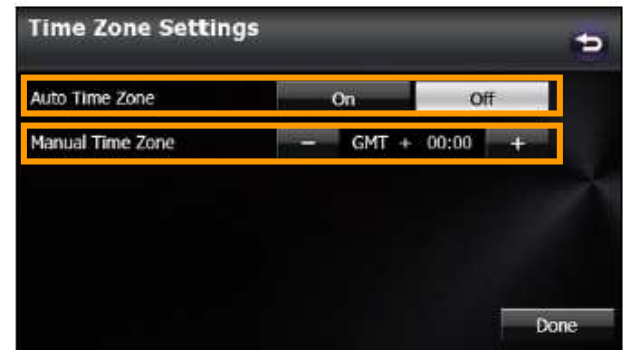

Q9 How can I turn off the "Guide Tone (Beep)"?

A9 You can set the sound for button operations to on or off.

1 On the Info screen, touch **Settings** (Settings).

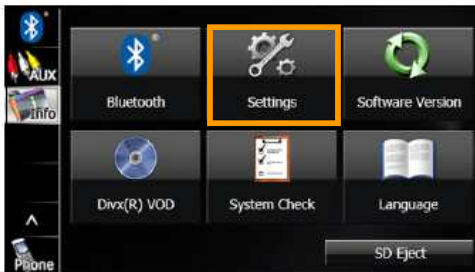

2 Touch **On** (On) or **Off** (Off) in Guide Tone.

- If Guide Tone is not displayed, touch **▼** to change the page.
- When Guide Tone is set to "Off", button operations do not emit a sound.



Q10

What "Personal Data" will be deleted by touching "Delete Personal Data" button?

A10

You can delete the data items that you registered and return them to the factory default value.

Deleted personal data items

Item	Deleted data
Navigation	<ul style="list-style-type: none"> • Navigation settings • Map display setting • Route learning function • Indication setting of facilities • Current position
Settings	<ul style="list-style-type: none"> • Clock setting • Language Setting • Guide tone setting • Skin pattern setting, Opening screen setting (including data registered in "Customized") • Screen settings • Day/night view changeover setting • Voice recognition setting (including song data and phone book data) • Display settings for the "SD Eject" caution screen
General audio	<ul style="list-style-type: none"> • Volume setting • Sound quality setting • Screen setting
Radio	<ul style="list-style-type: none"> • AM/FM/SAT preset channels • Parental Lock setting
Bluetooth audio	<ul style="list-style-type: none"> • Bluetooth audio registered data • Settings and edited items related to Bluetooth audio
Handsfree	<ul style="list-style-type: none"> • Phone book data • Outgoing call history and incoming call history • Speed Dial data • Bluetooth phone registered data • Unread messages and read messages • Reply Messages list • Settings and edited items related to handsfree messages

How to delete personal data

- 1 Touch **Info**.
 - If the Navigation screen is displayed, change to the Multi screen or Audio operations screen before performing this operation.
 - If **Info** is not displayed, touch **▼**.

- 2 Touch **Settings** (Settings).

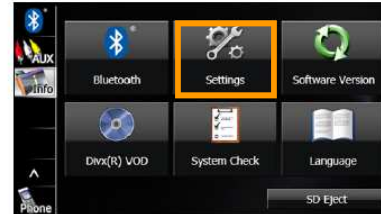

- 3 Touch **Delete Personal Data** (Delete Personal Data).



- 4 Touch **Delete** (Delete).

- Touch **Do Not Delete** (Do Not Delete) to cancel the Delete Personal Data.

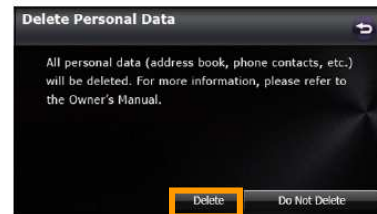

- 5 Touch **Yes** (Yes).

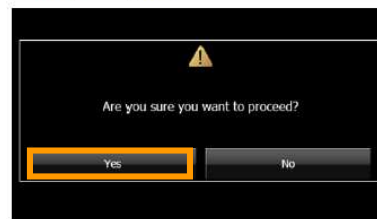





NOTE

Once the information (data) is initialized (deleted), it cannot be restored. Be very careful when performing initialization.

3. FAQ

Others

Q11	What items will be initialized by touching the “Initialize” button?
A11	<p>Settings of Skin Pattern, Start Up Screen, Clock, Time Display, Time Zone, Link to Day/Night View, Voice Recognition and Guide Tone will be reset to the factory default</p>  <p>The screenshot shows the 'Settings' application. At the bottom right, the 'Initialize' button is highlighted with a yellow border. Other visible options include 'Skin Pattern', 'Start Up Screen' (with 'Customized' and 'Initialize' buttons), 'Clock' (with 'On' and 'Off' buttons), 'Time display' (with '12:00am' and '24:00' buttons), and 'Time Zone' (with a 'Set' button). A 'Delete Personal Data' button is also visible at the bottom left.</p>



Q12	How can I adjust the volume level of Voice Guidance?
A12	<ol style="list-style-type: none"><li data-bbox="261 968 878 1003">1 On the Info screen, touch Settings (Settings)<li data-bbox="261 1325 992 1436">2 Touch Set (Set) in Voice Recognition.<ul style="list-style-type: none"><li data-bbox="305 1373 992 1436">• If Voice Recognition is not displayed, touch ▼ to change the page.<li data-bbox="932 974 1214 1150">3 Touch - or +.<ul style="list-style-type: none"><li data-bbox="976 1024 1182 1087">• + (right side): Volume up<li data-bbox="976 1094 1166 1150">• - (left side): Volume down  <p>The screenshot shows the 'Info' screen with several icons. The 'Settings' icon, which is a gear, is highlighted with a white border.</p>  <p>The screenshot shows the 'Voice Recognition Settings' screen. A volume slider is visible, with the 'Voice Guidance Volume' label above it. The slider has a minus sign on the left and a plus sign on the right. An 'Initialize' button is located at the bottom right.</p>  <p>The screenshot shows the 'Settings' application. The 'Voice Recognition' option is highlighted with a white border. Other visible options include 'Link to Day/Night View' (with 'Headlight', 'Time', and 'None' buttons) and 'Guide Tone' (with 'On' and 'Off' buttons). 'Delete Personal Data' and 'Initialize' buttons are at the bottom.</p>

Q13	How can I check the Software (Navigation & Audio) version?
A13	<ol style="list-style-type: none"> 1. Press "Audio" 2. Touch "Info" 3. Touch "Software version"
Q14	How can I check the system conditions (GPS, Parking Brake, Reverse signals)?
A14	<ol style="list-style-type: none"> 1. Press "Audio" 2. Touch "Info" 3. Touch "System Check"  <p>The screenshot shows a 'System Check' screen with a back arrow in the top right corner. It lists three items: 'GPS' with a signal strength indicator of '4', 'Parking Brake' with the status 'On', and 'Reverse' with the status 'Off'.</p>
Q15	Can I make a back-up copy of the MAP SD card and restore the content to another SD card?
A15	No. Only authentic genuine Subaru SD MAP card will work.

4. Glossary

[A] - [M]

[Alphabetical Order]

Term	Definition
Aha	Aha is a comprehensive “automotive grade” cloud platform, providing automotive manufacturers a single integration point to bring the widest range of current and future Web infotainment content safely into their vehicles. <i>Note: Aha Radio is not available for 86271AJ67A and 86271AJ77A</i> 
AUX	AUX (Auxiliary Port [Input]) is an analog audio connector, which has a 3.5mm audio jack.
Bluetooth (B/T)	Bluetooth is a high-speed wireless data communication system that uses the 2.4 GHz frequency band prescribed by the Bluetooth SIG (Special Interest Group), with communication at a speed of up to 1 Mbps. Bluetooth is a trademark owned by Bluetooth SIG, Inc. 
Copy-control CD Label Gate CD	This refers to music data that is encoded to prevent saving, alteration, or storing of music data on a computer or other electronic device. Copy Control CDs and Label Gate CDs are labeled with the following symbol. Before using, be sure to refer to information that comes with the product. 
DivX	DivX is a brand name of products created by DivX, Inc., including the DivX Codec which has become popular due to its ability to compress lengthy video segments into small sizes while maintaining relatively high visual quality.
Green route	Searches for the route that conserves the most energy, taking into account the merits of “Fast” and “Short”.
GPS (Global Positioning System)	GPS is positioning system that utilizes satellites traveling at high speed along a 21,000 km orbit. These satellites emit electromagnetic waves that allow the longitude, latitude and height of a given position to be identified.
HD radio	HD Radio, which originally stood for "Hybrid Digital", is the trademark for iBiquity's in-band on-channel (IBOC) digital radio technology used by AM and FM radio stations to transmit audio and data via a digital signal in conjunction with their analog signals. <i>Note: HD Radio service available in USA only (as of May 2013)</i>
iPhone	iPhone is a smartphone designed and marketed by Apple.
iPod	iPod is a portable media player designed and marketed by Apple.
MP3	MP3 is short for MPEG Audio Layer 3, and is a standard format for audio compression technology. MP3 compresses sound data to eliminate sounds that are outside the range of human hearing, allowing the original file to be compressed to 1/10th their size.

4. Glossary

[N] - [S]

Term	Definition
Navigation System	Navigation system is capable of containing map data, determining a vehicle's location and providing suggested direction.
NAVTEQ	Navteq is a Chicago, Illinois-based provider of Geographic Information Systems data and is a dominant company in providing the base electronic navigable maps. The company is a wholly owned subsidiary of Nokia but operates independently.
MP4	MP4(MPEG-4) is a multimedia container format standard specified as a part of MPEG-4.
PKB-SIGNAL (Parking Brake-Signal)	This is a signal that activates when the parking brake is on.
Positioning	Vehicle position can be obtained when information is received from 3 or more GPS satellites.
REV-SIGNAL (Reverse-Signal)	This is a signal that activates when the shift lever is put into Reverse.
Satellite radio	Satellite radio is an analogue or digital radio signal that is relayed through one or more satellites and thus can be received in a much wider geographical area than terrestrial FM radio stations.
SD	SD (Secure Digital) is a non-volatile memory card format developed by the SD Card Association for use in portable devices.
SMS	SMS (Short Message Service) is a text messaging service component of phone, web, or mobile communication systems, using standardized communications protocols that allow the exchange of short text messages between fixed line or mobile phone devices.
SPD-SIGNAL (Speed-Signal)	This indicates the vehicle speed pulse signal generated by movement of the vehicle.
SACD (Super Audio CD)	A high-quality audio disc standard that utilizes the DSD (Direct Stream Digital) format. This format enables digital recording in a form extremely similar to analog waves of the original.

4. Glossary

[U] - [number]

Term	Definition
USB (Universal Serial Bus)	USB is a specification to establish communication between devices and a host controller. USB flash drive consists of a flash memory storage device integrated with a USB 1.1 or 2.0 interface.
WMA (Windows Media Audio)	WMA is an audio data compression technology developed by Microsoft.
WMV (Windows Media Video)	WMV is a video data compression technology developed by Microsoft.
XM	XM Satellite Radio is one of two satellite radio services in the United States and Canada, operated by Sirius XM Radio.
2-dimensional and 3-dimensional positioning	GPS calculates position based on a three-point system. Distance from the first satellite is first calculated, and then current position is calculated using information received from three satellites. Even if signals are received from 3 GPS satellites, only latitude and longitude can be measured, giving 2-dimensional positioning. This results in lower accuracy. When information can be obtained from 4 satellites, latitude, longitude, and height measurements can be obtained for 3-dimensional positioning. This is more accurate than 2D positioning, and results in a decreased occurrence of vehicle positioning errors.

