

ATTENTION:

- GENERAL MANAGER
- PARTS MANAGER
- CLAIMS PERSONNEL
- SERVICE MANAGER

IMPORTANT - All Service Personnel Should Read and Initial in the boxes provided, right.

© 2021 Subaru of America, Inc. All rights reserved.



QUALITY DRIVEN® SERVICE

SERVICE BULLETIN

APPLICABILITY: 2019-21MY Crosstrek PHEV

NUMBER: 09-82-23

SUBJECT: DTC P0452 EVAP System (CPC) Pressure Sensor/Switch Circuit Low
Design Changes to Fuel Tank Assembly & Vent Tubes

DATE: 10/02/23

REVISED: 01/08/24

INTRODUCTION:

This bulletin announces design changes made to the fuel tank and vent tubes. An enhanced material has been incorporated into the production of these components. If DTC P0452 is stored in the engine control module (ECM), the information in this bulletin **MUST** be used to ensure an accurate diagnosis. Fuel types with high alcohol (ethanol) content may react with the fuel tank resin and cause clogging within the fuel tank components. The new fuel tank and vent tubes use a material with increased resistance to alcohol.

PRODUCTION CHANGE INFORMATION:

The production change information for Crosstrek PHEV is TBD.

PART INFORMATION:

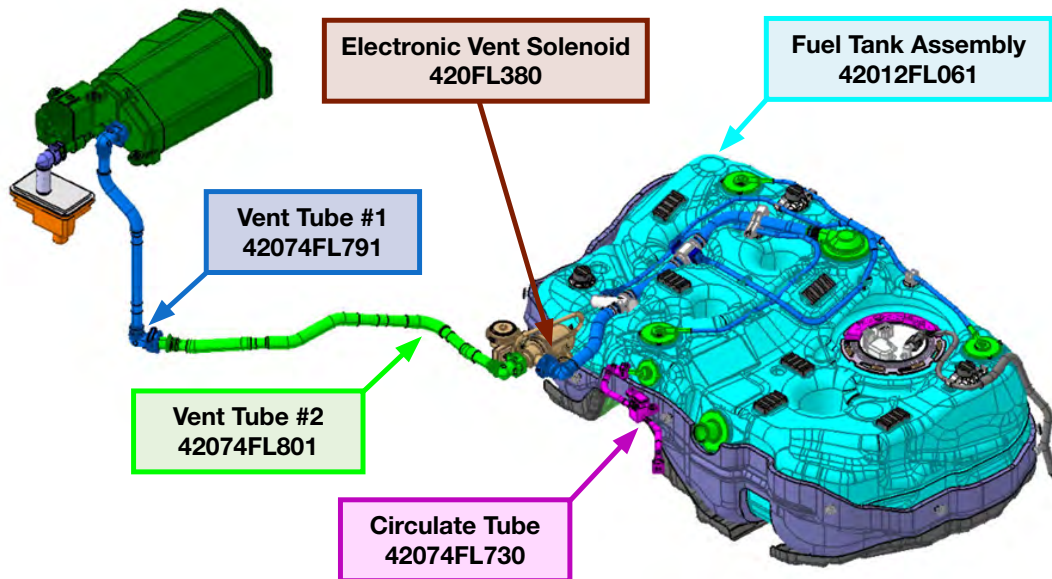

<p>CAUTION: VEHICLE SERVICING PERFORMED BY UNTRAINED PERSONS COULD RESULT IN SERIOUS INJURY TO THOSE PERSONS OR TO OTHERS.</p> <p>Subaru Service Bulletins are intended for use by professional technicians ONLY. They are written to inform those technicians of conditions that may occur in some vehicles, or to provide information that could assist in the proper servicing of the vehicle. Properly trained technicians have the equipment, tools, safety instructions, and know-how to do the job correctly and safely. If a condition is described, DO NOT assume that this Service Bulletin applies to your vehicle, or that your vehicle will have that condition.</p>	<p style="text-align: center;">Subaru of America, Inc. is ISO 14001 Compliant</p> <p>ISO 14001 is the international standard for excellence in Environmental Management Systems. Please recycle or dispose of automotive products in a manner that is friendly to our environment and in accordance with all local, state and federal laws and regulations.</p>
--	--

Continued...

IMPORTANT NOTE: No design changes were made to the Circulate Tube or the Electronic Vent Solenoid.

Part Description	Part Number
TANK COMPLETE-FUEL	42012FL061
TUBE-AIR VENT	42074FL791
TUBE-AIR VENT	42074FL801
TUBE ASSEMBLY	42074FL730
VALVE-VENT	42084FL380

REMINDER: Always order the most up-to-date replacement parts based on the specific VIN being repaired.

SERVICE PROCEDURE / INFORMATION:

REMINDER: Customer satisfaction and retention starts with performing quality repairs.

NOTE: Refer to the applicable Service Manual and review: General Description > Repair Contents > Action required before & after Battery Disconnect. Additionally, record any stored seat position(s) before proceeding. Relearn any seat position memory after work is complete. If the power rear gate (PRG) height has been customized, that position must also be noted and relearned.

STEP 1) Perform a fault scan and confirm DTC P0452 is stored in the ECM.

STEP 2) Check the data monitor. Is the value of the Fuel Tank Pressure Sensor -2.65kPa (-19.88 mmHg, -0.78inHg) or less?

No  With DTC P0452 detected, the circuit has returned to a normal condition at this time. Reproduce the fault and repeat diagnosis.

Yes  Check the Tank Pressure Sensor power supply for short to ground (see wiring diagram provided below).

Connector & Terminal (AD93) No. 3 (+) – Chassis Ground (-):
Is the voltage 4.5 Volts or more?

No  Repair the harness and/or the connector.

Yes  Proceed to the next Step.

STEP 3) Check the harness between the ECM and the Fuel Tank Pressure Sensor for short to ground.

Connector & Terminal (B134) No. 59 (+) – Chassis Ground (-):

Is the resistance 1 MΩ or more?

No  Repair the short to ground within the harness between the ECM and the Fuel Tank Pressure Sensor.

Yes  Proceed to the next Step.

Continued...

STEP 4) Check for poor contacts. Is there a poor contact found within the Fuel Tank Pressure Sensor Connector?

No  Replace the Circulate Tube Assembly. Refer to the applicable Service Manual: ENGINE > FUEL INJECTION (FUEL SYSTEMS)(H4DO)(HEV) > Circulate Tube Assembly.

Yes  Proceed to the next Step.

STEP 5) Check the Fuel Tank Pressure Sensor Signal.

Connector & Terminal (AD94) No. 2 (+) – Chassis Ground (-):

Is the voltage 2.2V or more?

No  Replace the Circulate Tube Assembly.

Yes  Proceed to the next Step.

STEP 6) Perform Electronic Vent Solenoid inspection.

Refer to the applicable Service Manual: Engine > EMISSION CONTROL (AUX. EMISSION CONTROL DEVICES)(H4DO(HEV)) > Electric Vent Solenoid Valve Assembly > Inspection.

Is the resistance between terminal 1 & 2 approximately 34Ω and all the connections secure?

No  Replace the Electronic Vent Solenoid:

Refer to the applicable Service Manual: Engine > EMISSION CONTROL (AUX. EMISSION CONTROL DEVICES)(H4DO(HEV)) > Electric Vent Solenoid Valve Assembly.

Visually inspect the internal condition of the Evaporative Line connections to the Electronic Vent Solenoid:

1. Resin Tube on the Fuel Tank Assembly (attached directly to the Vent Solenoid)
2. Vent Tube #1
3. Vent Tube #2

If any deposits/build-up is found inside the tube(s), replace all the Vent Tubes and Fuel Tank Assembly.

Yes  Proceed to the next Step.

STEP 7) Inspect the evaporative system lines, hoses, and tubes for any deformation, cracks, or any other physical damage. Replace any affected items as necessary.

Continued...

IMPORTANT NOTE: Whenever reconnecting the ground cable terminal to the battery sensor, torque to 7.5Nm (5.5ft.-lbs. or 66inch-lbs.) while supporting the sensor with the other hand as outlined in the applicable Service Manual under: STARTING/CHARGING SYSTEMS > Battery Sensor.

Wiring Diagram:

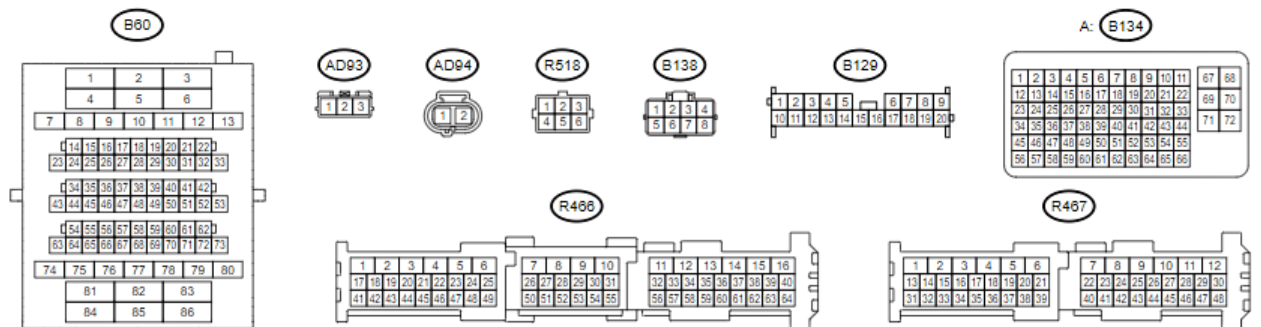
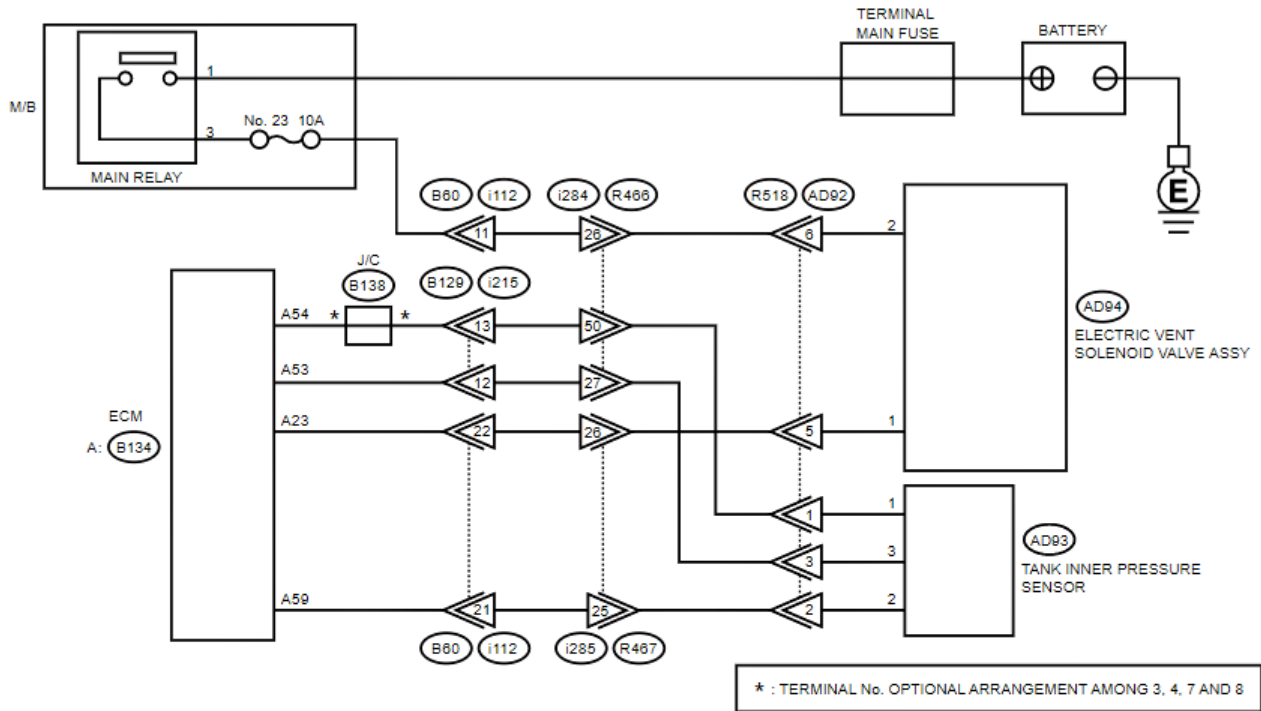

Continued...

WARRANTY / CLAIM INFORMATION:

For vehicles within the Basic New Car Limited Warranty period or covered by an active Subaru

Added Security Gold plan, this repair may be submitted using the following claim information:

Labor Description	Labor Operation #	Labor Time	Fail Code
FUEL TANK, VENT SOLENOID AND TUBES R&R	B469-202	3.0	DBB22
EVAPORATIVE SYSTEM PRESSURE DIAGNOSIS	C458-001	1.2	

For vehicles registered in Cal ZEV states TZEV warranty is available.

IMPORTANT REMINDERS:

- SOA strongly discourages the printing and/or local storage of service information as previously released information and electronic publications may be updated at any time.
- Always check for any open recalls or campaigns anytime a vehicle is in for servicing.
- Always refer to STIS for the latest service information before performing any repairs.

Continued...