

**ATTENTION:**

- GENERAL MANAGER
- PARTS MANAGER
- CLAIMS PERSONNEL
- SERVICE MANAGER

IMPORTANT - All Service Personnel Should Read and Initial in the boxes provided, right.



QUALITY DRIVEN® SERVICE

## SERVICE BULLETIN

**APPLICABILITY:** 2013MY BRZ **NUMBER:** 15-158-12  
**SUBJECT:** Navigation/GPS Antenna Changes **DATE:** 10/24/12  
 SD Card Exchange Program Information

### INTRODUCTION

The purpose of this bulletin is to provide installation procedures for changes to the Fujitsu-Ten navigation system’s operating software and GPS antenna / mounting bracket assembly. Countermeasures have been developed to address customer concerns of GPS signal loss, incorrect vehicle location or vehicle direction (arrow) display and system “freeze”. The countermeasures consist of an exchange SD card containing updated operating software to address these customer concerns in addition to a revised GPS antenna /mounting bracket assembly which repositions the GPS antenna.

**NOTE:** The exchange SD card will not update the navigation system’s map data in any way.

If the condition is other than what is described here, this bulletin does not apply and the audio/navigation unit should be diagnosed using the appropriate Fujitsu Ten Troubleshooting Guide and the applicable Service Manual.

### COUNTERMEASURE IN PRODUCTION

COUNTERMEASURE	STARTING VIN NUMBER
Revised GPS Antenna / Mounting Bracket Assembly	D*603651
Software Change	D*603932

### PART INFORMATION

The photo below shows the exchange SD card. It can be identified by the orange paint dot in lower left corner of the label. Some cards received through the exchange program may have an additional green dot present. The presence of this green dot is unrelated to this condition and SD cards with or without it will function similarly.



The part number for the revised GPS antenna / mounting bracket assembly is: 86277CA110. The SD card will be available on an **exchange basis**

**only.** Use the revised Fujitsu-Ten Exchange Form which can be found on: Subarunet > Service > Forms > TomTom/Fujitsu Ten Exchange Request Form.

*Continued...*

**CAUTION: VEHICLE SERVICING PERFORMED BY UNTRAINED PERSONS COULD RESULT IN SERIOUS INJURY TO THOSE PERSONS OR TO OTHERS.**

Subaru Service Bulletins are intended for use by professional technicians ONLY. They are written to inform those technicians of conditions that may occur in some vehicles, or to provide information that could assist in the proper servicing of the vehicle. Properly trained technicians have the equipment, tools, safety instructions, and know-how to do the job correctly and safely. If a condition is described, DO NOT assume that this Service Bulletin applies to your vehicle, or that your vehicle will have that condition.

**SUBARU OF AMERICA, INC. IS "ISO 14001 COMPLIANT"**

The international standard for excellence in Environmental Management Systems. Please recycle or dispose of automotive products in a manner that is friendly to our environment and in accordance with all local, state and federal laws and regulations.

Always download and use the latest form from Subarunet for these requests. Be sure to scrap any previously printed versions of this form to prevent confusion.

**This change identifies this form as the latest version.**



**Fujitsu Ten Advance Exchange Fax Form**  
TomTom Navi System / AVN SD Card Navi System



Fax Form to: **1-800-438-5410**  
If you have any questions, you may contact us at 1-800-237-5413

---

**Step 1: Initial Questions:**

Did you duplicate customer complaint?  
 Yes  
 No



Did you use Troubleshooting Guide?  
 Yes → Did it help?  Y  N  
 No → It is available on STIS

Did you contact Technical Assistance?  
 Yes → Case #: \_\_\_\_\_  
 No

**Step 2: Which system do you need?**

**TomTom Navigation System**

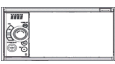

Unit  PND

 or 

Subaru Part Number: \_\_\_\_\_

**AVN SD Card Navigation System**

Unit with SD card  SD card Only 

 or 

Subaru Part Number: \_\_\_\_\_

Note: SD Card is model specific. Please verify the part # is correct

---

**Step 3: When did problem occur? Write in date and time of occurrence, Check all that apply.**

\_\_\_\_\_ (month), \_\_\_\_\_ (date), \_\_\_\_\_ (clock time)

Occur only once  Always occur  Occur \_\_\_ times within the past \_\_\_\_\_.

**Where did problem occur? (Ex. Ordinary road, Freeway, Underground parking etc.)**

\_\_\_\_\_

**What were the situations?(Ex. High-speed driving, Driving at rough road, Parking)**

\_\_\_\_\_

**What did customer operate? (Ex. ACC-ON, Insert disc, Press specific button)**

\_\_\_\_\_

**Discription of problem (Please use as much detail as possible):**

\_\_\_\_\_

**BLUETOOTH (Phone)**

Will not pair:  
Phone Carrier \_\_\_\_\_

Make \_\_\_\_\_

Model \_\_\_\_\_

Can't Hear:  
 Receiver  
 Caller

Sounds Garbled

Address book will not transfer

Other Explain: \_\_\_\_\_

---

**RADIO**

AM, Station: \_\_\_\_\_

FM, Station: \_\_\_\_\_

XM, Station: \_\_\_\_\_

HD, Station: \_\_\_\_\_

No Sound

No/Poor Reception

Noise/Static

Sound cuts in/out

Other Explain: \_\_\_\_\_

Other Audio Problem (DVD, USB, iPod, AUX) Explain: \_\_\_\_\_

**CD/DVD**

Won't Accept CD

Won't Eject CD

Won't Play

CD Skips

No Sound

Noise

Sound cuts in/out

Shows Error

Other Explain: \_\_\_\_\_

**NAVIGATION**

No Voice Guidance

Guidance volume too low

Inaccurate vehicle position

Won't read Data

Won't update

Destination/Route problem

Navi screen freezes

Overall Navi operation slow

Other Navi Function List problem: \_\_\_\_\_

Other (Explain) \_\_\_\_\_

**DISPLAY/TOUCH SCREEN**

No Display

Display Abnormal

Brightness/Contrast

Discoloration

No Rear Camera

Freezes

Shows Error/Caution

Slow Response

Other Display Function List problem: \_\_\_\_\_

Other (Explain) \_\_\_\_\_

**BLUETOOTH (Audio Stream)**

Will not pair:  
Device \_\_\_\_\_

Won't Play

No Sound

Noise

**PND Battery**

PND stops charging

PND does not charge

---

**Step 4: WARRANTY:**  YES  NO

Date: \_\_\_\_\_ Dealer Name: \_\_\_\_\_

Dealer Code: \_\_\_\_\_ Dept: \_\_\_\_\_ Repair Order Number: \_\_\_\_\_

Contact Name: \_\_\_\_\_ Mileage: \_\_\_\_\_

Date of First Use: \_\_\_\_\_ VIN: \_\_\_\_\_

Customer Name: \_\_\_\_\_ Phone: \_\_\_\_\_ Fax: \_\_\_\_\_

---

**Response from Fujitsu Ten (F-Ten use only)**

Claim Number: \_\_\_\_\_

Comment to Dealer: \_\_\_\_\_

Continued...

## SERVICE PROCEDURE / INFORMATION

**IMPORTANT:** Be sure to verify the condition(s) as described by the customer is within the context of this bulletin before performing any repairs. After verification, order the revised GPS antenna / mounting bracket assembly through normal parts channels. Request the exchange SD card by submitting a **COMPLETED** Fujitsu-Ten Exchange Fax Form. Once you have received **BOTH** components, continue with the rest of this procedure as they must be installed at the same time.

### NOTES:

- It is not necessary to disconnect the battery terminals before performing this procedure.
- Check and ensure that the battery has sufficient charge to proceed. **NOTE:** Battery failure during programming will result in internal audio head unit damage that cannot be repaired.
- Because the navigation / audio unit will be removed, the customer's radio station pre-sets and navigation system favorites should be recorded then reset once the procedure has been completed.

Remove the audio unit trim panel using a plastic trim tool. **CAUTION:** Be extremely careful not to damage the surrounding dash trim surfaces.

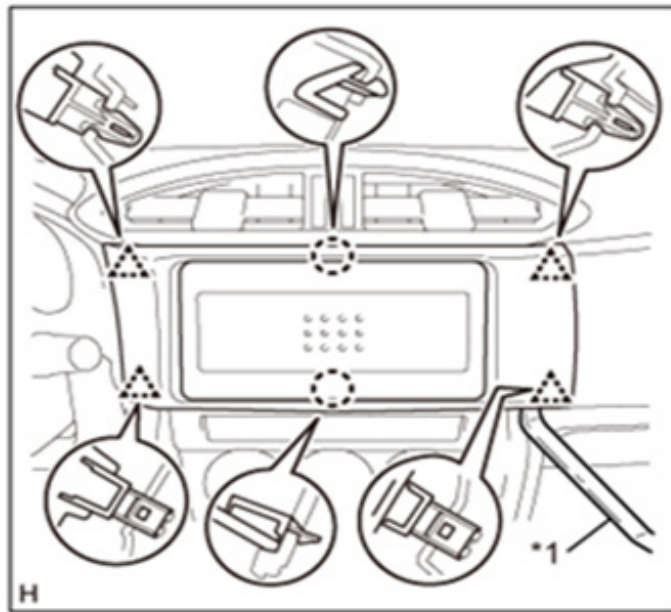

After removing the navigation / audio unit trim panel, confirm there are no retaining clips remaining in the instrument panel as shown in the photo below left. All 4 clips must be returned to the panel before reinstallation.

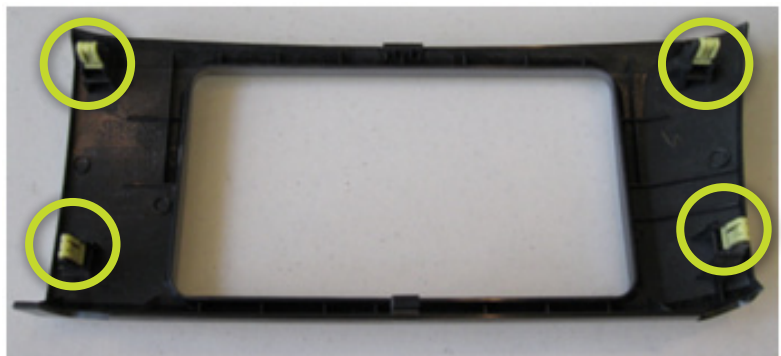
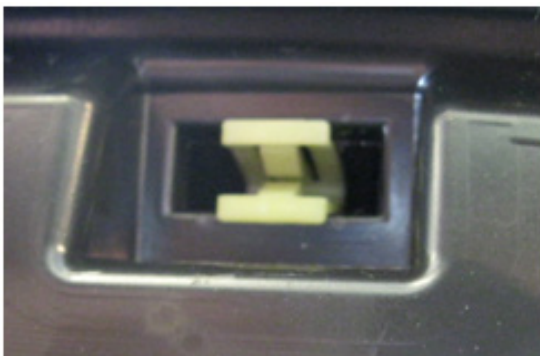

*Continued...*

Remove the 4 bolts which secure the navigation / audio unit then carefully slide it out to gain access to the existing GPS antenna / mounting bracket assembly.

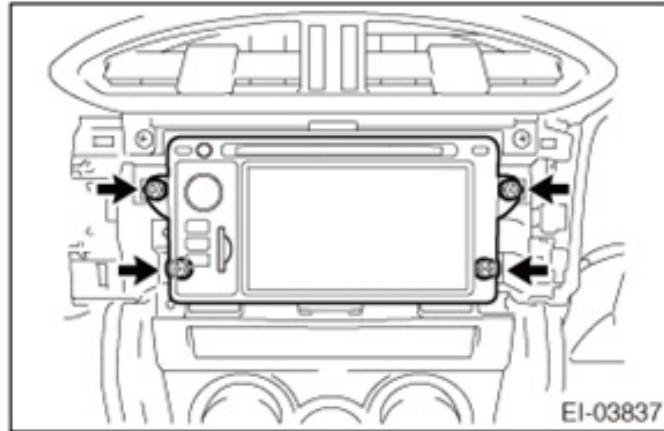

**NOTE:** Take precautions to protect the surrounding lower dash trim pieces against possible damage from contact with the navigation / audio unit's lower mounting bracket tabs using tape as shown below. Once accessible, disconnect the harness connectors from the navigation / audio unit then remove it.

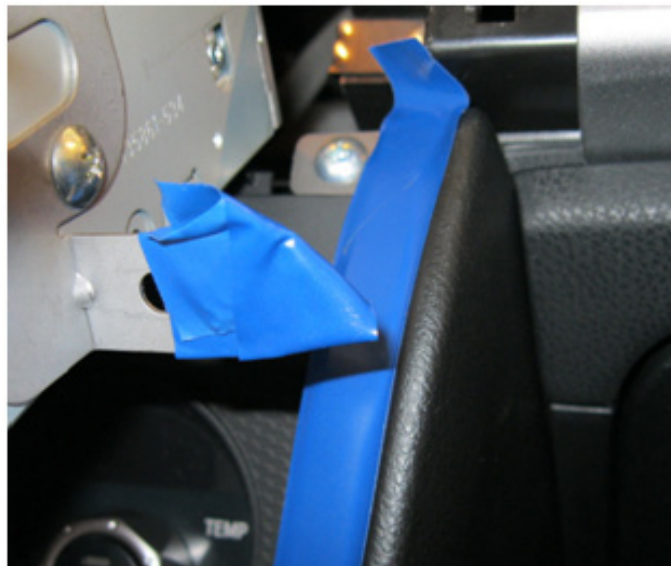

Once the navigation / audio unit is removed, the GPS antenna / mounting bracket assembly can be seen. Remove the two retaining screws and GPS antenna / mounting bracket assembly. **NOTE:** Only one of the original mounting screws will be reused.



*Continued...*

The photo below shows the revised GPS antenna / mounting bracket assembly along with an antenna lead extension harness already attached. **NOTE:** The revised GPS antenna / mounting bracket assembly you receive may have a longer 1-piece lead instead of a shorter lead with an extension pigtail as shown in the photo. Either configuration is acceptable to use for this procedure.



Install the revised GPS antenna / mounting bracket assembly. Confirm the white plastic mounting clip locks into the large oblong hole in the instrument panel support bracket properly before installing the mounting screw. **CAUTION:** Do not over-tighten the mounting screw.

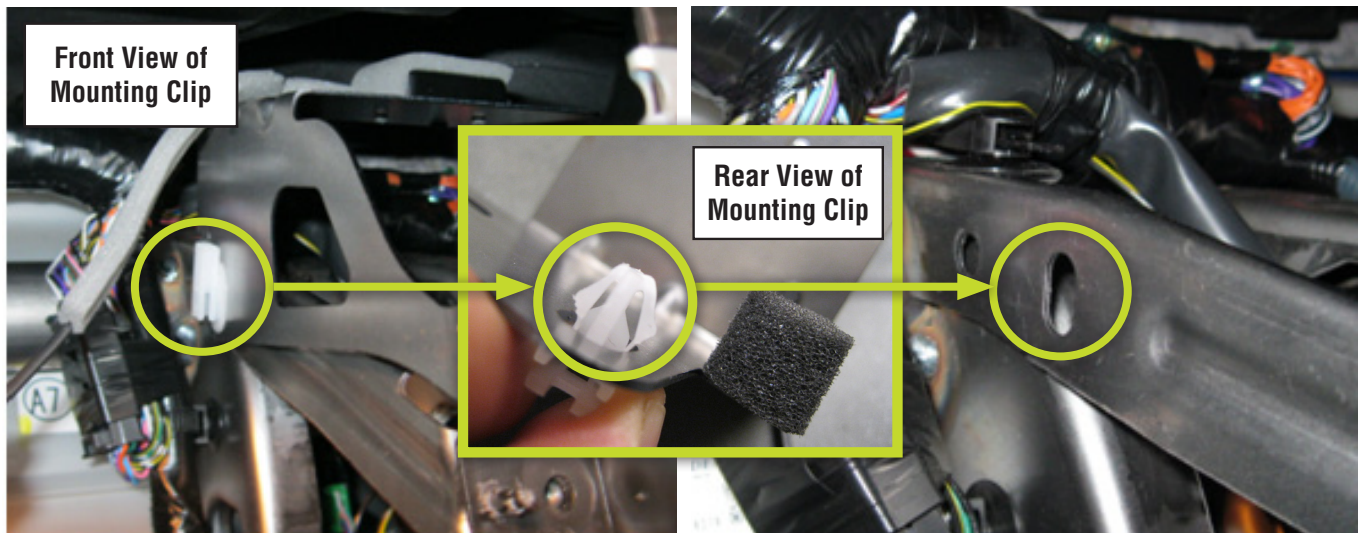

Install the antenna lead extension (if applicable) then connect it to the navigation / audio unit. Connect the other harnesses and confirm their connectors fully lock into place. When installing the navigation / audio unit, confirm the mounting tabs are fully seated on the alignment pins adjacent to the lower holes before tightening the bolts. Reinstall the navigation / audio unit trim panel.

*Continued...*

Next, the Audio / Navigation System Reprogramming Procedure provided on the following pages **MUST** be completed.

- **Step 1:** Confirm the audio / navigation unit is switched off.
  - FOR KEY-TYPE IGNITION SWITCH, Confirm the Ignition switch is “OFF”.
  - FOR PUSH-START IGNITION, confirm the Push Start Switch is “OFF”.
- **Step 2:** Remove the Back-Up fuse from the under-hood Main Fuse Box (M/B) and leave it out for at least a minute.

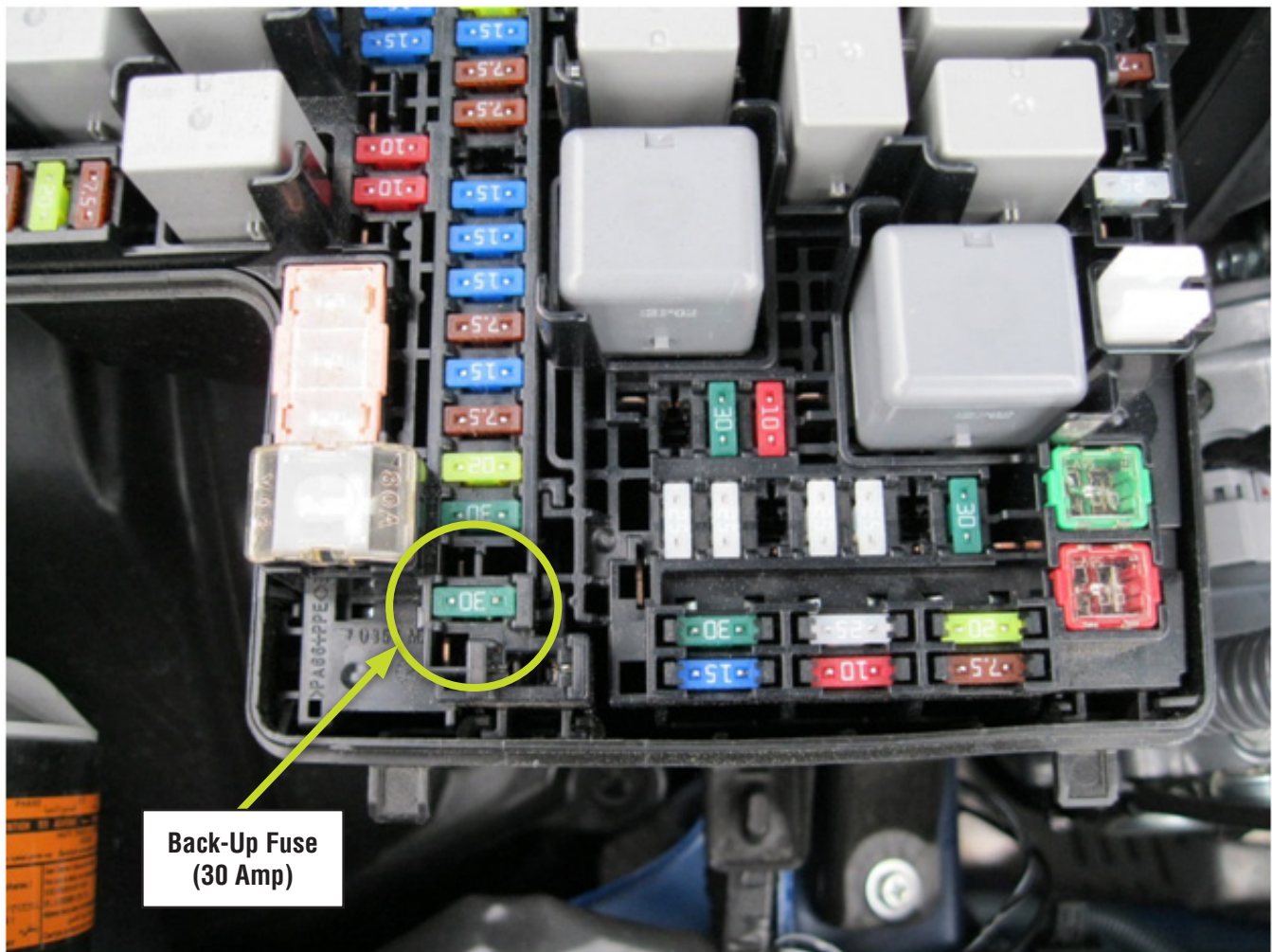

- **Step 3:** While the fuse is removed, eject the old SD card and replace it with the updated SD card then, re-install the Back-Up fuse.

*Continued...*

- **Step 4:** FOR KEY-TYPE IGNITION SWITCH, turn the ignition key to the “ACC” position. FOR PUSH-START IGNITION, turn the push start switch “ON” but **DO NOT PRESS THE BRAKE PEDAL.**

**IMPORTANT: DO NOT START THE ENGINE!!!**

- **CAUTION:** Until the programming process is completed, do not turn the ignition key or push start switch off or attempt to start the engine. Any interruption during the programming process can damage the unit’s internal navigation data in which case, the audio / navigation unit will need to be replaced. After turning the ignition key or push-start switch on, the screen will remain black for about a minute while the reprogramming process is running. Once the status/loading bars complete and the “Version Up OK” message appears, cycle the ignition key off then back on to the “ACC” position.



Black screen



- **Step 5:** When the programming process has completed, the system will display the “Start-Up” screen.



*Continued...*

- **Step 6:** After the “Start-Up” screen, the “Caution” and “End User License” screens will appear next. Press “OK” then, press “Accept” as shown below.

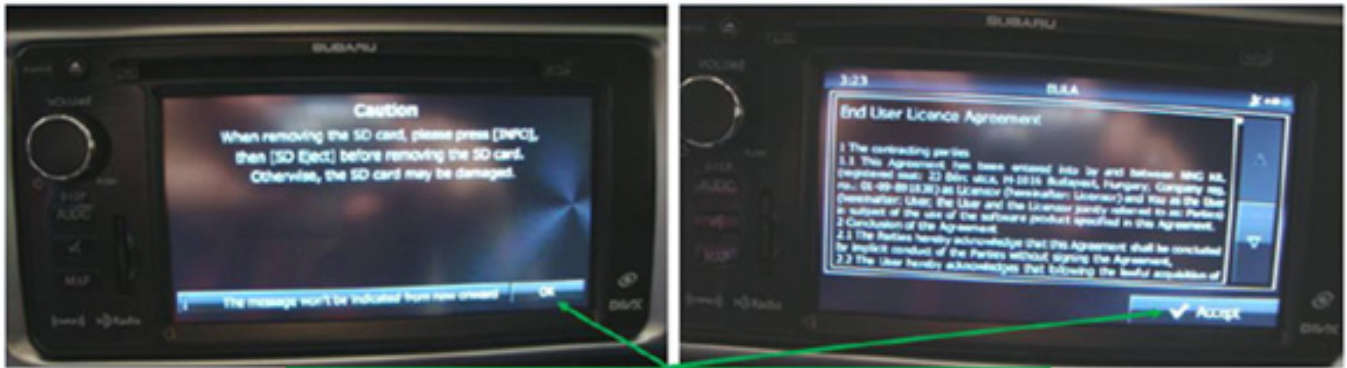

After start-up “Subaru” screen, toggle through two screens by selecting “OK” and “Accept”.

- **Step 7:** Press the “Audio” button.



*Continued...*



- **Step 8:** Press the “V” (or “down arrow”) button then the “Info” button.

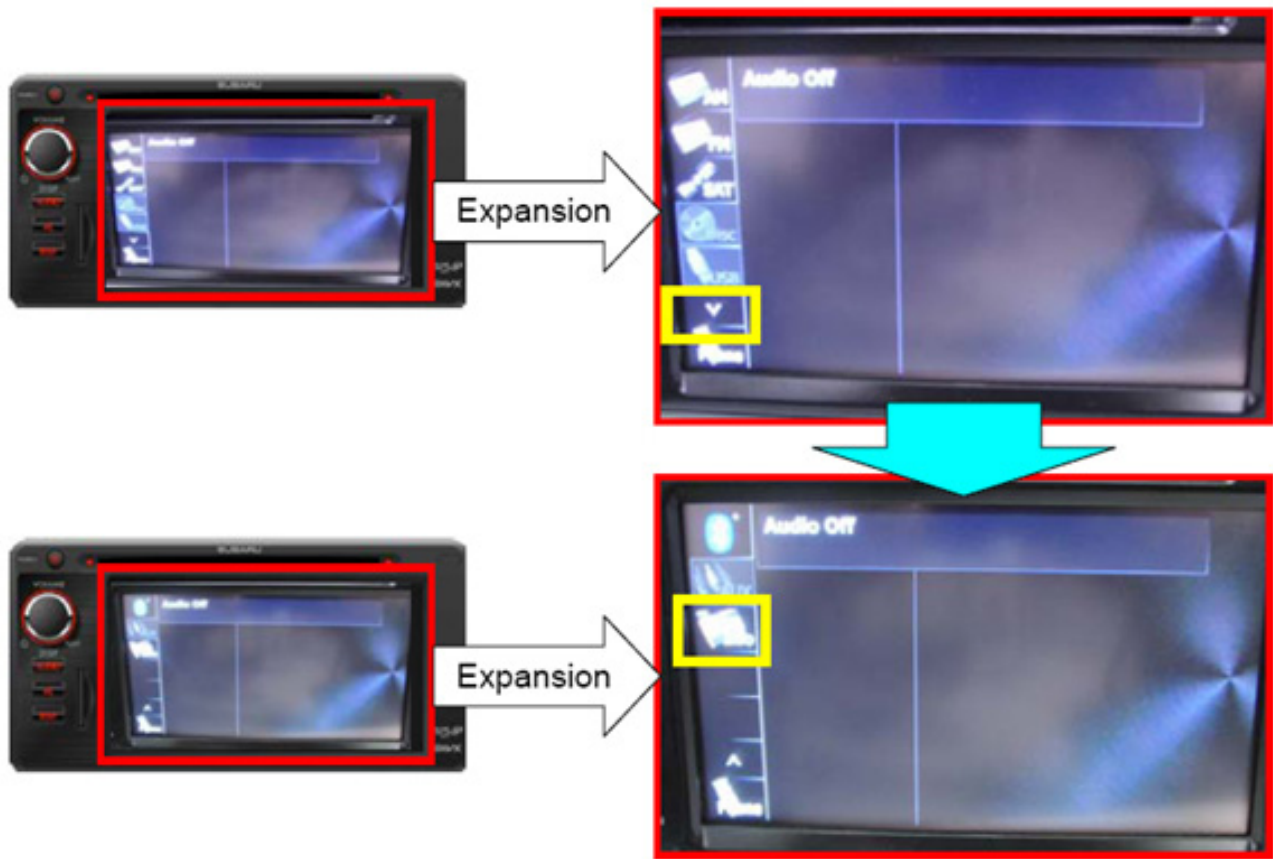

- **Step 9:** Press the "Software Version" button.

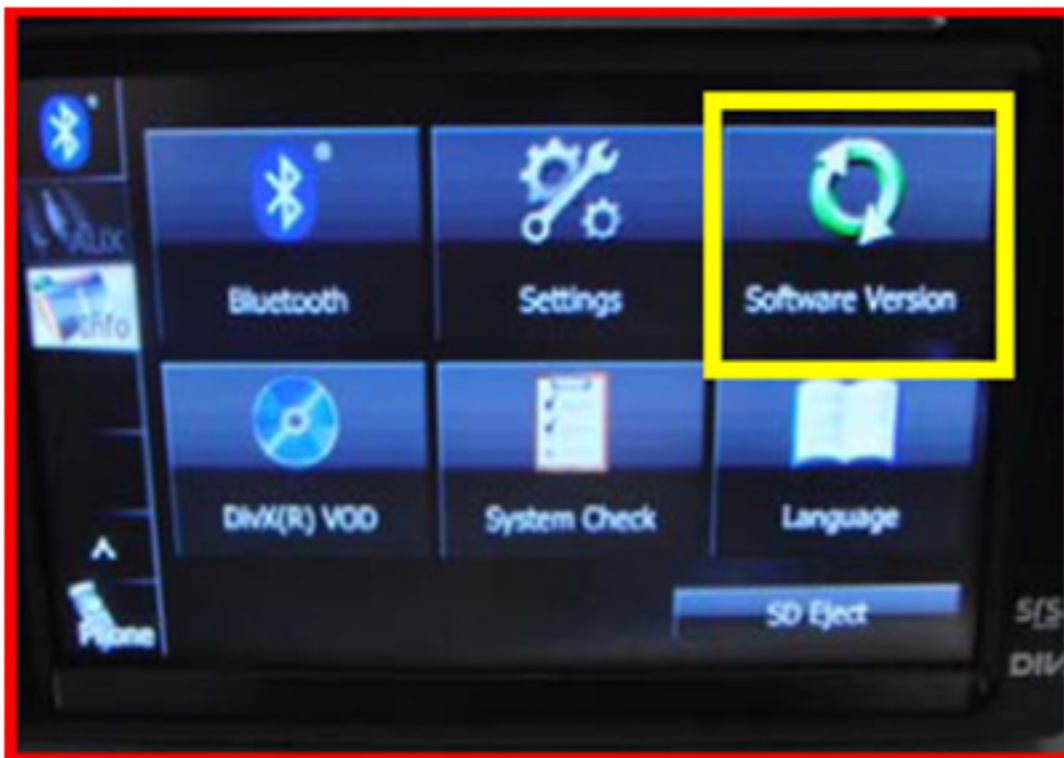

*Continued...*

- **Step 10:** Verify the Software Version has been installed.

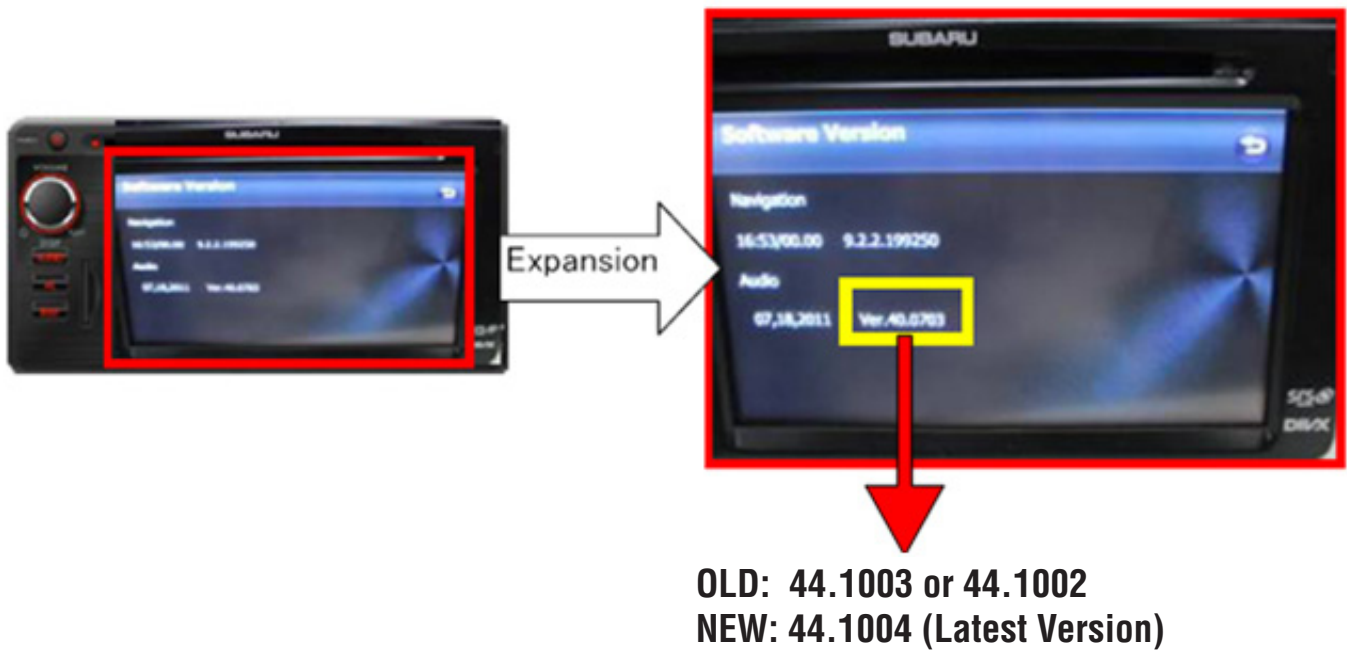

**IMPORTANT REMINDERS:** Once the reprogramming is complete, be sure to reset the customer's radio station presets and navigation system favorites to complete the repair procedure. Re-use the exchange SD card's packaging to return the original SD card to Fujitsu Ten. A padded return shipping envelope has been provided with the exchange part. Include a copy of the Fujitsu Ten Advance Exchange Fax Form in the return package. We recommend using a track-able freight carrier for the SD card's return shipment. Always attach a copy of the Exchange Fax Form and freight invoice including the tracking number to the repair order for future reference. Failure to return an exchange SD card within 30 days will result in a significant chargeback. **NOTE:** Physically damaged or corrupted SD Cards are not eligible for the exchange program. Return of a physically damaged or corrupted SD Card as part of an exchange request will result in a significant chargeback. In those cases, warranty coverage will not apply and a new SD Card must be ordered through normal parts channels for a customer pay repair.

**WARRANTY / CLAIM INFORMATION**

LABOR DESCRIPTION	LABOR OPERATION #	FAIL CODE	LABOR TIME
SD Card and GPS Antenna / Mounting Bracket Assembly R&R	A067-348	ZLO-43	0.4

The warranty/claim information listed is only applicable to BRZ and this Service Bulletin.