

ATTENTION:

- GENERAL MANAGER
- PARTS MANAGER
- CLAIMS PERSONNEL
- SERVICE MANAGER

IMPORTANT - All Service Personnel Should Read and Initial in the boxes provided, right.

© 2020 Subaru of America, Inc. All rights reserved.



QUALITY DRIVEN® SERVICE

SERVICE BULLETIN

APPLICABILITY: 2023 Subaru Vehicles

NUMBER: 15-302-22R

SUBJECT: 2023 Audio/Navigation & Power Amplifier Exchange Component Identification and Procedures

DATE: 08/23/22

REVISED: 09/27/22

INTRODUCTION

This bulletin contains illustrations of exchange components and their manufacturer as well as a description of the proper exchange procedure. The exchange program policy can also be found in Sections 8.4.9 and 11.2.10 of your Claims Policies and Procedures Manual found in Subarunet.

CONTENTS

Within the terms of the Basic New Car Warranty and the one year Replacement Parts Warranty, the Exchange Program provides for replacement of a defective unit from the manufacturer.

In the event the vehicle is “New” and “In-stock”, call the Vendor’s Service Center prior to calling Subaru Retailer Claims. A new unit will be supplied rather than a remanufactured unit. If the Vendor Service Center is unable to provide a new unit, immediately contact a Subaru Retailer Claims Specialist at 1-866-782-2782 prior to placing an order for further instructions.

The replacement of a new unit, other than new units supplied through the exchange program, requires authorization from a Subaru of America, Inc. Retailer Claims Specialist at 1-866-782-2782. An authorization code will be provided and must be included upon claim submission.

Vehicles that have been placed in demo service should use exchange units only.

CAUTION: VEHICLE SERVICING PERFORMED BY UNTRAINED PERSONS COULD RESULT IN SERIOUS INJURY TO THOSE PERSONS OR TO OTHERS.

Subaru Service Bulletins are intended for use by professional technicians ONLY. They are written to inform those technicians of conditions that may occur in some vehicles, or to provide information that could assist in the proper servicing of the vehicle. Properly trained technicians have the equipment, tools, safety instructions, and know-how to do the job correctly and safely. If a condition is described, DO NOT assume that this Service Bulletin applies to your vehicle, or that your vehicle will have that condition.

Subaru of America, Inc. is ISO 14001 Compliant

ISO 14001 is the international standard for excellence in Environmental Management Systems. Please recycle or dispose of automotive products in a manner that is friendly to our environment and in accordance with all local, state and federal laws and regulations.

Continued...

EXCHANGE PROCEDURE FOR ALL EXCHANGE COMPONENTS

- 1) The defective chassis should remain in the vehicle until the exchange unit is installed.
- 2) Contact the applicable Service Center with the following information:
 - Retailer Code
 - Retailer Name and Address
 - VIN - All 17 Characters
 - Date of Vehicle Sale
 - Vehicle Mileage
 - Caller's Name and Telephone Number
 - Claim Number
 - Face Plate ID Number (Clarion only)
 - Subaru Part Number as shown in this bulletin
 - Customer Complaint
 - Customer Last Name

At this time, the Service Center will issue an exchange number. It is required that this number be provided upon claim submission.

An exchange chassis along with an exchange form will be shipped within 72 hours. If the exchange chassis is not received within 5 days, call the Service Center. Provide the operator with the exchange number when making inquiries.

- 3) Install the exchange unit as soon as possible upon receipt. Return the defective chassis to the manufacturer within 30 days. Return freight charges may be claimed as sublet, provided the repair was performed under the terms of the Basic New Car Warranty. Copies of the freight invoice should be attached to the repair order.

If the exchange unit has not been installed or the failed chassis has not been returned within 30 days, contact the Service Center. Reference the exchange number and explain the circumstances causing the delay. An extension will be granted or the retailer will be instructed to return the exchange unit. Failure to comply will result in a "charge back" to the retailer for the cost of the exchange unit.

The retailer must return the failed component in the same approved packaging that the exchange unit arrived in. Harman exchange units arrive with a pre-paid return shipping label. A hard copy of the printout from the on-line order or the Exchange Request Form must be included in the core return package. Failure to use proper packaging could result in a "charge back" for the cost of the exchange unit and shipping.

NOTE: Activation of all subscription based services is the responsibility of the vehicle owner.

NOTE: For the "Audio Out of Warranty Exchange / Repair Program" refer to the Added Security Section 11.2.10 or Policy Adjustment Section 12.6.1 of the Claims Policies & Procedures on-line manual.

Continued...

MANUFACTURERS BY COMPONENT

Audio/Satellite

Clarion (Faurecia Clarion Electronics): Exchange order requests are to be made via the Web Portal. Clarion exchange requests are processed by United Radio. The United Radio Service Center is open from 8am – 8pm Eastern Time at **1-800-448-0944**.

Exchange units are ordered online using the link found in Subarunet/ Service Operations & Technical/ Forms/Downloads / Harman Kardon and Clarion Registration Instructions (urdealerservices.com) Ordering Instructions.

DENSO/Denso Ten Service Center is open from 7am-5pm Pacific Time at **1-800-237-5413**. The Exchange Fax Form is found on Subarunet/ Service Operations & Technical/ Forms/Downloads/ Denso Ten Online Exchange Instructions. Click on the website address <https://www.f10ncs.com>

Harman: Exchange order requests are to be made via the Web Portal

Harman exchange requests are processed by United Radio. The United Radio Service Center is open from 8am – 8pm Eastern Time at **1-800-448-0944**.

Exchange units are ordered online using the link found in Subarunet/ Service Operations & Technical/ Forms/Downloads / Harman Kardon Registration Instructions (urdealerservices.com) Ordering Instructions

Caution: If swapping an audio system for diagnostic purposes, be sure the DCM remains with the original vehicle or network communications will be severed.

Caution: SXM ESN is assigned by VIN. Moving audio units between vehicles will disrupt SXM services.

Audio/Navigation/Satellite

DENSO/Denso Ten Service Center is open from 7am-5pm Pacific Time at **1-800-237-5413**. The Exchange Fax Form is found on Subarunet/ Service Operations & Technical/ Forms/Downloads/ Denso Ten Online Exchange Instructions. Click on the website address <https://www.f10ncs.com>

Harman: Exchange order requests are to be made via the Web Portal

Harman exchange requests are processed by United Radio. The United Radio Service Center is open from 8am – 8pm Eastern Time at **1-800-448-0944**.

Exchange units are ordered online using the link found in Subarunet/ Service Operations & Technical/ Forms/Downloads / Harman Kardon Registration Instructions (urdealerservices.com) Ordering Instructions

Caution: If swapping an audio system for diagnostic purposes, be sure the DCM remains with the original vehicle or network communications will be severed.

Caution: SXM ESN is assigned by VIN. Moving audio units between vehicles will disrupt SXM services.

Continued...

Power Amplifier

Harman Kardon: Exchange order requests are to be made via the Web Portal

Harman Kardon exchange requests are processed by United Radio. The United Radio Service Center is open from 8am – 8pm Eastern Time at **1-800-448-0944**.

Exchange units are ordered online using the link found in Subarunet/ Service Operations & Technical/ Forms/Downloads / Harman Kardon Registration Instructions (urdealerservices.com) Ordering Instructions

VEHICLE APPLICATIONS – AUDIO/NAVIGATION

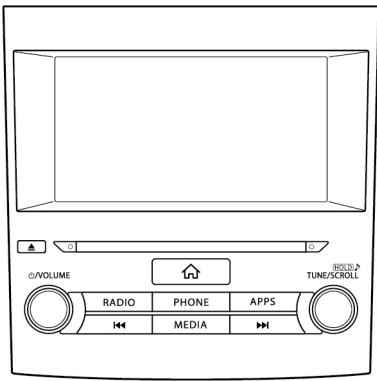
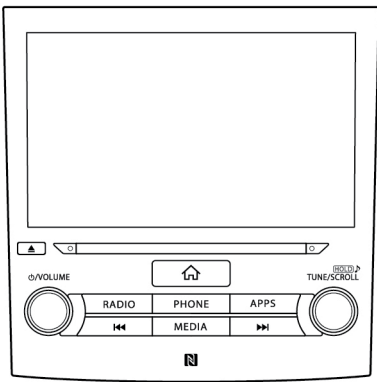
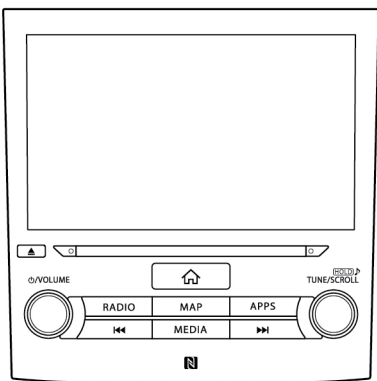
ILLUSTRATION	DESCRIPTION & APPLICABILITY	MANUFACTURER	PART NUMBER
	TBD	TBD	TBD
	TBD	TBD	TBD
	TBD	TBD	TBD

Continued...

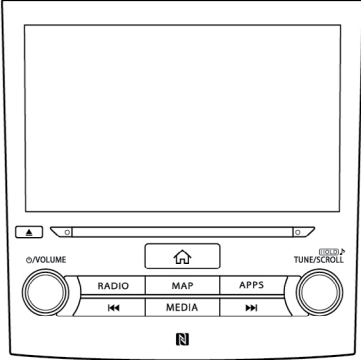
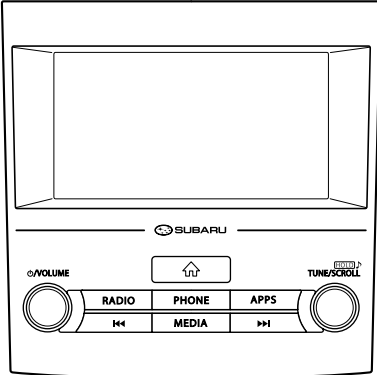
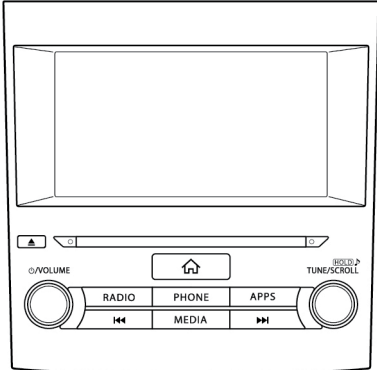
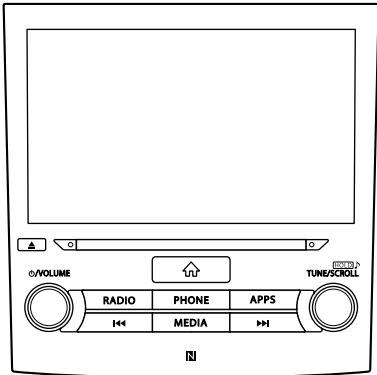
ILLUSTRATION	DESCRIPTION & APPLICABILITY	MANUFACTURER	PART NUMBER
	<p>TBD</p>	<p>TBD</p>	<p>TBD</p>
	<p>Crosstrek</p> <p>6.5-INCH Multimedia System</p> <p>Base Trims</p> <p>PRA-01 & PRB-03</p>	<p>Harman</p>	<p>86431FL610</p>
	<p>Crosstrek</p> <p>6.5-INCH Multimedia Plus System</p> <p>Premium and Sport Standard Trims</p> <p>PRC-11 PRD-13 PRD-14</p>	<p>Harman</p>	<p>86431FL670</p>
	<p>Crosstrek</p> <p>8.0-INCH Multimedia Plus System</p> <p>Sport option 22, Special Edition, Limited & Touring Trims without Navigation</p> <p>PRE-22 PRD-15 PRF-31 PRF-32 PRF-33 & PRH-01</p>	<p>Harman</p>	<p>86431FL650</p>

Continued...

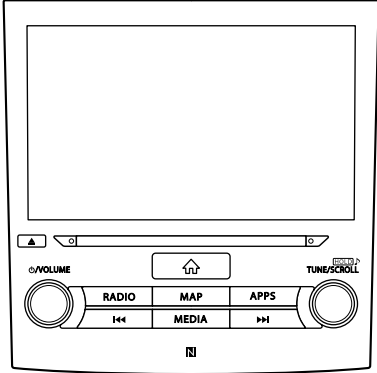
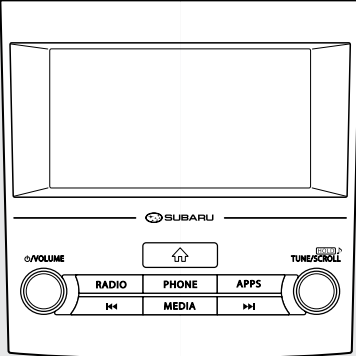
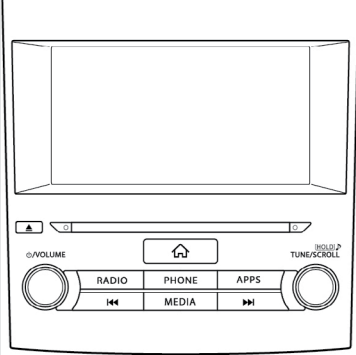
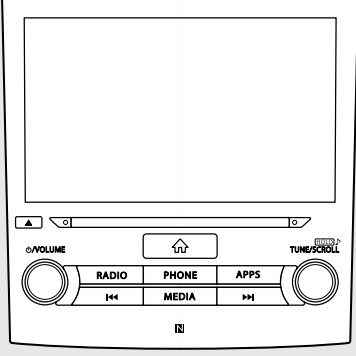
ILLUSTRATION	DESCRIPTION & APPLICABILITY	MANUFACTURER	PART NUMBER
	<p>Crosstrek</p> <p>8.0-INCH MULTIMEDIA NAVIGATION SYSTEM</p> <p>Limited and Hybrid models with Navigation</p> <p>PRF-33 & PRH-02</p>	Harman	86471FL620
	TBD	TBD	TBD
	TBD	TBD	TBD
	TBD	TBD	TBD

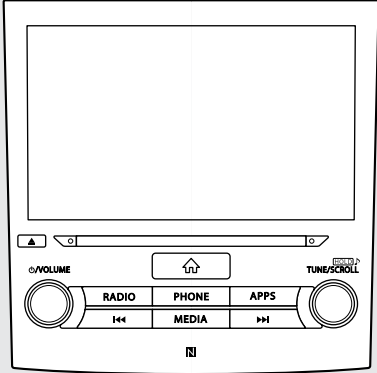
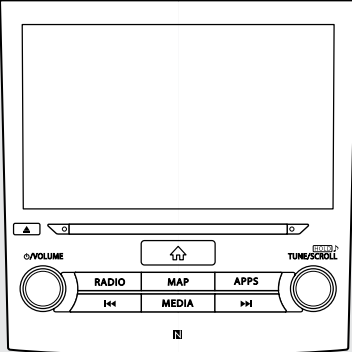
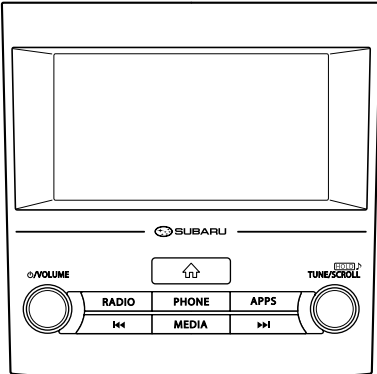
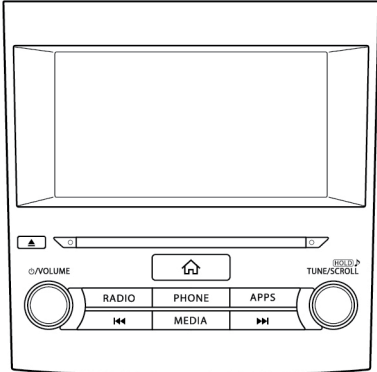

Continued...

ILLUSTRATION	DESCRIPTION & APPLICABILITY	MANUFACTURER	PART NUMBER
	TBD	TBD	TBD
	TBD	TBD	TBD
	<p>Impreza</p> <p>6.5 Inch Multimedia System</p> <p>Base Trims</p> <p>PJA-01 PJB-03 PLA-01 PLB-03</p>	Harman	86431FL61A
	<p>Impreza</p> <p>6.5 Inch Multimedia Plus System</p> <p>Premium Trims</p> <p>PJD-11 PJD-14 PLD-11 PLD-14</p>	Harman	86431FL67A

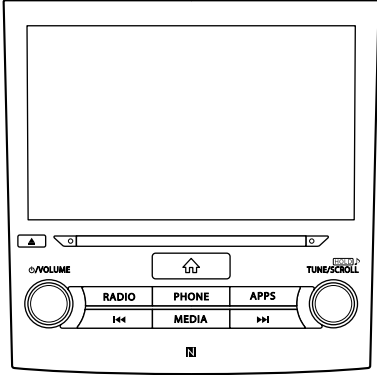
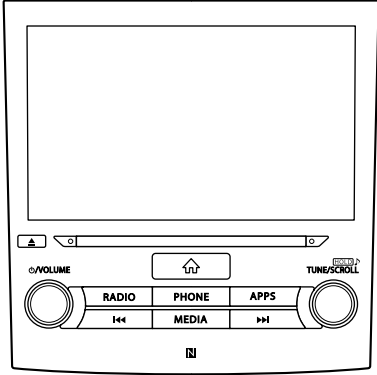
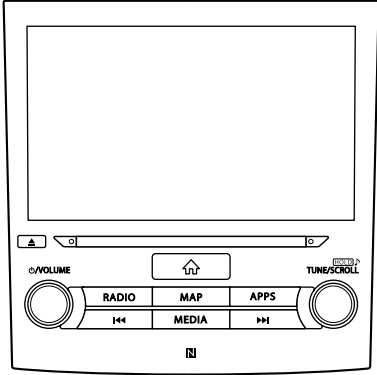
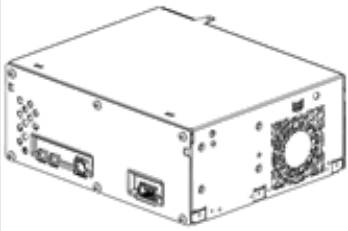
Continued...

ILLUSTRATION	DESCRIPTION & APPLICABILITY	MANUFACTURER	PART NUMBER
	<p>Impreza</p> <p>8.0 Inch Multimedia Plus System</p> <p>Standard Sport Trims Standard Limited Trims</p> <p>PJF-21 PLE-21 PLF-21 PLG-31</p>	Harman	86431FL65A
	<p>Impreza</p> <p>8.0 Inch Multimedia Plus System</p> <p>Sport Trim w/ HK Amplifier</p> <p>PJF-23 PLF-23</p>	Harman	86431FL66A
	<p>Impreza</p> <p>8.0 Inch Multimedia Navigation System</p> <p>Limited Trim w/ Navigation</p> <p>PLG-35</p>	Harman	86471FL62A
	<p>Legacy & Outback</p> <p>Cockpit Control Unit Assembly (CHASSIS)</p> <p>Base Trims</p> <p>PAB-02 PDB-01</p>	DENSO	86201AN62A

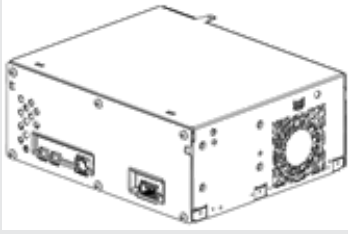
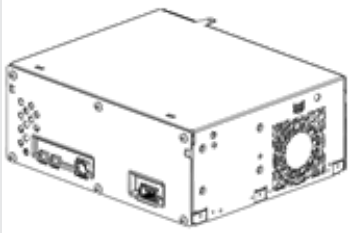
Continued...

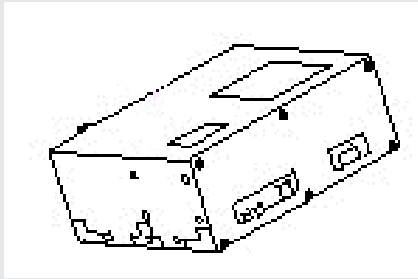
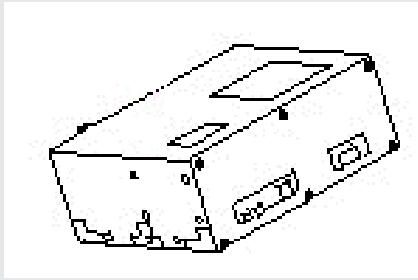
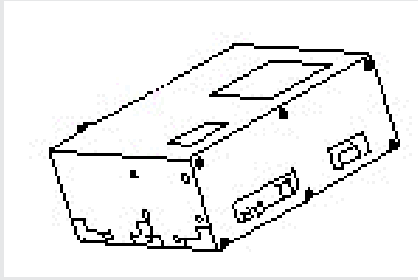
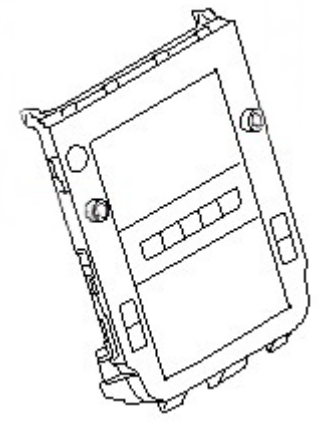
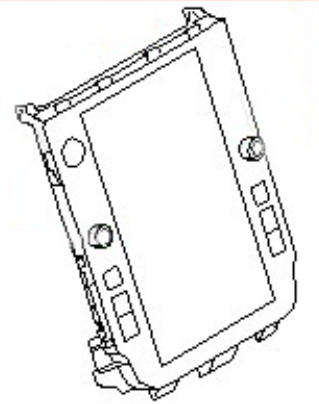

ILLUSTRATION	DESCRIPTION & APPLICABILITY	MANUFACTURER	PART NUMBER
	<p>Legacy & Outback Cockpit Control Unit Assembly (CHASSIS)</p> <p>Premium, Onyx, Limited & Wilderness Trims - Non-Navigation</p> <p>PAD-11 PAD-13 PDD-11 PDD-13 PDE-21 PDF-31 PAF-31</p>	DENSO	86201AN68A
	<p>Legacy & Outback Cockpit Control Unit Assembly (CHASSIS)</p> <p>Premium, Sport, Wilderness, Onyx, Onyx XT Limited, Limited XT, Touring & Touring XT Trims With Navigation</p> <p>PAD-15 PDD-15 PAG-21 PDE-22 PDI-22 PAL-41 PDH-22 PDJ-32 PDL-41 PAF-34 PDF-34 PDG-41</p>	DENSO	86271AN63A
	<p>Solterra</p> <p>Subaru Multimedia 8 Inch Navigation System</p> <p>Premium Trims PED-11-C</p>	DENSO TEN	8614042G30
	<p>Solterra</p> <p>Subaru Multimedia 12.3 Inch Navigation System</p> <p>Limited & Touring Trims PEG-31-C & PEJ-41-C</p>	DENSO TEN	8610042530

Continued...

ILLUSTRATION	DESCRIPTION & APPLICABILITY	MANUFACTURER	PART NUMBER
	TBD	TBD	TBD
	TBD	TBD	TBD
	TBD	TBD	TBD

<p style="text-align: center;">ATTENTION! PERFORM SUFFICIENT DIAGNOSIS FOLLOWING PROCEDURES TO VALIDATE THE EXCHANGE ORDER</p>			
	<p style="text-align: center;">Legacy & Outback</p> <p style="text-align: center;">Dual 7 Inch Center Information Display</p> <p style="text-align: center;">Base Models PAB-02 PDB-01</p>	DENSO	86213AN64A

Continued...

ILLUSTRATION	DESCRIPTION & APPLICABILITY	MANUFACTURER	PART NUMBER
	<p>Legacy & Outback</p> <p>11.6 Inch Center Information Display</p> <p>All Trims Except Base</p>	DENSO	86213AN67A
<p>ATTENTION!</p> <p>PERFORM SUFFICIENT DIAGNOSIS FOLLOWING PROCEDURES TO VALIDATE THE EXCHANGE ORDER</p>			
	TBD	TBD	TBD
	TBD	TBD	TBD
	<p>BRZ</p> <p>Cockpit Control Unit</p> <p>All Trims</p>	DENSO	86201CC610

Continued...

ILLUSTRATION	DESCRIPTION & APPLICABILITY	MANUFACTURER	PART NUMBER
ATTENTION! PERFORM SUFFICIENT DIAGNOSIS FOLLOWING PROCEDURES TO VALIDATE THE EXCHANGE ORDER			
	BRZ 8 Inch Center Information Display All Trims	DENSO	86213CC200

POWER AMPLIFIER EXCHANGE NUMBER EXAMPLE:

Harman Kardon (United Radio) Exchange Number Example..Orders placed prior to 7/9/19
R.A. Number 9MW741 (1 digit 2 letters 3 digits)

Harman Kardon (United Radio) Exchange Number Example...Orders placed after 7/9/19
MCO # 1234567890 (Ten Digits – All Numbers)

POWER AMPLIFIER SERVICE CENTER CONTACT INFORMATION AND HOURS OF OPERATION



Harmon Kardon (United Radio) **1-800-448-0944** 8am-8pm Eastern Time

Harman Kardon exchange requests are processed by United Radio.
Exchange units are ordered online using the link found in Subarunet/ Service Operations & Technical/ Forms/Downloads / Harman Kardon Registration Instructions (urdealerservices.com)
Ordering Instructions

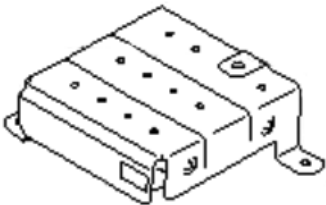
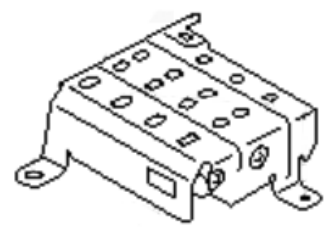
VEHICLE APPLICATIONS – POWER AMPLIFIER

ILLUSTRATION	DESCRIPTION	MANUFACTURER	PART NUMBER
	Ascent	TBD	TBD
	Crosstrek Power Amplifier Assy Limited and Hybrid Models with Navigation	Harman	86221FL015

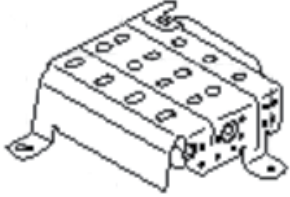
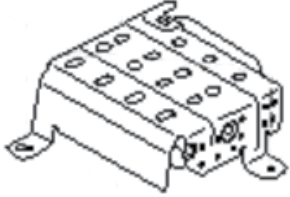
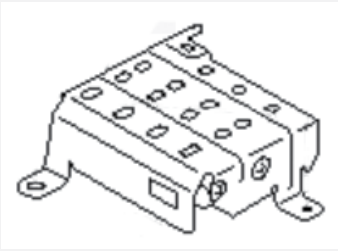
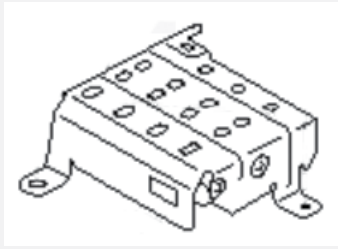
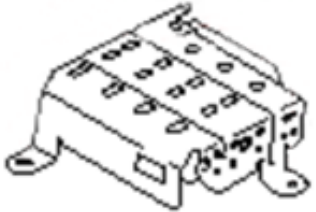
Continued...

ILLUSTRATION	DESCRIPTION	MANUFACTURER	PART NUMBER
	<p>Forester</p>	<p>TBD</p>	<p>TBD</p>
	<p>Forester</p>	<p>TBD</p>	<p>TBD</p>
	<p>Impreza Power Amplifier Assy Sport Trim PJF-23 & PLF-23</p>	<p>Harman</p>	<p>86221FL00F</p>
	<p>Impreza Power Amplifier Assy Limited Trim PLG-35</p>	<p>Harman</p>	<p>86221FL01F</p>
	<p>Legacy Outback Power Amplifier Assy Limited & Touring XT Legacy Trims Touring, Limited XT & Touring XT Outback Trims PAF-31 PAF-34 PAL-41 PDG-41 PDJ-32 PDL-41</p>	<p>Harman</p>	<p>86221AN11B</p>
	<p>Solterra Power Amplifier Assy Limited & Touring Models</p>	<p>Harman</p>	<p>8628042090</p>

Continued...

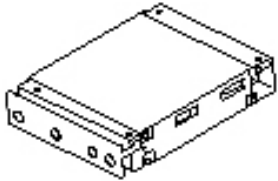
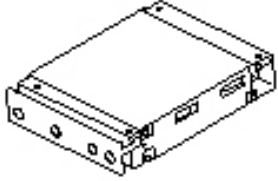
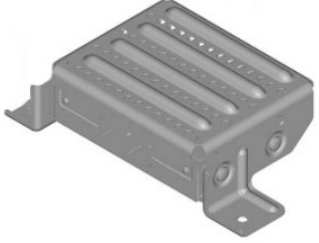
ILLUSTRATION	DESCRIPTION	MANUFACTURER	PART NUMBER
	WRX	TBD	TBD
	WRX	TBD	TBD
	BRZ Power Amplifier Assy Limited Trim PZE-11 PZF-13	Pioneer	86221CC100

SATELLITE ACTIVATION INSTRUCTIONS

CLARION & DENSO

If you need to perform a warranty exchange on any radio that is factory equipped with a Clarion or DENSO satellite radio, please follow the instructions below. Going through the process will ensure that any fee for the new radio is waived and will ensure your customer continues to receive their satellite radio programming without any interruption of service.

- Step 1.** Call Sirius XM Retailer Support at 1-800-852-9696 and let the agent know you are doing a warranty exchange on a Subaru vehicle.
- Step 2.** Provide the agent with the old Radio ID and ask them to transfer the service on this radio to the new Radio ID. Confirm with the agent that the old Radio ID has been deactivated. *(To find the Radio ID, go into satellite radio mode and tune to channel "0", the Radio ID will display for you, it will be 8 alpha-numeric characters long).*
- Step 3.** Confirm which services you are transferring e.g. Audio only or Audio and Traffic.
- Step 4.** Ask the SXM Dealer support agent to send an activation signal to the new radio and confirm the radio is working. Retailers can also perform a signal refresh if necessary by entering in the Radio ID into the following URL, www.siriusxm.com/oemrefresh

NOTE: If the unit is inoperative, call Sirius XM for assistance in identifying the existing radio ID number.

Continued...

HARMAN ONLY

All exchange units equipped with a Harman satellite radio will be reactivated by United Radio prior to being shipped to the Retailer.

Caution: If swapping an audio system for diagnostic purposes, be sure the DCM remains with the original vehicle or network communications will be severed.

Caution: SXM ESN is assigned by VIN. Moving audio units between vehicles will disrupt SXM services.

EXCHANGE NUMBER EXAMPLES AND SERVICE CENTER PHONE NUMBERS FOR AUDIO/NAVIGATION

The Audio Exchange Program provides for replacement of a defective Audio/Navigation unit with an exchange unit from the manufacturer.

The applicable Service Center for each manufacturer should be contacted and at that time the Service Center will issue an exchange number. It is required that this number be provided upon claim submission.

Below are examples of the audio exchange numbers and the telephone number for the Service Center for each manufacturer.

AUDIO EXCHANGE NUMBER EXAMPLES

Clarion Exchange Number Example – Orders placed prior to 12/23/19 (ERS#) 0000000001

Clarion Exchange Number Example – Orders placed as of 12/23/19 MCO # 1234567890 (Ten digits – all numbers)

Harman (United Radio) Exchange Number Example..Orders placed prior to 7/9/19
R.A. Number 9MW741 (1 digit 2 letters 3 digits)

Harman (United Radio) Exchange Number Example...Orders placed after 7/9/19
MCO # 1234567890 (Ten Digits – All Numbers)

AUDIO SERVICE CENTER PHONE NUMBERS AND HOURS OF OPERATION.

Clarion	1-800-448-0944	8am-8pm Eastern Time
DENSO	1-800-237-5413	7am-5pm Pacific Time
Harman (United Radio)	1-800-448-0944	8am-8pm Eastern Time

PACKING SLIP RO NUMBER REQUIREMENT – 2020 LEGACY & OUTBACK MODELS

DENSO ONLY

Continued...

Effective November 1, 2019; all DENSO Cockpit Control Units, Audio and Audio w/Navigation Multimedia Infotainment Systems will require an additional entry of the RO* character string (see image below) from the DENSO/Denso Ten exchange unit “Packing Slip” included with the delivery of every DENSO exchange unit shipped to the Retailer. The RO field is located between the Order Date and Complaint on the Packing Slip.

* Please do not confuse this with the Retailer repair order number.

The RO number on the DENSO/Denso Ten Packing Slip is a required entry for the Comments Field for a claim submission for an audio exchange. This is in addition to the existing Claim Order/ Audio Exchange Number entry in the Misc. Detail field. BOTH entries will now be required.

An example of the RO number on the DENSO/Denso Ten Packing Slip is show below.

DENSO TEN		Packing Slip		Date 08-OCT-2019 12:41		
		461473		Page 1 of 1		
Ship from LAO - Los Angeles Organization 20100 Western Avenue Torrance, CA 90501, United States		Ship to		Repair Type Denso Ex		
Customer Name		Attn		VIN		
Claim Order 9YB854067						
Delivery Name 21579156		Pick up Date 08-OCT-19				
Order Date 07-OCT-19		Ship Method FEDEX-OVERNIGHT				
RO F10S6BAC17595C		PO				
Complaint CUSTOMER STATES THE SCREEN FROZE UP						
854067		S070370BILLTO				
Model	Customer Item	Description	Order Line	UOM	Quantity Requested	Quantity Shipped
TN9746879-300	86271-AN60A	CAR NAVI I/VI OR HC CCU US HIGH	1.1	Ea	1	1
***** IMPORTANT, PLEASE READ! *****						
1. Please inspect your unit upon receiving. Denso Ten will not accept any freight-damaged-claims after 15 days from ship date. 2. Please confirm that the model received is correct. If any discrepancy, DO NOT INSTALL unit. Call Denso Ten at 800-237-5413 3. To the extent permitted by applicable law, Denso Ten will retain any parts replaced during repair including parts that are unsafe, toxic or require special handling, and the replacement part becomes the customer's property. If applicable law requires Denso Ten to return a replaced part to the customer with the exception of parts that are rebuilt on an exchange basis, the customer agrees to pay Denso Ten the additional cost of the replacement parts including shipping.						

AUDIO/NAVIGATION & POWER AMPLIFIER COMPONENT OUT-OF-WARRANTY EXCHANGE / REPAIR PROGRAM

Vehicles outside the terms of the New Car Basic or Parts Warranties may utilize the Audio Exchange/Repair Program which is to be referenced as an “Out-of Warranty Exchange Program”. Subaru Added Security Gold Plus customers are entitled to this “out-of-warranty” exchange program when the failure meets the terms of the Agreement.

The out-of-warranty exchange program is intended to enhance customer satisfaction by providing a prompt exchange with a quality factory serviced audio unit which has been refurbished to the highest standards.

Continued...

All out-of-warranty orders will be subject to Supplier availability. In case of low stock, “in-warranty” orders will take priority over “out-of-warranty” orders. In general, this program is for internal failures and does not include exchanges for damage (spilled liquid, scratches, etc.) Speak with the Audio/Navi. Supplier to determine exchange eligibility.

Out of Warranty Exchange Program procedures are outlined below. Please have the following information available when contacting the Service Center.

Retailer Code
Retailer Name and Address
VIN – All 17 Characters
Date of Vehicle Sale
Vehicle Mileage
Caller’s Name and Telephone Number
Claim Number
Face Plate ID Number (Clarion and Fujitsu Ten only)
Subaru Part Number
Customer Complaint
Customer Last Name

Clarion (United Radio) 1-800-448-0944

- Clarion exchange requests are processed by United Radio.
- Exchange cores will be shipped UPS Ground or 2nd Day Air within 72 hrs.
- Clarion offers a 1 yr. manufacturer’s warranty on these exchange units
- Clarion will invoice the retailer for the cost of the exchange unit
- Shipping charges for return of the core is the responsibility of the retailer
- Cores must be returned to Clarion (United Radio) within 30 days
- Delinquent cores will be invoiced to SOA who in turn will debit the retailer
- There will be a restocking fee of 20% for all unused returned cores. Retailers will be invoiced by Clarion (United Radio) and are to make payment directly to Clarion (United Radio) for this fee

DENSO/Denso Ten 1-800-237-5413

- Exchange cores will be shipped UPS Ground or 2nd Day Air within 72 hrs.
- DENSO/Denso Ten offers a 1 yr. manufacturer’s warranty on these exchange units
- DENSO/Denso Ten will invoice the retailer for the cost of the exchange unit
- Shipping charges for return of the core is the responsibility of the retailer
- Cores must be returned to DENSO/Denso Ten within 30 days
- Delinquent cores will be invoiced to SOA who in turn will debit the retailer
- There will be a restocking fee of 20% for all unused returned cores.

Retailers will be invoiced by DENSO/Denso Ten and are to make payment directly to DENSO/Denso Ten for this fee.

Continued...

Harman Kardon (United Radio) 1-800-448-0944

- Harman Kardon exchange requests are processed by United Radio.
- Exchange cores will be shipped UPS Ground or 2nd Day Air within 72 hrs.
- Harman Kardon offers a 1 yr. manufacturer's warranty on these exchange units
- Harman Kardon will invoice the retailer for the cost of the exchange unit
- Shipping charges for return of the core is the responsibility of the retailer
- Cores must be returned to Harman Kardon (United Radio) within 30 days
- Delinquent cores will be invoiced to SOA who in turn will debit the retailer
- There will be a restocking fee of 20% for all unused returned cores. Retailers will be invoiced by Harman Kardon (United Radio) and are to make payment directly to Harman Kardon (United Radio) for this fee.