

February 18, 2021

Version 4

2018-21 Odyssey: Popping or Crackling from the Speakers; No Sound from the Audio System; Network Loss Message and/or Display Issues

Supersedes 20-049, dated October 12, 2020, to revise the information highlighted in **yellow**.

AFFECTED VEHICLES

Year	Model	Trim Level	VIN Range
2018-21	Odyssey	ALL except LX	ALL

REVISION SUMMARY

- Under AFFECTED VEHICLES – The population of 2018-20 models were updated and for those that are out of warranty, please refer to service bulletin, “21-013 Warranty Extension: 2018-20 Odyssey MOST Bus Network Connectors”
- Under REPAIR PROCEDURE steps have been updated.
- Under WARRANTY INFORMATION the operation code was updated.

SYMPTOM

There is a popping or crackling from the speakers or no sound from the audio system. You may also see a **Network Loss** message and/or display issues.

POSSIBLE CAUSE

There is a loose connection in the MOST bus network.

CORRECTIVE ACTION

Install the FAKRA connector set and the MOST service cords.

PARTS INFORMATION

Part Name	Part Number	Quantity
FAKRA Service Housing	39817-TJB-AC0	3

TOOL INFORMATION

Tool Name	Tool Number	Quantity
Straight FAKRA Puller	07AAC-THRA200	1
Cargo Cap Screw Socket	07AAA-SEPA100	1

CUSTOMER INFORMATION: The information in this bulletin is intended for use only by skilled technicians who have the proper tools, equipment, and training to correctly and safely maintain your vehicle. These procedures should not be attempted by “do-it-yourselfers,” and you should not assume this bulletin applies to your vehicle, or that your vehicle has the condition described. To determine whether this information applies, contact an authorized Honda automobile dealer.

WARRANTY CLAIM INFORMATION

The normal warranty applies.

Operation Number	Description	Flat Rate Time	Defect Code	Symptom Code	Template ID	Failed Part Number
0101Q5	Access the gauge control module, infotainment control unit, and stereo amplifier or tuner-amplifier unit, then replace the affected FAKRA connectors (includes test-drive).	2.0 hr	03214	03217	A20049A	39540-THR-A73

Skill Level: Repair Technician

INSPECTION PROCEDURE

1. Turn the ignition to ON.
2. Press and hold the VOL/Power AUDIO knob, **Day/Night** icon, and **HOME** icon at the same time. Then, release them when you see the **Dealer Diagnostics** screen.



3. Select **DETAIL INFORMATION & SETTING**.

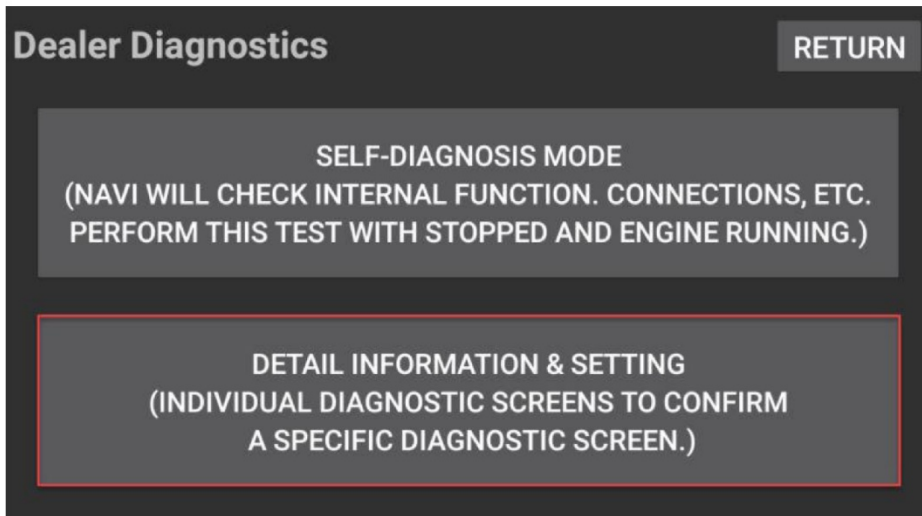

4. Scroll down the menu, and select **SHUTDOWN REASON**.

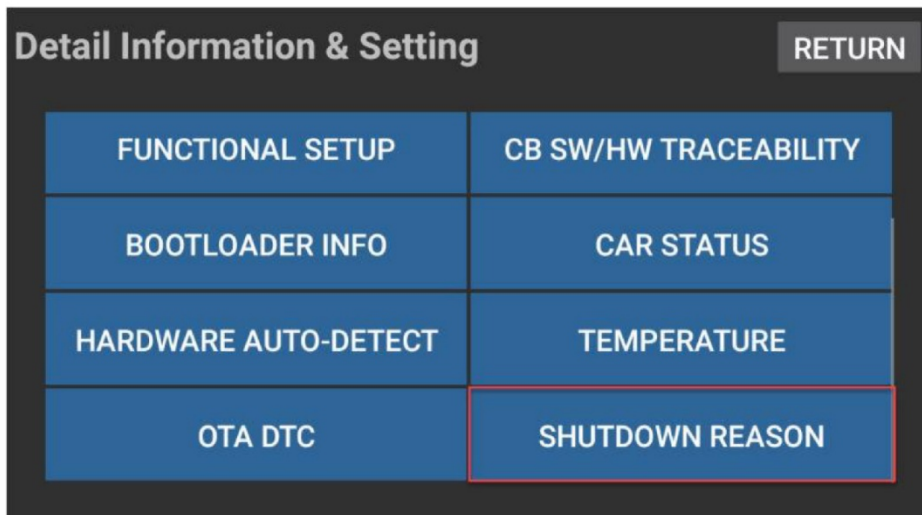

In this example, the cause of the failure can be identified as **Meter:SUDDEN_SIGNAL_OFF**.



Write down any failures; they will be collected on the warranty claim. Then, clear the data.

REPAIR PROCEDURE

1. Remove the lower vent covers.



LOWER VENT COVERS

2. Loosen the upper column cover.



UPPER
COLUMN
COVER

3. Disengage the clips around the meter bezel. Then, remove it with the upper column cover as one piece.



METER
BEZEL

4. Remove the three screws holding the gauge control module.



5. Turn the gauge control module to access the rear connectors. Then, using the straight FAKRA tool, disconnect the red and green FAKRA connectors, and remove them from the gauge control module. **Do not pull on the units or MOST feeders while the FAKRA connectors are connected to help prevent communication issues.**

NOTE: For more information on using the FAKRA tools, see the job aid, *Using the MOST Connector Tools*.



6. Remove the cover above the center display unit.

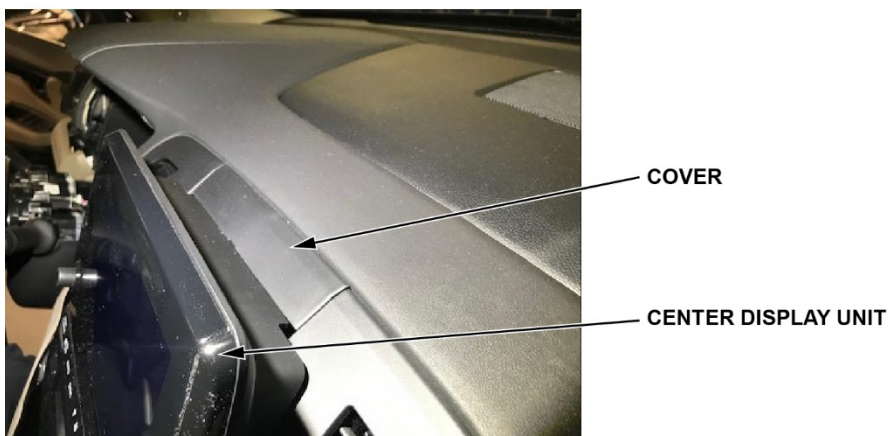

7. Remove the center dash trim.



CENTER
DASH TRIM

8. Remove the two screws.



SCREWS

9. Remove the side cover.



SIDE
COVER

10. Remove the two screws.



11. Remove the lower dash panel.



12. Remove the passenger lower panel.



13. Remove the driver lower console panel and the passenger lower console panel.



**DRIVER LOWER
CONSOLE PANEL**



**PASSENGER LOWER
CONSOLE PANEL**

14. Pull back the cover, and remove the bolt.



BOLT

15. Remove the rubber liner, and pull back the lower console cover.



**RUBBER
LINER**

16. Remove the two screws from the dashboard center pocket, then pull back the panel.



SCREWS



DASHBOARD CENTER POCKET

17. Remove the two upper screws, and loosen the two lower screws.

NOTE: Some models will have a CD player, DVD player or center pocket.

SCREWS
Remove.



SCREWS
Loosen.

18. Remove the DVD player, CD player or center pocket to gain access to the two 8 mm bolts holding the infotainment unit.



**DVD PLAYER,
CD PLAYER or
CENTER POCKET**

19. While looking upward from underneath where the DVD player, CD player, or center pocket was removed, loosen the two 8 mm bolts holding the infotainment unit, then remove the unit.

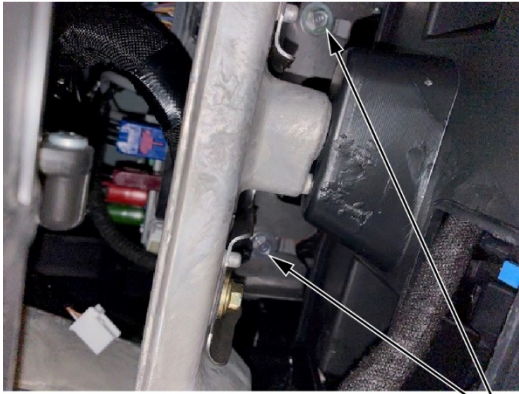

BOLTS

20. In the rear cargo area, remove the rear trim panel.

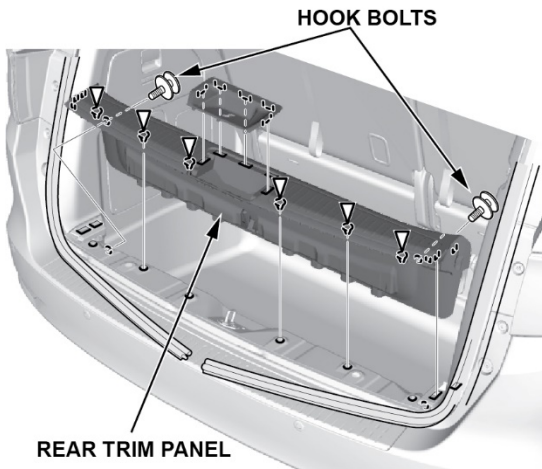

If necessary, use Special Tool 07AAA-SEPA100 to loosen the hook bolts.



21. On the right rear quarter panel, remove the hook bolts. If needed, use Cargo Cap Screw Socket (T/N 07AAA-SEPA100) to loosen the bolts.

22. Remove the covers then remove the two screws from the passenger side inner rear quarter panel.



SCREWS

**PASSENGER SIDE
INNER REAR
QUARTER PANEL**

23. Remove the lower passenger sliding door trim.



**LOWER PASSENGER
SLIDING DOOR TRIM**

24. Remove the right quarter inner panel, then disconnect the connectors.

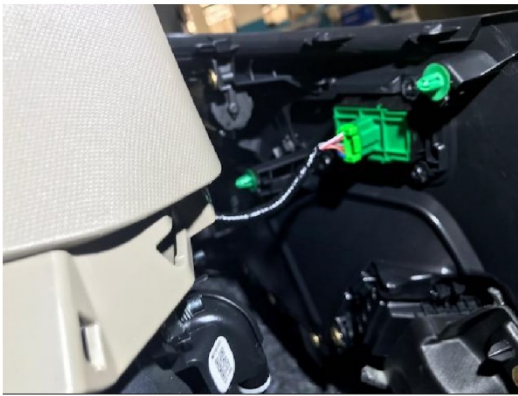

RIGHT QUARTER INNER PANEL

25. Disconnect the red and green FAKRA connectors from the stereo amplifier (Elite) or tuner-amplifier unit (EX, EX-L, Touring), gauge control module, and infotainment unit using the straight FAKRA puller. **Do not pull on the units or MOST feeders while the FAKRA connectors are connected to help prevent communication issues.**

NOTE: Disassemble the connectors one at a time to avoid swapping the green and red wires.



STEREO AMPLIFIER OR
TUNER-AMPLIFIER



GAUGE
CONTROL
MODULE

INFOTAINMENT
UNIT



26. Using a small screwdriver, remove the secondary lock, then break off the tab as shown. Then, discard the housing and lock.

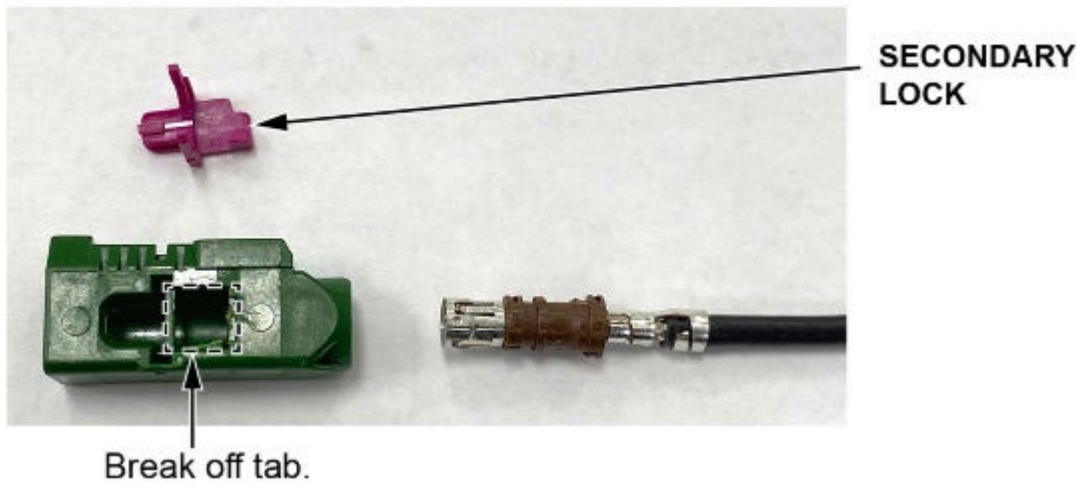

27. Pull and twist the housing counterclockwise to remove it from the wire.
28. Select the correct color FAKRA housing, then slide the new terminal onto the wire until it clicks into place.

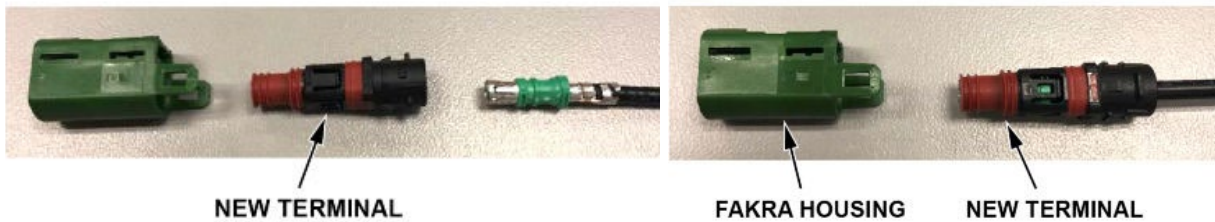

29. Line up the locking tabs on the FAKRA housing with the new terminal, then push the terminal into the housing until it clicks into place.



30. Repeat steps 26 thru 29 for the other connectors. Then, install the FAKRA connectors to the gauge control module, infotainment unit, and stereo amplifier or tuner-amplifier unit.

31. Install all of the removed parts in the reverse order. When installing units, make sure the harness is routed correctly. A mis-routed harness can put pressure on the wires and connectors causing connection issues. Do not pull on the units or MOST feeders while the FAKRA connectors are connected to help prevent communication issues.

BEFORE



AFTER

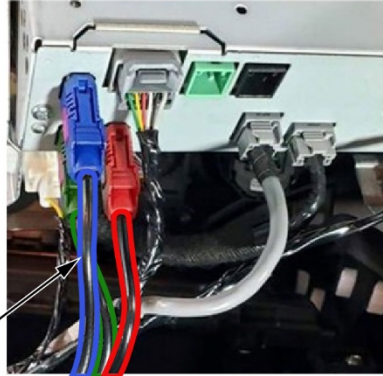

**HARNESS
Reroute.**

32. Test-drive the vehicle to confirm the repair.

END