



Service Bulletin

File in Section: -

Bulletin No.: PI0834

Date: October, 2012

PRELIMINARY INFORMATION

Subject: New Model Features and Information for Bi-Fuel Gasoline and Compressed Natural Gas (CNG) Pickup Trucks (U.S. and Canada Only)

Models: 2013 Chevrolet Silverado 2500HD
2013 GMC Sierra 2500HD
Equipped with Vortec 6.0L V-8 RPO LC8 Engine
Equipped with Extended Cab Only
Equipped with Standard or Long Box
Equipped with Two-Wheel or Four-Wheel Drive

Attention: This vehicle operates using gasoline or compressed natural gas (CNG). When servicing these vehicles, please consult all applicable local, state/provincial and federal regulations relative to technician licensing, tool and workplace requirements.

Introduction



2914906

The purpose of this bulletin is to introduce the new 2013 Chevrolet Silverado and GMC Sierra Bi-Fuel gasoline and compressed natural gas (CNG) pickup trucks.

The following information will familiarize dealership service personnel with the vehicle's engine, bi-fuel systems operation, identification of the CNG components, their location and operation, in order to service these new vehicles.

- A complete web training course on the Bi-Fuel System Operation, course #16240.70W.
The web course will provide the following:
 - How the bi-fuel system operates and performs in comparison to a traditional gasoline vehicle.
 - Identifies components involved in bi-fuel system operation and bi-fuel supply operations.
 - Bi-fuel diagnostic scenarios for a no start condition and improper CNG operation.
 - Bi-fuel inspection and maintenance process including leak checking and tank removal safety.
 - Vehicle storage.
- The vehicle uses GM Service Part Numbers and all service parts including the gaseous fuel components are available through the GM Customer Care and Aftersales (CCA) Parts Distribution System.

- Technical assistance will be provided by TAC.
- Vehicle diagnosis is accomplished using the Tech 2®/MDI.
- Powertrain diagnostics and diagnostic trouble codes (DTCs) are the same as gasoline only engines.
- The vehicle comes with a Silverado/Sierra Bi-Fuel (Gasoline/CNG) Supplement to the Owner Manual.

About the Vehicle

The 2013 Chevrolet Silverado 2500HD and GMC Sierra 2500HD will be available with extended cab only, standard or long bed and either 2-wheel drive or 4-wheel drive. The vehicle is available in all trim levels.

The Vortec 6.0L V-8 engine seamlessly transitions between gasoline and CNG.

The system design provides for primary operation on CNG as long as there is sufficient fuel in the CNG fuel tank and there are no mechanical or electrical problems detected within the system.

With the 36 gallon (136.2 L) gasoline tank and the 17.5 GGE (66.2 L) CNG tank the combined range of the vehicle is more than 650 miles (1046 km).

Notice: It is very important to know how much weight the vehicle can carry. This weight is called the vehicle capacity weight and includes the weight of all occupants, cargo, and all non-factory installed options. Two labels on the vehicle show how much weight it was designed to carry, they are the Tire and Loading Information label and the Certification/Tire label. Refer to Vehicle Load Limits in SI.

The payload of the vehicle is reduced only by the weight of the CNG system and full fuel load which is 620 lbs.

Applicable Warranty Coverage

- All components 100 % GM warranty.
- 3 Year/36,000 Miles (60,000 km) New Vehicle Limited Warranty.
- 5 Year/100,000 Miles (160,000 km) Powertrain Warranty.
- Emissions Warranty (Varies by State).
- All Warranties Fully Transferable — No Transfer Fee.

Bi-Fuel Gasoline and Compressed Natural Gas (CNG) Engine Technology



2603559

The Vortec 6.0L V-8 engine utilizes an engine control module (ECM) with both gasoline and CNG calibrations, designed to ensure all engine operating parameters are within acceptable performance operating limits. The engine has the following features:

- The engine is designed to meet strict Environmental Protection Agency (EPA) and California Air Resources Board (CARB) certification.
- A gasoline fuel injection system.
- A CNG fuel injection system.
- The hardened bi-fuel engine provides the same durability as a gasoline only engine.
- Fuel system corrosion resistance.
- Fuel system integrity and crash worthiness.
- Hardened engine components for CNG fuel usage as follows:

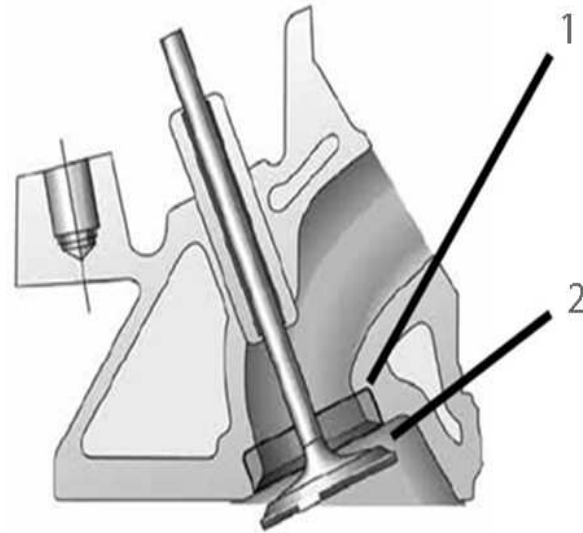

2575784

- Hardened intake and exhaust valve seats (1).
- Hardened exhaust valves (2).

Starting the Engine

Starting the engine in the bi-fuel vehicle is the same as starting a gasoline engine. The engine **always** starts on gasoline. Then, when the engine reaches a pre-determined operating temperature it seamlessly switches over to the CNG fuel system. If the CNG fuel is depleted, the system will automatically switch over to the gasoline system.

Always maintain a minimum gasoline level of at least one-quarter tank. To protect engine components, a switch to gasoline may occur at any time. The vehicle **will not** start if the engine stalls due to a lack of gasoline.

Fuel Mode Switch and Indicator / LED Fuel Gauge / Switching Between Fuels

The CNG fuel mode switch and LED fuel gauge is integrated into the dash.

When the ignition is ON, or the engine is running the CNG fuel gauge indicates how much CNG is left in the tank.

The CNG fuel gauge will display full at approximately 3,600 psi (24,800 kPa) at 70°F (21°C) and empty at approximately 500 psi (3,447 kPa) at 70°F (21°C). CNG quantity is affected by changes in fuel temperature and fuel pressure.

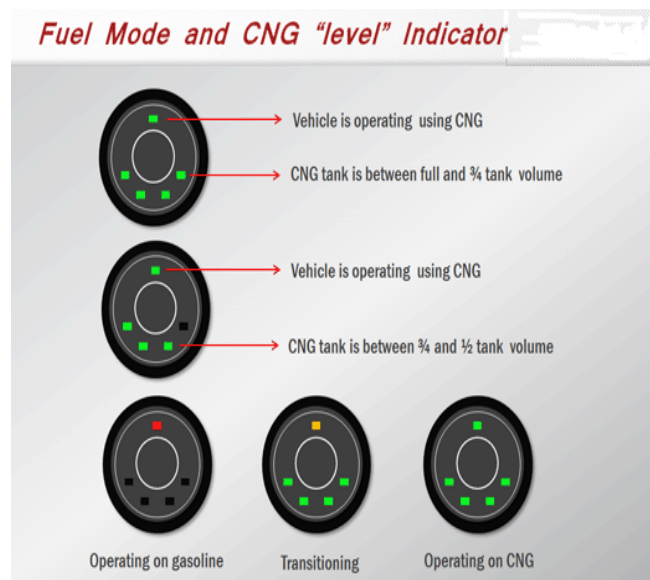

2912907

The single light at the top of the button at the 12 o'clock position, indicates which fuel system (mode) is currently in operation. The mode light will display one of three colors to indicate the current operating mode as follows:

- **Red:** Indicates the system is operating in gasoline mode.
- **Orange:** Indicates the system is changing over from gasoline to CNG. Typically this is only **ON** for 1–2 seconds.
- **Green:** Indicates the system is operating in CNG mode.

The four lights at the bottom of the button are the CNG fuel gauge and indicate the CNG fuel level as follows:

- **4 LEDs illuminated:** Full Tank to 85 % (approximately 3,600–3,100 psi (24,800–21,400 kPa))
- **3 LEDs illuminated:** 85 % to 50 % (approximately 3,100–1,875 psi (21,400–13,000 kPa))
- **2 LEDs illuminated:** 50 % to 25 % (approximately 1,875–1,000 psi (13,000–6,900 kPa))
- **1 LED illuminated:** 25 % to 15 % (approximately 1,000–500 psi (6,900–3,450 kPa))
- **1 LED Flashing:** “Low Fuel Level” from 15 % to 0 % Usable (approximately 500–0 psi (3,450–0 kPa))

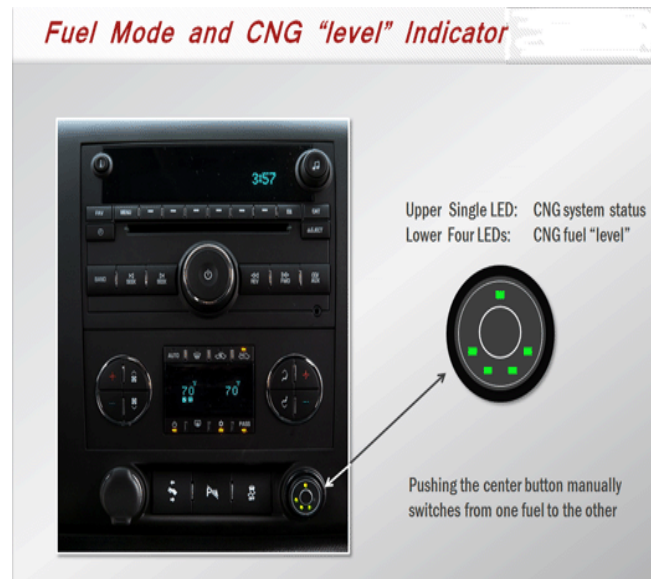

2912917

The driver can press the center of the button to switch between fuels at almost any time. The fuel mode can be changed almost any time the ignition is ON, or the engine is running.

Malfunction Indicator Lamp (MIL)

This vehicle has been specifically designed to illuminate the malfunction indicator lamp (MIL) when emissions exceed acceptable levels while operating on gasoline or CNG fuel.

The MIL will illuminate to indicate that there is a problem and service is required. Malfunctions often will be indicated by the system before any problem is apparent.

This system is designed to assist the service technician in correctly diagnosing any malfunction.

CNG Blue Diamond Identification Label



2918050

Notice: There is an identifying blue diamond-shaped CNG label on the lower right rear of the tailgate. **DO NOT** remove this label. This label is necessary for compliance with NFPA-52 regulations and insuring the vehicle. Driving without this label may violate the laws or regulations in some States or Provinces. Replacement labels can be ordered from your dealer.

CNG Fuel and Standards

In the United States, the compressed natural gas used to refuel the vehicle must meet SAE J1616, or in the state of California, Title 13 California Code of Regulations, Section 2292.5, standards for fuel composition and quality. If a fuel is used that does not meet these standards, there may be a decrease in engine power and the emission controls can be damaged.

The main component of CNG is methane, a highly flammable, colorless gas. An odorant has been added for detection through smell. While it is the same natural gas that is delivered to homes for domestic use, the CNG in the vehicle is stored under high pressure at a maximum of 3,600 psi (24,800 kPa).

The CNG system in the vehicle, including the tank, tubing and all other components on the high pressure side of the system, have been designed to hold gas at this pressure. It has also been tested for safety.

Gas should never be smelled or a hissing sound should not be heard, unless refueling is being done. If gas is smelled or a hissing sound is heard, at ANY other time, shut down the CNG system. It may be possible to hear the fuel flowing while the engine is running if standing close to the pipework or various fuel system components such as the regulator or filter. This is normal and should not be confused with a hissing sound at fittings that may indicate a fuel leak.

Refueling Station Information

The system is designed to be filled at a 3,600 psi (24,800 kPa) refueling station.

The system can be filled at a 3,000 psi (20,700 kPa) refueling station, however this will result in a reduced range of operation.

In the United States, for up-to-date information on public-access CNG station locations and prices, and to view or add user comments, see:

www.cngnow.com, www.cngprices.com and www.cngchat.com

In the United States, public and private CNG stations may also be found at the following federal government website:
<http://www.afdc.energy.gov/afdc/locator/stations/>

CNG Fuel Supply and Metering Components

The CNG fuel supply and metering system consists of the following components:

- CNG 1/4 Turn Isolation Valve (**Manual Shut-Off Valve**)
- Alternative Fuel Rail Pressure/Temperature Sensor
- CNG Coalescing Fuel Filter
- CNG Cut-Off Solenoid Valves (**2 Solenoid Valves**)
- Engine Control Module (ECM)
- Excess Flow Valve
- Fill Line Check Valve

- Fill Filter
- Fill Valve (**NGV1 Fill Receptacle**)
- Fuel Injectors / Injector Hoses
- Fuel Injector Control Module (FICM)
- Fuel Injector Rails
- Fuel Mode Switch
- CNG Fuel Pressure Regulator
- Fuel Pump Disable Module
- CNG Fuel Tank
- CNG Fuel Tank Pressure (FTP) Sensor
- CNG Fuel Tank Temperature Sensor
- CNG Tank Pressure Relief Device (PRD) (**2 Devices**)
- High Pressure Line and Hose (**Stainless Steel Tubing and Stainless Steel Jacketed PTFE Hose**)
- LED Fuel Gauge
- Low Pressure Fuel Line and Hose (**Stainless Steel Tubing and Stainless Steel Jacketed PTFE Hose**)

CNG Components / Description and Operation / Component Location

CNG 1/4 Turn Isolation Valve (Manual Shut-Off Valve)

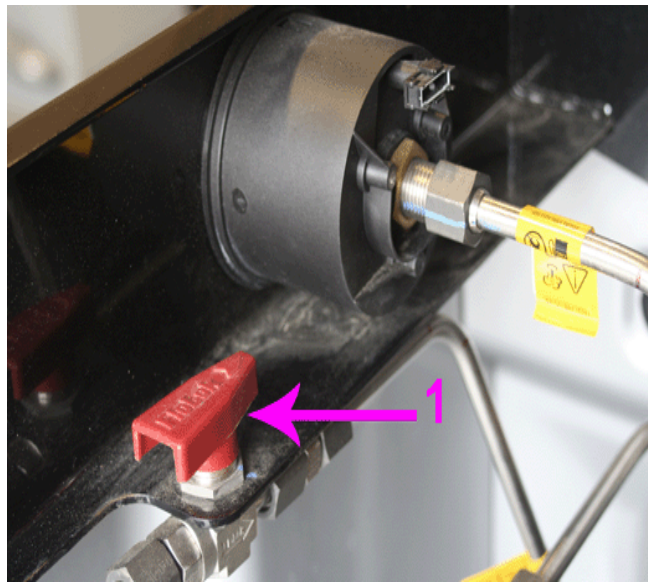

2913611

Notice: The handle on this 1/4 turn isolation valve (1) (manual shut-off valve) is RED and is located under the CNG fuel tank door as shown. This valve is shown in the ON position.

The high pressure fuel system is equipped with a manually operated 1/4 turn isolation valve (1) (manual shut-off valve), located in the high pressure supply line near the CNG fuel tank outlet (driver side). A label applied to the inside of the CNG fuel tank door, indicates the approximate location of this valve.

The purpose of the valve is to isolate the high pressure side of the fuel system for some service procedures. If this valve is inadvertently left in the **OFF** position, the vehicle will not operate in CNG mode.

Turn the manual shut-off valve (1) 90 degrees to turn **OFF** the CNG.

Alternative Fuel Rail Pressure/Temperature Sensor

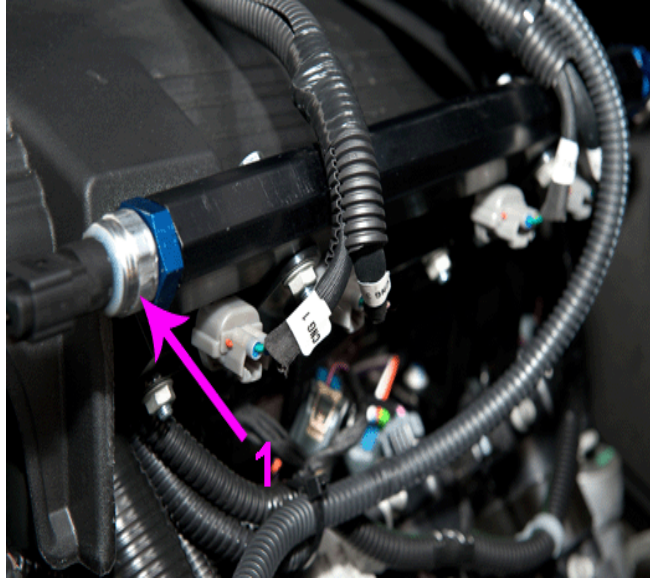

2913626

The alternative fuel rail pressure temperature sensor (1) is mounted to the right side fuel rail. It is a 4 wire sensor that provides the ECM with pressure and temperature data through the FICM serial data.

CNG Coalescing Fuel Filter



2913633

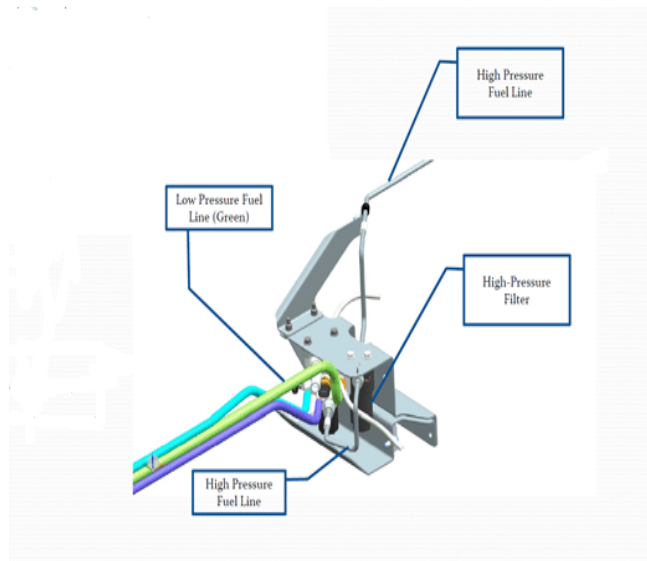

2913878

The coalescing fuel filter is located between the front CNG cut-off solenoid valve 1 and the 1/4 turn isolation valve (manual shut-off valve). The coalescing filter housing contains a 6 micron filter element and a drain fitting. The coalescing filter is designed to trap contaminants and liquids that may damage the fuel injectors.

The filter must be periodically inspected, drained and replaced.

CNG Cut-Off Solenoid Valves (2 Solenoid Valves)

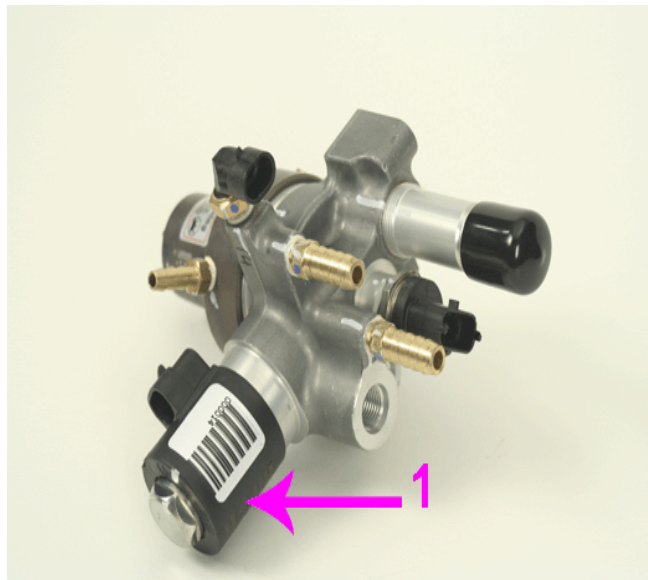

2913867

There are two cut-off solenoid valves. When they are not energized these solenoids close an internal valve to block the flow of fuel. The front CNG cut-off solenoid valve 1 (1), is integrated with the CNG fuel pressure regulator assembly.

The rear high pressure CNG cut-off solenoid valve 2 is located near the CNG fuel tank outlet. The rear CNG cut-off solenoid valve 2 has a thermally activated pressure relief device (PRD) built into the assembly. The PRD port is not controlled by the CNG cut-off solenoid valve 2 and is directly open to the internal tank pressure.

Engine Control Module (ECM)

The engine control module (ECM) monitors various engine and vehicle functions and performs all injector pulse and ignition timing calculations when operating on CNG or gasoline to ensure proper vehicle performance.

Diagnostics and diagnostic trouble code (DTC) retrieval is performed in the same manner as a gasoline only fueled vehicle.

Excess Flow Valve

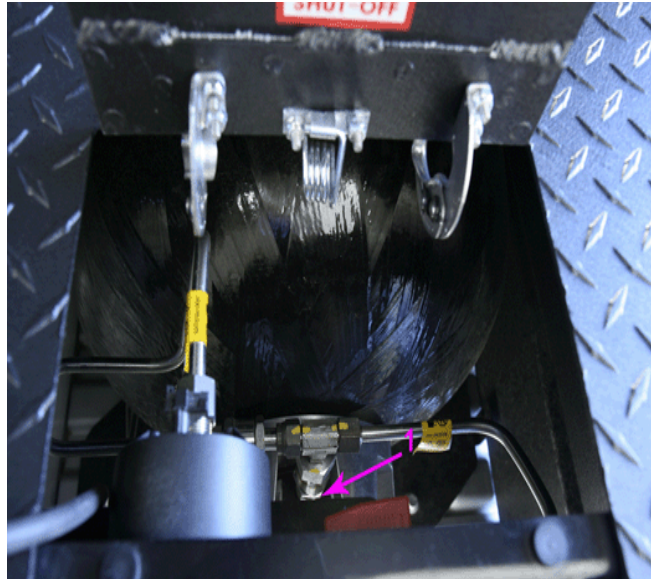

2914912

The excess flow valve is located on the CNG fuel tank outlet and is a safety device. In the event of a large leak, excessive fuel flow will cause this valve to close the outlet passages of the excess flow valve to a reduced orifice size.

Fill Line Check Valve

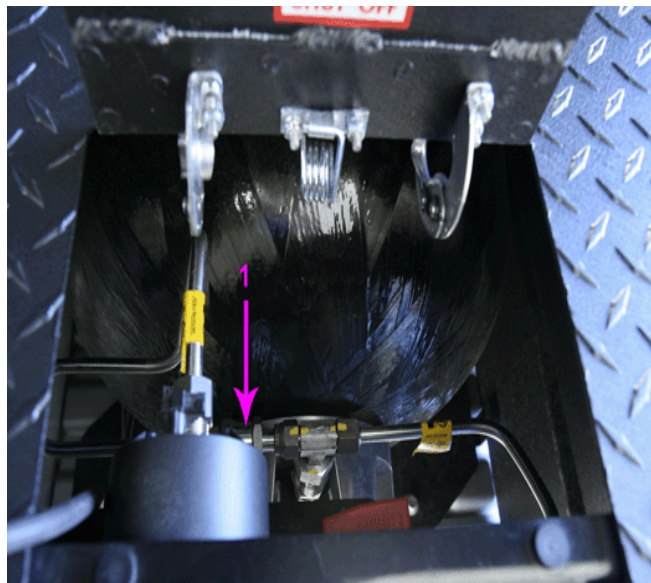

2914921

A one-way check valve is installed in the fill line after the integrated fill filter and fill valve and before the T- fitting, to prevent fuel from escaping out through the fill valve. This check valve also allows the fill filter to be serviced.

Fill Filter

A 40 micron filter is integrated with the fill valve. The filter will prevent contaminants that are 40 microns or larger from entering the CNG fuel system during refueling. When the filter becomes restricted the amount of time required to refill the CNG tank will increase.

Fill Valve (NGV1 Fill Receptacle)

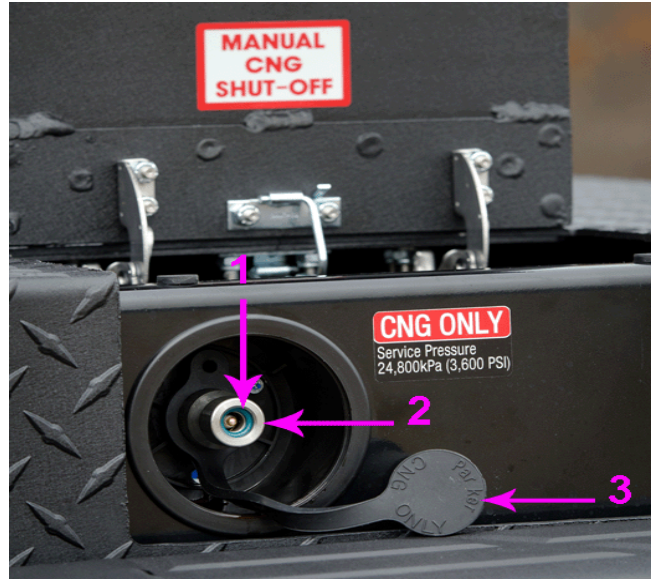

2913873

Notice: Before refueling, the O-ring (1) **MUST** be inspected and replaced if missing or damaged. Replacement O-rings are available through the GM Customer Care and Aftersales (CCA) Parts Distribution System.

The CNG fill valve (2) (receptacle) is a NGV1 profile and mates to any NGV1 fill dispenser valve. The fill dispenser seals to the receptacle (2) with an internal O-ring (1). The fill valve is mounted in the side of the CNG fuel tank cover. The fill valve has a dust cover (3) that needs to be removed for refueling. Install the dust cover after refueling.

Fuel Injectors / Fuel Injector Rails / Injector Hoses



2914068

The CNG fuel injectors are specific to gaseous fuel use.

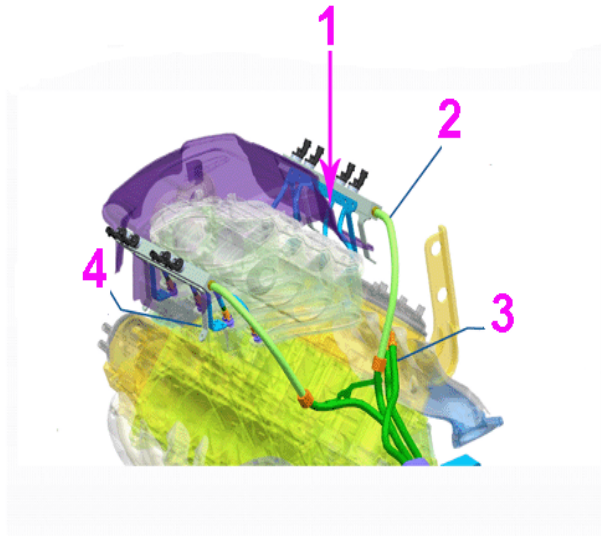

2914078

Fuel is supplied to the injectors via the fuel supply hoses (2) and the fuel rails. The operation of these injectors is controlled by the fuel injector control module (FICM). The fuel injectors are held in place by the fuel injector rails. The fuel injector rail brackets (4) are mounted to the ignition coils and intake manifold. Mounted below the fuel injector rails are injector nozzles that attach the injector hoses (1) to the modified intake manifold that has injector fittings at each cylinder.

Also pictured are the coolant lines (3) that provide coolant to the heat exchanger.

Fuel Injector Control Module (FICM)

The fuel injector control module (FICM) controls the 3 operating modes of the bi-fuel system. In **gasoline mode**, the fuel injector and fuel pump control signals are bypassed through the FICM to the proper components, allowing the vehicle to operate the same as a conventional vehicle.

In **change over mode** the FICM supplies voltage to the CNG cut-off solenoid valves, opening them at the CNG fuel tank and the pressure regulator. This allows the CNG system pressure to adjust to the normal operating pressure from the tank to the injectors. The FICM will then switch **OFF** the gasoline injectors sequentially beginning with cylinder #1. Then the appropriate CNG injectors are switched **ON** sequentially as each gasoline injector is switched **OFF**.

Once the engine is operating in **CNG mode**, the gasoline fuel pump is switched **OFF** by the FICM. The engine control module performs all injector pulse and ignition timing calculations to ensure proper engine performance.

Fuel Mode Switch

The CNG fuel mode switch and CNG fuel gauge is integrated into the dash. See the section Titled: Fuel Mode Switch and Indicator / CNG Fuel Gauge / Switching Between Fuels

CNG Fuel Pressure Regulator

The CNG fuel pressure regulator is mounted on the frame rail. High pressure CNG fuel is supplied to the regulator inlet through the high pressure fuel lines. The regulator supplies fuel to the fuel rail and injectors at a reduced pressure of approximately 130 psi (896 kPa).

The pressure drop within the regulator causes fuel temperature to drop. To prevent freeze-up, the fuel pressure regulator is connected to the vehicle engine cooling system. Engine coolant flows through a heat exchanger and into and out of the regulator, keeping it from freezing.

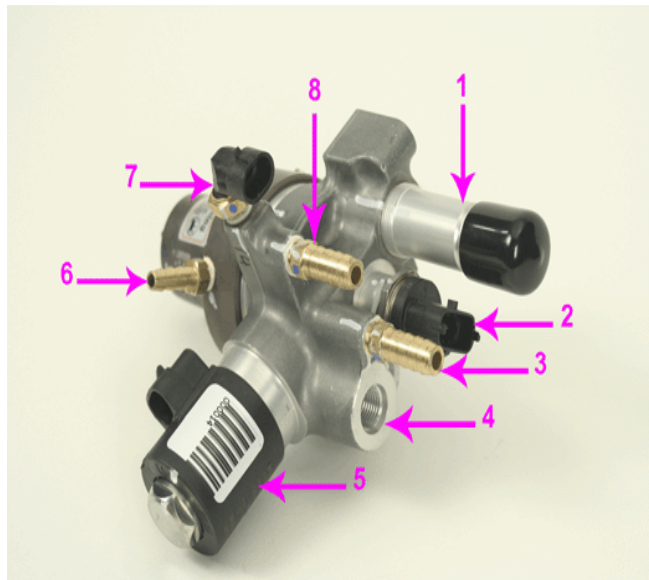

2914945

1. Over-Pressure Vent (with protective cap installed)
2. CNG Fuel Tank Pressure (FTP) Sensor
3. Engine Coolant Port (purple hose)
4. CNG High Pressure Fuel Inlet
5. CNG Cut-Off Solenoid Valve
6. Manifold Absolute Pressure (MAP) Port
7. CNG Temperature Sensor
8. Engine Coolant Port (aqua hose)

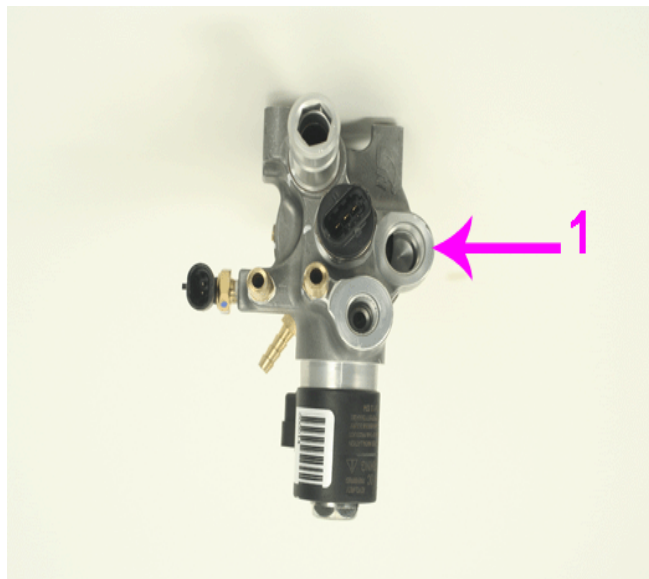

2914168

1. CNG Low Pressure Fuel Outlet

Fuel Pump Disable Module

The fuel pump disable module is used by the FICM to control when the CNG cut-off solenoid valves and fuel pump operates. During change over mode the fuel pump disable module supplies voltage to the CNG cut-off solenoid valves to charge the CNG system.

After the FICM switches from the gasoline fuel injectors to the CNG fuel injectors, the fuel pump disable module will turn **OFF** the fuel pump.

CNG Fuel Tank



2914957

The CNG fuel tank is constructed of aluminum liner wrapped in carbon fiber and conforms to NGV2-2000 (Type 3) specifications. The CNG cut-off solenoid valve 2 is threaded into the outlet end (driver side) of the fuel tank and is used to prevent fuel flow during non-operational running conditions. The service life of a Type 3 CNG fuel tank is 15 years from the date it was manufactured.



2914960

Metal shields are used to protect the tank from road debris or other contact conditions that may occur.

CNG Fuel Tank Pressure (FTP) Sensor

The fuel tank pressure (FTP) sensor is mounted on the CNG fuel pressure regulator assembly. The FTP sensor provides an input to the FICM, which uses it to determine a fuel level input. Both pressure and temperature signals are required to calculate an accurate fuel level. See the section Titled: CNG Fuel Pressure Regulator for the FTP sensor location.

CNG Fuel Tank Temperature Sensor

The CNG fuel tank temperature sensor is mounted on the rear CNG cut-off solenoid valve. The temperature sensor provides an additional input to the FICM, which uses it to determine a fuel level input. Both pressure and temperature signals are required to calculate an accurate fuel level.

CNG Tank Pressure Relief Device (2 Devices)

Notice: All external PRD devices are connected directly to fuel storage pressure and CANNOT be isolated from the high pressure system. DO NOT attempt to service these devices or connect tubing/hoses unless you are absolutely certain that the system is completely empty of CNG fuel.

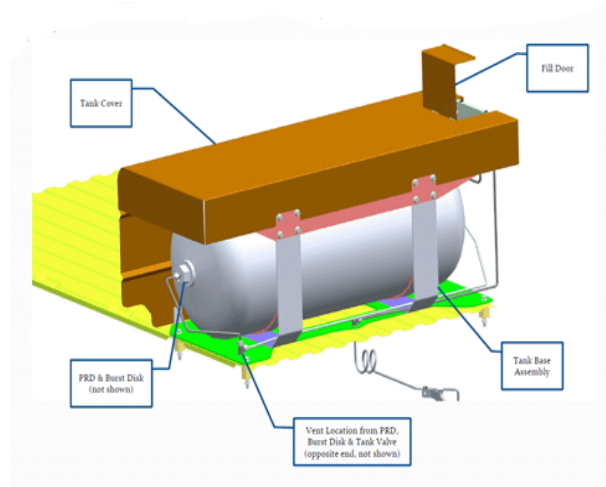

2914436

The CNG fuel tank is equipped with a **thermally activated PRD valve** that is built into the rear CNG cut-off solenoid valve 2 (driver side of tank). The PRD is sealed internally with a thermally sensitive metal valve. When the PRD is exposed to temperatures near 217°F (103°C) the metal valve will melt and allow the CNG fuel tank pressure to fully vent to the atmosphere. The PRD will not close once it has been activated. The PRD port is not controlled by the CNG cut-off solenoid valve and is directly open to the internal tank pressure.

An additional PRD is located on the opposite end of the tank (passenger side of tank), that will vent if the **pressure exceeds the calibrated level**. The CNG fuel tank must be completely vented prior to removing the external PRD. The external PRD should be inspected regularly.

High Pressure Line and Hose (Stainless Steel Tubing and Stainless Steel Jacketed PTFE Hose)

The high pressure line is a combination of stainless steel tubing and stainless steel jacketed PTFE hose that are certified to NGV 3.1. All connections between lines and components are of the O-ring Face Seal (ORFS) design and are sealed by O-rings manufactured specifically for CNG operation.

Low Pressure Line and Hose (Stainless Steel Tubing and Stainless Steel Jacketed PTFE Hose)

The low pressure line is a combination of stainless steel tubing and stainless steel jacketed PTFE hose that are certified to NGV 3.1. All connections between lines and components are of the O-ring Face Seal (ORFS) design and are sealed by O-rings manufactured specifically for CNG operation.

LED Fuel Gauge

The LED fuel gauge is integrated into the dash. See the section Titled: Fuel Mode Switch and Indicator / LED Fuel Gauge / Switching Between Fuels

CNG Fuel System Leak

Warning: *If you smell a persistent natural gas odor or hear a continual hissing sound, there could be a natural gas leak. If the natural gas is ignited, you or others could be injured. DO NOT start the engine or drive the vehicle. Have the vehicle towed to an authorized GM dealer for service.*

A slight natural gas odor may be detected for a few moments after refueling. This is normal. You should not be able to smell natural gas at ANY other time. If you do, or if you hear a hissing sound, the fuel system may have a leak.

Notice: **If natural gas is smelled or a hissing sound is heard, perform the following actions immediately:**

1. Park the vehicle in a well-ventilated area and apply the parking brake. Keep heat, sparks, and flame away.
2. Open all the vehicle doors for ventilation.
3. Turn the ignition **OFF**.

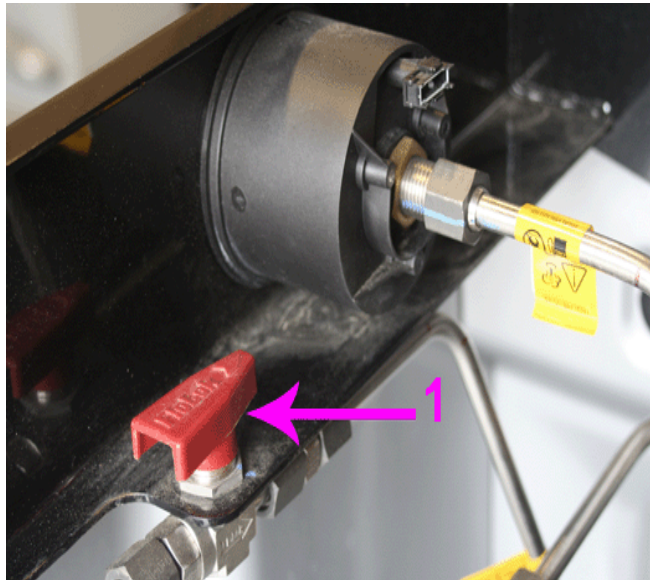

2913611

Notice: The handle on this 1/4 turn isolation valve (1) (manual shut-off valve) is RED and is located under the CNG fuel tank door as shown. This valve is shown in the ON position.

4. Turn the manual shut-off valve (1) 90 degrees to the OFF position.
5. **DO NOT** drive the vehicle. Have the vehicle towed to an authorized GM dealer for service.

Filling the CNG Tank

Warning: CNG is flammable and highly explosive. You could be killed or seriously injured if leaking natural gas is ignited. If you suspect a leak, have the vehicle immediately inspected and repaired by an authorized GM dealer.

Attempting to fill a CNG fuel system that has a missing or damaged O-ring is extremely dangerous. Natural gas can leak. If the natural gas is ignited, you or others could be injured. Replace the O-ring before filling the tank.

Refueling Procedure

Notice: When refueling in cold ambient conditions, the fuel gauge may not display "FULL" even though the temperature-compensated refueling event produces a temperature-compensated "FULL" condition. This is due to commercial refueling station output regulated by a temperature vs pressure strategy to prevent the vehicle from becoming over-pressurized if relocated to a warmer ambient location after refueling.

1. There are two methods of refueling, fast filling or slow filling. Fast filling is normally used in fuel stations for natural gas vehicles. It takes about six to eight minutes to fill up the fuel tanks. Slow filling is done with a vehicle refueling appliance or a time-fill post provided by the fleet operator. Refueling time varies depending upon the refueling system used. Consult with the refueling station attendant or system provider.
2. Always observe all safety recommendations and operating instructions on the refueling equipment. When refueling, use a fuel fill nozzle that complies with ANSI/AGA NGV-1-1994 standards. Nozzles are designed according to their maximum fill pressure as follows:
 - P30 (blue handle) for 3,000 psi (20,700 kPa). Using a blue P30 nozzle will fill the tank to approximately 7/8 on the fuel gauge.
 - P36 (yellow handle) for 3,600 psi (24,800 kPa). Refuel with a yellow P36 nozzle where available.
3. Put the vehicle into **P** (Park) and turn **OFF** the engine prior to refueling.

Notice: Before refueling, the O-ring must be inspected and replaced if missing or damaged. The vehicle is shipped with three replacement O-rings placed in the glove compartment. Replacement O-rings are available through the GM parts network.

4. Remove the dust cap from the receptacle, clean off any dirt or debris on the receptacle, and follow the refueling instructions on the pump or provided by the station operator.
5. If fuel or vapor is heard or seen leaking from the nozzle-fill valve connection, **STOP** refueling immediately. Dirt or other debris may be preventing a positive connection. Turn off the refueling dispenser, disconnect the nozzle, reconnect it to the fill valve, and begin refueling again. If it continues to leak, have an authorized dealer inspect the O-ring in the fill valve. It may be missing, damaged, or worn.

6. Refueling will stop automatically when the tank is full. To disconnect the vehicle from the refueling station, remove the nozzle from the fill valve. A hissing sound may be heard as a small amount of natural gas escapes. This is normal.
7. Put the fill valve dust cap on securely and close the fuel filler door.

CNG Fuel Pressure Relief

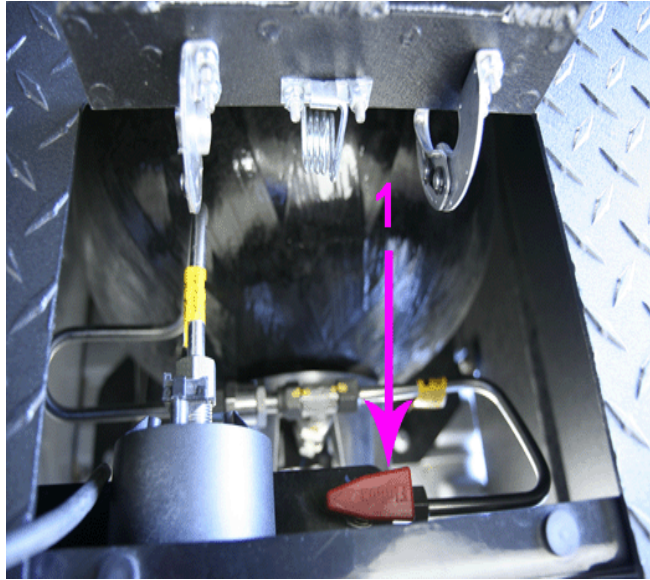

2915953

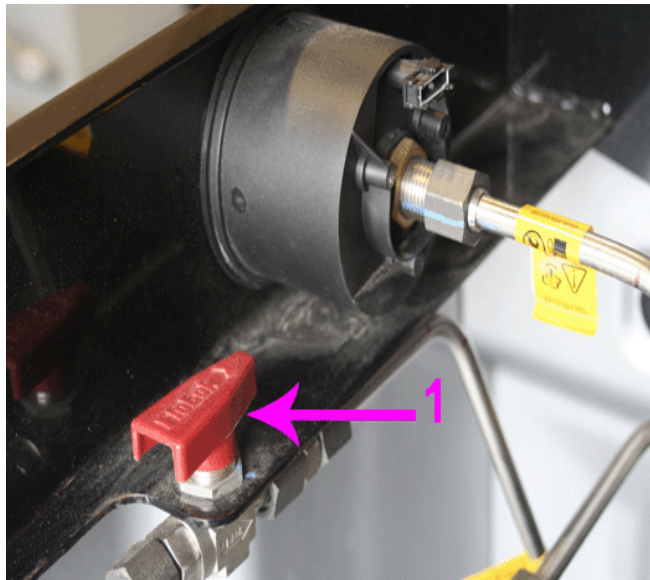

2913611

Notice: The handle on this 1/4 turn isolation valve (1) (manual shut-off valve) is RED and is located under the CNG fuel tank door as shown. This valve is shown in the ON position.

1. Turn the manual shut-off valve (1) 90 degrees to the OFF position.
2. Start and run the vehicle on CNG until the red light at the top of the CNG mode selector switch turns RED or the vehicle stalls.
3. Turn OFF the ignition.

Notice: Use caution when opening the CNG system, because the residual low side fuel pressure could be up to 145 psi (1,000 kPa).

4. After waiting until the vehicle is at room temperature and in a well ventilated area, slowly open the passenger side CNG fuel rail plug (blue), or slowly crack open a fuel line connection on the low pressure side (the engine side of the fuel pressure regulator) and allow the residual CNG system pressure to escape to atmosphere.
5. After the CNG pressure hissing sound dissipates, disconnect the CNG fuel rail plug completely and make the repairs.

CNG Tank Venting / Tank Evacuation

Notice: Only compressed natural gas (CNG) trained technicians should attempt this service procedure. Contact General Motors TAC for information and assistance with the following procedure.

1. If the fuel system is near empty, you may run the engine until the CNG tank is empty. The engine will stall or switch over to gasoline.
 - ⇒ If the fuel system is not near empty, proceed to Step 2.

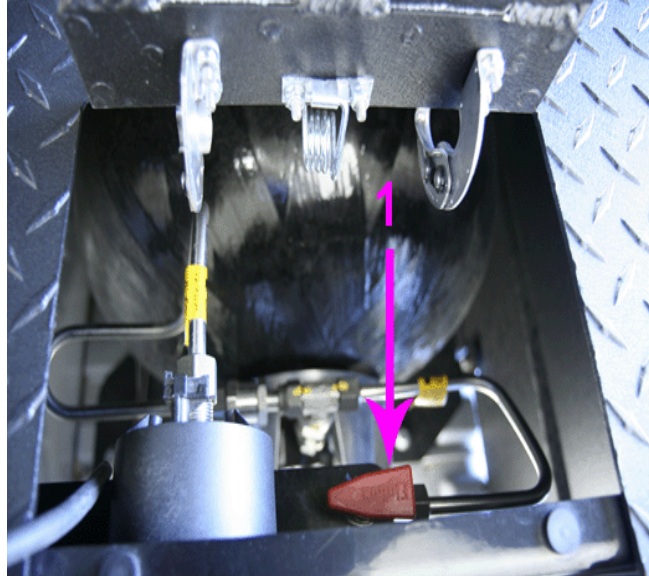

2915953

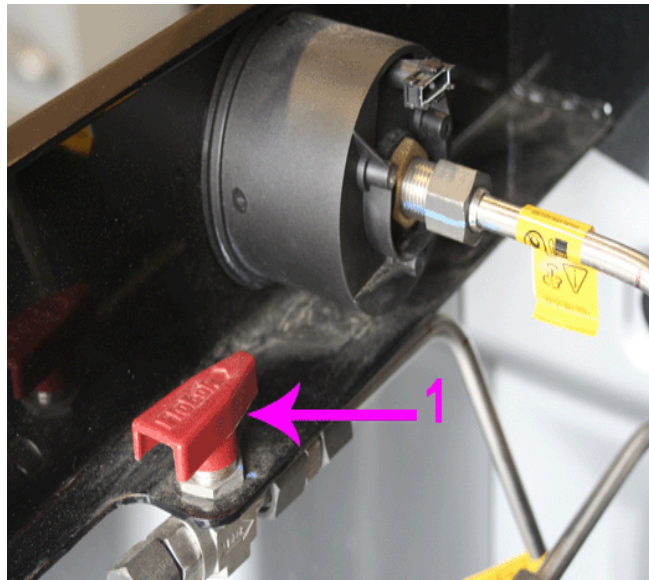

2913611

Notice: The handle on this 1/4 turn isolation valve (1) (manual shut-off valve) is RED and is located under the CNG fuel tank door as shown. This valve is shown in the ON position.

2. Turn the manual shut-off valve (1) 90 degrees to the OFF position.
3. Start and run the vehicle on CNG until the red light at the top of the CNG mode selector switch turns **RED** or the vehicle stalls.
4. Turn **OFF** the ignition.

Notice: Use caution when opening the CNG system, because the residual low side fuel pressure could be up to 145 psi (1,000 kPa).

5. After waiting until the vehicle is at room temperature and in a well ventilated area, slowly open the passenger side CNG fuel rail plug (blue), or slowly crack open a fuel line connection on the low pressure side (the engine side of the fuel pressure regulator) and allow the residual CNG system pressure to escape to atmosphere.
6. After the CNG pressure hissing sound dissipates, remove the CNG fuel rail plug completely.

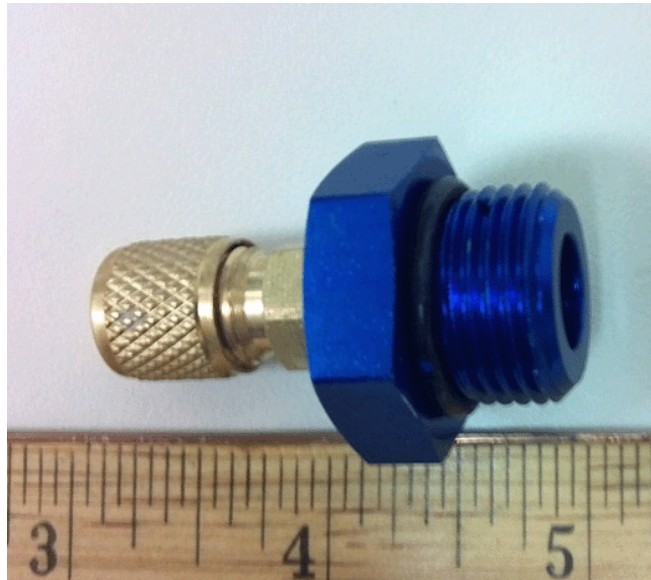

2914863

Notice: The SAE 8 O-ring fitting or the CH-51205 Fuel Pressure Release Schrader Valve (shown above) will be used to connect to a vent stack or other safe venting conduit.

7. Select a suitable SAE 8 O-ring fitting or the CH-51205 Fuel Pressure Release Schrader Valve (shown above) and install it in the vacated boss in the fuel rail.
 - ⇒ If using the CH-51205, connect the Digital Pressure Gauge CH-48027 in order to connect to the vent stack.
 - ⇒ If using a SAE 8 O-ring fitting, connect a pressure relief hose and then route it to an approved vent stack.

Notice: The pigtail harnesses do not have polarity.

8. Keeping the manual shut-off valve closed, open the regulator cut-off solenoid valve 1 by applying 12 V to the pigtail harness with a fused jumper wire. Open the rear tank cut-off solenoid valve 2 by applying 12 V to the pigtail harness with an additional fused jumper wire.

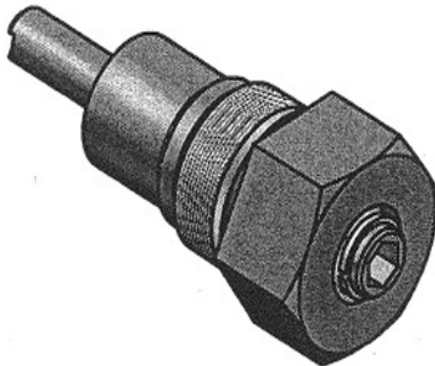

2915664

Notice: The rear tank cut-off solenoid valve 2 may not open, either because the electric solenoid is inoperable or because the valve is stuck closed.

- ⇒ If the rear tank cut-off solenoid valve 2 does not open when applying 12 V to the pigtail harness with an additional fused jumper wire, then install the CH-51210 Tank Venting Valve Override Tool. For detailed instructions for the Tank Venting Valve override tool, refer to SI.

Notice: When performing this Step visually monitor the regulator for frost or ice formation and interrupt the venting procedure as needed, by closing the manual shut-off valve in order to allow sufficient time for the frost or ice to melt.

9. **Slowly** open the manual shut-off valve 90 degrees to the **ON** position and allow the tank and fuel system to vent through the vent stack until the tank is completely depressurized.
10. The CNG fuel tank is completely vented when all of the following conditions have been met:
 - 10.1. Venting gas is no longer audible from the vent stack.
 - 10.2. If the ambient temperature is colder than 45°F (7°C), warm the CNG fuel tank and the vent assembly by placing it in a warmer environment or by spraying it with warm water.

Tech 2 is a Registered Trademark of General Motors LLC