

June 30, 2015

02076 Version 1

Warranty Extension: 2009–10 Pilot Front Suspension Rear Lower Arm Bushing

AFFECTED VEHICLES

Year	Model	Trim	VIN Range
2009–10	Pilot	ALL	Check the iN VIN status for eligibility

BACKGROUND

American Honda is extending the warranty on the front suspension rear lower arm (compliance) bushings to June 30, 2017, or 120,000 miles, whichever comes first.

This warranty covers vehicles where the compliance bushing is making noise or leaking fluid.

This warranty extension will not apply to any vehicle that has ever been declared a total loss or sold for salvage by a financial institution or insurer, or has a branded or similar title under any state's law.

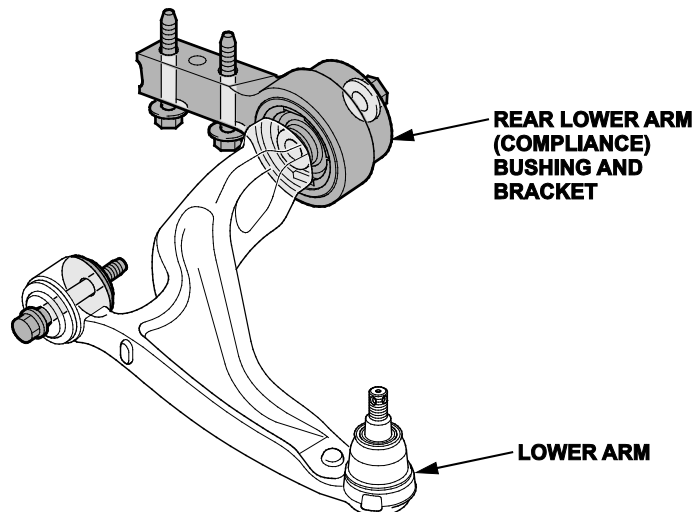

There are two bulletins that address the Pilot's compliance bushings:

- S/B 15-044, *Warranty Extension: 2009–10 Front Suspension Rear Lower Arm Bushing*, which covers some 2009–10 vehicles. The extended warranty covering these vehicles may have already expired, or will expire before June 30, 2017, **based on the original date of purchase**. To improve customer confidence, vehicles covered under this bulletin will receive a grace period that covers the compliance bushing until June 30, 2017 (or 120,000 miles) to ensure that all customers receive at least 2 years of coverage. **This bulletin will expire June 30, 2017.**
- S/B 15-045, *2009–14 Front Suspension Rear Lower Arm Bushing*. Vehicles covered under this bulletin will have the warranty on the compliance bushing extended to 7 years from the original date of purchase or 100,000 miles, whichever comes first.

CUSTOMER NOTIFICATION

Owners of affected vehicles will be sent a notification of this warranty extension in July 2015.

Do an iN VIN status inquiry to make sure the vehicle is shown as eligible.

CUSTOMER INFORMATION: The information in this bulletin is intended for use only by skilled technicians who have the proper tools, equipment, and training to correctly and safely maintain your vehicle. These procedures should not be attempted by “do-it-yourselfers,” and you should not assume this bulletin applies to your vehicle, or that your vehicle has the condition described. To determine whether this information applies, contact an authorized Honda automobile dealer.

CORRECTIVE ACTION

Replace both front suspension rear lower arm bushings if one is making noise or leaking.

PARTS INFORMATION

Part Name	Part Number	Quantity
Front Compliance Bracket Set (includes two lower arm stoppers, two self-locking nuts, two compliance bushings with bracket, six flange bolts [two different sizes] and two castle nuts)	04513-SZA-020	1

REQUIRED TOOLS

Tool Name	Tool Number
Ball Joint Thread Protector 14 mm	071AF-S3VA000
Ball Joint Remover 32 mm	07MAC-SL00100

WARRANTY CLAIM INFORMATION

2009–10 Pilot with no front wheel alignment

Operation Number	Description	Flat Rate Time	Defect Code	Symptom Code	Template ID	Failed Part Number
4191J3	Replace both front suspension rear lower arm bushings (no wheel alignment).	1.6 hrs	5YH00	JQ100	15-044A	51350-SZA-A02

2009–10 Pilot with front wheel alignment

Operation Number	Description	Flat Rate Time	Defect Code	Symptom Code	Template ID	Failed Part Number
4191J3	Replace both front suspension rear lower arm bushings.	1.6 hrs	5YH00	JQ100	15-044B	51350-SZA-A02
A	Add for front wheel alignment.	0.4 hr				

REPAIR PROCEDURE

1. Raise the vehicle on a lift.
2. Remove the front wheels.
3. Remove the lock pin from the lower arm ball joint, then remove the castle nut.

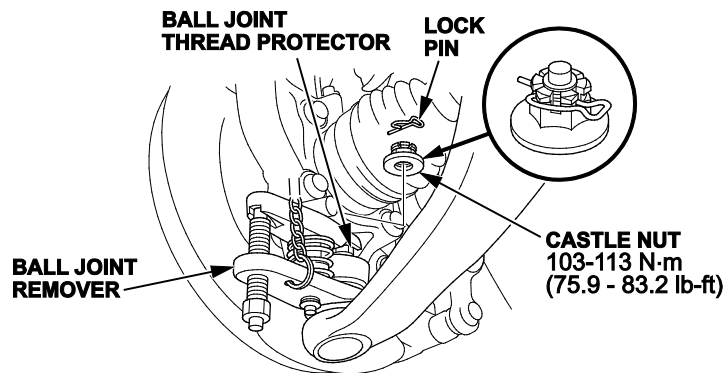

4. Disconnect the lower arm ball joint from the knuckle using the ball joint thread protector and the ball joint remover.

NOTE:

- Be careful not to damage the ball joint boot when installing the remover.
 - Do not force or hammer on the lower arm, or pry between the lower arm and the knuckle. You could damage the ball joint.
5. Remove the mounting bolt from the rear side of the stabilizer bar bushing holder.

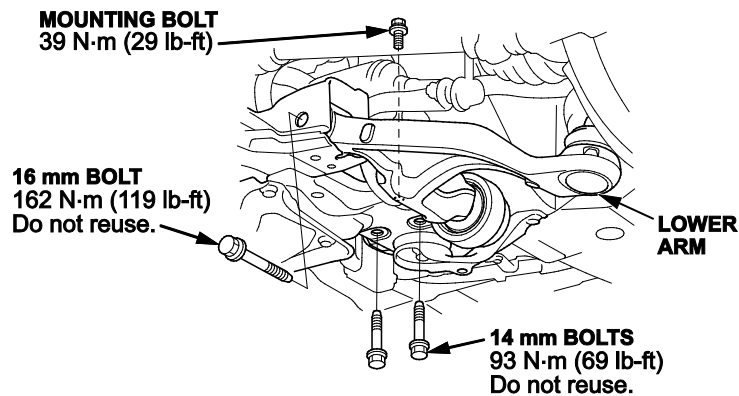

6. Remove the 14 mm and 16 mm lower arm mounting bolts, then remove the lower arm.
7. Remove the lower arm stops.

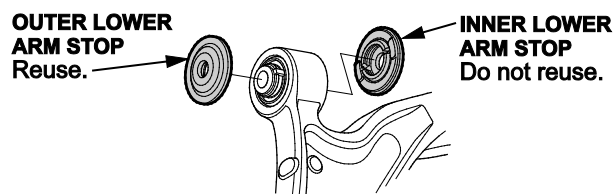

8. Remove the self-locking nut from the rear lower arm bushing, then remove the rear lower arm bushing bracket.

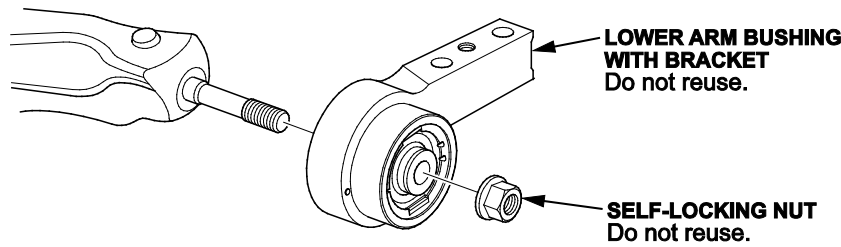

9. Install a new bushing bracket on the lower arm, then align the angle of the lower arm center line and the lower edge line of the bushing bracket as shown.

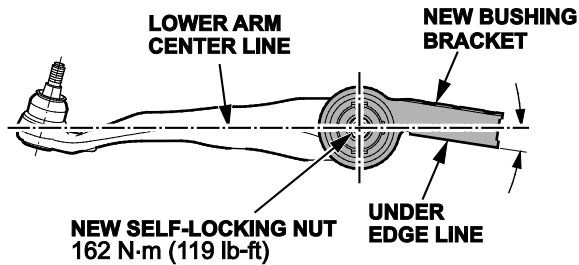

10. Install a new self-locking nut, then tighten the nut to **162 N·m (119 lb-ft)**.

11. Install the lower arm stops.

NOTE: Align the slot on the lower arm stop with the lug portion on the front side of the lower arm bushing.

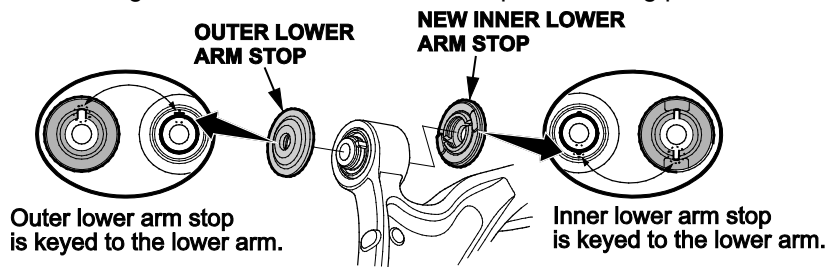

12. Install the lower arm with new bolts:

- Lightly tighten the bolts.
- Raise the suspension to load it with the vehicle's weight before fully tightening the bolts. Do not place the jack against the ball joint on the lower arm.
- Torque the 14 mm bolts to **93 N·m (69 lb-ft)**, and torque the 16 mm bolt to **162 N·m (119 lb-ft)**.
- Install the mounting bolt on the rear side of the stabilizer bar bushing holder, and torque it to **39 N·m (29 lb-ft)**.

13. Degrease the threaded section and the tapered portion of the ball joint pin, the ball joint connecting hole, and the threaded section and the mating surfaces of the castle nut. Connect the ball joint to the lower arm, being careful not to damage the ball joint boot when connecting the knuckle.

14. Torque the castle nut to the lower torque specification (**103–113 N·m [76–83 lb-ft]**), then tighten it only far enough to align the slot with the ball joint pin hole. Do not align the castle nut by loosening it. Insert the lock pin.

15. Repeat steps 3 thru 14 on the other side of the vehicle.

16. Clean the mating surfaces on the brake discs and the inside of the wheels, then install the front wheels.

17. Check the front wheel alignment and adjust it if needed.

END