

TO: Mercedes-Benz Dealer Principals, General Managers, Sales Managers, Service Managers, Parts Managers	FROM: Gregory Gunther, Department Manager, Vehicle Compliance and Analysis, Engineering Services
RE: Emission Modification Notification – [[2020050015]] MY 14 ML350 BlueTEC 4M Update – Emission Modification Category (EMC) #4	DATE: May 27, 2022

IMPORTANT EMISSION MODIFICATION NOTIFICATION

Attention Dealership Management

- Please ensure that every dealership associate is aware of this Emission Modification notification, and that customer-facing associates provide transparent information to Customers.
- Refer to VMI in NetStar to determine which units in your inventory are affected by this Emission Modification. This notification hereby instructs **Dealers not to sell or cause to be sold, or lease or cause to be leased, or introduce into commerce, or export** from the United States to another country, any vehicle covered by this notification, unless it has received the Approved Emission Modification described in this notification. **Failure to adhere to these instructions may result in possible penalties or fines.**
- Run a VMI check on all vehicles brought into your Service Department to determine if they are affected by any service campaign or recall and perform accordingly.
- Always act with the principles of Customer Experience in mind.
- Refer to the work instructions and ensure each step in the defined process is followed exactly as described. Steps such as affixing the vehicle label and correctly filling out the vehicle label must be adhered to. **Failure to adhere to these instructions may result in possible penalties or fines.**
- Ensure your warranty administrator submits warranty claims for this Emission Modification in a timely manner. Extended warranty applicability stated herein is automatically enabled once the Approved Emission Modification is completed and the warranty claim is processed.
- A proposed class action settlement has been filed that provides compensation to customers who receive the Emission Modification and meet certain other requirements. To receive such compensation, class members will need to submit (among other things) copies of their Repair Order showing proof that the Emission Modification was installed and (if any) proof of transportation expenses incurred to receive the Emission Modification—up to \$35—in the event that a loaner, shuttle, or alternative transportation cannot be arranged by your dealership. Please remind customers to save this documentation.
- Customers should **not** be given information about the Emission Modification or the class settlement that deviates from, or is in addition to, what is in authorized communications reflected in this NCU or the official websites: <https://www.mbbbluetecsettlement.com/> and <https://bluetecupdate.mbusa.com/home>. **Failure to adhere to this instruction could threaten final implementation of the settlement and may result in possible penalties.**

Other than the benefits class members can claim through the class action settlement process, customers cannot be offered any compensation in exchange for receiving the Emission Modification. **Failure to adhere to this instruction may result in possible penalties.** (At their discretion and on a case-by-case basis, Dealers can continue to offer customers goodwill for other reasons consistent with normal business practices and policies, but additional compensation in exchange for receiving the Emissions Modification is prohibited.)



Information for Customers:

- For information related to this specific Emission Modification, Customers can refer to: <https://BlueTecUpdate.mbusa.com>
- For information related to the proposed class action settlement, Customers can refer to: www.mbbluetecsettlement.com
- Mercedes-Benz Customer Assistance Center: **1-833-841-9362**

Please note that all customer inquiries should be directed to the Customer Assistance Center at 1-833-841-9362.

Sincerely,

Gregory Gunther

Department Manager, Vehicle Compliance & Analysis



Emission Modification Notification			March 17, 2021
Campaign No.:	EMC#	Campaign Desc. :	BlueTEC Update – MY14 ML (W166)
2020050015	4	19P4992006	
<p>This is to notify you of an Emission Modification to update the emission control system on approximately 4,814 Model Year (“MY”) 2014 ML350 BlueTEC 4M (W166) diesel vehicles. Emission Modification information will be visible on the https://BlueTecUpdate.mbusa.com website and may generate questions from Owners and Lessees. Affected VINs will be flagged in VMI as “OPEN” on March 17, 2021.</p>			
Background			
Issue	Mercedes-Benz USA, LLC (“MBUSA”) is modifying the emission control system on certain diesel vehicles. The Emission Modification for MY14 ML350 BlueTEC 4M(W166) vehicles has been approved by EPA and CARB, and is now ready for installation. An authorized Mercedes-Benz Dealer will install the Emission Modification at no cost to the Owner/Lessee.		
What We’re Doing	An authorized Mercedes-Benz Dealer will replace certain emission control system components and update certain software in eligible vehicles.		
Parts	An initial supply of parts will be pushed to all dealers 1/11/21. Additional parts are available to order as necessary.		
Vehicles Affected			
Vehicle Model Year(s)	MY 2014		
Vehicle Model	ML350 BlueTEC 4M (W166)		
Vehicle Populations			
Total Campaign Population	4,814		
Total Customer Vehicles in Campaign	4,814		
Next Steps/Notes			
Customer Notification Timeline	Customer letters will begin to be mailed on March 23, 2021.		
AOMS/SOMS	This Emission Modification Notification may initiate questions from customers and the media. Please ensure your Dealers have read and understand this notice.		
Notes	<ul style="list-style-type: none"> • IMPORTANT: This notification hereby instructs Dealers not to sell or cause to be sold, or lease or cause to be leased, or introduce into commerce, or export from the United States to another country, any vehicle covered by this notification, unless it has received the Approved Emission Modification described in this notification. Failure to adhere to these instructions may result in possible penalties or fines. • Follow ALL steps of the work instructions. • More information about a class action settlement providing incentives to customers who receive the Emission Modification can be found at www.mbbluetecsettlement.com • Emission Modification information: <ul style="list-style-type: none"> • Mercedes-Benz specific emission modification related information: https://BlueTecUpdate.mbusa.com • Mercedes-Benz Customer Assistance Center: 1-833-841-9362 		
<p>While we regret any inconvenience this may cause, MBUSA is determined to maintain a high level of vehicle quality and customer satisfaction. Please refer all customer inquiries to the Customer Assistance Center at 1-833-841-9362.</p>			



DEALER FAQs

What is the reason for this Emission Modification?

On March 9, 2021, Daimler AG (“DAG”) and Mercedes-Benz USA, LLC (“MBUSA”) reached a settlement with the United States Department of Justice (“DOJ”), the Environmental Protection Agency (“EPA”), the California Air Resources Board (“CARB”), and the California Attorney General’s Office (“CA AG”) regarding the emission control system in MY09 to MY16 OM642 and OM651 BlueTEC II diesel vehicles sold or leased in the US. As part of this settlement, MBUSA is offering eligible Owners and Lessees a modification to the vehicles’ emission control system, referred to as an Emission Modification.

Eligible vehicles and vehicle model years have been separated into Emission Modification Categories (“EMCs”) to facilitate the Emission Modification Program. Each EMC will be launched in phases, and MBUSA will notify authorized Mercedes-Benz Dealers after agency approval of each Emission Modification. Please refer to our public website <https://BlueTecUpdate.mbusa.com> for more information on your particular vehicle.

Is this a recall?

No, this is NOT a recall. As part of the settlement with the US authorities, DAG and MBUSA are offering eligible vehicle Owners/Lessees a modification to the vehicles’ emission control system, referred to as an Approved Emission Modification (AEM). This modification will be performed at no cost to the Owner/Lessee.

What is an “EMC”?

To facilitate the Emission Modifications on the subject vehicle population, the vehicle models and model years have been separated into Emission Modification Categories.

What are the eligible vehicles that will receive an Emission Modification under this settlement?

This settlement pertains specifically to MY09 to MY16 BlueTEC II diesel vehicles with OM642 and OM651 engines sold or leased in the US. For more information, please visit <https://BlueTecUpdate.mbusa.com>.

How will the Emission Modification be communicated to Owners and Lessees in the US?

Owners/Lessees will first receive a letter in the mail indicating that the Emission Modification is available for their vehicle and inviting them to schedule an appointment with their preferred authorized Mercedes-Benz Dealer.

How do Owners and Lessees find out whether their vehicle is affected by the Emission Modification Campaign?

Owners and Lessees with affected vehicles will be mailed a notification letter when the Emission Modification is available. Owners and Lessees can also check if their vehicle is affected by entering their VIN into the following site: <https://BlueTecUpdate.mbusa.com>.

All vehicles covered by the Emission Modification Program also are covered by the proposed class action settlement described herein.



Owners and Lessees might complain about a Check Engine light; will the Dealer repair the vehicle as part of the emissions update?

A Check Engine light can illuminate for a number of reasons. Authorized Mercedes-Benz Dealers can offer assistance diagnosing and repairing the issue.

Can an Owner or Lessee get a loaner vehicle or alternate transportation while the Emission Modification is being performed?

Where loaner vehicles are available, Dealers are requested to offer loaner vehicles to each Eligible Owner and Eligible Lessee at no cost where the implementation of the Approved Emission Modification will take 3 hours or longer to complete.

In an instance where the Approved Emission Modification takes 3 hours or longer to complete, and where the Dealer does not make available a loaner car or offer a shuttle service or alternative transportation, Class Members will be eligible to submit a claim for transportation costs of up to \$35 along with their claims for other settlement compensation. For more information on the transportation allowance, customers should visit the class action settlement website at www.mbbbluetecsettlement.com, and should be reminded to save their receipts.

What is Mercedes-Benz going to do for Owners and Lessees given this inconvenience?

Dealers will attempt to minimize any inconvenience during the Emission Modification process. Should Owners or Lessees experience an excessive delay with the Emission Modification of their vehicle, they can contact our Customer Assistance Center at 1-833-841-9362.

As part of the proposed consumer class action resolution, current owners and lessees of eligible vehicles who go to authorized Mercedes-Benz Dealers, have an Approved Emission Modification installed, and meet certain other requirements will be eligible to claim a payment of up to \$3,590. For more information on eligibility and the process for filing a claim, customers should call the number above or visit the class action settlement website at www.mbbbluetecsettlement.com.

Other than the benefits that class members can claim through the class action settlement process, customers cannot be offered any compensation in exchange for receiving the Emission Modification. **Failure to adhere to this instruction may result in possible penalties.** At their discretion and on a case-by-case basis, Dealers can continue to offer customers goodwill for other reasons consistent with normal business practices and policies, but additional compensation in exchange for receiving the Emission Modification is prohibited.

Where can an Owner or Lessee have the Emission Modification work completed?

Owners and Lessees will be asked to contact their local preferred authorized Mercedes-Benz Dealer to arrange for an appointment to complete the FREE Emission Modification.

Can Owners and Lessees have the Emission Modification performed if they did not receive a Notification Letter in the mail but own a Mercedes-Benz BlueTEC diesel vehicle?

Owners and Lessees should first check the eligibility and status of their vehicle by visiting <https://BlueTecUpdate.mbusa.com>. To be automatically alerted when the Emission Modification is available for their vehicle, Owners and Lessees are being asked to complete the "Keep me Updated" section of the website after entering their VIN to check the status.



Do Owners and Lessees have to wait for the notification letter in the mail before their vehicle can receive the Emissions Modification?

Owners and Lessees do not need to present a copy of the notification letter to receive the FREE Emission Modification, but they should wait to bring their vehicle in for the Emission Modification until they receive notice that the Emission Modification has been launched for their specific vehicle model. The Emission Modifications will be launched in phases, pending agency approval, so the Emission Modifications for all of the subject vehicle models (all MY09 to MY16 BlueTEC II diesel vehicles with OM642 and OM651 engines sold or leased in the US) will not be launched at the same time. Once the Emission Modification has been approved for a particular vehicle type, Owners and Lessees will be sent a letter asking them to schedule an appointment with their authorized Mercedes-Benz Dealer to perform the FREE Emission Modification.

Do Owners or Lessees need the Owner/Lessee notification letter to have the Emission Modification performed?

No, Owners and Lessees with eligible vehicles do not need the notification letter to have the FREE Emission Modification completed. Local authorized Mercedes-Benz Dealers can check the eligibility and status of vehicles without the letter.

What about Owners or Lessees who request that the Emission Modification be performed without first receiving a letter?

No Emission Modification can be performed until EPA and CARB approve the Emission Modification for the specific model. Similarly, the affected VIN must be flagged as "OPEN" in VMI with the respective Emission Modification campaign number for the modification to be performed.

When will parts be available?

Parts are currently available for the Emission Modifications which have been approved by EPA and CARB. We will provide updates as parts become available for other vehicle models.

Regarding all other future vehicle categories, MBUSA is working with EPA and CARB to obtain approvals for the Emission Modification. MBUSA will notify Dealers upon approval of each Emission Modification that the Emission Modification has become available.

For up-to-date parts availability information, please refer to the website <https://BlueTecUpdate.mbusa.com>.

Are there any known vehicle symptoms associated with the Emission Modification that Owners or Lessees will notice that should lead them to stop driving or take their vehicle to a Dealer?

No. There are no symptoms related to the Emission Modification.

What is the expected impact on an Owner's or Lessee's vehicle after the Emission Modification has been performed?

Details on the impact to vehicles are provided in the letter for each Emission Modification Category. A copy of the Owner/Lessee letter for the EMC subject to this FAQ is attached.

What types of repairs or replacements are needed?

Authorized Mercedes-Benz Dealers will replace specific emissions-related components. This varies by model and model year. For more information, please visit <https://BlueTecUpdate.mbusa.com>.



How long does this Emission Modification take?

Replacement time is dependent upon the model and model year. This time may range from 30 minutes to a maximum of 6 hours. Details are provided in the Owner/Lessee notification letter.

What if vehicles have been modified using after-market parts and/or software? Can the Emission Modification still be performed?

If, prior to receiving the Emission Modification, the vehicle has been modified in a manner that impedes the installation of the AEM or substantially affects the operation of the AEM after install (for example, removal of original emissions components not part of the AEM), dealers might not be able to perform the Emission Modification until the prior modifications are corrected. The Owners/Lessees would be responsible for such corrections. Once corrected, the vehicle may receive the Emission Modification.

What if Owners or Lessees decline to have the Emission Modification performed?

If Owners/Lessees decline the Emission Modification at this time, they will be advised by their authorized Mercedes-Benz Dealer that certain emissions-related replacement and repair parts (for their existing system) may no longer be available from Mercedes-Benz at some point in the future. Additionally, the current vehicle Owner/Lessee will not be able to make a compensation claim as part of the proposed class action settlement without first having the Emission Modification performed on their vehicle.

Will eligible vehicles have any warranty on the Emission Modification?

Yes. Once the Emission Modification is performed, certain components will have an extended warranty for the greater of 4 years/48,000 miles from the date of installation of the Emission Modification or 10 years/120,000 miles from the initial sale date of the vehicle. As described in the Customer Letter, some emission-related components have an additional extended warranty period, which is added to the applicable Extended Modification Warranty period above. This extended warranty remains with the vehicle and is fully transferable to subsequent owners until expiration. Where loaner vehicles are available, Dealers are requested to offer loaner vehicles to each Eligible Owner and Eligible Lessee at no cost where extended warranty repairs exceed three hours to complete.

Can Owners or Lessees be denied coverage under the Extended Warranty for the Emission Modification?

The Extended Warranty for the Emission Modification may be denied if an eligible vehicle has been altered with the use of any after-market emissions-related components, parts, and/or software, or with the removal of any original emissions-related components, parts, and/or software, and such alteration(s) are likely to substantially affect the operation of the vehicle with the Emission Modifications, until the owner of such vehicle, at his or her expense, has reversed the alteration(s) such that the Emission Modification will not be substantially affected.





Mercedes-Benz

Campaign No. 2020050015 March 2021

Revision A 3/25/2021

TO: ALL MERCEDES-BENZ CENTERS

SUBJECT: **Model ML350 BlueTEC diesel vehicles (166 platform)****Model Year 2014****Modification to the emission control system**

Mercedes-Benz USA, LLC ("MBUSA") is performing an emission campaign on certain ML diesel vehicles in order to modify to the vehicles' emission control system. EPA and CARB have approved this emission modification for the MY14 (ML166) diesel vehicles. An authorized Mercedes-Benz dealer will replace certain emission control system components and update certain software in the affected vehicles at no cost to the owner of the vehicle.

Prior to performing this Emission Campaign:

- Please check VMI to determine if the vehicle is involved in the emission modification campaign and if it has been previously repaired. Always Check VMI for any open campaigns, and perform accordingly.
- Please review the entire Emission Campaign bulletin and follow the repair procedure exactly as described.

Approximately 4817 vehicles are involved.

Order No. P-EC-2020050015

This bulletin has been created and maintained in accordance with MBUSA-SLP S423QH001, Document and Data Control, and MBUSA-SLP S424HH001, Control of Quality Records.

Scope of Work:

Note: Videos of exemplary modifications of a GLK250 (MY13) BlueTec and a ML350 BlueTec (MY12) can be found on WIS Service Media (WSM):

GLK250 BlueTec: WSM → Content by model series → Passenger Cars → GLK (Model 204.9) → 49 – Exhaust system

ML350 BlueTec: WSM → Content by model series → Passenger Cars → ML (Model 166) → 49 – Exhaust system

Work procedure

1. Initial Short Test and Initial Inspection
2. Disconnect Battery Ground
3. Replace Combination box (DOC+DPF)
4. Remove lower engine compartment trim
5. Replace NOx sensor control units downstream of the Selective Catalytic Reduction (SCR) catalyst and particulate sensor
6. Loosen the wheel arch fairing and Replace NOx sensor control unit after the Diesel Particulate Filter (DPF)
7. Replace SCR
8. Connect ground
9. Connect XENTRY diagnosis
10. Perform Xentry Procedure: Service Measure "Exhaust Aftertreatment System" (includes update of CDI, and SCR software)
11. Perform Final Short Test
12. Attach the adhesive label

Parts Overview

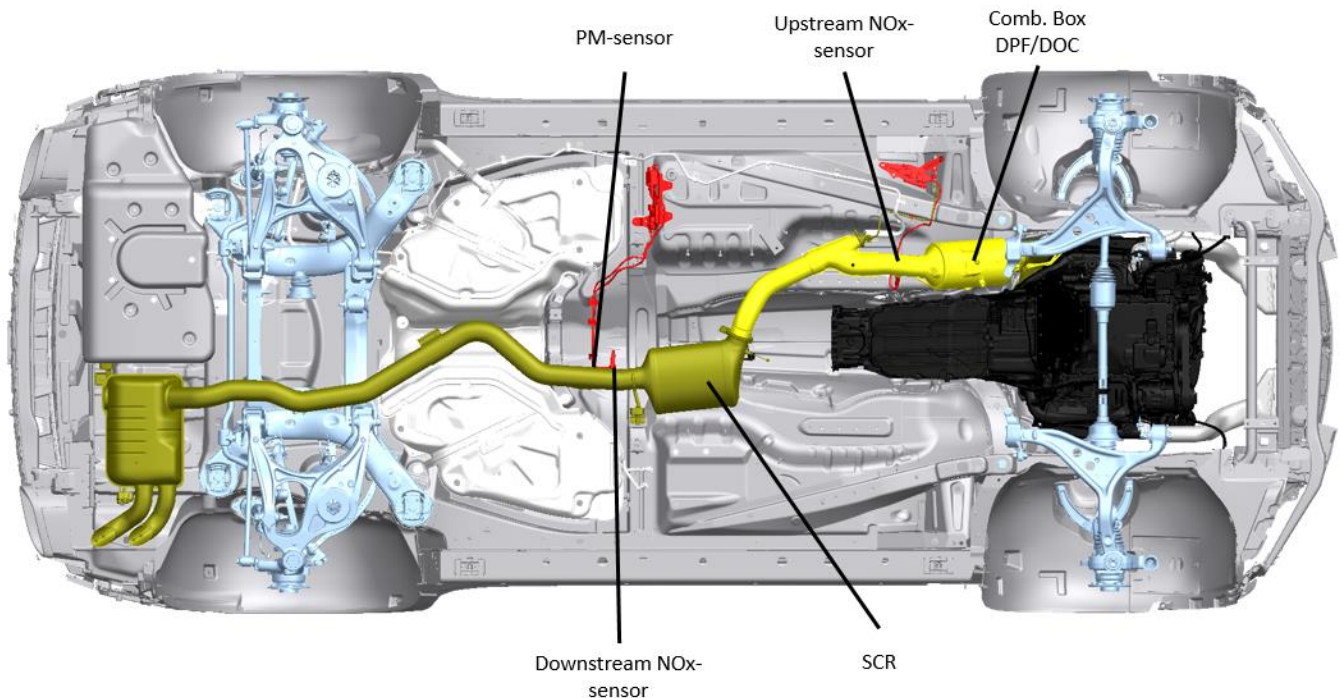

Procedure

1. Initial Short Test and Initial pre-inspection



i Before starting the work procedure, an initial short test must be completed per below. Existing issues that would inhibit the installation of all software and hardware components outlined in this work procedure must be initially addressed.

1.2 Connect XENTRY diagnosis.

i Note:

- Use DAS/Xentry 09/20-with all associated patches or higher.
- Follow the steps exactly as described in DAS/Xentry.
- Connect battery charger (battery voltage  >12.5V).
- Ensure all electrical consumers are switched-off.
- In the event of software/SCN update issues, contact Star Diagnosis User Help Desk. Please refer to the “pre-call” check list before contacting UHD
- Refer to Star Diagnosis System (SDS) Best Practices Guide.

1.3 Perform Short Test

i Follow the Xentry procedure “Emission Modification Pre-Inspection”: “Control units view  N3/9 – Motor electronics ‘CDI60LS’ for combustion engine ‘OM642’ (CDI)  Special procedures  Emission Modification Pre-Inspection

Record findings on workorder and save to paperless

i Note: goal of the pre-inspection process is to perform an inspection of the emission system and ensure all components are present and functioning correctly (Check engine light “CEL” ON/OFF). The pre-inspection consists of the following procedures as displayed in the below flowchart:

1. **Visual inspection** of the emissions system to check for non-compliant alterations to the emission system that impedes the installation of the AEM or substantially effects the operation of the AEM after installation. This consists of a brief visual inspection and does not require a technician to confirm if components are operating correctly. (Example: missing emission system components not replaced as part of the AEM)
 - a. If an alteration has been found during the visual inspection that meet the criteria mentioned in point 1, please advise the customer these alterations must be reversed at their expense before to proceed with the AEM. Please follow the below process to submit a warranty claim for the time associated to diagnosis and provide an estimate to the customer.

Warranty Documentation Process:

 1. Claim against damage code 4910N 01 – Approved Emission Modification Denial
 2. Up to 2 hours of diagnostic time permitted
 3. Ensure diagnostic time is properly punched on the RO
 4. Ensure RO is documented properly including a detailed explanation as to why the modification was denied
 5. Attach the RO to the warranty claim
2. **Initial Short Test** to check for CEL ON/OFF: Pre-existing issues (CEL ON) may be addressed at the time of AEM install if the components diagnosed are part of the AEM or extended warranty. For all other components, please provide a customer a repair estimate and document if the customer approves/declines the additional repair(s). It is essential the AEM is installed regardless if the customer approved/declines additional repairs to address a pre-existing issue. A list of applicable extended warranty parts is available in Xentry for the technician to refer to.

1.4 Pre-Inspection Overview (Figure 1)

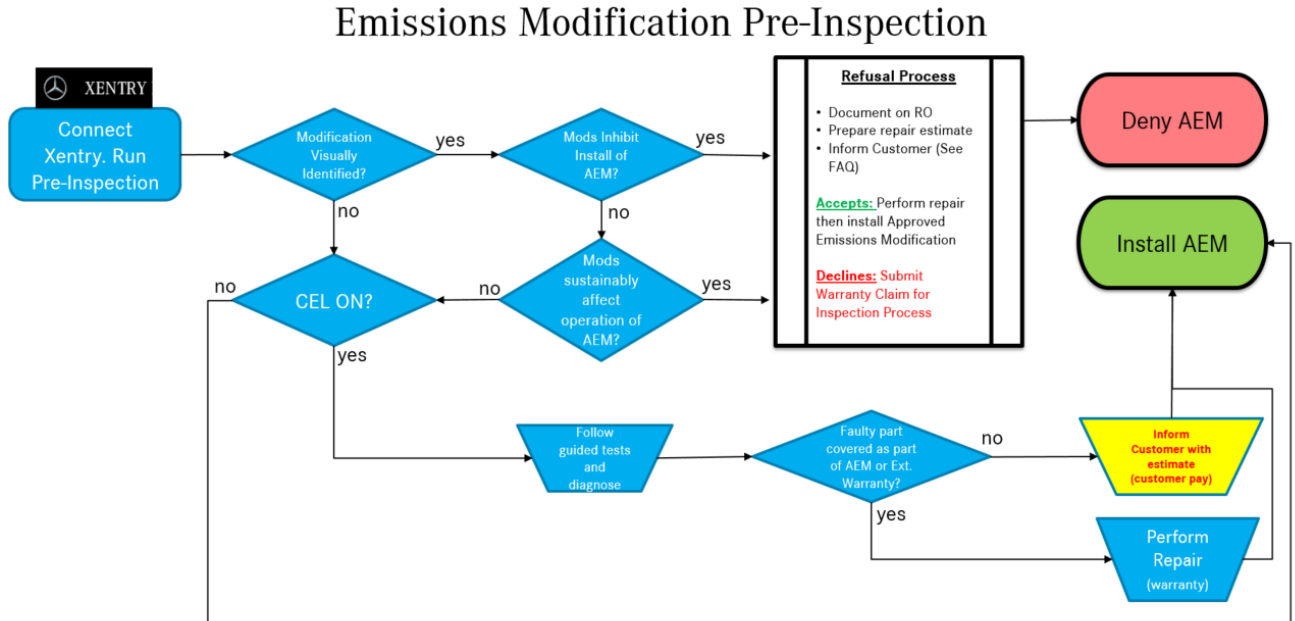

Figure 1

1.5 Disconnect XENTRY diagnosis and remove battery charger

2. Disconnect battery ground (**AR54.10-P-0003CW**).

3. Using a chain pipe cutter, cut off the exhaust system tailpipe at a right angle to the muffler at the separating point that is marked by the stamped-in notch (**figure 2**).

i Be sure to support the rear muffler and secure it so that it doesn't fall.

i A different tool (such as a saw) may be used for cutting.

i **Installation:** Check installation position and unobstructed movement of the exhaust system. The exhaust system must be installed so that it is free of tension. Align the exhaust system if necessary.

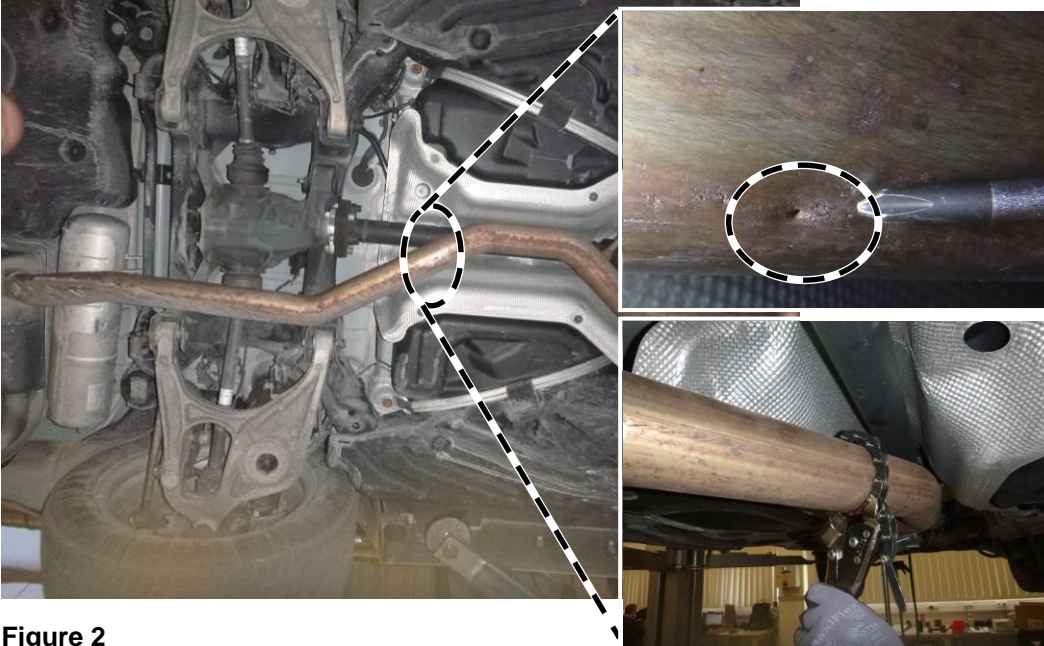

Figure 2

4. Replace components of the exhaust system (catalytic converter diesel particulate filter unit **(see notes in Parts Information)** and SCR catalytic converter) and both NOx sensors and particulate sensor.

- i** For basic data, see **AR49.10-P-7100GQB**, the NOx sensors are replaced.
- i** The NOx sensor and particulate sensor does **not** have to be unscrewed from the exhaust pipe.
- i** The pigtail wire at NOx sensor should be cut for ease of removal and to ensure it is not reused **(Figure 3)**.



Figure 3

- i** For basic data on NOx sensor replacement, see AR49.20-P-2060OGR, AR49.20-P-2062OGR.

The NOx sensor upstream of SCR has to be installed to the vehicle (wire routing behind heat shields) before installing the new DPF.

- i** The reset routine does not have to be performed at this point.
 - i** NOx sensor upstream of SCR catalytic converter (A 000 905 57 12) and NOx sensor downstream of SCR catalytic converter (A 000 905 58 12).
 - i** The installation position of the NOx sensor downstream of the SCR catalytic converter has been changed on the new exhaust pipe (**figure 4**).
 - i** The new sensors are already equipped with paste, hot lubrication.
 - i** Transfer the rubber damper from the old diesel particulate filter to the new part.
 - i** Remove all adhesive labels on the diesel particulate filter and SCR catalytic converter.
- i** When reinstalling exhaust components leave the mounting hardware loose until all the exhaust components are in place. This will allow for flexibility when fitting the components together.



Figure 4

5. Reconnect battery ground (**AR54.10-P-0003CW**).
6. Connect XENTRY diagnosis. Update characteristics of the control unit

i Note:

- Use DAS/Xentry 9/20 with all associated patches or higher.
- Follow the steps exactly as described in DAS/Xentry.
- Connect battery charger (battery voltage  >12.5V).
- Ensure all electrical consumers are switched-off.
- In the event of software/SCN update issues, contact Star Diagnosis User Help Desk. Please refer to the “pre-call” check list before contacting UHD
- Refer to Star Diagnosis System (SDS) Best Practices Guide.

7. Perform Xentry procedure “Service Measure Exhaust Aftertreatment System”

i i To do so, select menu item “Control units view” → N3/9 – Motor electronics ‘CDI60LS’ for combustion engine ‘OM642’ (CDI) → Special procedures → Perform Service Measure “Exhaust aftertreatment system”

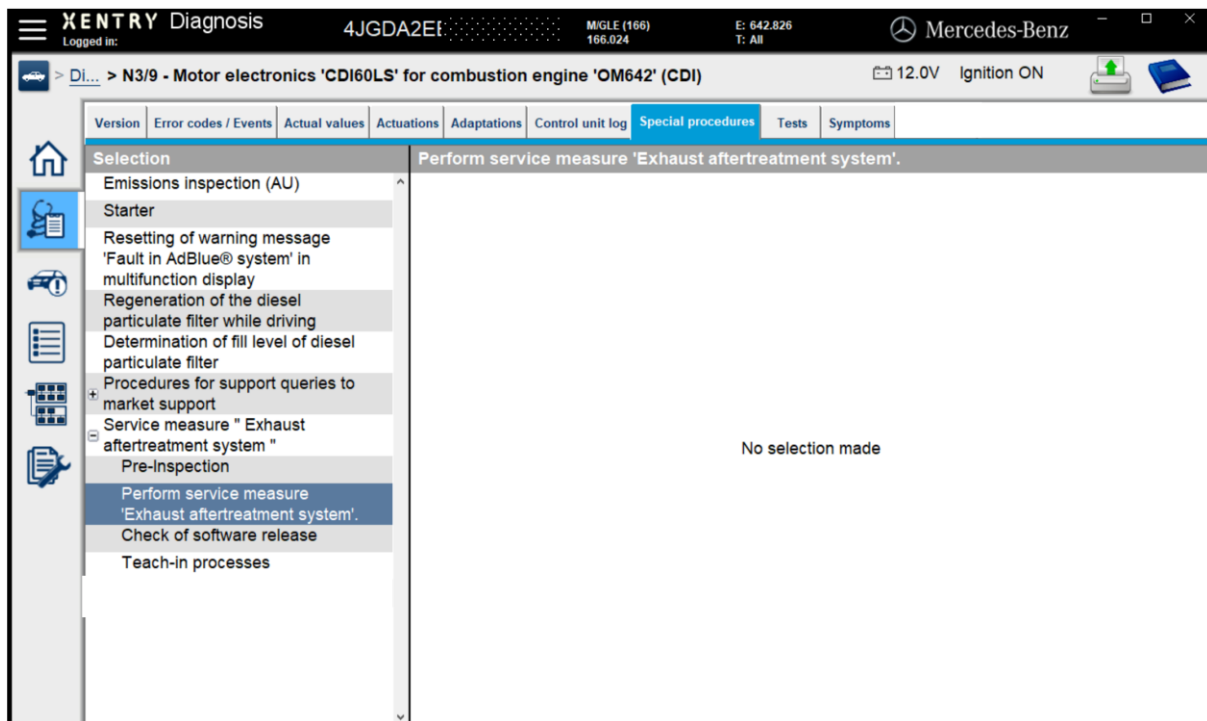

Figure 5

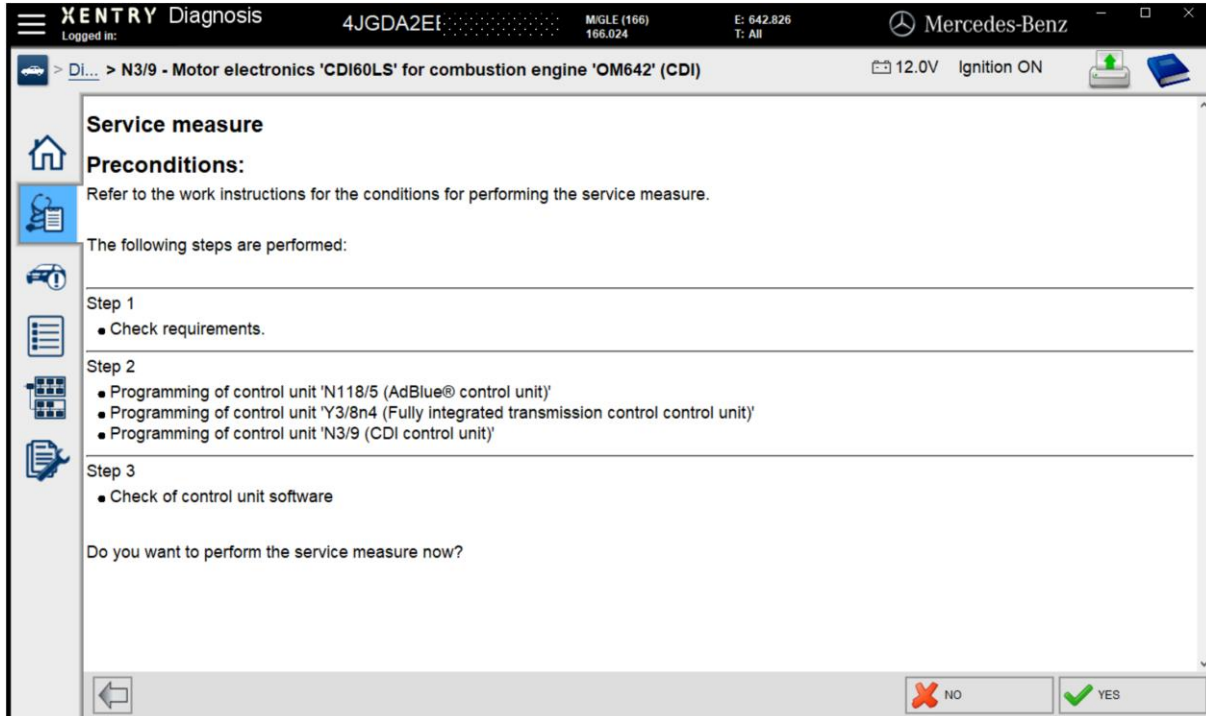

Figure 6

- i** Subsequently, follow the user guide in XENTRY diagnosis.
- i** Additional control units will be updated **automatically** in the background.
- i** Fill out emission label according to Xentry instructions

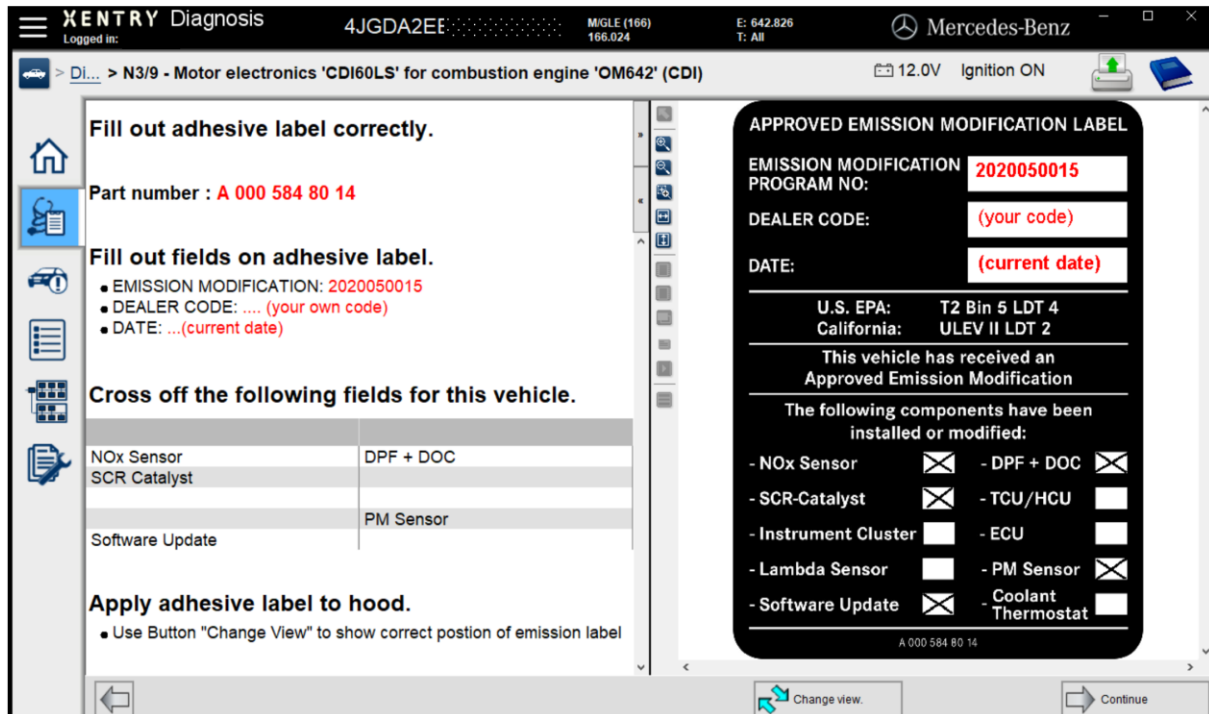

Figure 7

i Check screen will be shown at end of procedure.

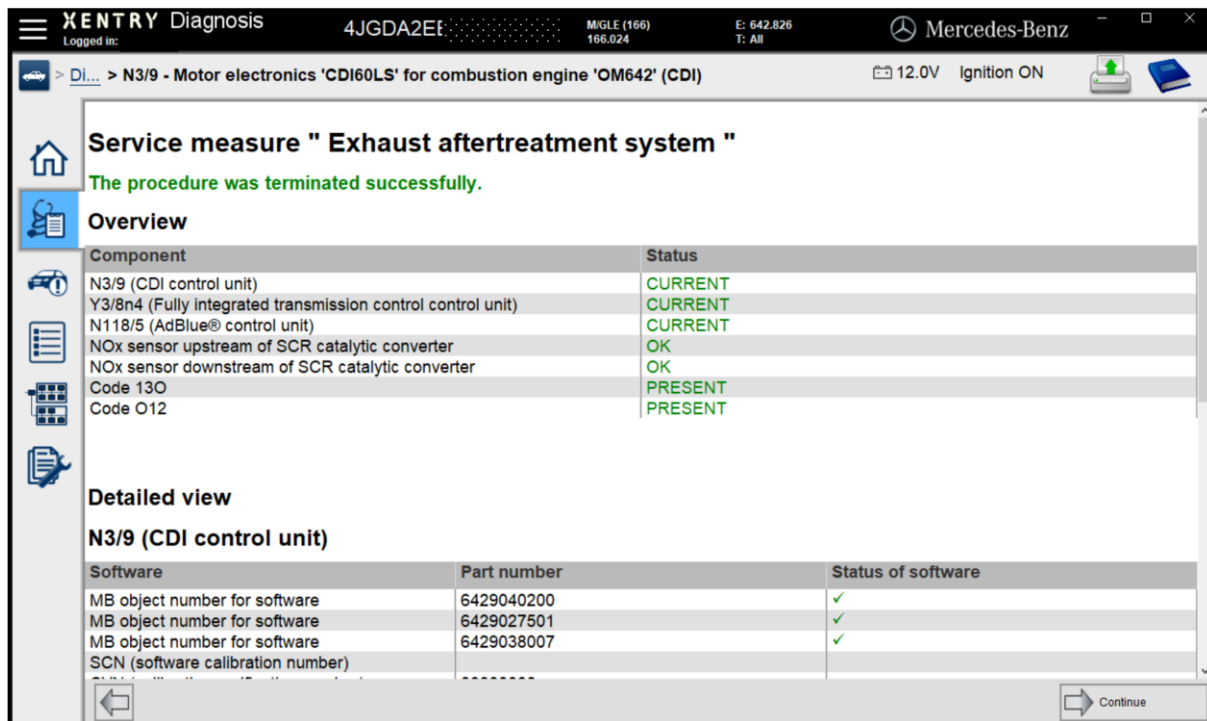

Figure 8

8. Perform a final quick test and transmit to paperless SDS.

i Faults stored in the memory, caused by disconnected lines during the inspections, must be deleted from the fault memory after completing the work.

i The procedure via the diagnostic system is shown on the following pages.

i If faults are present and stored they need to be addressed. Create a PTSS case

9. Clean the bonding surface of the hood and attach the adhesive label (**Figure 9**).

i The fields on the adhesive label must be filled out correctly. Please use black permanent marker.

Refer to (**Figure 7**) within the Xentry procedure

i The adhesive label can be applied to the hood **while** updating the software for the engine control unit.

i **Failure to comply may result in dealer debit and/or possible fines.**

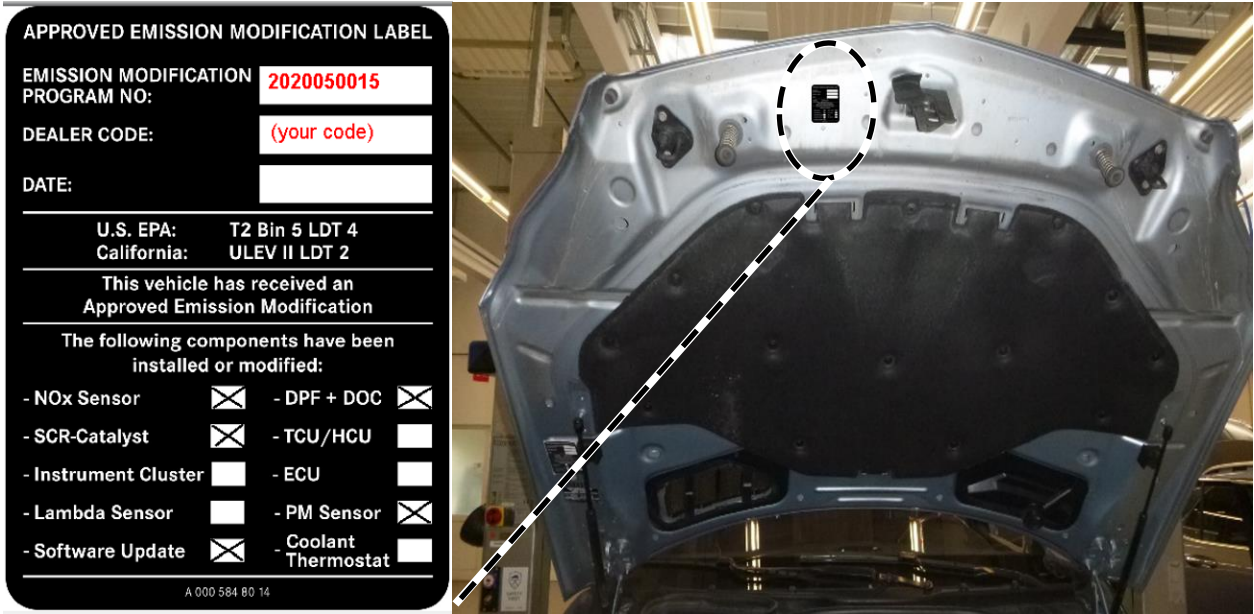

Figure 9

Primary Parts Information

Qty.	Part Name	Part Number
1	Parts kit (2x NOx sensors, 1x PM sensor)	A 642 905 12 00 85
1(as required)	Combination box (DOC+DPF) with Code 804 + 054	A 166 490 12 02 80*
1(as required)	Combination box (DOC+DPF) with Code 804 without 054	A 166 490 13 02 80*
1	SCR catalytic converter	A 166 490 31 02 80
1	Small parts set	A 166 490 29 02 05
1	Adhesive label	A 000 584 80 14

*See Figure 10/11 (below) for picture of Combination Box for further identification

i Small parts such as screws, stop nuts, sealing rings, cable ties, liquids, sealants, etc. that are not listed in the parts list. The small parts required (per WIS instruction) are included in the cost and can be claimed.

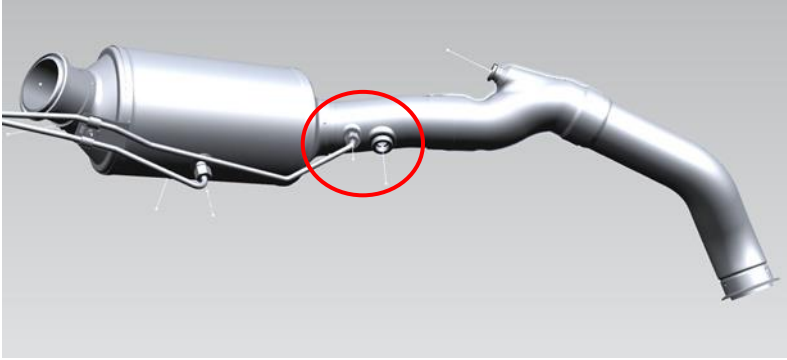

Figure 10 – A 166 490 12 02 80 for vehicles with option code 804(MY14) and with option code 054 – Note the pressure line connection location

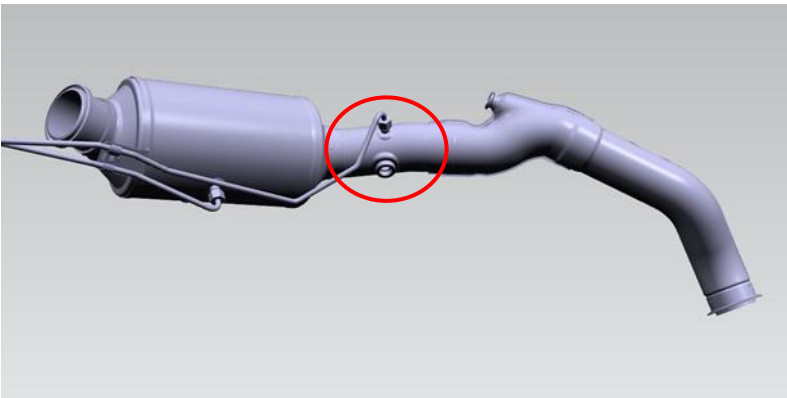

Figure 11 – A 166 490 13 02 80 for vehicles with option code 804(MY14) and without option code 054 – Note the pressure line connection location

Warranty Information

Operation: Replace components of the exhaust system (02-1016)

Includes: Carry out commissioning the Control units (CDI, NOx, SCR) with XENTRY and affix AEM Label.

Damage Code	Operation Number	Labor Time (hrs.)
49 920 06	02-1016	4.2