

- ATTENTION:**
- GENERAL MANAGER
 - PARTS MANAGER
 - CLAIMS PERSONNEL
 - SERVICE MANAGER

IMPORTANT - All Service Personnel Should Read and Initial in the boxes provided, right.

© 2023 Subaru of America, Inc. All rights reserved.



QUALITY DRIVEN® SERVICE

PRODUCT CAMPAIGN BULLETIN

APPLICABILITY: 2021MY Crosstrek
 2022MY Forester
 2021-23MY Legacy
 2021-23MY Outback

NUMBER: WRQ-23R

DATE: 12/12/23

REVISED: 01/31/24

NHTSA: 23V-755

SUBJECT: Safety Recall – Transmission Inhibitor Switch Replacement

Subaru of America, Inc. (Subaru) has initiated a safety recall for certain 2021 model year Crosstrek vehicles, certain 2022 model year Forester, and certain 2021-2023 model year Legacy and Outback vehicles.

DESCRIPTION OF THE DEFECT AND SAFETY RISK:

The vehicles included in this recall may contain an inhibitor switch that was manufactured with an insufficient weld between the switch stator and cover which may allow water intrusion.

Over time, moisture intrusion may cause the inhibitor switch to become inoperative. An inoperative inhibitor switch may result in the backup lamps not illuminating when in reverse gear, the rear-view monitor not displaying, the transmission gear select indicator in the instrument panel not being displayed, or inability to start the engine.

REMEDY:

For all the potentially affected vehicles, Subaru dealers will replace the inhibitor switch with a new one at no cost to the customer.

AFFECTED VEHICLES:

A total of 95,830 U.S. vehicles will be affected by this recall, as listed below. Not all vehicles in the production range listed below are affected by this recall. Coverage must be confirmed by using the Vehicle Coverage Inquiry function on subarunet.com prior to repair.

Model Year	Carline	Production Date Range
2021	Crosstrek	February 8, 2021 – July 30, 2021
2022	Forester	July 26, 2021 – July 27, 2021
2021-2023	Legacy	March 18, 2021 – August 25, 2022
2021-2023	Outback	March 17, 2021 – May 16, 2022

CAUTION: VEHICLE SERVICING PERFORMED BY UNTRAINED PERSONS COULD RESULT IN SERIOUS INJURY TO THOSE PERSONS OR TO OTHERS.

Subaru Service Bulletins are intended for use by professional technicians ONLY. They are written to inform those technicians of conditions that may occur in some vehicles, or to provide information that could assist in the proper servicing of the vehicle. Properly trained technicians have the equipment, tools, safety instructions, and know-how to do the job correctly and safely. If a condition is described, DO NOT assume that this Service Bulletin applies to your vehicle, or that your vehicle will have that condition.

Subaru of America, Inc. is ISO 14001 Compliant

ISO 14001 is the international standard for excellence in Environmental Management Systems. Please recycle or dispose of automotive products in a manner that is friendly to our environment and in accordance with all local, state and federal laws and regulations.

Continued...

RETAILER RESPONSIBILITY:

Please be advised that it is a violation of Federal law for a dealer to deliver a new motor vehicle covered by a recall under a sale or lease until the defect is remedied. Therefore, any Authorized Subaru Retailer failing to perform the applicable service procedures to correct all affected vehicles in their inventory prior to the vehicle being placed in service may be subject to civil penalties of up to \$26,315 per violation (i.e., for each vehicle), as provided in 49 CFR §578.6 and will also be in breach of the Subaru Dealer Agreement.

Any vehicles listed in any recall/campaign that are in retailer stock must be:

- Immediately identified.
- Tagged or otherwise marked to prevent their delivery or use prior to repair.
- Repaired in accordance with the repair procedures outlined in the Product Campaign Bulletin.



Retailers are to promptly perform the applicable service procedures, to correct all affected vehicles in their inventory (used, demo & SSLP). Whenever a vehicle subject to this recall is taken into retailer inventory necessary steps should be taken to ensure the recall correction has been made before selling or releasing the vehicle.

OWNER NOTIFICATION:

Subaru will notify affected vehicle owners by first class mail on January 8, 2024. Retailers will be advised when owner notification is scheduled.

PART INFORMATION:



Kit Part Description	Qty	Kit Part Number
SWITCH -INHIBITOR KIT	1	X31918AA120

Kit Components		
Part Description	Qty	Image
SWITCH-INHIBITOR	1	
STR PIN-5X22	1	

NOTE: These parts are available for order through PRIME only.

Continued...

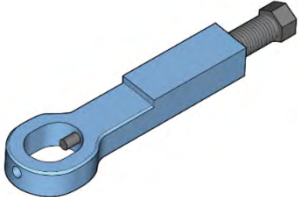
REQUIRED TOOLS:

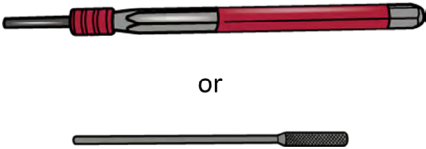
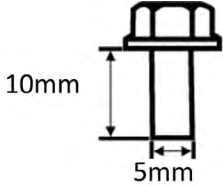
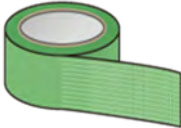
Tool Description	Image	Details
<p>REMOVER-PIN (Part Number: 99804AN070)</p>		<p>For removing the spring pin.</p>
<p>5mm pin punch (Tip diameter 4.8mm)</p>		<p>For installing the spring pin.</p>
<p>4mm pin punch (Tip diameter 4.0mm) or SST: Stopper Pin (Part Number: 499267300)</p>	 <p style="text-align: center;">or</p>	<p>For adjusting the inhibitor switch.</p>
<p>M5x10mm bolt</p>		<p>For spring pin insertion guide.</p>
<p>3M 401 Masking Tape (or equivalent)</p>		<p>For protecting the gear selector cable boot.</p>

NOTE: The Pin Removal Tool (99804AN070) will be automatically shipped to all retailers.

CAUTION: Due to the limited supply of the Pin Removal Tool (99804AN070), it is vital to refrain from using any power tools in conjunction with the Pin Removal Tool. The use of power tools will cause damage to the tool and replacements are currently on backorder status.

Continued...

COMPONENT CONFIGURATION:

- Defective parts
- ★ Non-reusable parts
- ▭ Removable parts
- Tightening torque

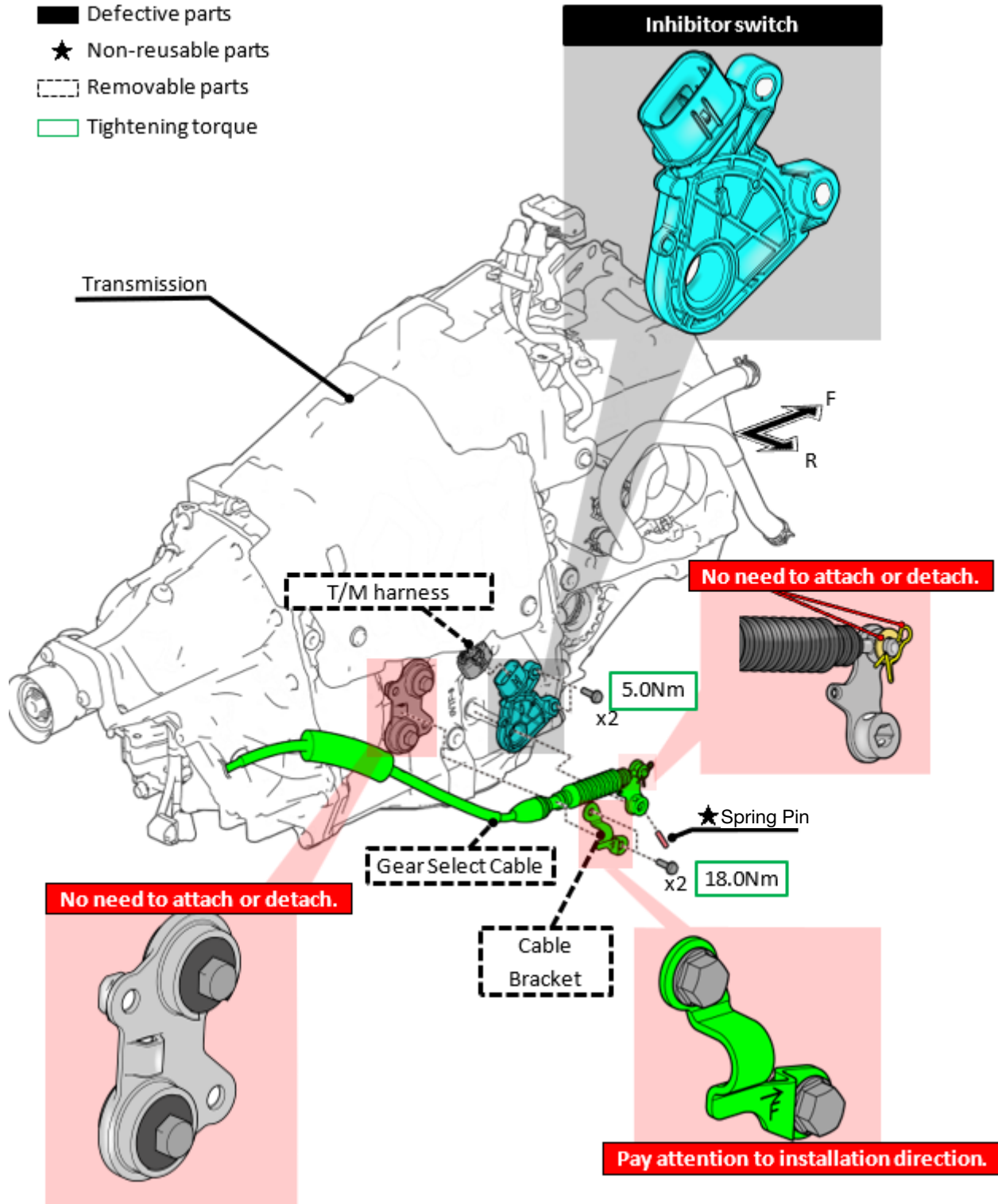

Continued...

SERVICE PROCEDURE:

The following service procedure has been outlined in a Work Tips Video for additional Technician reference.

[Work Tips Video](#)

STEP 1: Apply the electronic park brake by pulling the switch in the upward direction.

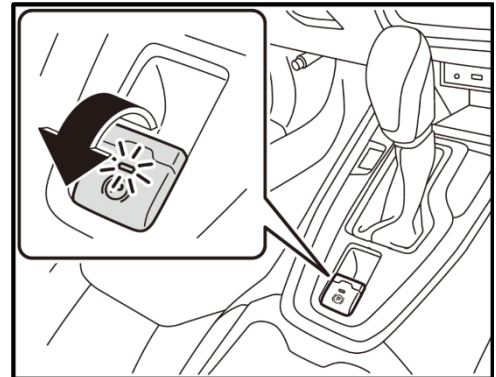

STEP 2: Using a plastic trim tool, remove the rubber pad located in front of the gear selector.

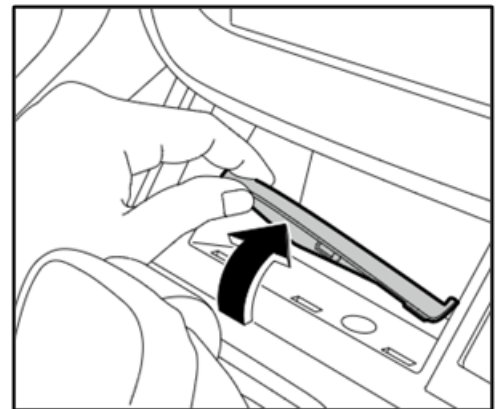

STEP 3: Insert a small screwdriver into the round hole located under the rubber pad. This will release the gear selector lock. Move the gear selector into the Neutral position.

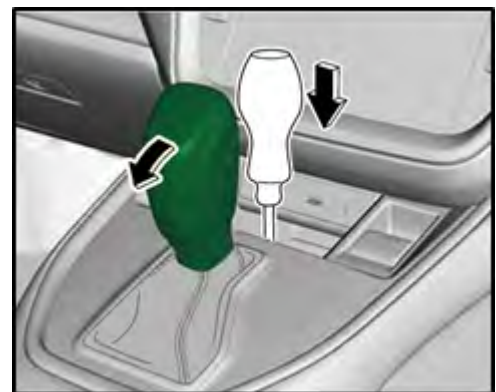

Continued...

STEP 4: Refer to the applicable Service Manual and review: General Description > Repair Contents > Action required before & after Battery Disconnect. Additionally, record any stored seat position(s) before proceeding. Relearn any seat position memory after work is complete. If the power rear gate (PRG) height has been customized, that position must also be noted and relearned.

STEP 5: **CARFULLY** disconnect the negative battery cable from the battery sensor.

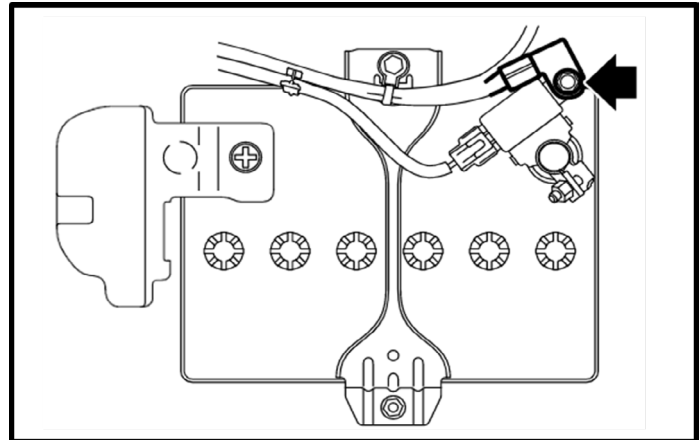

STEP 6: Lift the vehicle following the procedures specified by the lift manufacturer.

STEP 7: Cover the rubber gear selector cable boot with masking tape to prevent any damage during the next steps. Refer to the Work Tips Video at 00:00.

NOTE: 3M™ High Performance Green Masking Tape 401+ or equivalent can be used for this procedure.

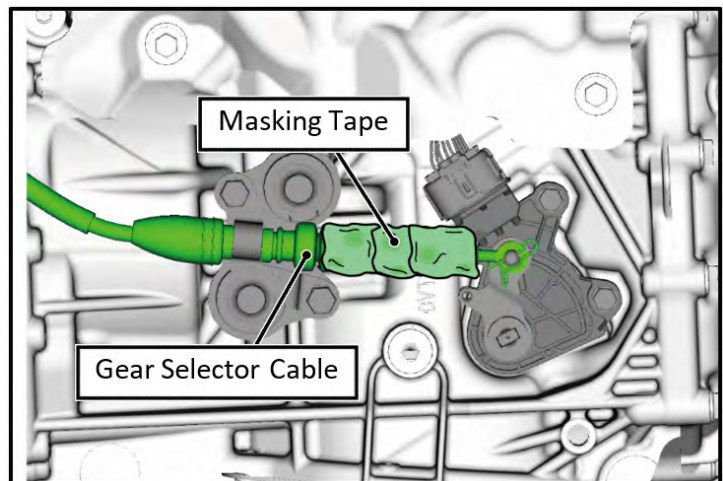

STEP 8: Prepare the pin removal tool (99804AN070) by turning the threaded portion of the tool counterclockwise to allow room for installation.

STEP 9: Install the pin removal tool over the spring pin located on the gear selector arm. The notched side should be facing the transmission case. Slowly turn the threaded portion clockwise by hand until the driving pin of the tool is aligned with the spring pin.

Continued...

CAUTION: CONFIRM the drive pin and the hole located on the top of the removal tool are aligned with the spring pin. Any applied pressure without proper alignment may cause damage.

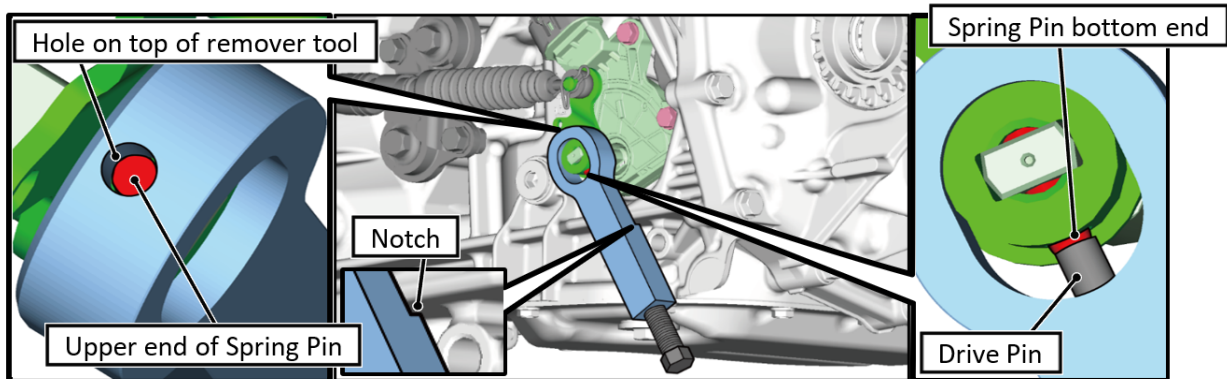

STEP 10: Using **HAND TOOLS ONLY**, tighten the threaded portion of the removal tool until the spring pin is fully removed. Discard the spring pin once it is fully removed. **DO NOT** reuse the spring pin.

CAUTION: Due to the limited supply of the Pin Removal Tool (99804AN070), it is vital to refrain from using any power tools in conjunction with the Pin Removal Tool. The use of power tools will cause damage to the tool and replacements are currently on backorder status.

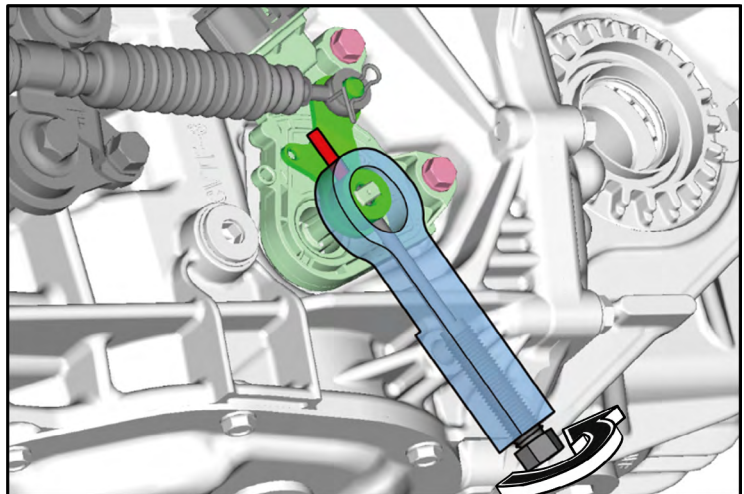

STEP 11: Loosen the removal tool and remove it from the shifter arm.

STEP 12: Using a marker or paint pen, make an alignment mark on the cable bracket and cable plate as show in the right image. This mark will be utilized in further steps.

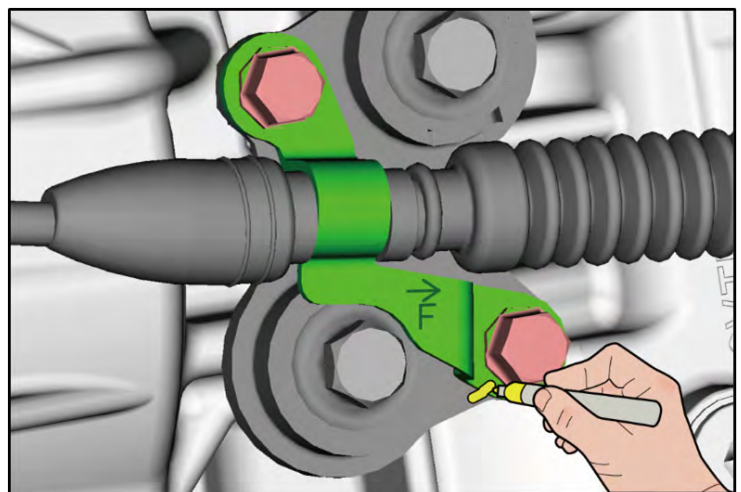

Continued...

STEP 13: Remove the two retaining bolts and remove the cable bracket.

CAUTION: **DO NOT** remove the cable plate.

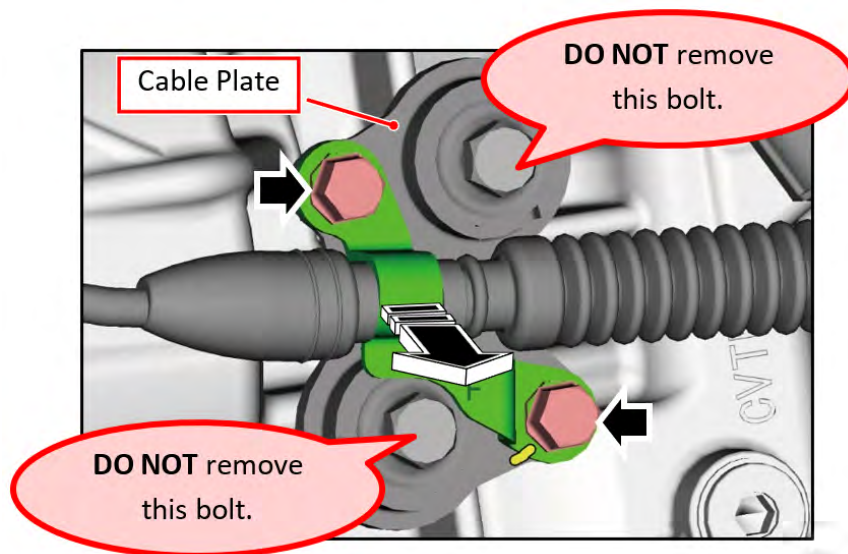

STEP 14: Remove the gear selector cable and shifter arm together from the shifter arm shaft.

CAUTION: It is possible for the shifter arm to be stuck to the shifter arm shaft. A small pry bar or screwdriver can be used to assist the release of the shifter arm. **DO NOT** apply any excessive force to the gear selector cable.

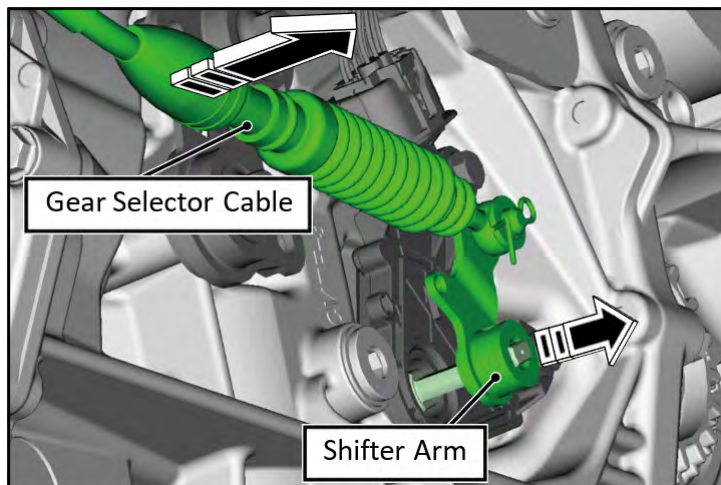

Continued...

CAUTIONS WHEN REMOVING AND INSTALLING THE GEAR SELECTOR CABLE:

DO NOT apply an impact or a load to part (a) of the gear selector cable shown in the picture below. Doing so may damage the resin guide pipe inside the boot.

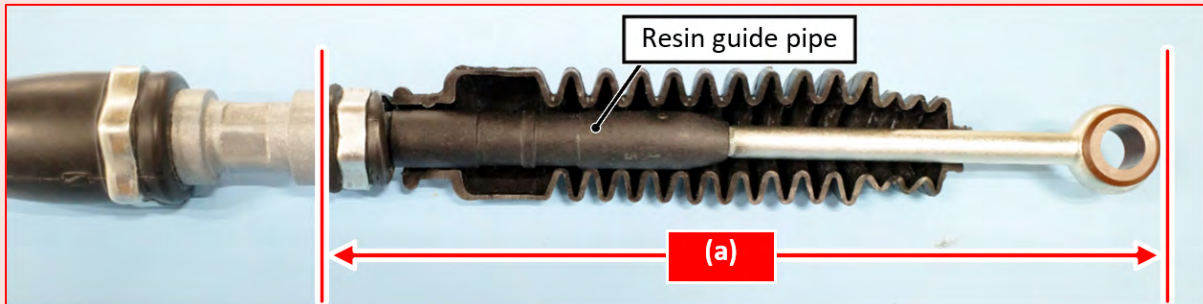

If the resin guide pipe is damaged, the inner cable can become slackened when operating the gear selector lever and the shifter arm become inoperative. As a result, the shift positions of the gear selector lever and the inhibitor switch do not match, causing malfunctions such as an engine no crank/no start condition.

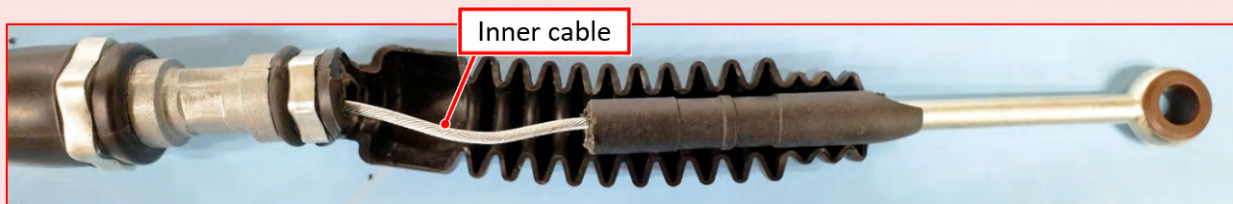

Due to the resin guide pipe and the inner cable being unable to be seen, **CAREFULLY** remove and install the gear selector cable.

STEP 15: Disconnect the inhibitor switch electrical connector. Remove the two mounting bolts for the inhibitor switch.

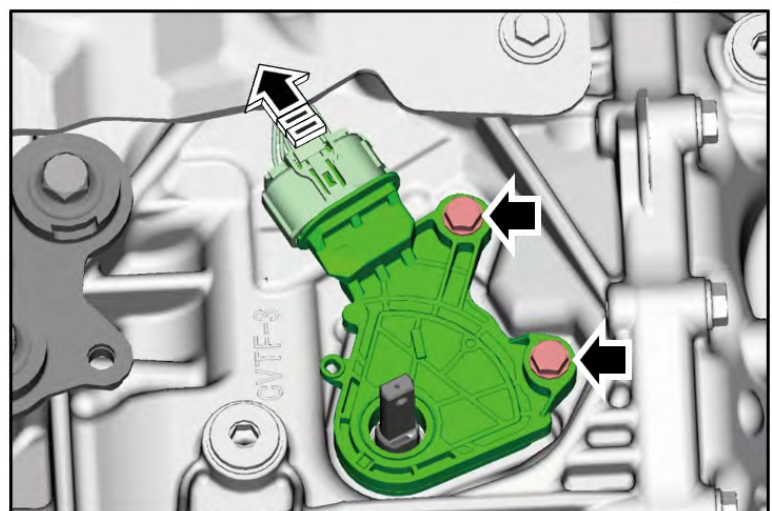

Continued...

STEP 16: Remove and discard the original inhibitor switch.

TIP: The inhibitor switch may be difficult to separate from the shaft. Slightly rocking the switch back and forth can help make removal easier if this occurs.

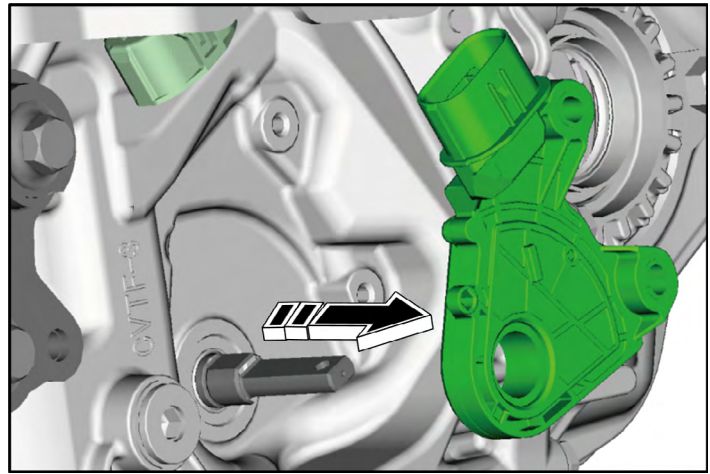

STEP 17: Install the new inhibitor switch. Maintain proper alignment with the shifter arm shaft. Refer to Work Tips Video at 01:33.

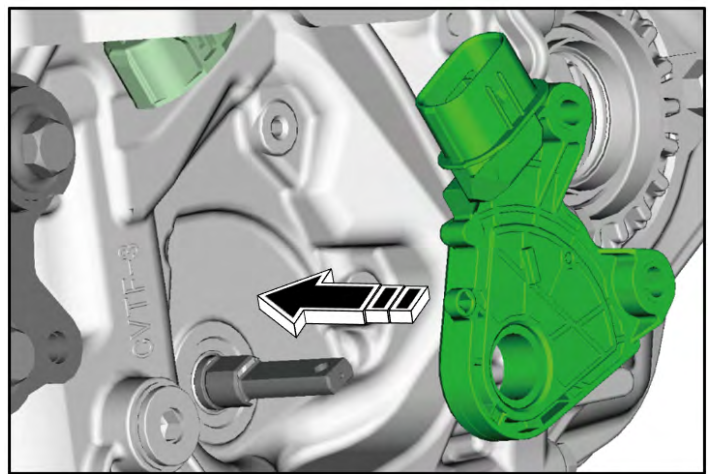

STEP 18: Connect the electrical connector. Install the two mounting bolts hand tight only. The bolts will be torqued after a final adjustment is made.

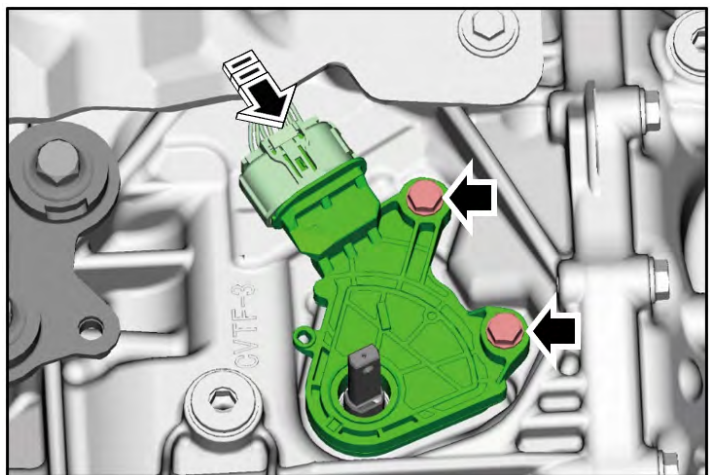

Continued...

STEP 19: Slightly pull the gear selector cable toward the rear of the vehicle and install the shifter arm onto the shaft.

CAUTION: DO NOT apply excessive pressure to part (a) of the gear selector cable shown below.

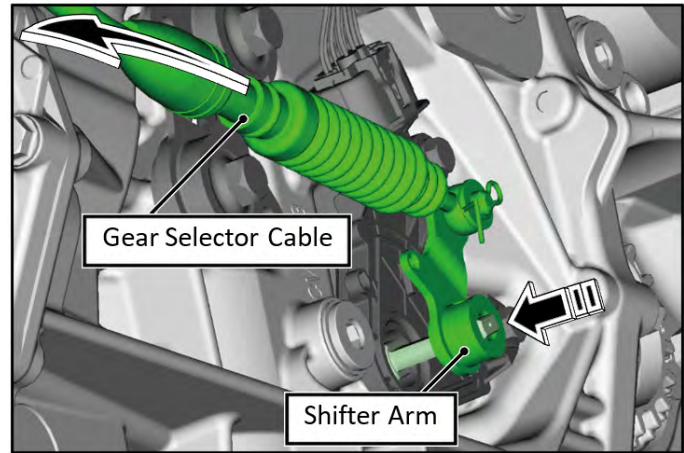
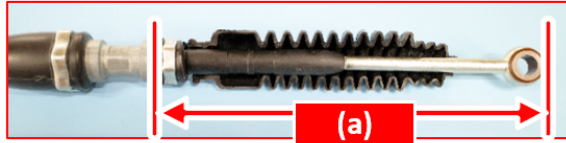

STEP 20: Install the cable bracket using the alignment marks made in Step 13. Torque the mounting bolts to 18Nm (13ft-lbs.).

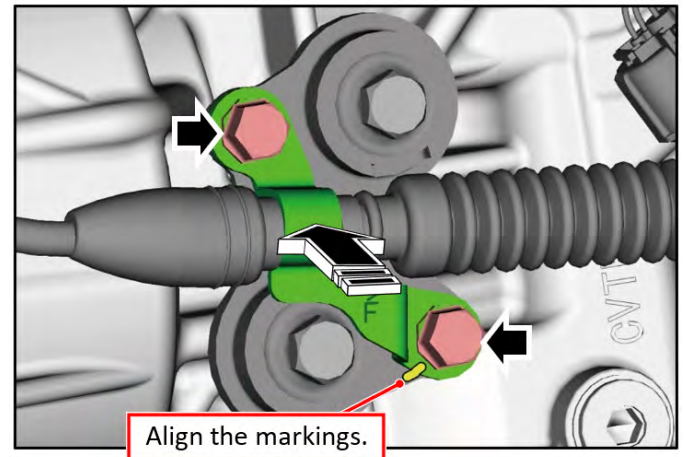

CAUTION: DO NOT install the cable bracket in the opposite position. Doing so will damage the gear selector cable.

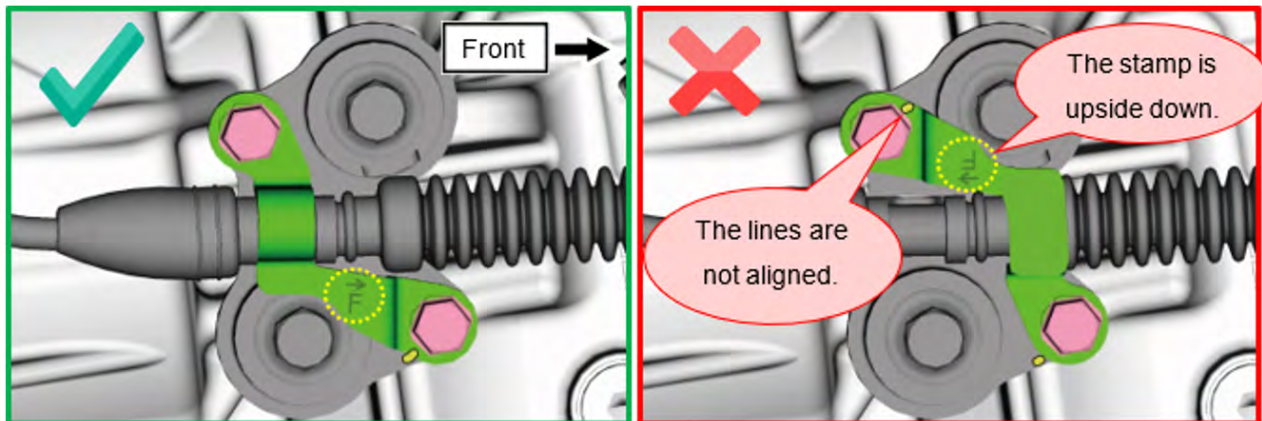

Continued...

STEP 21: Align the shifter arm hole and the shaft hole.

TIP: Inserting a bolt (M5x10mm) can help prevent any misalignment of the holes. The bolt can be secured with masking tape to prevent the bolt from falling out during pin installation.

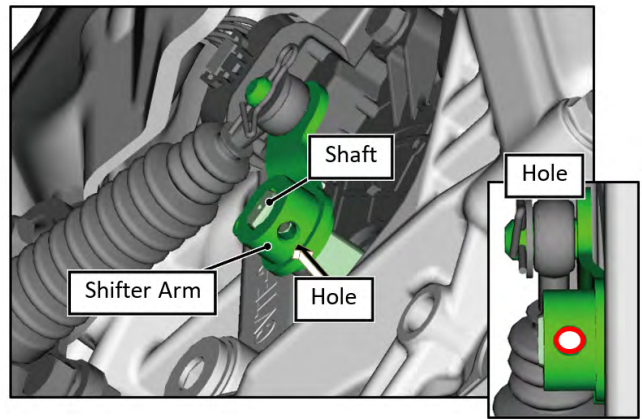
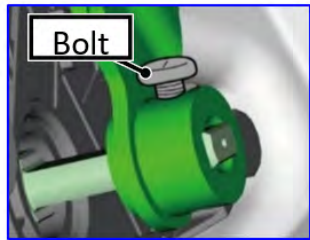

STEP 22: Prepare the new spring pin by securing it to the tip of a 5mm punch using masking tape or a piece of rubber tubing.

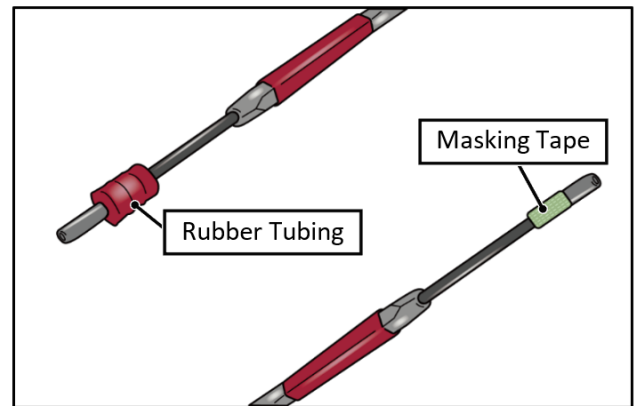

STEP 23: Install the new spring using a hammer. The spring is completely installed when the pin protrusion is equal on both sides.

CAUTION: Take particular care to not misalign the shifter arm and shaft holes during installation. **DO NOT** hit the surrounding components with the hammer.

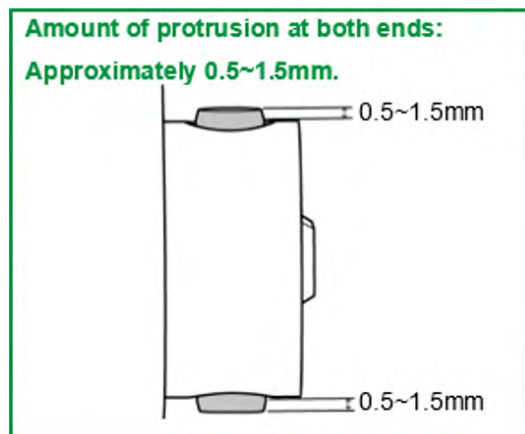
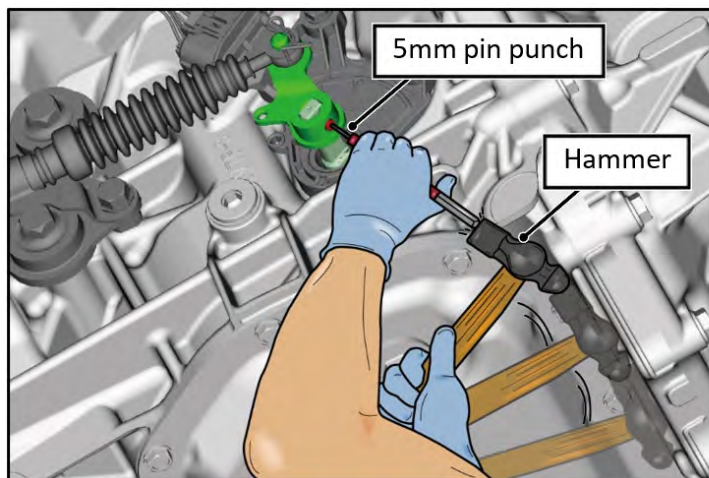

Continued...

STEP 24: Remove the masking tape from the gear selector cable.

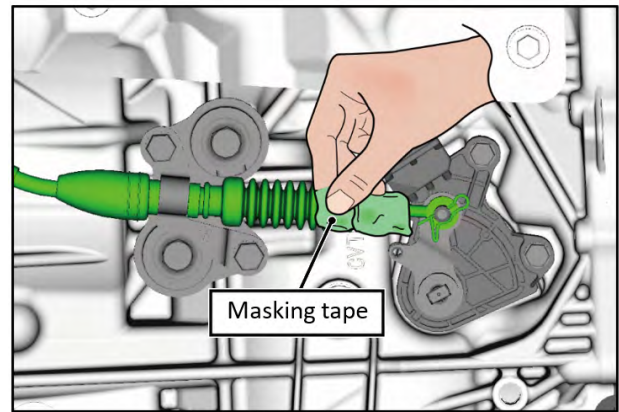

STEP 25: Align the shifter arm hole and the inhibitor switch hole and insert SST 499267300 or a 4mm punch. Tighten the two inhibitor switch mounting bolts to 5Nm (4 ft.-lbs. or 44 inch.-lbs.). The tool or punch can then be removed.

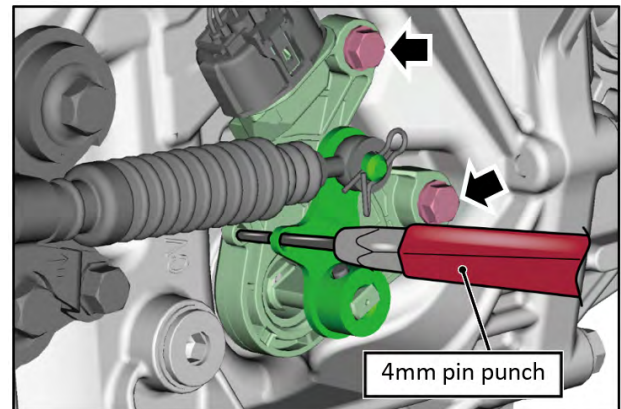

STEP 26: Lower the vehicle as per the lift manufacturer's instructions.

STEP 27: Reconnect the negative battery cable to the battery sensor. Torque to 7.5Nm (5.5ft.-lbs. or 66inch.-lbs.) while supporting the sensor with the other hand as outlined in the applicable Service Manual under: STARTING/CHARGING SYSTEMS > Battery Sensor.

STEP 28: Engage the electronic parking brake and perform the following function tests.

NOTE: If any of the following function tests results indicate improper operation, repeat the alignment procedure outlined in Step 25 followed by the function tests below.

- A. With the ignition on, depress the brake pedal and move the gear selector to all positions while confirming the gear indicated positions on the combination meter match.
- B. Confirm the illumination on the gear selector is functioning properly in all shift positions even if the selector is rocked back and forth in each.
- C. Confirm the engine can be started in both the Park and Neutral positions, even if the selector is pulled (in Park) or pushed (in Neutral) toward Reverse without pressing the select lever button.
- D. Without depressing the brake, apply slight pressure to the gear selector in all gears. Confirm the gear selection cannot be changed without depressing the brake, with the exception of Drive and Neutral. Confirm the gear selector will not move from Park using only the select lever button.
- E. Confirm the gear selector has smooth operation and is not binding in anyway.

Continued...

CALIFORNIA “VEHICLE EMISSION RECALL - PROOF OF CORRECTION” CERTIFICATE

The California Air Resources Board and the Department of Motor Vehicles Registration/Recall Program requires that all emission related Recall/Campaign or Service Program repairs be completed before a vehicle registration is renewed. Please provide owners of vehicles registered in the state of California a completed “Vehicle Emission Recall - Proof of Correction” certificate. Vehicle owners should be advised to retain this certificate because the California Department of Motor Vehicles may require they provide proof this service program repair has been completed. Additional certificates are available through normal parts ordering channels using part number MSA6P1301. Quantity 1 = 1 booklet of 50 certificates.

SERVICE PROGRAM IDENTIFICATION LABEL:

Type or print the necessary information on a Campaign Identification Label. The completed label should be attached to the vehicle’s upper radiator support. Additional labels are available through normal parts ordering channels. The part number is **MSA6P1302**, which comes as one sheet of 20 labels.

Part Number	Applicability	Description	Order Quantity
MSA6P1302	All Models	Campaign Completion Labels (contains one sheet of 20 labels)	1

Continued...

CLAIM REIMBURSEMENT AND ENTRY PROCEDURES:

Credit to perform this recall will be based on properly completed repair order information. Retailers may submit claims through Subarunet.com.

Labor Description	Labor Operation #	Labor Time	Fail Code
INHIBITOR SWITCH R&R	A103-791	0.6H	WRQ-23

NOTE: Up to 50 cents can be claimed in sublet for materials used.

IMPORTANT REMINDERS:

- SOA strongly discourages the printing and/or local storage of service information as previously released information and electronic publications may be updated at any time.
- Always check for any open recalls or campaigns anytime a vehicle is in for servicing.
- Always refer to STIS for the latest service information before performing any repairs.

Continued...

IMPORTANT SAFETY RECALL
This notice applies to the VIN identified in the address section printed below



Subaru Safety Recall WRQ-23
NHTSA ID 23V-755
January 2024

Dear Subaru Owner:

This notice is sent to you in accordance with the National Traffic and Motor Vehicle Safety Act.

SUBARU OF AMERICA, INC. has decided that a defect, which relates to motor vehicle safety, exists in certain 2021 model year Crosstrek vehicles, certain 2022 model year Forester, and certain 2021-2023 model year Legacy and Outback vehicles.

You received this notice because our records indicate that you currently own one of these vehicles.

DESCRIPTION OF THE DEFECT AND SAFETY RISK

The inhibitor switch on your vehicle may have been manufactured with an insufficient weld between the switch stator and cover which may allow water intrusion.

Over time, moisture intrusion may cause the inhibitor switch to become inoperative. An inoperative inhibitor switch may result in the backup lamps not illuminating when in reverse gear, the rear-view monitor not displaying, the transmission gear select indicator in the instrument panel not being displayed, or inability to start the engine, each of which increases the risk of a crash.

WHAT SUBARU WILL DO

Subaru will replace the inhibitor switch with a new one at no cost to you.

WHAT YOU SHOULD DO

Please contact your Subaru retailer (dealer) immediately for an appointment to have this repair performed, at no cost to you.

If you notice that the backup lamps are not illuminating when in reverse gear, the rear-view monitor is not displaying, the transmission gear select indicator in the instrument panel is not being displayed, or you cannot start the engine in your vehicle, please have your vehicle inspected by your Subaru retailer immediately.

Continued...

HOW LONG WILL THE REPAIR TAKE?

The time required to perform this repair is less than 40 minutes. However, it may be necessary to leave your vehicle for a longer period of time on the day of your scheduled appointment to allow your Subaru retailer flexibility in scheduling.

CALIFORNIA REGISTERED OWNERS

The California Air Resources Board requires that emission-related campaigns be completed prior to California's vehicle registration renewal process; without this repair, you will not be able to register your vehicle during your next annual registration. Upon completion of this campaign, your California dealer will complete and provide you a "Proof of Correction Certificate." If required, present the certificate to the California Department of Motor Vehicles (the "DMV") when renewing your California registration as proof of campaign completion. If the DMV does not request the certificate, we recommend that you keep it for your records.

In addition, the State of California requires that every vehicle must pass an emission test (SMOG Check) every two years and before it is sold. Without the service we are providing at no charge, your vehicle may not pass this test.

OWNER INFORMATION

Government regulations require that recall notifications be sent to the last known owner of record. That information is based primarily on state registration and title data. If you are a lessor of this vehicle, federal regulations require you to forward this notice to your lessee within ten days.

If you have moved or sold your vehicle, please go to <https://www.subaru.com/support/customer-support.html> to send us your information.

IF YOU HAVE PREVIOUSLY PAID FOR A REPAIR

If you have already paid for repairs associated with this condition, you may be eligible for reimbursement. Reimbursement consideration will be based on the amount an authorized Subaru retailer in your area would charge for the same repair.

Please send the original service repair order, which has the name of the repair facility, date of repair, mileage at the time of repair, complete 17-digit vehicle identification number (VIN), and your name, with correct mailing address and telephone number to the address listed below.

Subaru of America, Inc.

Customer Advocacy Department, Attention: WRQ-23 Recall

P.O. Box 9103, Camden, NJ 08101-9877

Please send original receipts only and retain a photocopy for your records. Please be assured that we will attempt to process your reimbursement request as quickly as possible, but it may take up to 60 days for this process to be completed.

Continued...

IF YOU NEED FURTHER ASSISTANCE:

To locate the nearest Subaru retailer, you can access our website at www.subaru.com and select 'Find a Retailer.'

For additional information, please go to: <http://www.wrq23.service-campaign.com>.

If you need additional assistance, please contact us directly:

- By e-mail: Go to www.subaru.com and select "Customer Support"
- By telephone: 1-844-373-6614
Monday through Friday between 8:00 a.m. and 7:00 p.m. ET
- By U.S. Postal mail: Write us at Subaru of America, Inc.
Attn: Customer Advocacy Department
P.O. Box 9103, Camden, NJ 08101-9877

To subscribe to the NHTSA Recall Notification email System, please go to: <https://www-odi.nhtsa.dot.gov/nhtsa/subscriptions>.

Please contact us immediately if the Subaru retailer fails or is unable to make the necessary repairs free of charge.

You may also contact the Administrator, National Highway Traffic Safety Administration (NHTSA), 1200 New Jersey Ave., SE, Washington, DC 20590 or call the toll-free Vehicle Safety Hotline at 1-888-327-4236 (TTY: 1-800-424-9153) or go to <http://www.NHTSA.gov> if you believe the Subaru retailer has failed or is unable to remedy your vehicle without charge within a reasonable amount of time.

Your continued satisfaction with your Subaru is important to us. Please understand that we have taken this action in the interest of your safety and your vehicle's proper operation. We sincerely apologize for any inconvenience this matter may cause and urge you to schedule an appointment as soon as possible.

Sincerely,

Subaru of America, Inc.

A subsidiary of SUBARU CORPORATION