

**ATTENTION:**

GENERAL MANAGER

PARTS MANAGER

CLAIMS PERSONNEL

SERVICE MANAGER

IMPORTANT - All Service Personnel Should Read and Initial in the boxes provided, right.

© 2019 Subaru of America, Inc. All rights reserved.



QUALITY DRIVEN® SERVICE

## PRODUCT CAMPAIGN BULLETIN

**APPLICABILITY:** 2019MY Ascent

**SUBJECT:** CVT Chain Slip

**NUMBER:** WUV-07

**NHTSA ID:** 19V855

**DATE:** 12/05/19

**REVISED:** 07/05/22

### UPDATE July 5, 2022:

- This recall (WUV-07) has been expired and superseded to the WRK-21 recall.
- On July 5, 2022, any open WUV-07 recall coverage was expired in SOA's system.
- All vehicles affected by the WUV-07 recall must return to complete the WRK-21 recall repair, even if the WUV-07 recall repair was completed.
- Please refer to the WRK-21 Product Campaign Bulletin for more detail.

### INTRODUCTION:

Subaru of America, Inc. (Subaru) is recalling certain 2019 model year Ascent vehicles in which mid-joint of the transmission hydraulic sensor harness was made with dissimilar materials (tinplate and copper) which may cause an oxide film to form. If an oxide film forms, the electrical resistance may increase, potentially causing an incorrect measurement of the hydraulic pressure. If the fluid pressure is measured higher than its actual value, the Transmission Control Unit (TCU) programming was not robust enough to compensate for variation and would instruct the valve to lower the hydraulic pressure, thus potentially reducing the tension on the drive chain. Customers may experience irregular noise and/or vibration while driving, and/or warning lamp illumination. A total of 76,842 U.S. vehicles will be affected by this recall.

### AFFECTED VEHICLES:

Model Year	Carline	Production Date Range	Affected VIN Range
2019	Ascent	February 22, 2018 – May 7, 2019	K3400001– K3481557

Not all vehicles in the production range listed above are affected by this recall. Coverage must be confirmed by using the Vehicle Coverage Inquiry function on [Subarunet.com](http://Subarunet.com) prior to repair. This information is now available.

**CAUTION: VEHICLE SERVICING PERFORMED BY UNTRAINED PERSONS COULD RESULT IN SERIOUS INJURY TO THOSE PERSONS OR TO OTHERS.**

Subaru Service Bulletins are intended for use by professional technicians ONLY. They are written to inform those technicians of conditions that may occur in some vehicles, or to provide information that could assist in the proper servicing of the vehicle. Properly trained technicians have the equipment, tools, safety instructions, and know-how to do the job correctly and safely. If a condition is described, DO NOT assume that this Service Bulletin applies to your vehicle, or that your vehicle will have that condition.

**Subaru of America, Inc. is ISO 14001 Compliant**

ISO 14001 is the international standard for excellence in Environmental Management Systems. Please recycle or dispose of automotive products in a manner that is friendly to our environment and in accordance with all local, state and federal laws and regulations.

*Continued...*

## REASON FOR THIS RECALL:

The transmission hydraulic sensor may incorrectly measure the hydraulic fluid pressure. If the fluid pressure is measured higher than its actual value, the hydraulic pressure will be reduced. If this occurs, the drive chain may not have the proper tension.

## SAFETY RISK:

Customers may be able to recognize this condition from irregular noise and/or vibration while driving, and/or warning lamp illumination. Continuing to operate a vehicle experiencing this condition may ultimately result in loss of power while driving, increasing the risk of a crash.

## DESCRIPTION OF THE REMEDY:

Subaru retailers will reprogram the TCU. Following the TCU reprogramming and after a drive test, DTC codes will be inspected and if certain DTCs are present, the hydraulic sensor harness will be replaced with an updated part. If vehicles are confirmed to have experienced, or are currently experiencing low drive chain tension, the transmission assembly will be replaced.

## OWNER NOTIFICATION:

Subaru will notify all potentially affected vehicle owners by first class mail within 60 days. Owners with a valid email address on file with Subaru will also be notified by email.

## RETAILER RESPONSIBILITY:

***Please be advised that it is a violation of Federal law for a dealer to deliver a new motor vehicle covered by a recall under a sale or lease until the defect is remedied. Therefore, any Authorized Subaru Retailer failing to perform the applicable service procedures to correct all affected vehicles in their inventory prior to the vehicle being placed in service may be subject to civil penalties of up to \$21,000 per violation (i.e., for each vehicle), as provided in 49 CFR §578.6 and will also be in breach of the Subaru Dealer Agreement.***

Any vehicles listed in any recall/campaign that are in retailer stock must be:

- Immediately identified.
- Tagged or otherwise marked to prevent their delivery or use prior to repair.
- Repaired in accordance with the repair procedures outlined in the Product Campaign Bulletin

Retailers are to promptly follow the applicable service procedures, to correct all affected vehicles in their inventory (used, demo & SSLP). Additionally, whenever a vehicle subject to this recall is taken into retailer inventory necessary steps should be taken to ensure the recall correction has been made before selling or releasing the vehicle.

***Continued...***

## SERVICE PROCEDURE:

**REMINDER:** Customer satisfaction and retention starts with performing quality repairs.

### Flow Chart:

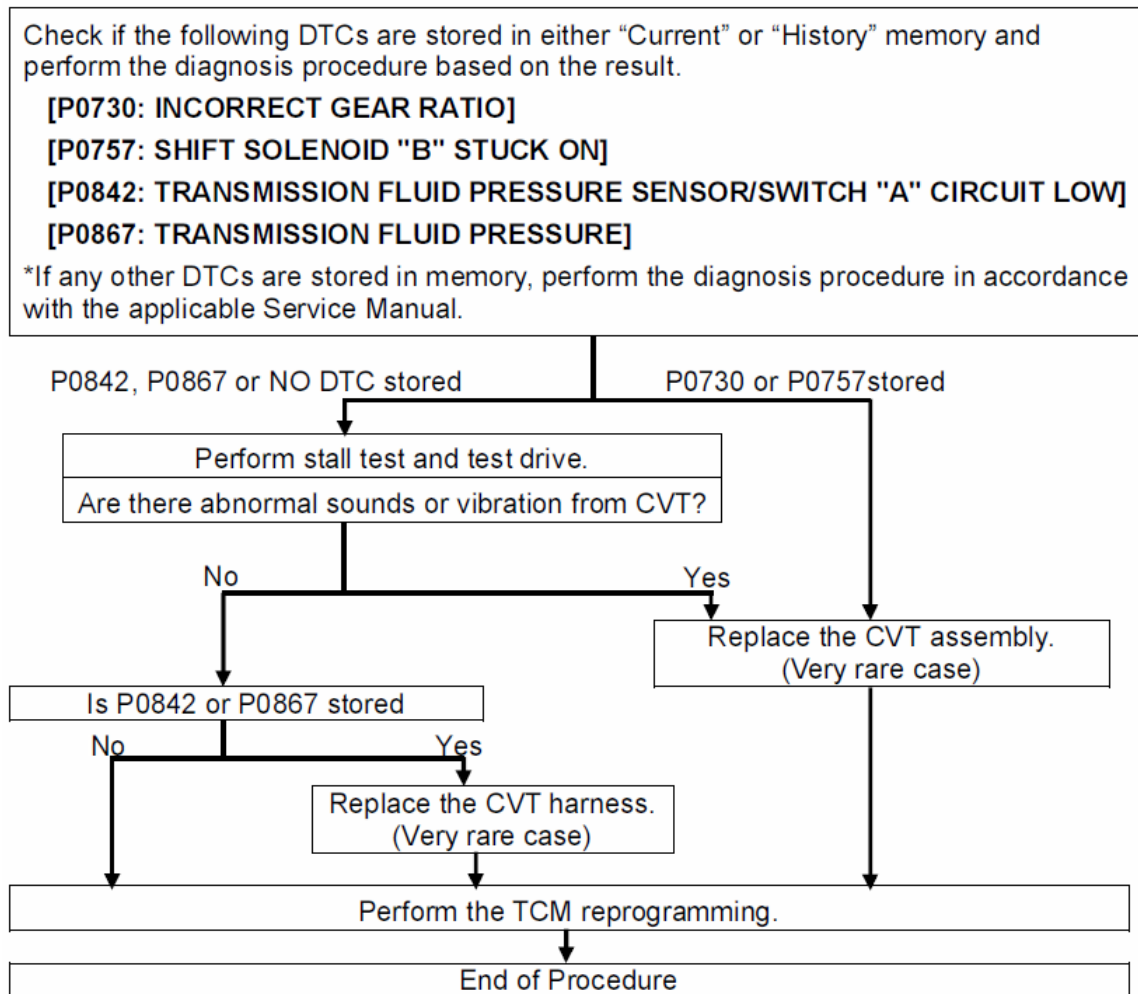

## PARTS INFORMATION:

In a **VERY RARE** case where the CVT assembly or CVT wiring harness replacement is determined to be necessary, the parts ordering information is below:

- Transmission Harness: **24031AA851**

**IMPORTANT:** NEVER use old harness p.n. 24031AA850 for this repair. Any remaining inventory of this p.n. **must** be scrapped.

- CVT Assembly: **31000AK130** for Ascent **WITH** auxiliary CVTF Cooler
- CVT Assembly: **31000AK140** for Ascent **WITHOUT** auxiliary CVTF Cooler

*Continued...*

**Step 1-** Connect the SSM4 and perform a DTC Check to see if any of the following DTCs are stored in either the TCM “Current” or “History” memory.

[P0730: INCORRECT GEAR RATIO]

[P0757: SHIFT SOLENOID "B" STUCK ON]

[P0842: TRANSMISSION FLUID PRESSURE SENSOR/SWITCH "A" CIRCUIT LOW]

[P0867: TRANSMISSION FLUID PRESSURE]

\*If other DTCs are stored in memory, perform the diagnosis procedure in accordance with the applicable service manual.

- DTC **P0842**, **P0867** or **NO DTCs** stored: Proceed to **Step 2** and check for any abnormal sounds or vibration while performing a stall test and test drive. See applicable Service Manual for stall test procedure.
- DTC **P0730** or **P0757** stored (**very rare** case): Replace the CVT assembly and flush the CVTF cooler following the procedures in the applicable Service Manual. When complete, clear the TCM of any DTCs and proceed to **Step 4**.

**Step 2-** Perform a stall test and test drive the vehicle to check for any abnormal sounds or vibration.

**IMPORTANT NOTE:** A brief “chirp” -type sound heard when engaging Reverse or Drive is a non-detrimental operating characteristic of this model CVT.

- No abnormal sounds or vibration detected during the stall test and test drive: proceed to **Step 3**.
- Abnormal sounds or vibration detected: replace the CVT assembly following the procedure in the applicable Service Manual including CVTF cooler flushing. When complete, proceed to **Step 4**.

**Step 3-** Was DTC **P0842** or **P0867** stored in the TCM while performing **Step 1** above?

- No DTCs stored: proceed to **Step 4** and reprogram the TCM.
- **P0842** or **P0867** is stored (**very rare** case): replace the CVT harness. See the applicable Service Manual for the CVT harness replacement procedures. For more experienced Subaru Technicians, an alternative procedure is provided in the **Harness Replacement Tips** section below. When harness replacement is complete, clear the TCM memory of any codes, proceed to **Step 4**.

**Step 4-** Reprogram the TCM following the normal FlashWrite procedure and perform the CVT Relearn procedure supplied in the applicable Service Manual.

**IMPORTANT CAUTIONS:**

- The PAK file is different for each car model.
- Turn off all the electrical components to prevent the vehicle battery from going dead.
- The Transmission Control Module may be damaged if the reprogramming is interrupted due to the PC battery going dead during the reprogramming, etc.
- Supply power to the PC at all times during reprogramming.
- Never turn off the PC power before reprogramming is completed.
- **NEVER** disconnect any of the cables (power supply, DLC, USB cable) during reprogramming.

*Continued...*

## PACK FILE APPLICABILITY:

Model	PAK File Name	New TCM Part Number	Old TCM Part Numbers	Decryption Keyword	New TCM CID Number
Ascent <b>WITH</b> Auxiliary CVTF Cooler	30919AF99C.pak	30919AF99C	30919AF99A, 99B	06F4F4FF	R8FEF700
Ascent <b>W/OUT</b> Auxiliary CVTF Cooler	30919AF98C.pak	30919AF98C	30919AF98A, 98B	2DAA4E53	R8FEE700

Subaru of America, Inc. (SOA) highly recommends connecting either the Subaru Midtronics DCA-8000 Dynamic Diagnostic Charging System or the Subaru Midtronics GR8-100 Diagnostic Battery Charger to the vehicle and utilizing the Power Supply Mode feature anytime a vehicle control module is being reprogrammed.

Once the Midtronics charger is connected to the vehicle, **if the battery is fully charged**, it takes less than three (3) minutes to boot-up the charger, select the Power Supply Mode, and have the battery voltage stabilized and ready for reprogramming.

### NOTES:

- For instructions on using the power supply mode, reference the applicable User Manual for the Midtronics DCA-8000 Dynamic Diagnostic Charging System and the Midtronics GR8-1100 Diagnostic Battery Charger on STIS.
- Confirm all electrical loads such as lights, audio, HVAC, seat heaters, and rear defroster are all switched OFF before setting up the charger for Power Supply Mode.
- Select the correct battery type (Flooded, EFB, Gel, AGM or AGM Spiral).
- Input the CCA which matches the vehicle's battery. NOTE: OE and replacement batteries have different CCA ratings. Always confirm the battery's CCA rating before proceeding.
- If using a DCA-8000 Dynamic Diagnostic Charging System, set the power supply voltage to 13.5 volts.
- DO NOT connect the DST-i or SDI until the Power Supply mode function has completed its battery test mode and the Charging Voltage has dropped to and shows a steady 13.5 Volts on the display.
- Once Power Supply Mode reaches a steady 13.5 volts, connect the DST-i or SDI to the OBD connector and proceed with initiating the normal FlashWrite reprogramming process.
- Amperage will fluctuate based upon the vehicle's demand for power. NOTE: If the voltage rises beyond 14V while programming is in process, the procedure will abort. This can indicate a need to test or charge the vehicle battery before any further attempt at programming is made.

### VERY IMPORTANT:

This information is applicable to the Subaru Midtronics DCA-8000 Dynamic Diagnostic Charging System and the Subaru Midtronics GR8-1100 Diagnostic Battery Charger **ONLY**. It does not apply to any other brand / type of "generic" battery charger whatsoever. **ONLY** the DCA-8000 and the GR8-1100 and their Power Supply Mode feature have been tested and approved by SOA.

**REMINDER:** If the DCA-8000 or GR8-1100 indicates the vehicle's battery must be charged, charge it fully using the DCA-8000 or GR8-1100 before proceeding to reprogram the vehicle using the Power Supply Mode.

*Continued...*

**NOTE:** Control module failures resulting from battery discharge during reprogramming are not a matter for warranty. Should any DTCs reset after the reprogramming update is performed, diagnose per the procedure outlined in the applicable Service Manual.

**IMPORTANT:** The **NEW** Calibration Identification number (CID) for any newly-installed programming (as confirmed from the actual control module **AFTER** installation) should always be documented on the repair order.

**NOTE:** The pack file listings provided in this bulletin are the latest available at the time of publishing. Updates are often released thereafter without revision to the original bulletin. For this reason, it is critical to always have the latest version of Select Monitor software installed on your system. You can confirm if a later version is available by entering the CID listed in this bulletin into FlashWrite. If a newer CID is shown as available in FlashWrite, reprogram using that file.

**Step 5- IMPORTANT:** APPLICABLE ONLY AFTER REPLACING THE CVT ASSEMBLY OR THE TRANSMISSION HARNESS: Using the SSM4, perform the AT Learning procedure following the procedure outlined in the applicable Service Manual.

#### **HARNESS REPLACEMENT TIPS:**

The following is being presented as an allowable alternative procedure for more experienced Subaru trained Technicians. The CVT wiring harness can be replaced **without** removal of the CVT assembly using the procedure below:

- Remove the battery ground terminal, intercooler and the pitching stopper following the procedures in the applicable Service Manual.
- Disconnect the CVT harness bracket, the ground terminal and the primary speed sensor harness connector as shown in the photos below.

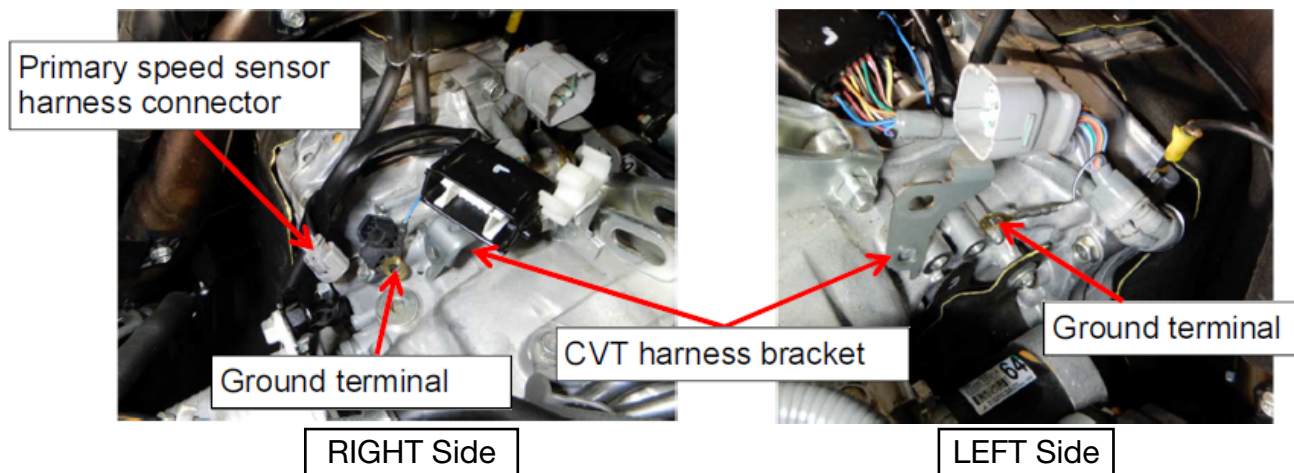

- Raise the vehicle. Remove the center exhaust pipe (rear), selector cable, CVT oil pan, drain the CVTF and remove the propeller shaft following the procedures in the applicable Service Manual.
- Set a transmission stand in place as shown below and remove the transmission rear cross member. **CAUTION: NEVER** place any stand or jack on the transmission pan as damage will occur which could lead to CVT failure.

*Continued...*



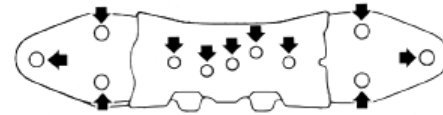

- Lower the transmission stand by **NO MORE THAN 75mm**. Remove the 6 bolts securing the transmission cover then **CAREFULLY** slide cover toward the rear of the vehicle.

**CAUTION:** Never lower the transmission stand by more than 75mm or the A/C hose may be damaged.

**NOTE:** TAKE YOUR TIME when removing the transmission cover while being careful to not catch the inside of it on the external components of the CVT.

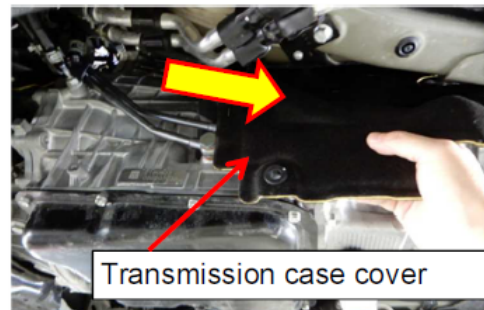
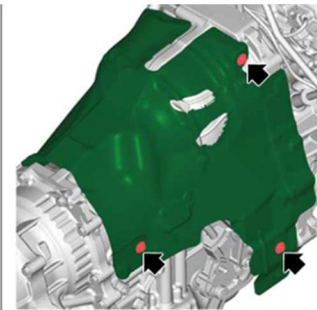
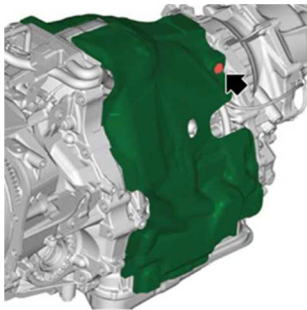

- **CAREFULLY** remove the harness connectors and retaining clips shown below and remove the CVT harness from the CVT housing.

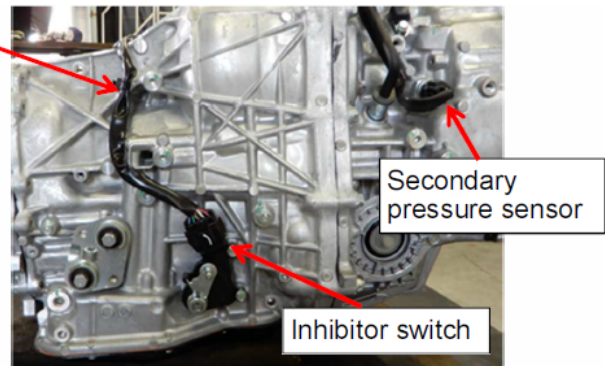
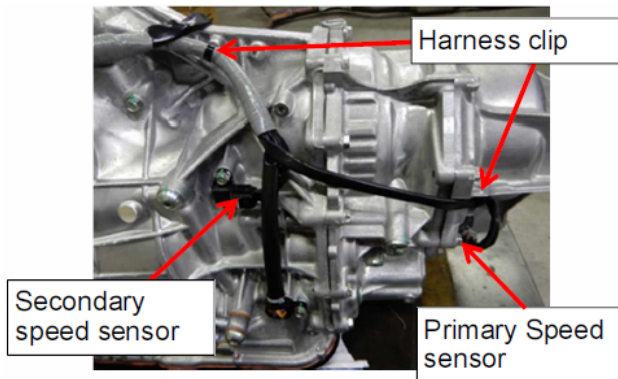

- **CAREFULLY** remove the control valve body **closely** following the procedure in the applicable Service Manual and remove the CVT harness.
- Install the new transmission harness, reassemble in reverse order of disassembly.
- When complete, clear the TCM memory of any DTCs, reprogram the TCM following the normal FlashWrite procedure.

*Continued...*

**SERVICE PROGRAM IDENTIFICATION LABEL:**

Type or print the necessary information on a Campaign Identification Label. The completed label should be attached to the vehicle’s upper radiator support. Additional labels are available through normal parts ordering channels. The part number is **MSA6P1302**, which comes as one sheet of 20 labels.

Part Number	Applicability	Description	Order Quantity
MSA6P1302	All Models	Campaign Completion Labels (contains one sheet of 20 labels)	1

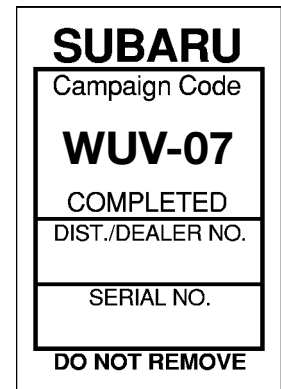

**CLAIM REIMBURSEMENT AND ENTRY PROCEDURES:**

Credit to perform this recall will be based on properly completed repair order information. Retailers may submit claims through [Subarunet.com](http://Subarunet.com).

Labor Description	Labor Operation #	Labor Time	Fail Code
TCM REPROGRAMMING, Includes: DTC Check, Stall Test and Test Drive	A186-701	0.9	WUV-07
CVT REPLACEMENT, Includes: TCM Reprogramming, DTC Check, Stall Test, Test Drive, CVTF Cooler Flush and perform AT Learning procedure	A130-341	5.6	
CVT HARNESS REPLACEMENT, Includes: TCM Reprogramming, DTC Check, Stall Test, Test Drive, CVTF Cooler Flush and perform AT Learning procedure	A130-342	6.8	

**IMPORTANT REMINDERS:**

- SOA strongly discourages the printing and/or local storage of service information as previously released information and electronic publications may be updated at any time.
- Always check for any open recalls or campaigns anytime a vehicle is in for servicing.
- Always refer to STIS for the latest service information before performing any repairs.

*Continued...*



**URGENT**  
**IMPORTANT SAFETY RECALL**  
This notice applies to the VIN below



**Subaru Safety Recall WUV-07**  
**NHTSA Recall ID 19V-855**  
**January 2020**

**Dear Subaru Owner:**

This notice is sent to you in accordance with the National Traffic and Motor Vehicle Safety Act.

SUBARU OF AMERICA, INC. has decided that a defect, which relates to motor vehicle safety, exists in certain 2019 model year Ascent vehicles.

You received this notice because our records indicate that you currently own one of these vehicles.

**REASON FOR THIS SAFETY RECALL**

The transmission hydraulic sensor in your vehicle may incorrectly measure the hydraulic fluid pressure. If the fluid pressure is measured higher than its actual value, the hydraulic pressure will be reduced. If this occurs, the drive chain may not have the proper tension resulting in “chain slip”. You may be able to recognize this condition from irregular noise and/or vibration while driving, and/or warning lamp illumination.

**SAFETY RISK**

Continuing to operate a vehicle experiencing this condition may ultimately result in loss of power while driving, increasing the risk of a crash.

**WHAT SUBARU WILL DO**

Subaru will reprogram the transmission control unit (TCU) at no cost to you. Following the TCU reprogramming and after a drive test, diagnostic trouble codes (DTC codes) will be inspected and if certain DTCs are present, the hydraulic sensor harness will be replaced with an updated part at no cost to you. If vehicles are confirmed to have experienced, or are currently experiencing low drive chain tension, the transmission assembly will be replaced. This replacement will be at no cost to you.

Additionally, in cases where the CVT transmission assembly is not replaced as a result of this recall, Subaru will extend the New Car Powertrain Limited Warranty as it applies to your CVT and the chain slip condition. The extended coverage period will run from the vehicle’s original warranty start date and end after ten (10) years or one hundred thousand (100,000) miles, whichever comes first. The extension will apply only after you have had this recall repair completed. All other terms of the New Car Powertrain Limited Warranty will continue to apply.

***What You Should Do***

You should contact any authorized Subaru retailer (dealer) for an appointment to have this safety recall repair performed, at no cost to you.

a subsidiary of Subaru Corporation

***Continued...***

## HOW LONG WILL THE REPAIR TAKE?

The time required for the TCU reprogramming and subsequent test drive and DTC inspection is approximately 1 hour. However, in certain rare cases, if the vehicle requires replacement of the hydraulic sensor harness or if the transmission assembly needs to be replaced, the time required to complete these repairs could extend to approximately 7 hours. Your retailer can provide you with a better estimate of the overall time for this service visit, as it may be necessary to make your vehicle available for a longer period of time.

For your convenience, your retailer may provide you with a loaner or rental vehicle, at no cost to you, until the repair is complete.

## CALIFORNIA REGISTERED OWNERS

The California Air Resources Board requires that emission related campaigns be completed prior to California's vehicle registration renewal process; without this repair, you will not be able to register your vehicle during your next annual registration. Upon completion of this campaign, your California dealer will complete and provide you a "Proof of Correction Certificate." If required, present the certificate to the California Department of Motor Vehicles (the "DMV") when renewing your California registration as proof of campaign completion. If the DMV does not request the certificate, we recommend that you keep it for your records.

In addition, the State of California requires that every vehicle must pass an emission test (SMOG Check) every two years and before it is sold. **Without the repair we are providing at no charge, your vehicle may not pass this test.**

## OWNER INFORMATION

Government regulations require that recall notifications be sent to the last known owner of record. That information is based primarily on state registration and title data. If you are a lessor of this vehicle, federal regulations require you to forward this notice to your lessee within ten days.

If you have moved or sold your vehicle, please update this information online at [www.subaru.com](http://www.subaru.com), select 'Customer Support,' then select 'Address Update' or 'Ownership Update' from the "Quick Links" menu.

## IF YOU HAVE PREVIOUSLY PAID FOR A REPAIR

If you have already paid for repairs associated with this condition, you may be eligible for reimbursement. Reimbursement consideration will be based on the amount an authorized Subaru retailer in your area would charge for the same repair.

Please send the original service repair order, which has the name of the repair facility, date of repair, mileage at the time of repair, complete 17-digit vehicle identification number (VIN), and your name, with correct mailing address and telephone number to the address listed below.

**Subaru of America, Inc.**

**Customer-Retailer Services Department, Attention: WUV-07 Recall**

**P.O. Box 9103, Camden, NJ 08101-9877**

Please send original receipts only and retain a photocopy for your records. Please be assured that we will attempt to process your reimbursement request as quickly as possible, but it may take up to 60 days for this process to be completed.

## IF YOU NEED FURTHER ASSISTANCE:

To locate the nearest Subaru retailer, you can access our website at [www.subaru.com](http://www.subaru.com) and select 'Find a Retailer.'

a subsidiary of Subaru Corporation

*Continued...*

For additional information, please go to: <http://www.wuv07.service-campaign.com>.

If you need additional assistance, please contact us directly:

- By e-mail: Go to [www.subaru.com](http://www.subaru.com) and select “Customer Support”
- By telephone: 1-844-373-6614

Monday through Friday between 8:00 a.m. and 7:00 p.m. ET

- By U.S. Postal mail: Write us at Subaru of America, Inc.  
Attn: Customer-Retailer Services Department  
P.O. Box 9103, Camden, NJ 08101-9877

To subscribe to the NHTSA Recall Notification email System, please go to: <https://www-odi.nhtsa.dot.gov/nhtsa/subscriptions>.

Please contact us immediately if the Subaru retailer fails or is unable to make the necessary repairs free of charge.

You may also contact the Administrator, National Highway Traffic Safety Administration (NHTSA), 1200 New Jersey Ave., SE, Washington, DC 20590 or call the toll-free Vehicle Safety Hotline at 1-888-327-4236 (TTY: 1-800-424-9153) or go to <http://www.safercar.gov> if you believe the Subaru retailer has failed or is unable to remedy your vehicle without charge within a reasonable amount of time.

Your continued satisfaction with your Subaru is important to us. Please understand that we have taken this action in the interest of your safety and your vehicle’s proper operation. We sincerely apologize for any inconvenience this matter may cause and urge you to schedule an appointment as soon as possible.

Sincerely,  
Subaru of America, Inc.

Notice to Lessors

*The lessor of a vehicle who receives this letter must provide a copy of it to the vehicle lessee(s) within 10 business days from receipt. The lessor must also keep a record of the lessee(s) to whom this letter is sent, the date sent, and the applicable vehicle identification number (VIN). (For the purposes of this section, a lessor means a person or entity that in the last twelve months prior to the date of this notification has been the owner, as referenced on the vehicle’s title, of any five or more leased vehicles. A leased vehicle is a vehicle leased to another person for a term of at least four months.)*

a subsidiary of Subaru Corporation