

ATTENTION:

- GENERAL MANAGER
- PARTS MANAGER
- CLAIMS PERSONNEL
- SERVICE MANAGER

IMPORTANT - All Service Personnel Should Read and Initial in the boxes provided, right.

© 2020 Subaru of America, Inc. All rights reserved.



QUALITY DRIVEN® SERVICE

PRODUCT CAMPAIGN BULLETIN

APPLICABILITY: 2019MY Legacy and Outback 2.5 and 3.6L
2019MY Impreza
2019MY Ascent

NUMBER: WRD-20R

DATE: 04/23/20

NHTSA: 20V-218

SUBJECT: Fuel Pump Impeller Failure

REVISED: 10/02/20

INTRODUCTION:

Subaru of America, Inc. (Subaru) is initiating a new safety recall for certain 2019 model year Ascent, Impreza, Legacy, and Outback vehicles in which the fuel pump may become inoperative.

DESCRIPTION OF THE DEFECT AND SAFETY RISK:

The affected vehicles may be equipped with a low pressure fuel pump which includes an impeller that was manufactured with a lower density. If the surface of the lower density impeller is exposed to solvent drying for longer periods of time, it may develop fine cracks. Those cracks may lead to excessive fuel absorption, resulting in impeller deformation. Over time, the impeller may become deformed enough to interfere with the body of the fuel pump, potentially causing the low pressure fuel pump to become inoperative.

If the low pressure fuel pump becomes inoperative, the check engine warning light or malfunction indicator light may illuminate, and/or the engine may run rough. In the worst case, an inoperative fuel pump may result in the engine stalling without the ability to restart the vehicle, increasing the risk of a crash.

AFFECTED VEHICLES:

A total of 188,207 U.S. vehicles will be affected by this recall, as listed below:

Model Year	Carline	Production Date Range	Affected Vehicle Count
2019	Ascent	June 26, 2018 - January 18, 2019	40,950
2019	Impreza	June 18, 2018 – February 25, 2019	40,797
2019	Legacy	June 29, 2018 – February 19, 2019	20,182
2019	Outback	June 29, 2018 – February 19, 2019	86,278

Not all vehicles in the production ranges listed above are affected by this recall. Coverage must be confirmed by using the Vehicle Coverage Inquiry function on Subarunet.com prior to repair. The status of this recall has been updated to “Open”.

CAUTION: VEHICLE SERVICING PERFORMED BY UNTRAINED PERSONS COULD RESULT IN SERIOUS INJURY TO THOSE PERSONS OR TO OTHERS.

Subaru Service Bulletins are intended for use by professional technicians ONLY. They are written to inform those technicians of conditions that may occur in some vehicles, or to provide information that could assist in the proper servicing of the vehicle. Properly trained technicians have the equipment, tools, safety instructions, and know-how to do the job correctly and safely. If a condition is described, DO NOT assume that this Service Bulletin applies to your vehicle, or that your vehicle will have that condition.

Subaru of America, Inc. is ISO 14001 Compliant

ISO 14001 is the international standard for excellence in Environmental Management Systems. Please recycle or dispose of automotive products in a manner that is friendly to our environment and in accordance with all local, state and federal laws and regulations.

Continued...

SERVICE, PARTS, AND CLAIM INSTRUCTIONS:

Sufficient remedy parts supply is now available. The remedy parts must be ordered through PRIME. Please refer to 'Recalls & Campaigns/PRIME Max Quantities' on Subarunet for the orderable quantities.

RETAILER RESPONSIBILITY:

Please be advised that it is a violation of Federal law for a dealer to deliver a new motor vehicle covered by a recall under a sale or lease until the defect is remedied. Therefore, any Authorized Subaru Retailer failing to perform the applicable service procedures to correct all affected vehicles in their inventory prior to the vehicle being placed in service may be subject to civil penalties of up to \$21,000 per violation (i.e., for each vehicle), as provided in 49 CFR §578.6 and will also be in breach of the Subaru Dealer Agreement.

Any vehicles listed in any recall/campaign that are in retailer stock must be:

- Immediately identified
- Tagged or otherwise marked to prevent their delivery or use prior to repair
- Repaired in accordance with the repair procedures outlined in the Product Campaign Bulletin

Retailers are to promptly perform the applicable service procedures to correct all affected vehicles in their inventory (new, used, demo & SSLP).

In addition, whenever a vehicle subject to this recall is taken into retailer inventory necessary steps should be taken to ensure the recall correction has been made before selling or releasing the vehicle.

OWNER NOTIFICATION:

Subaru will notify affected vehicle owners by first class mail on June 4, 2020. A copy of the owner letter is shown at the end of this bulletin.

PARTS INFORMATION:

Now that sufficient quantities of the Fuel Pump Kits are available, repairs using complete Fuel Pump Assemblies must be discontinued.

Retailers with ongoing repairs using complete Fuel Pump Assemblies may complete them and submit for payment using the claim reimbursement information located on pg. 41 of this bulletin.

For the remaining vehicles included in this campaign, the parts required to perform these repairs have been assembled into Fuel Pump Kits, numbered for each model and labeled accordingly as shown below to help insure installation of the proper kit into the applicable model.

Description	Kit Part Number	Model Application
WRD-20 Fuel Pump Kit	X4202AL000	Legacy / Outback 2.5L
	X4202AL010	Legacy / Outback 3.6L
	X4202FL000	Impreza
	X4202XC000	Ascent

Continued...



The illustrations below list the component part content breakdowns for each of the four kits:

"IMPREZA" ONLY

X4202FL000/PUMP IMPREZA

Part Number	Part Name	Qty
42029FL020**	KIT FUEL PUMP: Contains fuel pump, filter sock, fuel pump o-rings, and c-clip.	1
42025FL01A	GASKET FUEL PUMP	1
42032FL01A	RING NUT	1
42056FL000	PLUG TEMPORARY	1

"ASCENT" ONLY

X4202XC000/PUMP ASCENT

Part Number	Part Name	Qty
42029XC000**	KIT FUEL PUMP: Contains fuel pump, filter sock, fuel pump o-rings, and c-clip.	1
42025FL000	GASKET FUEL PUMP	1
42032FL000	RING NUT	1
42057FL000	PLATE RING NUT	1
42056FL000	PLUG TEMPORARY	1

"LEG/OBK 2.5" ONLY

X4202AL000/PUMP LEGACY/OBK 2.5L

Part Number	Part Name	Qty
42029AL000**	KIT FUEL PUMP: Contains fuel pump, filter sock, fuel pump o-rings, c-clip, and fuel pump cushions (3).	1
42025AL040	GASKET FUEL PUMP	1
42056FL000	PLUG TEMPORARY	2

"LEG/OBK 3.6" ONLY

X4202AL010/PUMP LEGACY/OBK 3.6L

Part Number	Part Name	Qty
42029AL010**	KIT FUEL PUMP: Contains fuel pump, filter sock, fuel pump o-rings, c-clip, and fuel pump cushions (3).	1
42025AL030	GASKET FUEL PUMP	1
42056FL000	PLUG TEMPORARY	2

** NOTE: The "KIT FUEL PUMP" part numbers supplied are for reference only and cannot be ordered separately.

Continued...

ADDITIONAL REQUIRED MATERIALS / SPECIAL TOOLS:

- **42099FL030 Fuel Pipe Adapter:** Connects directly to the fuel pump outlet pipe at the fuel tank. Each retailer will be receiving two (2) of these automatically when they become available. Remove & discard the temporary plug before use.

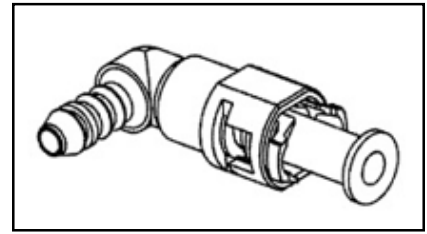

- **SOA635161 Hose Fuel:** This is a commonly available service part which can be used on all affected vehicles. This adapts the incoming fuel supply pipe and a section of bulk rubber fuel line. Each retailer will be receiving two (2) of these automatically when they become available. An additional fuel draining procedure will be added to this bulletin once these parts are available at retailers. See **APPENDIX A** on starting pg. 43 for more information.



- **42099CA010** (for Legacy and Outback) and **42099FL020** (for Ascent and Impreza) Fuel Tank Caps: To be put back into the fuel pump opening in the fuel tank after pump removal. These caps will help contain fuel odors and prevent contamination from entering the tank while the pump assembly is removed. Each retailer will be receiving two (2) of each part number automatically when they become available.

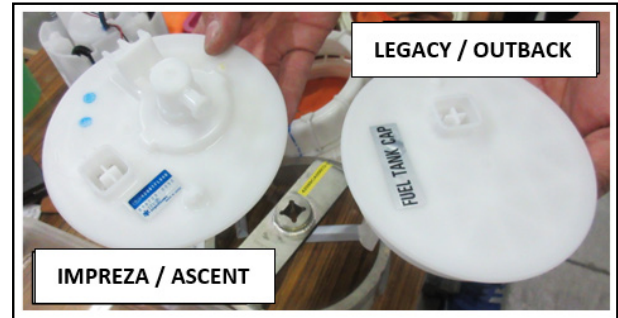

- **42099FL000 Ring Nut Wrench:** Used to remove and install the fuel pump assembly locking rings on Ascent and Impreza. This is already a required essential Subaru Special Service Tool.

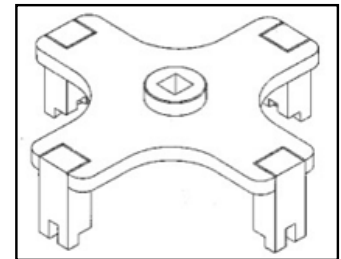

- **18471AA000 Fuel Pipe Adapter:** Used to drain fuel by connecting one end to the supply pipe connector at the fuel rail in the engine compartment and a length of bulk fuel hose going to a safety gasoline container on the other. This tool is already a required essential Subaru Special Service Tool and will be only be needed when performing repairs if fuel draining is required.

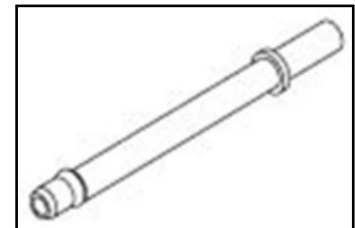

- **42099AE000 Release Tool:** Used to disengage the fuel pipe connector in the engine bay. This is already a required essential Subaru Special Service Tool.

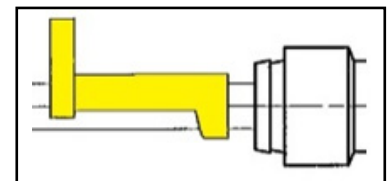

Continued...

NOTE: These adapters are only necessary when there is a need to lower the fuel level in the fuel tank:

- To drain fuel directly from the fuel pump outlet, use adapter **42099FL030**.
- To drain fuel from the fuel pipe hard line in the engine compartment, use adapter **SOA635161**. See **APPENDIX A** starting on pg. 43 for more information.
- To drain fuel from the fuel rail connection in the engine compartment, use adapter **18471AA000**.

In addition, some or all of the following 3) three items are needed to facilitate draining the fuel tank when required.:

- A readily available 5/16” barbed hose connecting nipple
- A 5-foot section of bulk 5/16” rubber fuel hose
- Two (2) small fuel line hose clamps.



IMPORTANT: A length of door edge guard, flexible tubing or heavy duty electrical tape to apply around the fuel pump access opening to avoid cuts / abrasions from sharp edges is required for all fuel pump replacement repairs.

SERVICE PROCEDURES / TABLE OF CONTENTS:

Carline	Begins on Page
Legacy / Outback	8
Impreza & Ascent TIPS	17
Impreza	20
Ascent	29

Service Procedure Information for ALL MODELS:

NOTES:

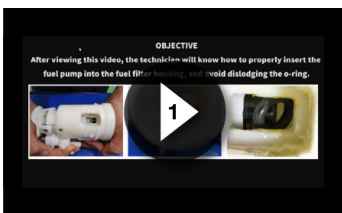

• The following information is intended to **SUPPLEMENT** the following and Service Manual procedures.

• Two new videos have been linked below to provide additional information regarding:

1) Installation of the new fuel pump component into the filter housing

2) Hints for getting the new retaining Ring Nut threads properly engaged onto the fuel tank threads.

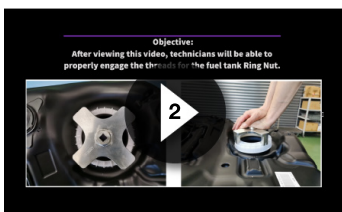

• These video links are included in **APPENDIX B** on pg. 48 and **APPENDIX C** on pg. 51 along with additional information.

VERY IMPORTANT: To avoid gasoline spillage, **THIS PROCEDURE MUST BE PERFORMED WHEN THE FUEL LEVEL IN THE TANK IS AT OR BELOW 2/3 FULL**. If over 2/3 full, the tank will need to be drained to 2/3 or less before attempting to remove the complete fuel pump assembly.

ALWAYS follow ALL the **CAUTIONS** and procedures for safely releasing fuel pressure and draining fuel from the fuel tank as supplied in the applicable Service Manual.

Continued...

ALWAYS remove the fuel filler cap to release any accumulated vapor pressure as a first step.

If draining fuel from the fuel tank is necessary, follow the applicable procedure this bulletin along with **“USING THE SELECT MONITOR”** procedure in the applicable Service Manual.

When removing the rear seat cushion (all models except Ascent), if the plastic retaining clips **(a)** (p.n. **64396KA010** for Legacy / Outback and **64333FJ000** for Impreza) in the floor come out, they become **one-time use** items and **MUST** be replaced during reassembly. When installing the seat cushion, always confirm the seat belt buckles are returned to the proper positions.

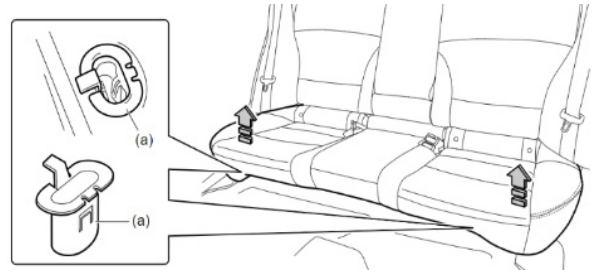

When removing the fuel pump access cover, there is a foam seal between the cover and the vehicle body. Use **CAUTION** when removing the cover to not damage the foam seal. If found to be or if it becomes damaged, the replacement seal part numbers are: **96077AJ00A** for Legacy / Outback and **96077FL00A** for Impreza and Ascent.

It cannot be stressed enough to have plenty of clean shop cloths and / or absorbent pads available to use when removing the fuel line(s) from the fuel pump. A small drip tray or pan is also recommended to use for catching any dripping fuel when removing the fuel pump assembly from the tank.



IMPORTANT: When performing these procedures, shop cloths contaminated with gasoline will be created. It is **CRITICAL** they be handled safely and following proper disposal guidelines. Always store contaminated shop cloths in an approved safety can as shown here.

After removing the rear seat cushion assembly and the (main) fuel pump access cover, use a length of small hose (sliced lengthwise), vinyl door edge guard as shown here or electrical tape to cover the edge of the access opening in the floor panel. This will protect any removed fuel line(s) and Technician hands from cuts or abrasions resulting from sharp edges. The photo here shows the power harness unplugged and shop cloths in place to absorb residual fuel that may remain in the lines after removal from the pump assembly. **CAREFULLY** release the retaining clip(s) with a small flat-blade screwdriver, put a cloth over the connection and remove the line(s). Immediately install the plug(s) provided in the replacement fuel pump kits into the removed line(s) to avoid any spillage. This will help reduce the chances of post-repair customer concerns of fuel odor inside the cabin.



On Legacy and Outback models, use a small container or magnetic dish to keep all the retaining ring nuts together while the pump assembly is removed.

Continued...

Have a small fuel-safe drain pan in place to catch any spilled fuel as the pump assembly is **CAREFULLY** lifted out of the fuel tank. If available, use a vacuum bleeder with a collection reservoir and hose to draw some of the stored fuel out of the fuel chamber surrounding the pump and filter to help avoid spillage. **NOTE:** On Ascent, there is a jet pump fuel tube attached to the lower portion of the fuel pump assembly as shown below, right which must also be removed before the pump assembly can be completely removed from the vehicle. Release the retaining clip with a small flat-blade screwdriver and remove the line but, secure the line with electrical tape or Mechanic's wire to keep it from falling into the tank once it is removed. If not secured, it will fall into the tank and have to be "fished" out prior to reinstalling the pump assembly.

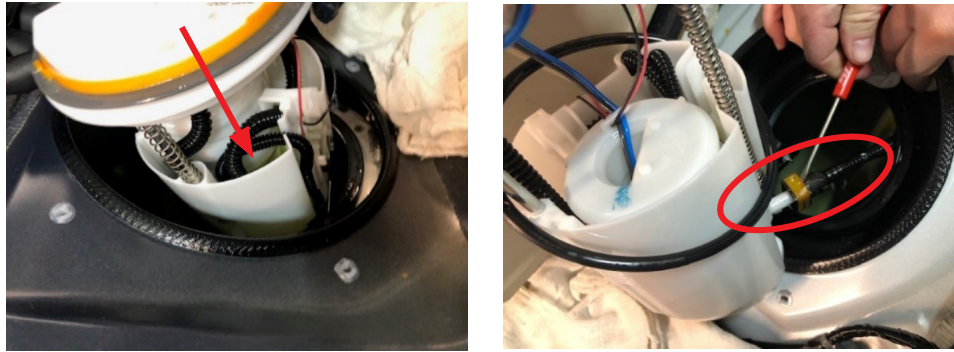

IMPORTANT: After the pump assembly is removed, **ALWAYS** install the applicable fuel tank cap (plug) as shown below or, cover the fuel tank opening with shop cloths or a fender cover (or an equivalent) to keep fuel odors from accumulating inside the cabin. These tools are not required when replacing the complete fuel pump assembly due to the very short time the tank will be open to complete the repair.



NOTE: When searching STIS for the applicable Service Manual procedures for reference, select **Fuel Filter REMOVAL** to get the detailed procedure for separating the pump / filter sock assembly from the complete fuel pump assembly. Fuel Filter removal is **NOT** required to complete this procedure. The replacement pumps come with a new filter sock already in place as shown here.



Continued...



For this recall, the 2-wire (Blue / Black) fuel pump wiring harness indicated as 1-time use in the Service Manual is reused but, should be inspected for damage or any evidence of overheating (discoloration of connectors, etc.). **IMPORTANT:** If any damage e.g. distorted or melting plastic connectors, overheated wiring or terminals is identified, the harness **MUST** be replaced. It easily unplugs from the fuel pump.

When reinstalling the thinner (Black / Red) fuel sender wires into the 2 retaining clips, they go into the clips first and are held in place by the thicker fuel pump harness wires.

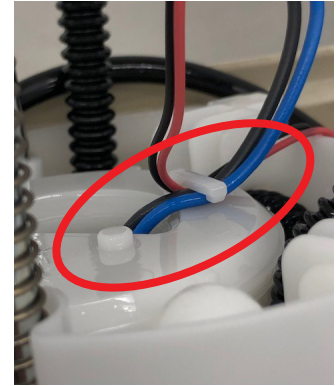

FUEL PUMP REPLACEMENT for 2019MY LEGACY and OUTBACK 2.5 and 3.6L Models:

IMPORTANT PRECAUTIONS:

- Place “NO OPEN FLAMES” signs near the working area.
- Be careful not to spill any fuel, especially when working inside the vehicle.
- Catch any leaking fuel from the removed fuel tube(s) using a small drain pan or cloths.
- If the fuel level in the tank is 2/3 full or more, drain the fuel to below 2/3 full before starting this procedure to avoid spilling any fuel.
- To prevent static electricity discharge / spark, always discharge any static electricity before starting this procedure using an anti-static cord and / or touching a grounded metal part of the vehicle body (e.g. door striker).
- Insure there is plenty of ventilation by opening windows of the vehicle and the service area.
- **ALWAYS** remove the fuel cap to release any accumulated evaporative / vapor pressure.

As mentioned earlier, select **Fuel Filter REMOVAL** in the applicable Service Manual to get the complete, detailed procedure for separating the fuel pump / filter sock from the complete fuel pump assembly. The following instructions will follow the Service Manual with additional photos to help clarify the step where applicable.

Continued...

FUEL PUMP ASSEMBLY COMPONENT BREAK-DOWN

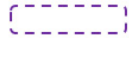
-  : Main component to be replaced
-  : * One-Time use parts included in kit

For this Campaign procedure, the connector cable (6) does not need to be replaced.

However, if either of the following conditions are found, replace it.

- Cracking of the harness insulation or
- Deformation / discoloration of any connector or terminal.

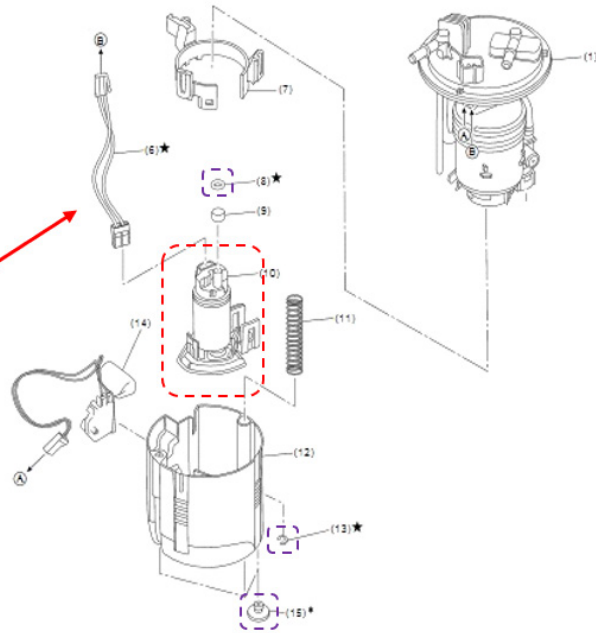

(1) Fuel filter ASSY	(6) Connector cable	(11) Spring
(2) O-ring	(7) Fuel pump holder	(12) Fuel chamber ASSY
(3) O-ring	(8) O-ring	(13) Clip
(4) Back-up ring	(9) Spacer	(14) Fuel level sensor
(5) Pressure regulator	(10) Fuel pump	(15) Cushion

*The 3 rubber cushions (15) on the bottom of the fuel chamber and included in the kit must be replaced as they are 1-time use.

1. Park the vehicle where the work will be performed. Release the fuel pressure:
 - Locate and remove the fuel pump fuse in the under-hood fuse box (M/B).
 - Start the engine and allow it to run until it stalls. **NOTE:** Even after the engine stalls, there will still be a small amount of residual pressure left in the fuel system. Crank the engine another 5 seconds with the starter.
2. Enter the driver seat and lower all windows. Using the fuel gauge in the Combination Meter, check the fuel level.
 - If the fuel gauge shows **two thirds (2/3) or more:** go to **STEP 3**
 - If the fuel gauge shows **less than two thirds:** go to **STEP 4.**
3. **(STEP 3A:)** If the fuel level is above 2/3, use the following procedure and fuel pipe adapter **18471AA000** (required tool) for connecting to the female fuel supply connection at the fuel rail. Connect the adapter and clamp a length of fuel hose to the other end. Empty the hose into a safety container as shown in the photo sequence below.

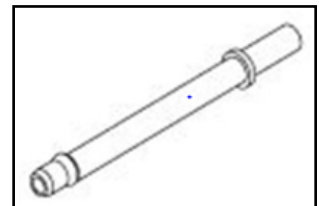

Continued...



Once the drain hose assembly is securely in place, connect the SSM4, turn the ignition ON and from the Active test item menu, select Fuel Pump Control to operate the fuel pump. Drain the fuel tank down until the fuel gauge reads at or below 2/3 full.

(STEP 3B:) Once available, the **PREFERRED** method for draining fuel will be to use the special adapter p.n. 42099FL030. **CAREFULLY** remove the rear seat cushion assembly and fuel pump access cover. Apply a length of door edge guard, flexible tubing or electrical tape around the pump access opening as protection from cuts / abrasions from any sharp edges. Release the quick disconnect fitting at the fuel pump outlet pipe. **While covering the fuel pipe with a clean shop cloth to catch any residual pressurized fuel**, slide the fuel delivery pipe off the fuel pump outlet. Insert the plastic temporary plug supplied in the kit into the removed fuel delivery pipe. The **one-time use** temporary plug is included in the replacement fuel pump parts kit.

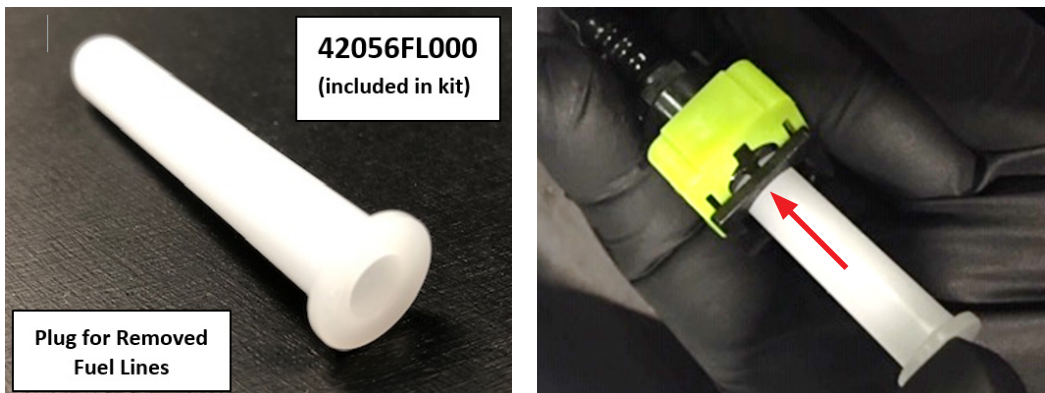

- Connect a sufficient length of 5/16" rubber fuel hose to the male hose barb portion of the adapter fitting. Always secure it with a small hose clamp to prevent leakage. Remove the plastic plug from the adapter and connect the adapter / hose assembly to the male fuel discharge tube of the fuel pump as shown below. Put the other end of the rubber fuel hose securely into a safety container to collect the drained fuel. Once the drain hose assembly is securely in place, connect the SSM4, turn the ignition ON and from the Active test item menu, select Fuel Pump Control to operate the fuel pump. Drain the fuel tank down until the fuel gauge reads at or below 2/3 full.

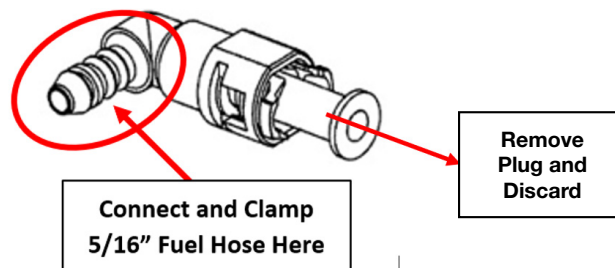

Continued...

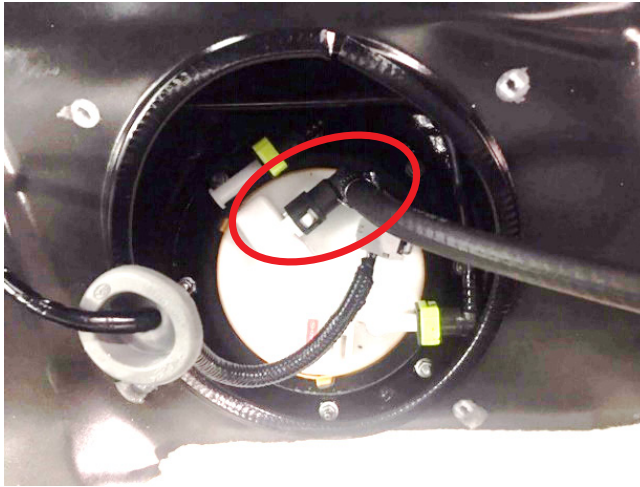

4. While holding the battery sensor firmly with one hand to avoid damage, loosen and disconnect the ground terminal.
5. If not already done in **STEP 3**, **CAREFULLY** remove the rear seat cushion assembly, set it aside in a clean, safe place and remove the fuel pump access cover. Take care to not damage the foam seal.

REMINDER: ALWAYS remove the fuel tank filler cap to release any remaining vapor pressure.

6. Fuel Pump Assembly Removal:

- **CAREFULLY** using **HAND TOOLS ONLY**, remove the fuel pump access cover while paying close attention to avoid damaging the foam seal between the cover and vehicle body. Replace the seal if damaged with p.n. **96077AJ00A** (rare case). **NEVER** use air or electric tools when performing this step
 - Apply a length of door edge guard, flexible tubing or electrical tape around the pump access opening as protection from cuts / abrasions from any sharp edges.
 - Release the quick disconnect fitting at the fuel pump outlet pipe, and **while covering the pipe and connector with a clean shop cloth to catch any residual pressurized fuel**, slide the fuel delivery pipe off the fuel pump outlet tube. Insert the plastic temporary plug into the fuel delivery pipe connector. The **one-time use** temporary plug is included in the replacement fuel pump parts kit.
 - **CAREFULLY** using **HAND TOOLS ONLY**, remove the nuts securing the fuel pump top plate to the fuel tank. **CAUTION:** If the nuts are hard to loosen, use a lubricant on them and take care not to break the fuel tank studs. **NEVER** use air or electric tools when performing this step
 - **CAREFULLY** remove the fuel pump assembly from the fuel tank. Use a vacuum tool with a reservoir, squeeze bottle or an equivalent tool to remove residual fuel from the fuel chamber of the pump assembly along with a small catch pan to prevent spilling fuel as the pump assembly is removed. **IMPORTANT:** Do not let the fuel level sensor arm or float contact the tank opening during removal.
7. Once the fuel pump assembly has been removed, install the applicable plastic plug tool into the fuel tank opening to prevent contamination from entering the tank and fuel vapors from accumulating in the vehicle interior. If the plug is not available, cover the opening with a clean shop cloth.

Continued...

8. After disconnecting the pump and sending unit harness connectors from the underside of the top flange, **CAREFULLY** remove the fuel sending unit from the pump chamber.
IMPORTANT: If any damage e.g. distorted or melting plastic connectors, overheated wiring or terminals is identified, the harness **MUST** be replaced. Release the retaining clip (a plastic trim tool is being used here) and slide the sending unit upward. **NEVER** touch the contact surface of the sending unit and use care to avoid bending or otherwise damaging the float arm and contact point.



- **CAREFULLY** disconnect both the fuel pump and fuel sending unit harness connectors and remove the wiring from the retaining clips. Note the wire routing prior to disassembly for reference during reassembly.
- Compress the spring (fuel filter assembly) and remove / discard the (one-time use) c-clip (ring clip).
- **IMPORTANT:** When releasing the retaining claws as described in the following steps, move them **only as far as needed** to disengage them. If any break, the affected component must be replaced.
- Release the retaining claw for the tube at the bottom of the fuel chamber.
- **CAREFULLY** release the 3 claws for the pump holder from the fuel chamber then raise the pump / filter assembly upward.

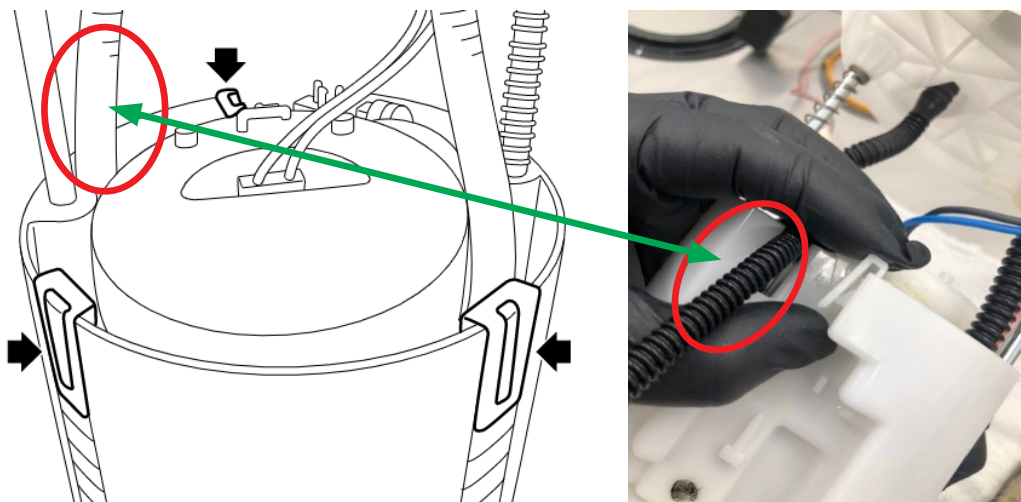

Continued...

- **CAREFULLY** remove the fuel tube assembly from the fuel chamber using a small flat-blade screwdriver wrapped with protective tape as shown.

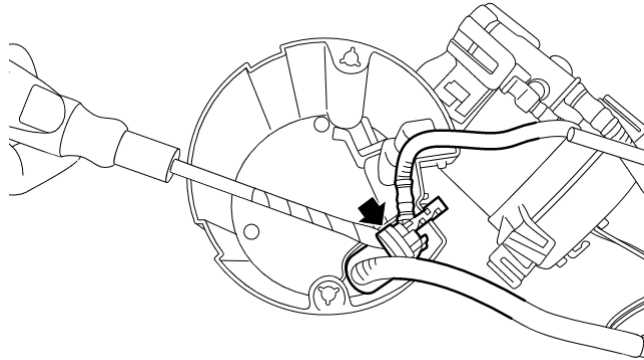

- Using 2 small flat-blade screwdrivers, **CAREFULLY** release the 2 claws securing the fuel pump to the regulator.

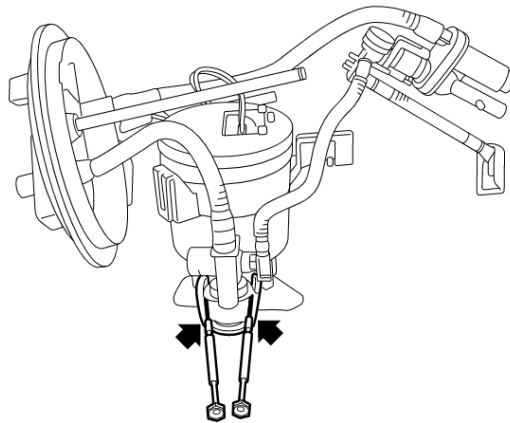

- Release the 3 remaining claws at the bottom of the fuel pump then **CAREFULLY** press down on the top of the pump to push it out the bottom of the fuel filter assembly.

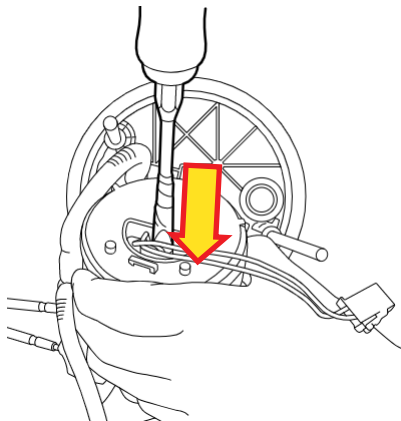
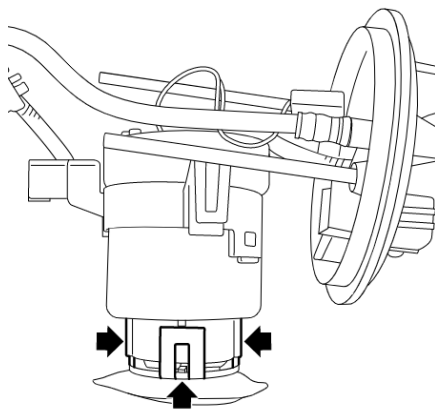

STOP HERE DO NOT remove the pressure regulator or otherwise go any further with disassembly of the fuel pump assembly.

IMPORTANT: Remove the o-ring and spacer from the original fuel pump. The spacer is reused. Put the removed pump in a vise and crush it as shown above to eliminate any chance of it being reused.

Continued...

9. Install the New Fuel Pump Assembly:

- Transfer the white plastic spacer (B) to the new pump and install the new o-ring (A) from the kit to hold the spacer in place. **It is CRITICAL for the bushing and NEW o-ring to be installed on the new pump in the proper order.** Always lubricate the new o-rings with gasoline. **IMPORTANT:** Always confirm the original o-ring came out of the filter assembly during disassembly. If not, use a rubber-tipped or plastic (non-marring) pick tool to **CAREFULLY** remove it without scratching the filter assembly bore.

Plastic
Non-Marring
Pick Tool

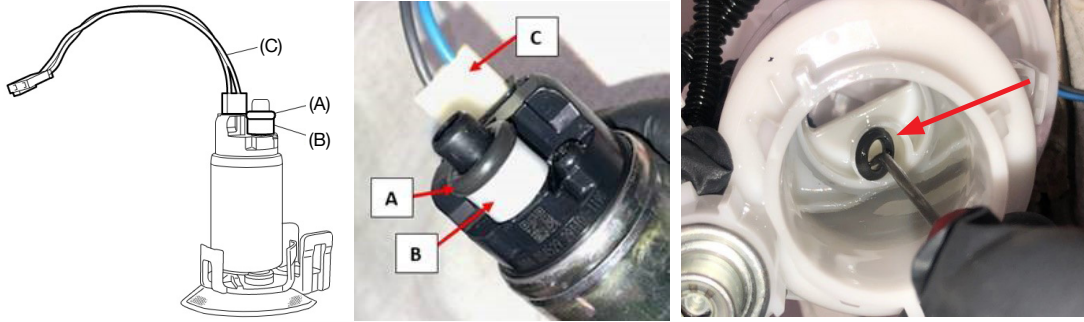

- Install the new fuel pump into the fuel filter assembly. Using the image below as a guide, lay the partially reassembled pump assembly on the bench horizontally and insert the new pump into the fuel filter assembly. Using both hands, **CAREFULLY** press the new pump and filter assemblies together until a “click” is heard from ALL of the new fuel pump’s retaining claws. If the new pump does not fully seat and lock into position, make sure the old o-ring (A) is not still in the bore as shown above. **See Appendix B starting on pg. 48 for more information and a video on this CRITICAL step.**

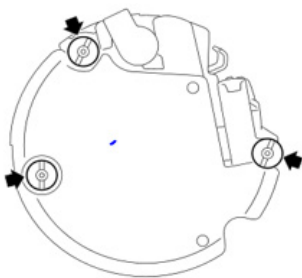
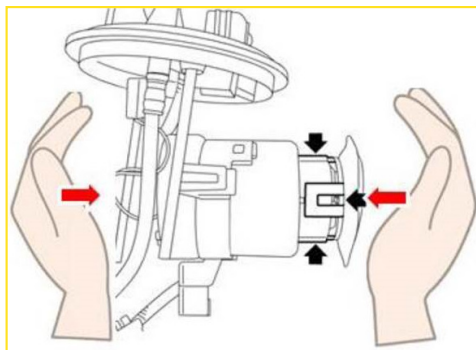

- Replace all 3 rubber cushions (feet) on the bottom of the fuel chamber, replacements are included in the kit. Failure to replace these may result in a later noise complaint.
- CAREFULLY** refit the tube assembly back into the fuel chamber until it clicks into position.
- Refit the tube back on to the bottom side of the fuel chamber.

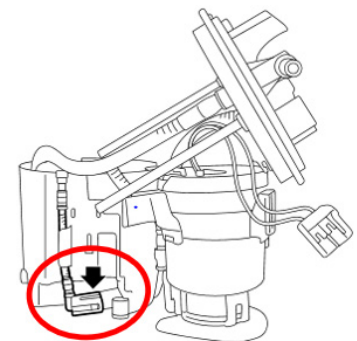

Continued...

- Refit the spring **(B)** to the rod with the snap ring groove then re-install the pump / filter assembly into the fuel chamber. **IMPORTANT:** Confirm tube **(A)** is routed UNDER the retaining claw then lock all 3 claws in place.

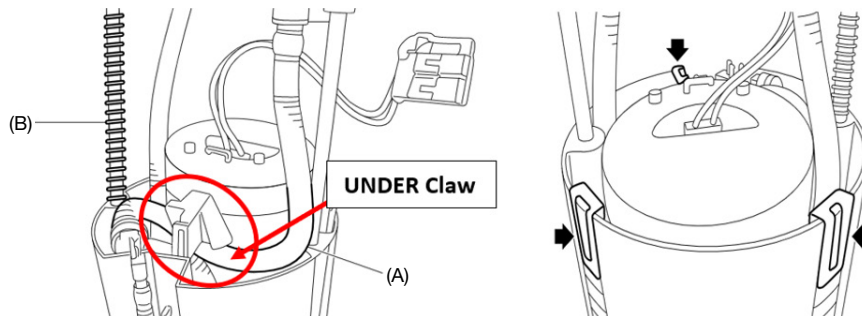

- Press the top of the pump assembly downward and install the new c-clip (ring clip) included in the kit.
- Re-connect the fuel pump harness. **CAREFULLY** refit the fuel level sensor assembly to the fuel chamber. Put the (thinner) fuel level sensor wires into the 2 retaining clips first followed by the fuel pump wires **IN THAT ORDER**.

10. IMPORTANT: Make sure all the sealing surfaces are free from fuel or foreign matter before reinstalling the fuel pump assembly.

- CAREFULLY** reinstall the fuel pump assembly into the tank in the proper position / orientation. **ALWAYS** use the new gasket included in the kit.
- IMPORTANT:** Use CAUTION to keep the fuel level sensor arm from contacting the fuel tank opening. If the arm were to become bent, the fuel gauge may not read properly.
- Using the illustrations below for reference, align the recess of the fuel pump upper plate cushion to the protrusion **(A)** of the fuel pump assembly.
- While keeping cutout **(B)** of the fuel pump upper plate toward the rear of the vehicle, align protrusion **(C)** of the fuel pump upper plate cushion with the cutout.
- CRITICAL:** Lightly hand tighten all nuts in the sequence shown below. Complete tightening of the 8 retaining nuts to the specified torque: **4.4 Nm, (3.2 ft. lbs. or 38 inch-pounds)** following the sequence shown below. **NEVER** use air or electric powered tools to tighten these nuts as the studs may be damaged.

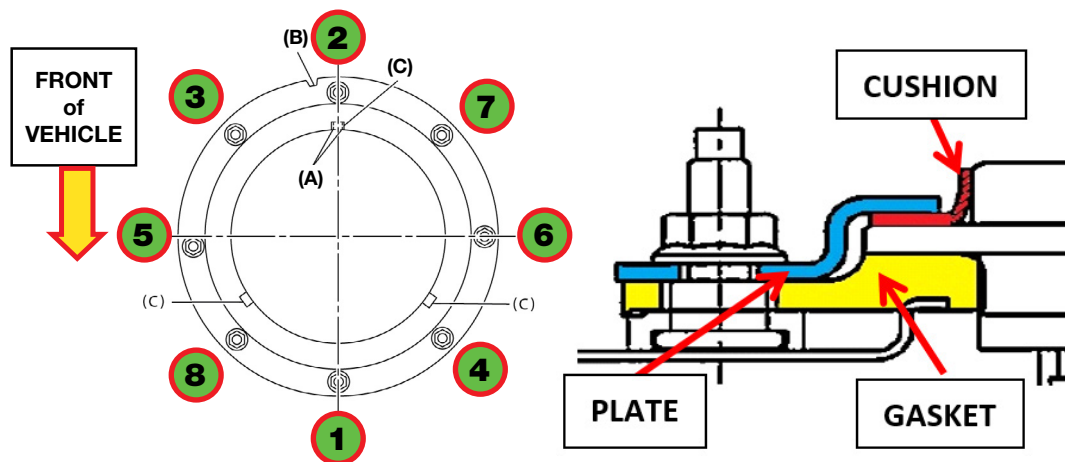

Continued...

- Remove and discard the plastic temporary plug from the fuel delivery pipe and re-connect the pipe to the fuel pump outlet tube. Make sure the connector is all the way onto the outlet tube then lock the slider. Tug on the delivery pipe to be sure it is fully locked in place.

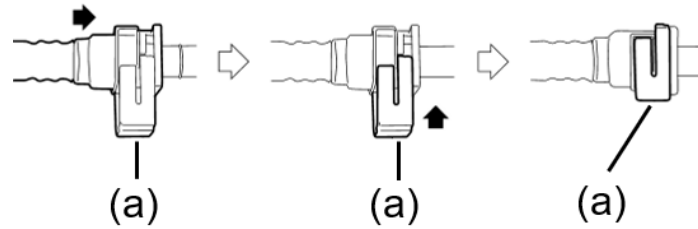

IMPORTANT REMINDERS: Discard the plastic fuel line plug as it is a one-time use item. Reusing the plug may damage the connector's internal o-ring and cause a fuel leak.

- Ensure both the pipe and tube are clean and dry
- If the slider does not move easily, confirm the pipe is engaged on the tube
- ALWAYS confirm the pipe is fully engaged after connecting and check for any leaks

11. Reconnect the harness connector to the fuel pump.
12. Reconnect the ground cable to the battery sensor. Torque to 7.5 Nm (5.5 ft. lbs.) while supporting the sensor with the other hand.
13. Turn on the ignition switch to run the fuel pump. The engine does not need to be started. Check closely for any leaks around ALL fuel delivery tube connections removed as part of this repair (including those under the hood if fuel was drained) and around the top plate
14. Reinstall the inspection cover.
15. Reinstall the seat cushion assembly while making sure the seat belt buckles are properly positioned. **IMPORTANT NOTE:** If any of the plastic clips securing the seat cushion to the body were displaced when removing the seat cushion, they MUST be replaced.
16. Return any removed fuel back to the vehicle.
17. Deodorize the vehicle interior as necessary.

END OF LEGACY / OUTBACK SERVICE PROCEDURES

Continued...

Helpful TIPS for 2019MY IMPREZA and ASCENT Models:

The procedure for replacing the fuel pump on Impreza and Ascent is very similar to the Legacy and Outback. The major differences are described here:

- Both fuel pump assemblies are retained into the fuel tank by a threaded locking ring (ring nut) instead of a top plate secured by studs and nuts. There are separate procedures for tightening these ring nuts. A special tool (**42099FL000**) is used for both models. A 1/2-inch drive breaker bar and Torque wrench (for Impreza) are also required. New ring nuts and the required sealing rings are included in the replacement fuel pump part kits.
- **IMPORTANT:** Always press down vertically on the center of the tool with one hand and pull squarely on the bar or wrench with the other to keep it from slipping off the ring nut.
- **CRITICAL:** There are 2 procedures for tightening the ring nuts:
 - The Impreza ring nut is simply tightened to **130 Nm (96 ft. lbs.)**, followed by a **CRITICAL** height measurement check in 3 places to confirm there is no cross-threading. The black arrow indicates the thread starting point of the ring nut threads..
 - The Ascent ring nut uses a starting point identified by aligning hash marks molded into the top of the fuel tank with another set on the ring nut. Another set of hash marks molded into the tank and 90 degrees to the right (90 degrees clockwise from the first set) identify the tightening finish point “Range Marks”. The Ascent procedure also includes a height measurement check in 3 places to confirm there is no ring nut cross-threading.

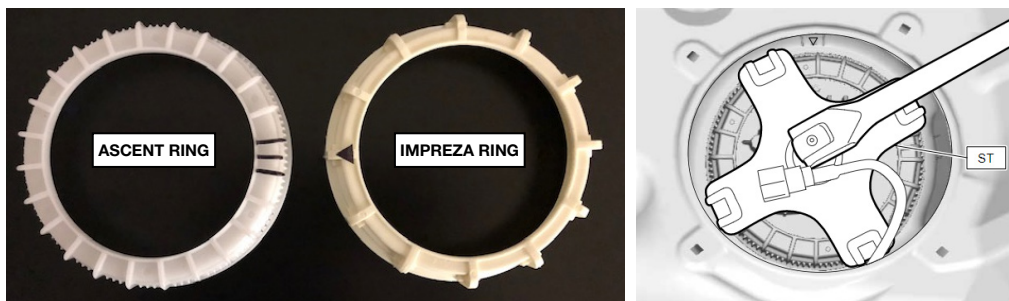

Ascent Ring Nut Markings:

- Inspect the new ring nut and identify the set of 3 “teeth” close together as shown above. **NOTE:** The center or middle line (GREEN tooth) must be aligned with the triangle Δ mark in the middle of the thread starting point hash marks as shown below. Also, there is another Δ mark on the top of the fuel pump (Indexing Arrow) to be used as a reference for making sure the pump is properly indexed inside the tank. **See Appendix C starting on pg. 51 for more information and a video on this CRITICAL step.**

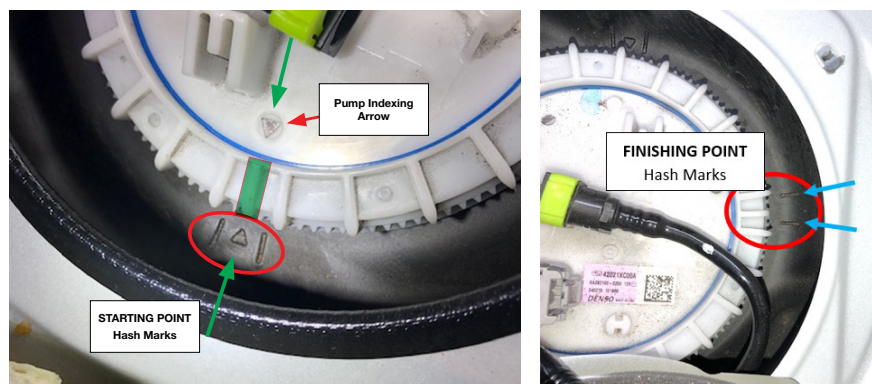

Continued...

- Once the initial alignment is done, start tightening the ring nut with the special tool. As it tightens, the up and down movement of the fuel pump assembly will be reduced. Once this up and down movement can no longer be felt (one full turn), it is **VERY IMPORTANT** to make sure the indexing arrow of the fuel pump assembly stays aligned with the arrow in the center of the starting point hash marks. At this point, the ring nut should only need final tightening to get the middle line into the range of (between) the Finishing Point Range hash marks. **REMINDER:** As the final tightening is completed, make sure the indexing arrow is still aligned with the arrow in the center of the starting point hash marks. If not, loosen the ring nut reposition the pump properly and re-tighten.
- **TIP:** To help stop the pump from turning while tightening the ring nut, make sure the new gaskets and all the surfaces they contact (top of fuel tank, top and bottom of the fuel pump flange and both sides of the top seal plate) are thoroughly cleaned of any residual gasoline or other contamination and completely dry. Areas to focus on are shown in red below.



- On Impreza, start the ring nut with the indexing arrow centered between the hash marks. Tighten the ring to 96 ft. lbs. **IMPORTANT:** As the specified torque approaches, confirm the indexing arrow on the fuel pump stays between the hash marks. When successful alignment and torque are achieved, perform the height adjustment check procedure below.

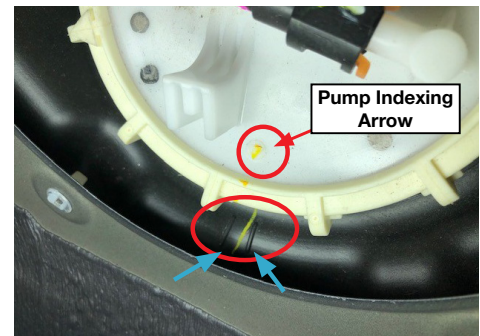

Height Adjustment Checks:

- **CRITICAL:** These height measurement checks **MUST** be made as a final check to confirm the ring nut is not cross-threaded.
- **Ascent:** 23.8 +/- 2.5 mm (.937 +/- .098 in.) measured in 3 positions around the ring nut. The best tool for doing this measurement is a digital caliper as shown below. Measure from the top edge of the ring nut “teeth” to the top surface of the tank.
- **Impreza:** After the specified torque is reached, measure the height using a digital caliper as shown below between the flats adjacent to the ring nut “teeth” to the top surface of the tank in 3 places. All 3 measurements must be between 1.5 mm of each other.

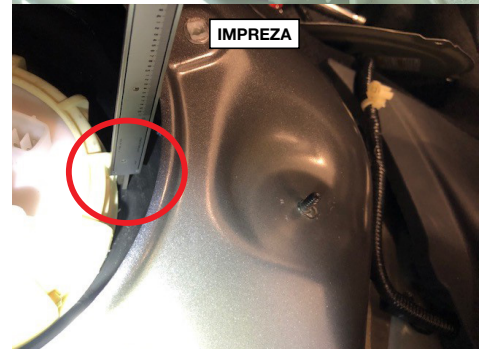
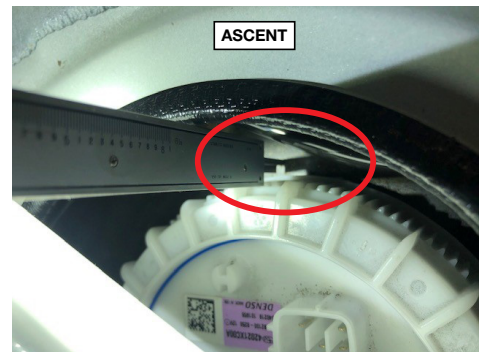

Continued...

NOTE: In cases where the ring nut does not thread properly onto the fuel tank, it will be necessary to “jump” one thread to avoid cross-threading of the ring nut and tank. To do this, begin threading the ring nut onto the tank at a minimal angle until slight turning resistance is felt. The ring nut thread starting points are identified by the triangle arrow Δ on the Impreza ring and the set of 3 lines close together on the Ascent ring nut (Green arrows in photo below and highlighted with black marker on the parts). Once the resistance is felt, apply a quick, downward, non-percussive force to the side of the ring opposite from where the threads were started. A slight “pop” sound should be heard. Once the pop has been heard and while keeping downward pressure on the ring nut, continue threading the ring nut onto the tank until it can no longer be turned by hand. Proceed with the remainder of the tightening and height adjustment procedures as described above. **See Appendix C starting on pg. 51 for more information and a video on this CRITICAL step.**

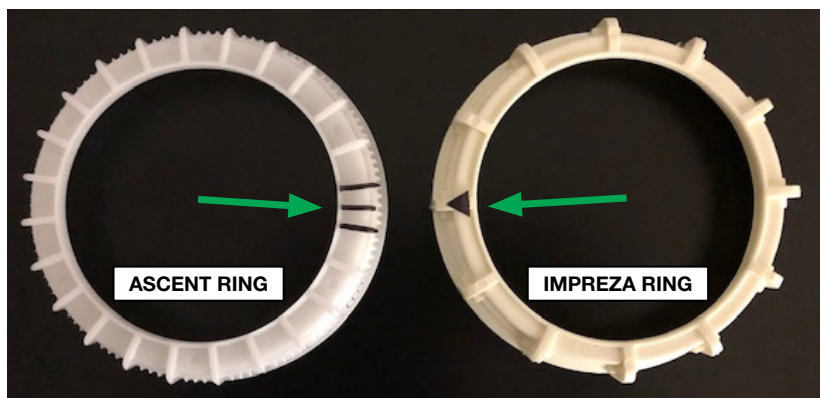
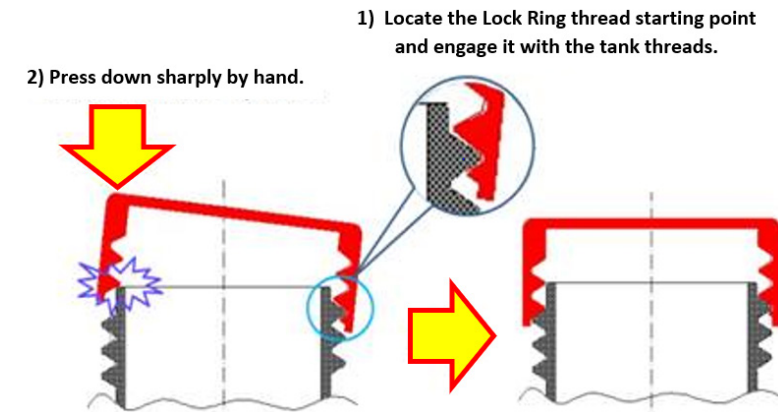

Other differences (between the Legacy / Outback procedure) to be aware of:

1. The fuel pump is secured to the filter assembly with 3 retaining claws instead of 5.
2. Instead of having 2 fuel line connections on the pump assembly, Impreza and Ascent only use 1.
3. Impreza does not utilize a “saddle” type fuel tank therefore, there is also no jet pump.

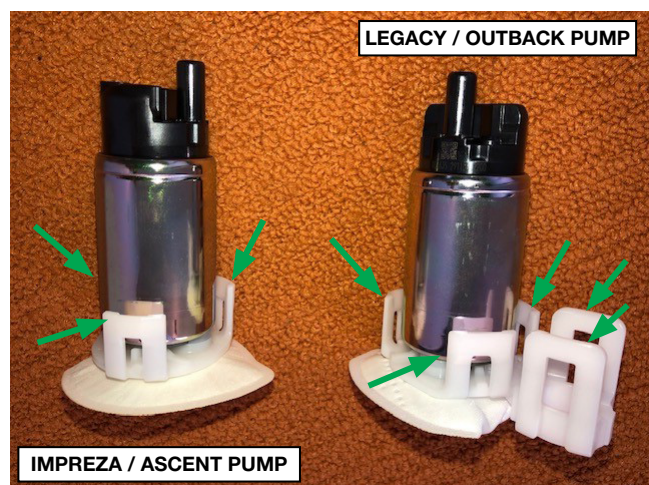

Continued...

4. Both models utilize a large o-ring seal between the fuel pump assembly and the tank instead of a rubber gasket. Ascent uses an additional blue plastic sealing washer between the lock ring and top of the fuel pump assembly.
5. Ascent has a jet pump fuel line connection to the fuel chamber inside the tank. When removing this line, if desired, it can be secured either with tape or a piece of Mechanic's wire under the connector slider to keep it from dropping inside the fuel tank.

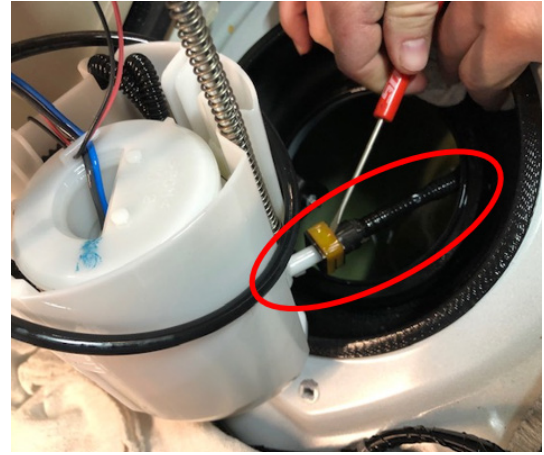

END OF IMPREZA & ASCENT TIPS

FUEL PUMP REPLACEMENT for 2019MY IMPREZA Models:

IMPORTANT PRECAUTIONS:

- Place “NO OPEN FLAMES” signs near the working area.
- Be careful not to spill any fuel, especially when working inside the vehicle.
- Catch any leaking fuel from the removed fuel tube(s) using a small drain pan or cloths.
- If the fuel level in the tank is 2/3 full or more, drain the fuel to below 2/3 full before starting this procedure to avoid spilling any fuel.
- To prevent static electricity discharge / spark, always discharge any static electricity before starting this procedure using an anti-static cord and / or touching a grounded metal part of the vehicle body (e.g. door striker).
- Insure there is plenty of ventilation by opening windows of the vehicle and the service area.
- ALWAYS remove the fuel cap to release any accumulated evaporative / vapor pressure.

As mentioned earlier, select **Fuel Filter REMOVAL** in the applicable Service Manual to get the complete, detailed procedure for separating the fuel pump / filter sock from the complete fuel pump assembly. The following instructions will follow the Service Manual with additional photos to help clarify the step where applicable.

Continued...

FUEL PUMP ASSEMBLY COMPONENT BREAKDOWN

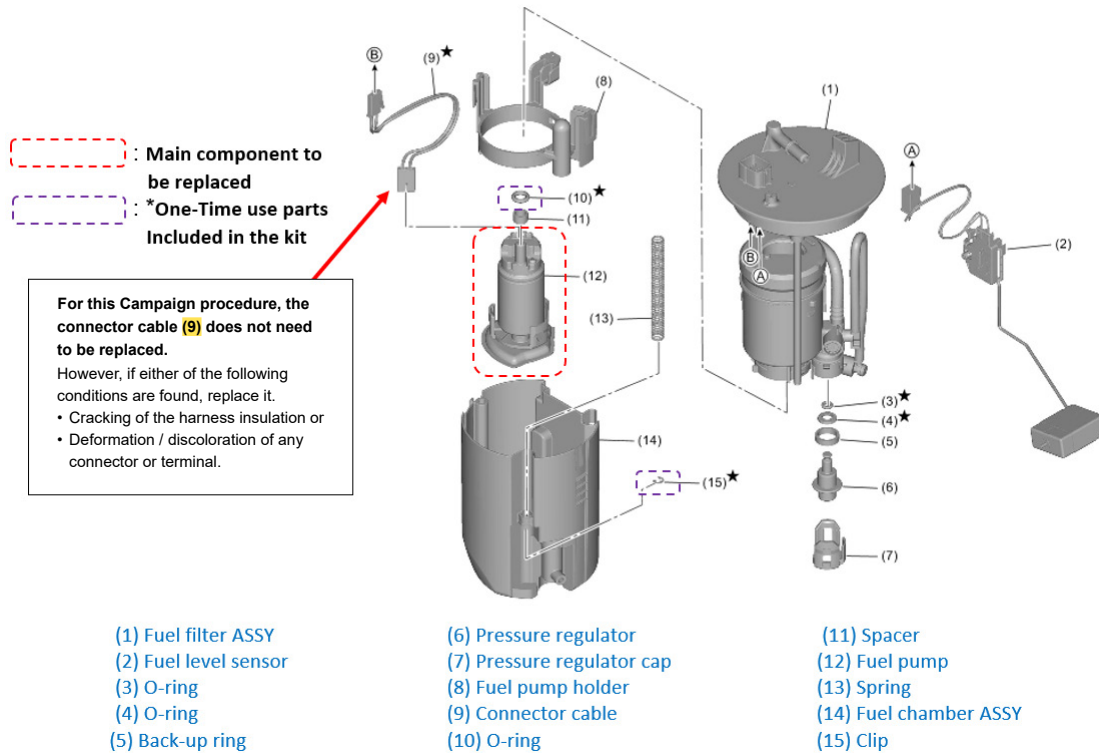

1. Park the vehicle where the work will be performed. Release the fuel pressure:
 - Locate and remove the fuel pump fuse in the under-hood fuse box (M/B).
 - Start the engine and allow it to run until it stalls. **NOTE:** Even after the engine stalls, there will still be a small amount of residual pressure left in the fuel system. Crank the engine another 5 seconds with the starter.
2. Enter the driver seat and lower all windows. Using the fuel gauge in the Combination Meter, check the fuel level.
 - If the fuel gauge shows **two thirds (2/3) or more:** go to **STEP 3**
 - If the fuel gauge shows **less than two thirds:** go to **STEP 4.**
3. **(STEP 3A:)** If the fuel level is above 2/3, use the following procedure and fuel pipe adapter **18471AA000** (required tool) for connecting to the female fuel supply connection at the fuel rail. On Impreza, removing the intake air duct makes the connection point easier to access. Connect the adapter and clamp a length of fuel hose to the other end. Empty the hose into a safety container as shown in the photo sequence below.

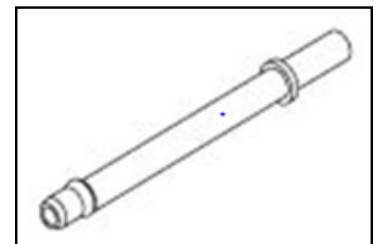

Continued...



Once the drain hose assembly is securely in place, connect the SSM4, turn the ignition ON and from the Active test item menu, select Fuel Pump Control to operate the fuel pump. Drain the fuel tank down until the fuel gauge reads at or below 2/3 full.

(STEP 3B:) Once available, the **PREFERRED** method for draining fuel will be to use the **special adapter p.n. 42099FL030**. **CAREFULLY** remove the rear seat cushion assembly and fuel pump access cover. Apply a length of door edge guard, flexible tubing or electrical tape around the pump access opening as protection from cuts / abrasions from any sharp edges. Release the quick disconnect fitting at the fuel pump outlet pipe. **While covering the fuel pipe with a clean shop cloth to catch any residual pressurized fuel**, slide the fuel delivery pipe off the fuel pump outlet. Insert the plastic temporary plug supplied in the kit into the removed fuel delivery pipe. The **one-time use** temporary plug is included in the replacement fuel pump parts kit. This plug is not required if the fuel pump assembly is being replaced due to the very short disconnection time.

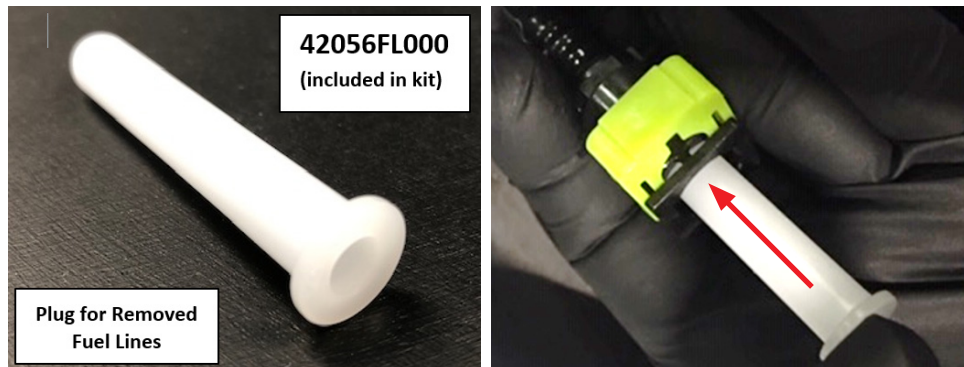

- Connect a sufficient length of 5/16" rubber fuel hose to the male hose barb portion of the adapter fitting. Always secure it with a small hose clamp to prevent leakage. Remove the plastic plug from the adapter and connect the adapter / hose assembly to the male fuel discharge tube of the fuel pump as shown below. Put the other end of the rubber fuel hose securely into a safety container to collect the drained fuel. Once the drain hose assembly is securely in place, connect the SSM4, turn the ignition ON and from the Active test item menu, select Fuel Pump Control to operate the fuel pump. Drain the fuel tank down until the fuel gauge reads at or below 2/3 full.

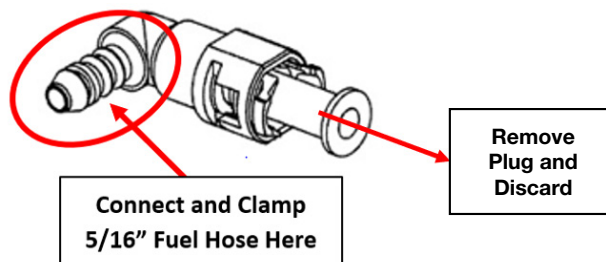

Continued...

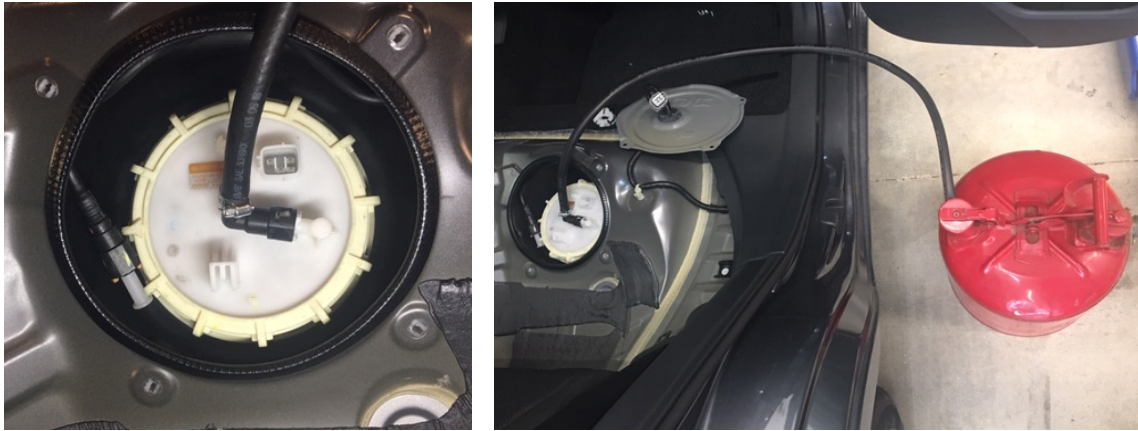

4. Disconnect the ground terminal from battery and wait 60 seconds before proceeding.

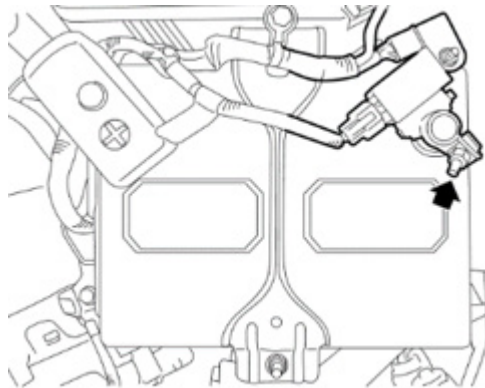

5. If not already done in **STEP 3**, **CAREFULLY** remove the rear seat cushion assembly, set it aside in a clean, safe place. While pushing the corners of the rear seat cushion from above, pull the knobs of the retaining hooks forward. Lift up on the front of the cushion assembly to disengage the rear hooks and remove it.

REMINDER: ALWAYS remove the fuel tank filler cap to release any remaining vapor pressure.

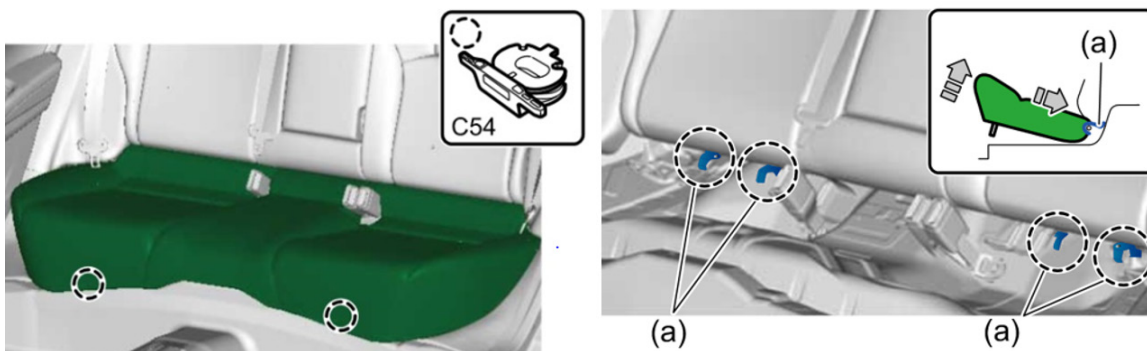

CAUTION:

- The Airbag system satellite safing sensor is located under the front center of the rear seat cushion. Be careful not to apply any strong impacts to the sensor when working with the rear seat cushion removed.

Continued...

6. Fuel Pump Assembly Removal:

- **CAREFULLY** remove the fuel pump access cover while paying close attention to avoid damaging the foam seal between the cover and vehicle body. Replace the seal if damaged with p.n. **96077FL00A** (rare case).
- Apply a length of door edge guard, flexible tubing or electrical tape around the pump access opening as protection from cuts / abrasions from any sharp edges.
- Release the quick disconnect fitting at the fuel pump outlet pipe, **and while covering the pipe and connector with a clean shop cloth to catch any residual pressurized fuel**, slide the fuel delivery pipe off the fuel pump outlet tube. Insert the plastic temporary plug into the fuel delivery pipe connector. The **one-time use** temporary plug is included in the replacement fuel pump parts kit.
- Disconnect the harness connector from the pump.
- **CAREFULLY** using **HAND TOOLS ONLY** and the Ring Nut Wrench tool shown here, remove the plastic retaining ring securing the fuel pump assembly in the fuel tank.
NOTE: Make sure the removed fuel delivery pipe is **ON TOP** of the tool as shown and not pinched under it.
- **CAREFULLY** remove the fuel pump assembly from the fuel tank. Use a vacuum tool with a reservoir, squeeze bottle or an equivalent tool to remove residual fuel from the fuel chamber of the pump assembly along with a small catch pan to prevent spilling fuel as the pump assembly is removed. **IMPORTANT:** Do not let the fuel level sensor arm or float contact the tank opening during removal.
- Once the fuel pump assembly has been removed, install the applicable plastic plug tool into the fuel tank opening to prevent contamination from entering the tank and fuel vapors from accumulating in the vehicle interior. If the plug is not available, cover the opening with a clean shop cloth. The plug is not required when replacing the complete fuel pump assembly due to the very short time the tank will be open for that repair.

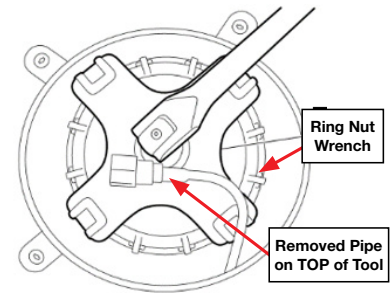

7. After disconnecting the pump and sending unit harness connectors from the underside of the top flange, **CAREFULLY** remove the fuel sending unit from the pump chamber.
IMPORTANT: If any damage e.g. distorted or melting plastic connectors, overheated wiring or terminals is identified, the harness **MUST** be replaced. Release the retaining clip (a plastic trim tool is being used here) and slide the sending unit upward. **NEVER** touch the contact surface of the sending unit and use care to avoid bending or otherwise damaging the float arm and contact point.



Continued...

8. **CAREFULLY** disconnect both the fuel pump and fuel sending unit harness connectors and remove the wiring from the retaining clips. Note the wire routing prior to disassembly for reference during reassembly.

- Compress the spring (fuel filter assembly) and remove / discard the (one-time use) c-clip.
- **IMPORTANT:** When releasing the retaining claws as described in the following steps, move them only **as far as needed** to disengage them. If any break, the affected component must be replaced.
- Using a flat-blade screwdriver wrapped with protective tape (or equivalent), release the connector for the fuel tube at the bottom of the fuel chamber. Remove the fuel tube from the side of the fuel chamber as shown.
- **CAREFULLY** disengage three claws of the fuel pump holder from the fuel chamber assembly. Remove the fuel pump and filter assembly from the chamber.

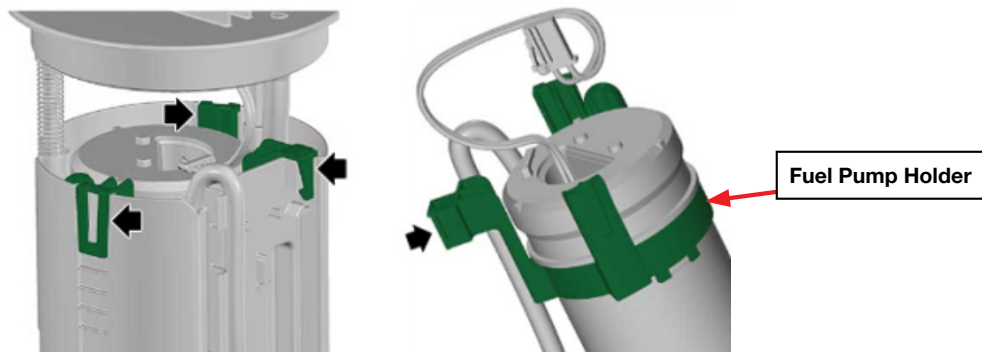
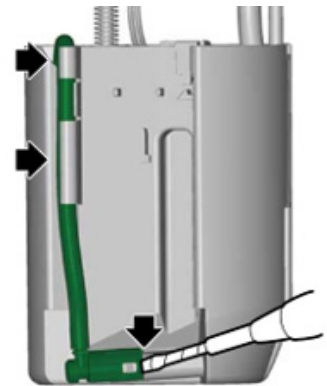

- **CAREFULLY** remove the fuel pump holder from the fuel filter assembly.
- Disengage the 3 claws at the bottom of the fuel pump.
- Using the flat tip screwdriver or similar tool wrapped with a protective tape, press on the fuel pump and remove the fuel pump from the fuel filter assembly.

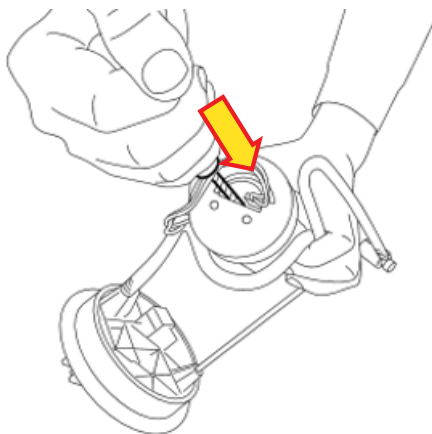
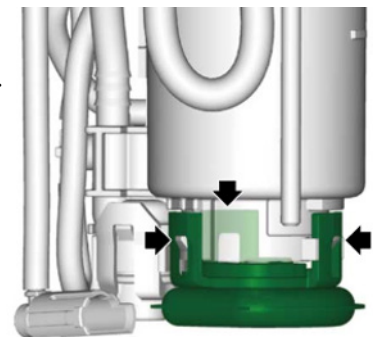

IMPORTANT: Remove the o-ring and spacer from the original fuel pump. The spacer is reused. Put the removed pump in a vise and crush it as shown here to eliminate any chance of it being reused.

Continued...

- Transfer the white plastic spacer **(B)** to the new pump and install the **new o-ring (A)** from the kit to hold the spacer in place. Lubricate the new o-ring with gasoline.
- **IMPORTANT:** Always confirm the original o-ring came out of the filter assembly during disassembly. If not, use a rubber-tipped or plastic (non-marring) pick tool to **CAREFULLY** remove it without scratching the filter assembly bore. Transfer the white plastic spacer **(B)** to the new pump and install the **new o-ring (A)** from the kit to hold the spacer in place. **It is CRITICAL for the bushing and NEW o-ring to be installed on the new pump in the proper order.** Always lubricate the new o-rings with gasoline.

Plastic
Non-Marring
Pick Tool

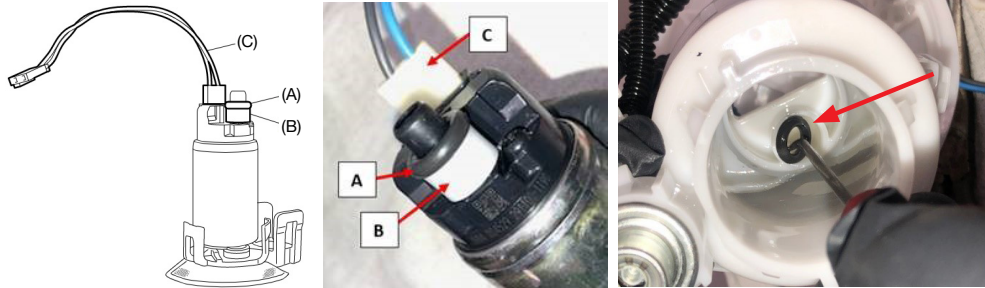

9. Install the new fuel pump into the fuel filter assembly. Using the image here as a guide, lay the partially reassembled pump assembly on the bench horizontally and insert the new pump into the fuel filter assembly. Using both hands, **CAREFULLY** press the new pump and filter assemblies together until a “click” is heard from **ALL** of the new fuel pump’s retaining claws. If the new pump does not fully seat and lock into position, make sure the old o-ring (A) is not still in the bore as shown above.

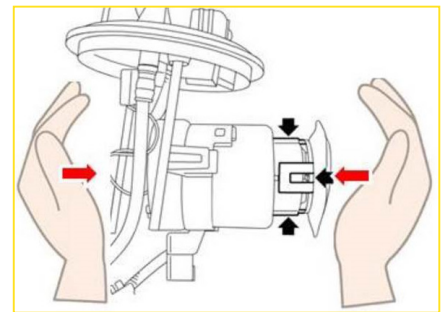

See **Appendix B** starting on pg. 48 for more information and a video on this **CRITICAL** step.

- Refit the fuel pump holder to the fuel filter assembly.
- Reinstall the fuel filter assembly into the fuel chamber. Make sure the fuel tube and the spring are properly positioned as shown in the photo and illustration below.

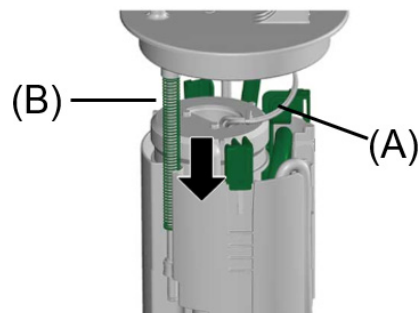
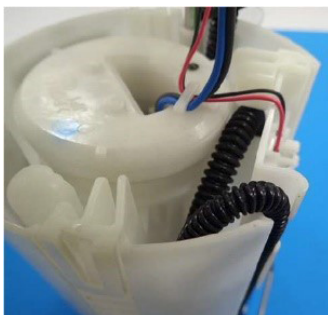

- Confirm the 3 claws securing the fuel filter assembly into the fuel chamber are fully engaged.
- Secure the fuel tube to the outside of the fuel chamber and reconnect it at the bottom.
- Push the fuel filter assembly in the direction of the arrow to compress, and install the new clip supplied in the kit.

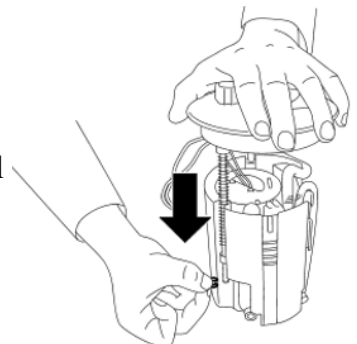

Continued...

10. **CAREFULLY** refit the fuel level sensor assembly to the fuel chamber. Put the (thinner) fuel lever sensor wires into the 2 retaining clips first followed by the fuel pump wires **IN THAT ORDER**.

- **CRITICAL:** ALL surfaces of the new pump assembly o-ring, top gasket, underside of the ring nut along with the surfaces described and shown below: fuel tank neck rim (A) pump flange top and bottom faces (B) and (C) must be thoroughly wiped clean and completely dried **BEFORE** re-installation. This will help prevent the pump from turning with the ring nut during final tightening.



(A) Fuel Tank Rim



(B) Pump Flange Top Face

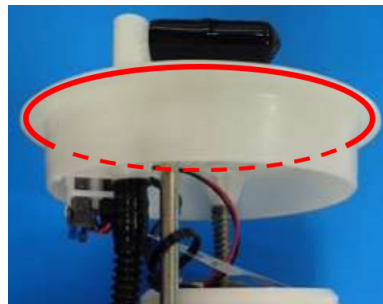

(C) Underside of Pump Flange

- Use **CAUTION** to keep the fuel level sensor arm from contacting the fuel tank opening. If the arm were to become bent, the fuel gauge may not read properly.

11. **CAREFULLY** reinstall the fuel pump assembly into the tank in the proper position / orientation as shown below. **ALWAYS** use the new gasket included in the kit. Position the indexing arrow Δ between the molded-in hash marks (blue arrows) on the fuel tank.

- Install the new ring nut included in the kit. The new ring nut has a triangle index mark Δ (shown in black here for illustration purposes) similar to the fuel pump to indicate the ring nut thread starting point (if needed).

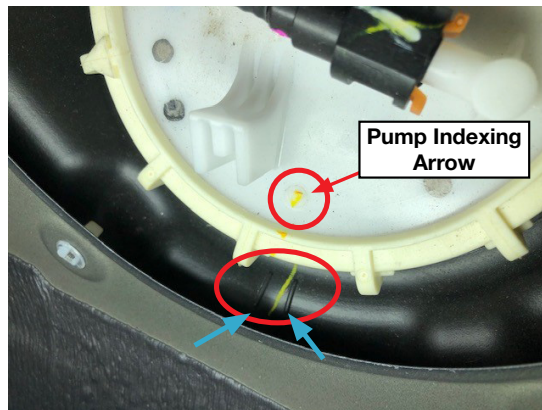

- **NOTE:** In a case where there is difficulty getting the ring nut threads started onto the fuel tank threads, align the starting points, install the ring nut wrench then press down firmly by hand on the ring nut wrench to “jump” the ring nut thread past the interference point. A “pop” sound will occur, the ring nut should now be parallel to the top of the fuel tank and able to be tightened by hand. See Appendix C starting on pg. 51 for more information and a video on this **CRITICAL** step.

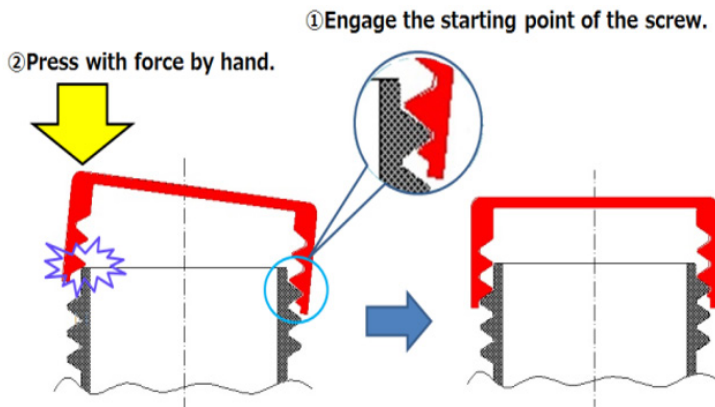

Continued...

12. **CAUTION:** SLOWLY tighten the new ring nut to 130 Nm (96 ft. lbs.) while paying close attention to make sure the fuel pump does not rotate along with the ring nut. If the pump were to turn more than 45 degrees, the fuel level sensor will likely be damaged. When properly tightened, the index mark on the ring nut Δ should align with the fuel pump indexing arrow Δ (Center Line (A)).

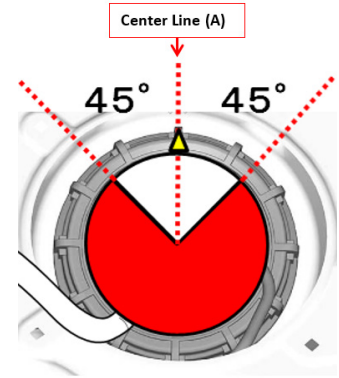

13. **CRITICAL:** Using a caliper with depth gauge, measure the dimension in 3 positions between the top of the ring nut and the top of fuel tank as shown in the illustration and photo (inset) below. The difference between the three measurements cannot exceed $\pm 1.5\text{mm}$ or $.060$ inch.

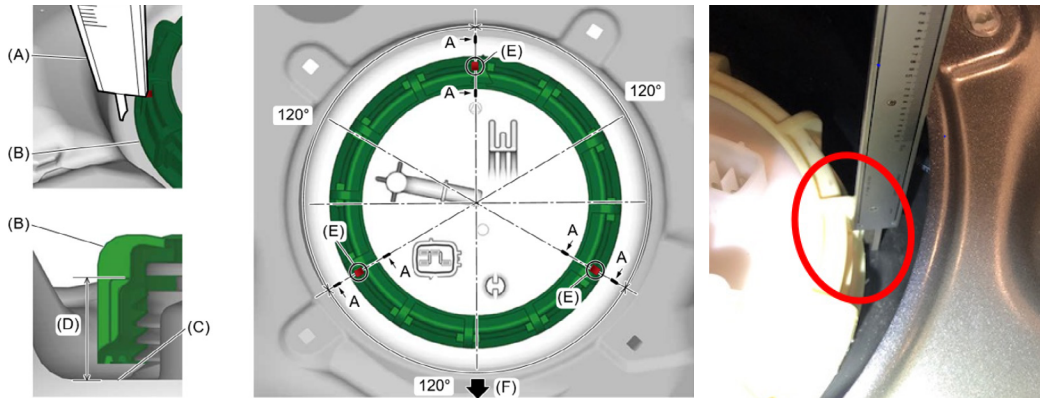

CAUTION:

- If the difference between any of the three measurements exceeds $\pm 1.5\text{mm}$ or $.060$ inch, loosen and re-tighten the ring nut to correct any cross-threading.
- If the ring nut or fuel pump gasket are deformed, cracked or damaged, they **MUST** be replaced.

14. Remove and discard the plastic temporary plug from the fuel delivery pipe and re-connect the pipe to the fuel pump outlet tube. Make sure the connector is all the way onto the outlet tube then lock the slider. Tug on the fuel delivery pipe to be sure it is fully locked in place.

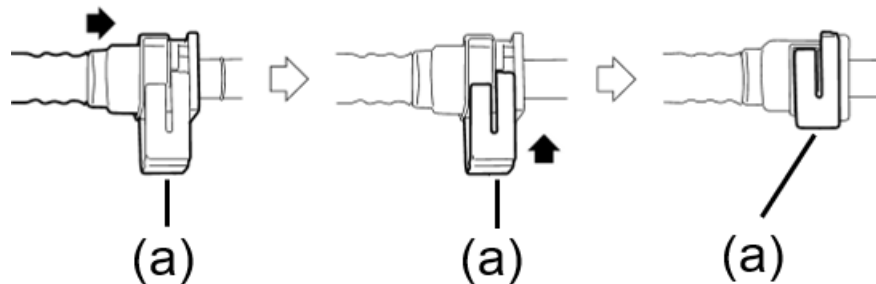

IMPORTANT REMINDERS: Discard the plastic fuel line plug as it is a one-time use item. Reusing the plug may damage the connector's internal o-ring and cause a fuel leak.

- Ensure both the pipe and tube are clean and dry
- If the slider does not move easily, confirm the pipe is engaged on the tube
- ALWAYS confirm the pipe is fully engaged after connecting and check for any leaks

Continued...

15. **REMINDER:** Discard the removed temporary plug as it is a one-time use item. Reusing the plug may damage the connector's internal o-ring and cause a fuel leak.
16. Reconnect the harness connector to the fuel pump.
17. Reconnect the ground cable to the battery. Torque to 7.5 Nm (5.5 ft. lbs.).
18. Turn on the ignition switch to run the fuel pump. The engine does not need to be started. Check closely for any leaks around ALL fuel delivery tube connections removed as part of this repair (including those under the hood if fuel was drained) and around the ring nut.
19. Reinstall the inspection cover.
20. Reinstall the seat cushion assembly while making sure the seat belt buckles are properly positioned. **IMPORTANT NOTE:** If any of the plastic clips securing the seat cushion to the body were displaced when removing the seat cushion, they **MUST** be replaced.
21. Return any removed fuel back to the vehicle.
22. Deodorize the vehicle interior as necessary.

END OF IMPREZA SERVICE PROCEDURE

FUEL PUMP REPLACEMENT for 2019MY ASCENT Models:

IMPORTANT PRECAUTIONS:

- Place “NO OPEN FLAMES” signs near the working area.
- Be careful not to spill any fuel, especially when working inside the vehicle.
- Catch any leaking fuel from the removed fuel tube(s) using a small drain pan or cloths.
- If the fuel level in the tank is 2/3 full or more, drain the fuel to below 2/3 full before starting this procedure to avoid spilling any fuel.
- To prevent static electricity discharge / spark, always discharge any static electricity before starting this procedure using an anti-static cord and / or touching a grounded metal part of the vehicle body (e.g. door striker).
- Insure there is plenty of ventilation by opening windows of the vehicle and the service area.
- **ALWAYS** remove the fuel cap to release any accumulated evaporative / vapor pressure.

As mentioned earlier, select **Fuel Filter REMOVAL** in the applicable Service Manual to get the complete, detailed procedure for separating the fuel pump / filter sock from the complete fuel pump assembly. The following instructions will follow the Service Manual with additional photos to help clarify the step where applicable.

Continued...

FUEL PUMP ASSEMBLY COMPONENT BREAKDOWN

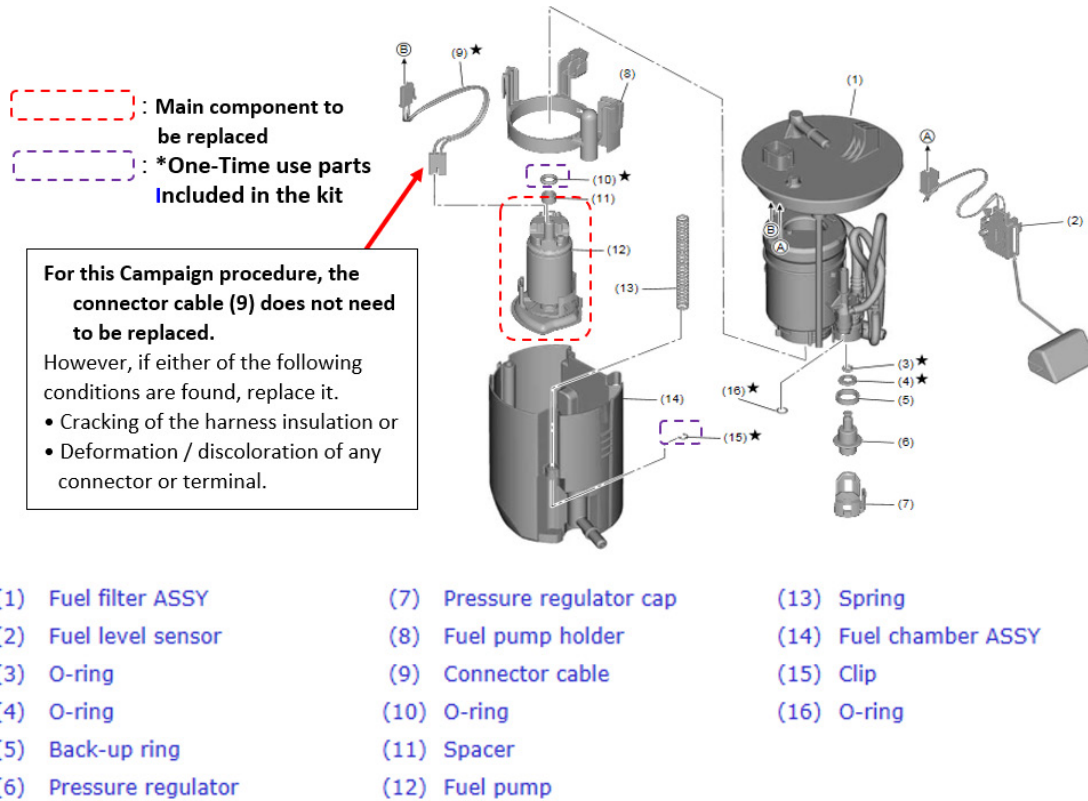

1. Park the vehicle where the work will be performed. Release the fuel pressure:
 - Locate and remove the fuel pump fuse in the under-hood fuse box (M/B).
 - Start the engine and allow it to run until it stalls. **NOTE:** Even after the engine stalls, there will still be a small amount of residual pressure left in the fuel system. Crank the engine another 5 seconds with the starter.
2. Enter the driver seat and lower all windows. Using the fuel gauge in the Combination Meter, check the fuel level.
 - If the fuel gauge shows **two thirds (2/3) or more:** go to **STEP 3**
 - If the fuel gauge shows **less than two thirds:** go to **STEP 4.**
3. **(STEP 3A:) Use this procedure only when the tools in Step 3B below are unavailable.** If the fuel level is above 2/3, use the following procedure and fuel pipe adapter **18471AA000** (required tool) for connecting to the female fuel supply connection at the fuel rail. On Ascent, removing the intercooler is required to access the connection point. Connect the adapter and clamp a length of fuel hose to the other end. Empty the hose into a safety container as shown in the photo sequence below.

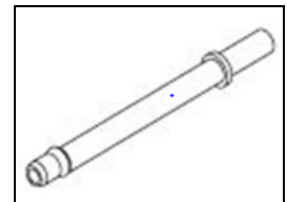

Continued...

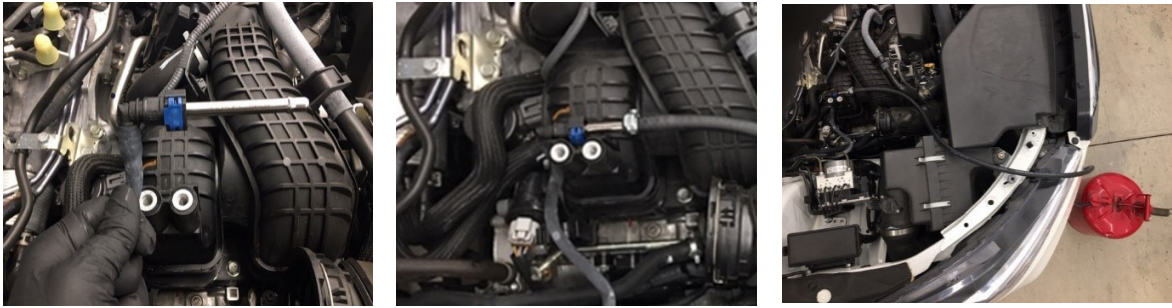

IMPORTANT: When removing the intercooler, the intake duct gaskets p.n. **14497AA080** and p.n. **21896AA130** are both 1-time use and **MUST** be replaced. Remove the Intercooler and duct as an assembly. Do not separate them.

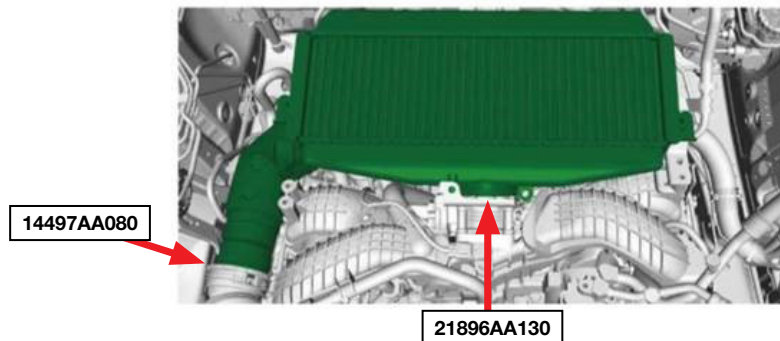

Once the drain hose assembly is securely in place, connect the SSM4, turn the ignition ON and from the Active test item menu menu, select Fuel Pump Control to operate the fuel pump. Drain the fuel tank down until the fuel gauge reads at or below 2/3 full.

(STEP 3B:) Once available, the **PREFERRED** method for draining fuel will be to use the special adapter p.n. **42099FL030**. After **CAREFULLY** removing the retaining bolt trim covers, **CAREFULLY** remove the right rear seat assembly following the procedure in the applicable Service Manual and set it aside in a safe place. **REMINDER:** Always protect the surrounding trim and painted surfaces when removing and reinstalling the seat assembly. Using a helper for this step is also **STRONGLY** recommended. Remove the section of floor mat covering the fuel pump access cover. With the access cover removed, apply a length of door edge guard, flexible tubing or electrical tape around the pump access opening as protection from cuts / abrasions from any sharp edges. Release the quick disconnect fitting at the fuel pump outlet pipe. **While covering the fuel pipe with a clean shop cloth to catch any residual pressurized fuel**, slide the fuel delivery pipe off the fuel pump outlet. Insert the plastic temporary plug supplied in the kit into the removed fuel delivery pipe. The **one-time use** temporary plug is included in the replacement fuel pump parts kit. This plug is not required if the fuel pump assembly is being replaced due to the very short disconnection time.

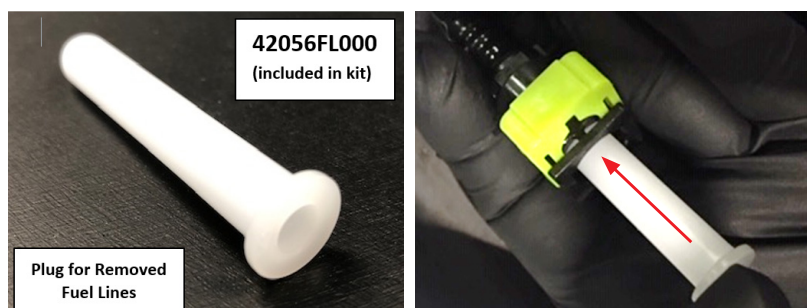

Continued...

- Connect a sufficient length of 5/16" rubber fuel hose to the male hose barb portion of the adapter fitting. Always secure it with a small hose clamp to prevent leakage. Remove the plastic plug from the adapter and connect the adapter / hose assembly to the discharge tube of the fuel pump as shown below. Put the other end of the rubber fuel hose securely into a safety container to collect the drained fuel. Once the drain hose assembly is securely in place, connect the SSM4, turn the ignition ON and from the Active test item menu, select Fuel Pump Control to operate the fuel pump. Drain the fuel tank down until the fuel gauge reads at or below 2/3 full.

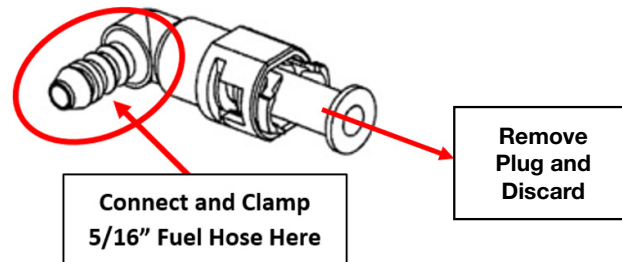

4. While holding the battery sensor firmly with one hand to avoid damage, loosen and disconnect the ground terminal and harness connector.

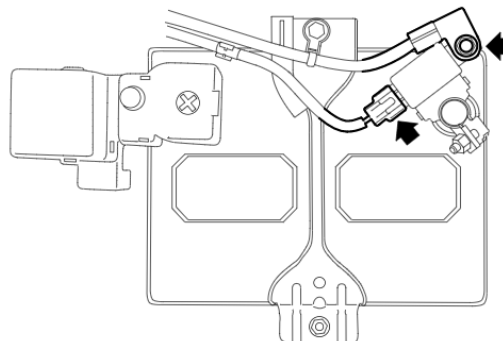

REMINDER: ALWAYS remove the fuel tank filler cap to release any remaining vapor pressure.

5. If not already done in **STEP 3**, **CAREFULLY** remove the retaining bolt trim covers and **CAREFULLY** remove the right rear second row seat assembly following the procedure in the applicable Service Manual. **ALWAYS** disconnect the seat heater connection (if equipped) before lifting the seat. **IMPORTANT NOTE:** the side impact sensor is under the carpeting of the center seating area. Avoid hard impacts to this area during seat removal and installation. **REMINDER:** Always protect the surrounding trim and painted surfaces when removing and reinstalling the seat assembly. Using a helper for this step is also **STRONGLY** recommended. Set seat aside in a clean, safe place.

Continued...

- Remove the section of floor mat covering the fuel pump access cover. **CAREFULLY** remove the fuel pump access cover while paying close attention to avoid damaging the foam seal between the cover and vehicle body. Replace the seal if damaged with p.n. **96077FL00A** (rare case). With the access cover removed, release the quick disconnect fitting at the fuel pump outlet pipe. **While covering the fuel pipe with a clean shop cloth to catch any residual pressurized fuel**, slide the fuel delivery pipe off the fuel pump outlet. Insert the **one-time use** plastic temporary plug into the removed fuel delivery pipe. The plug is included in the replacement fuel pump parts kit.

6. Fuel Pump Assembly Removal:

- Disconnect the harness connector from the pump.
- CAREFULLY** using **HAND TOOLS ONLY** and the Ring Nut Wrench tool shown here, remove the plastic retaining ring nut securing the fuel pump assembly into the fuel tank. **NOTE:** Make sure the removed fuel delivery pipe is **ON TOP** of the tool as shown and not pinched under it.

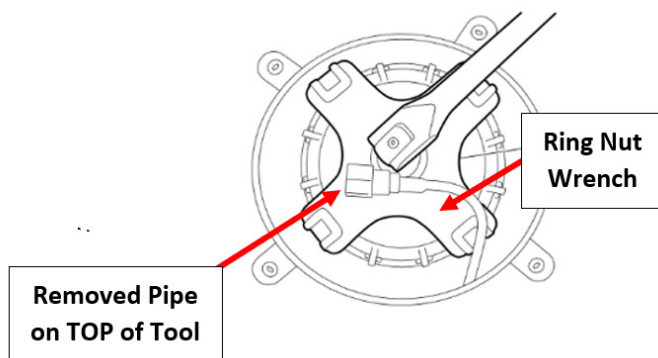

- CAREFULLY** remove the fuel pump assembly from the fuel tank. Use a vacuum tool with a reservoir, squeeze bottle or an equivalent tool to remove residual fuel from the fuel chamber of the pump assembly along with a small catch pan to prevent spilling fuel as the pump assembly is removed. **IMPORTANT:** Do not let the fuel level sensor arm or float contact the tank opening during removal.
- IMPORTANT NOTE:** Ascent has a jet pump fuel tube connection to the fuel chamber inside the fuel tank. When removing this line, if desired, it can be secured either with tape or a piece of Mechanic's wire under the connector slider to keep it from dropping inside the fuel tank.
- Once the fuel pump assembly has been removed, install the applicable plastic plug tool into the fuel tank opening to prevent contamination from entering the tank and fuel vapors from accumulating in the vehicle interior. If the plug is not available, cover the opening with a clean shop cloth. The plug is not required when replacing the complete fuel pump assembly due to the very short time the tank will be open for that repair.

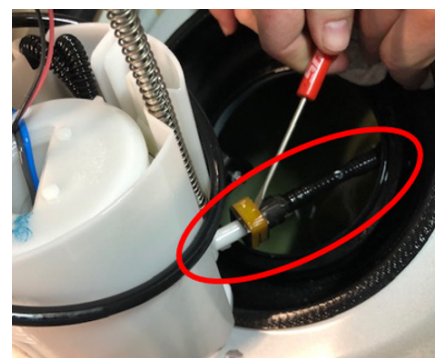

Continued...

7. After disconnecting the pump and sending unit harness connectors from the underside of the top flange, **CAREFULLY** remove the fuel sending unit from the pump chamber.
IMPORTANT: If any damage e.g. distorted or melting plastic connectors, overheated wiring or terminals is identified, the harness **MUST** be replaced. Release the retaining clip (a plastic trim tool is being used here) and slide the sending unit upward. **NEVER** touch the contact surface of the sending unit and use care to avoid bending or otherwise damaging the float arm and contact point.



- **CAREFULLY** disconnect both the fuel pump and fuel sending unit harness connectors and remove the wiring from the retaining clips. Note the wire routing prior to disassembly for reference during reassembly.
- Compress the spring (fuel filter assembly) and remove / discard the (one-time use) c-clip.
- **IMPORTANT:** When releasing the retaining claws as described in the following steps, move them **only as far as needed** to disengage them. If any break, the affected component must be replaced.
- Using a screwdriver wrapped with protective tape (or equivalent), release the retaining claw for the tube at the bottom of the fuel chamber then disengage the fuel tube from the outside of the outside of the chamber.
- **CAREFULLY** disengage three claws of the fuel pump holder from the fuel chamber assembly. Remove the fuel pump and filter assembly from the chamber.
- Using a screwdriver wrapped with protective tape (or equivalent), remove the tube assembly from the fuel chamber assembly, and separate the fuel filter assembly and fuel chamber assembly as shown below.

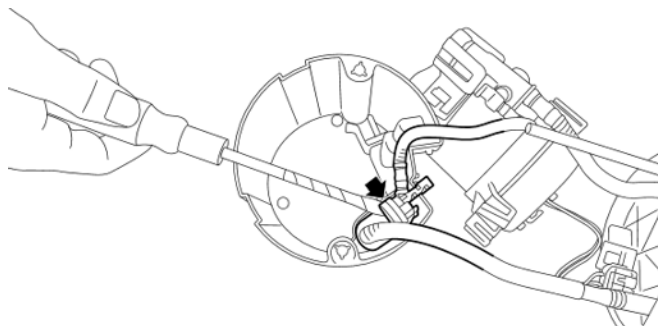
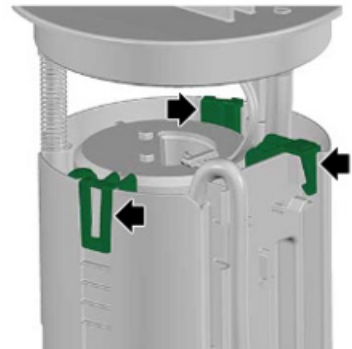

Continued...

- After separating the fuel filter from the fuel chamber assembly, inspect the fuel chamber to confirm the o-ring is not still in the bore as shown here. If the o-ring remains, use a rubber -tipped or plastic (non-marring) pick tool to **CAREFULLY** remove it without scratching the fuel chamber bore.

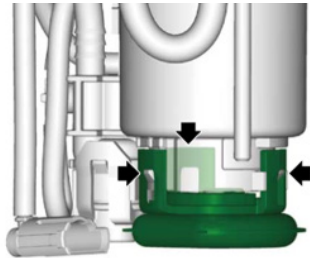
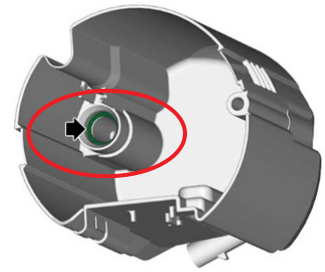

- Remove the fuel pump holder then disengage the 3 claws securing the fuel pump to the filter assembly.

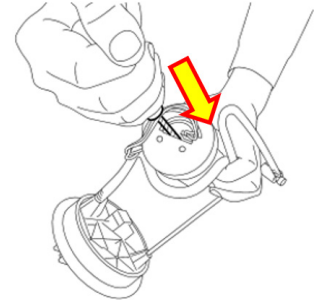

- Using the flat tip screwdriver (or equivalent) wrapped with a protective tape, press on the fuel pump and remove the fuel pump from the fuel filter assembly.
- **IMPORTANT:** Confirm the o-ring is not stuck in the fuel filter bore after removing the fuel pump. If needed, use a rubber-tipped or plastic (non-marring) pick tool to **CAREFULLY** remove it without scratching the filter assembly bore.

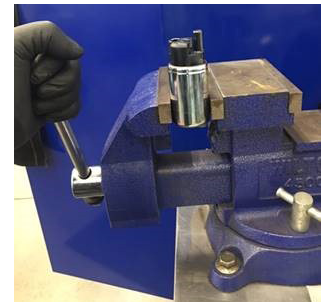

Plastic Non-Marring Pick Tool



IMPORTANT: Remove the o-ring and spacer from the original fuel pump. The spacer is reused. Put the removed pump in a vise and crush it as shown above to eliminate any chance of it being reused.

- Transfer the white plastic spacer (B) to the new pump and install the new o-ring (A) from the kit to hold the spacer in place. **It is CRITICAL for the bushing and NEW o-ring to be installed on the new pump in the proper order.** Always lubricate the new o-rings with gasoline.

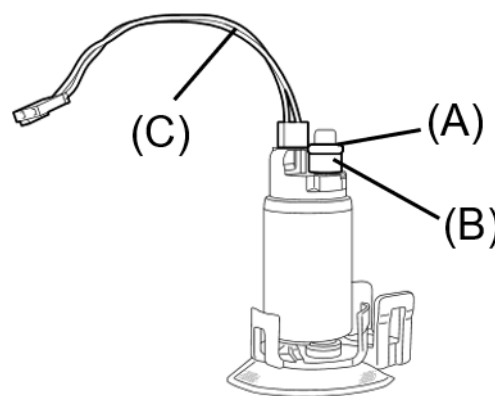
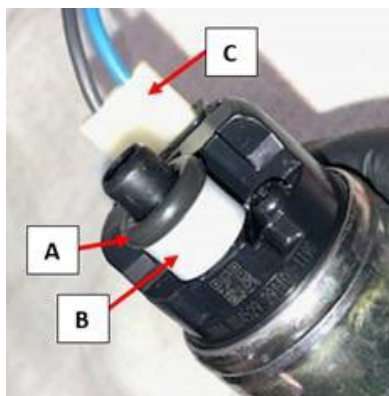

Continued...

8. Install the new fuel pump into the fuel filter assembly. Using the image here as a guide, lay the partially reassembled pump assembly on the bench horizontally and insert the new pump into the fuel filter assembly. Using both hands, CAREFULLY press the new pump and filter assemblies together until a “click” is heard from ALL of the new fuel pump’s retaining claws. If the new pump does not fully seat and lock into position, make sure the old o-ring (A) is not still in the bore as shown above. See **Appendix B** starting on pg. 48 for more information and a video on this **CRITICAL** step.

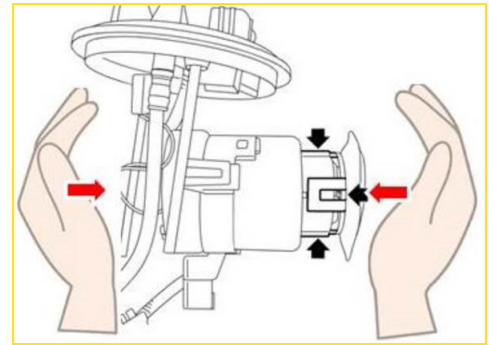

- Install the fuel filter assembly to the fuel chamber assembly. Position tube (A) and spring (B) for the fuel filter assembly as shown in the figure.
- Confirm the fuel tube routing and make sure all the claws securing the fuel chamber to the fuel filter assembly are fully engaged as shown in the photos shown below.

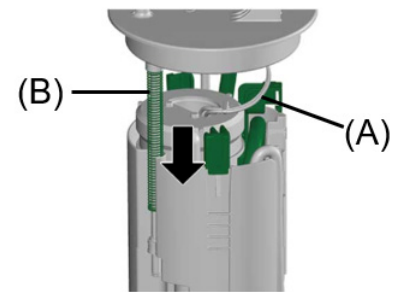

NOTE: In the images below, a section of the fuel chamber has been cut away to make the fuel pipe routing visible for reference. Normally, these fuel pipes are inside the chamber and not visible except at the top.

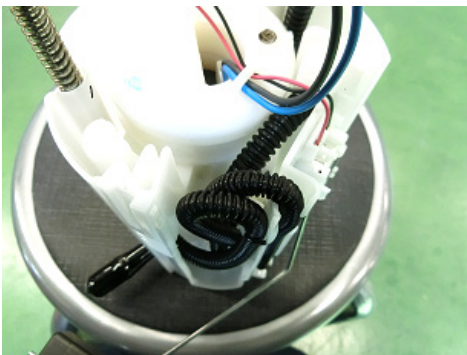

ALWAYS inspect closely for any seepage or leaks around ALL fuel delivery tube connections removed as part of this repair (including those under the hood if fuel was drained) and around the ring nut.

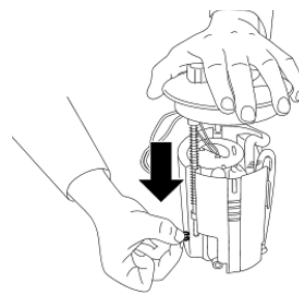

IMPORTANT: Confirm this fuel hose runs UNDER the retaining claw when installing the pump / filter assembly back into the fuel chamber as shown here.

- Secure the fuel tube to the outside of the fuel chamber and reconnect it at the bottom.
- Push the fuel filter assembly in the direction of the arrow to compress, and install the new clip supplied in the kit.

Continued...

9. **CAREFULLY** refit the fuel level sensor assembly to the fuel chamber. Put the (thinner) fuel lever sensor wires into the 2 retaining clips first followed by the fuel pump wires **IN THAT ORDER**.

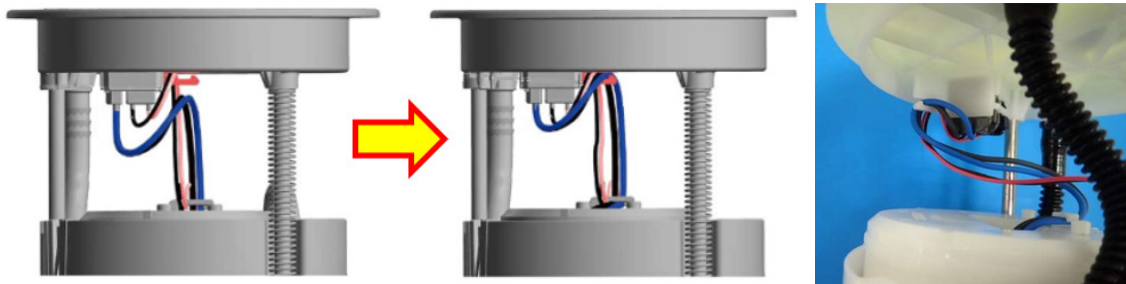

10. **CRITICAL: ALL** surfaces of the new pump assembly o-ring, top gasket, underside of the ring nut along with the surfaces described and shown below: fuel tank neck rim (A) pump flange top and bottom faces (B) and (C) must be thoroughly wiped clean and completely dried BEFORE re-installation. This will help prevent the pump from turning with the ring nut during final tightening.

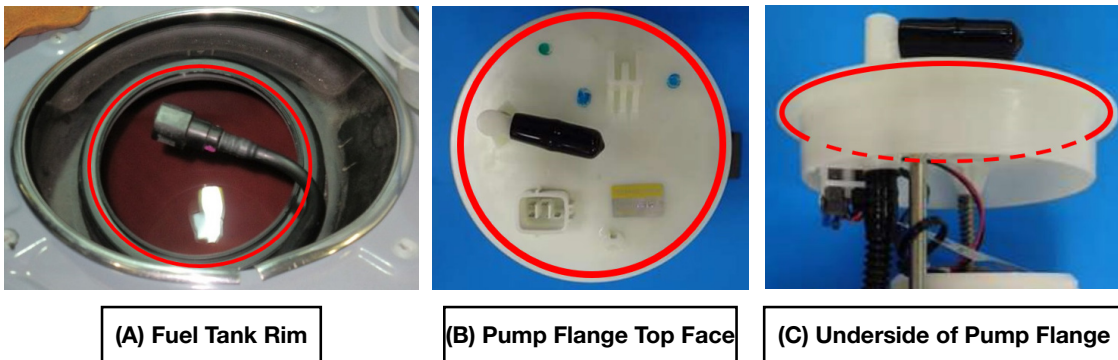

- Use CAUTION to keep the fuel level sensor arm from contacting the fuel tank opening. If the arm were to become bent, the fuel gauge may not read properly.

11. **CAREFULLY** reinstall the fuel pump assembly into the tank using the new gasket included in the kit.

- **CRITICAL:** DO NOT OVERLOOK RECONNECTING THE JET PUMP FUEL TUBE AT THE BOTTOM OF THE FUEL CHAMBER.
- After connecting the jet pump fuel tube, **CAREFULLY** lower the fuel pump assembly into the tank and in the orientation shown in the photo below.

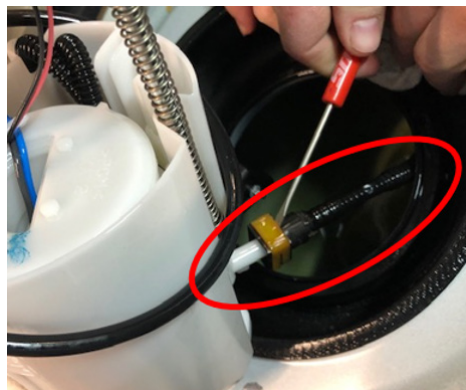

Continued...

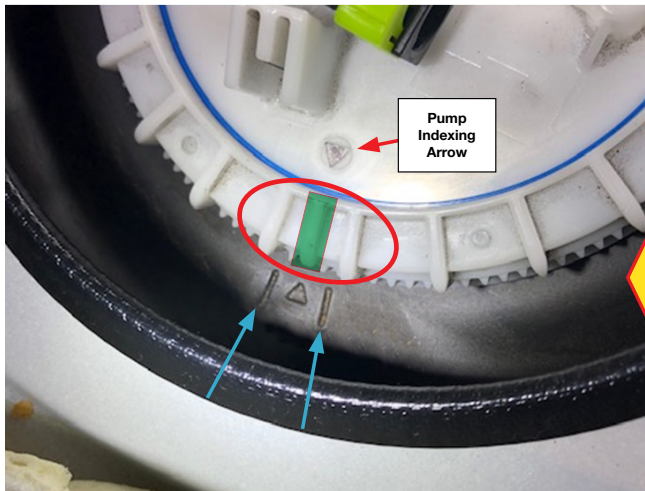

IMPORTANT: This photo shows the NEW ring nut and (Blue) seal plate included in the kit already in place. The ASCENT ring nut thread starting point is identified by the 3 "teeth" close together (RED circled). Align the center (Green) tooth (position mark) with the triangle Δ mark between the molded-in hash marks on the tank (Blue arrows).

- **IMPORTANT:** ALWAYS use the new gasket and blue ring nut seal plate included in the kit.
- The photo above shows the thread STARTING POINTS for the ring plate and fuel tank. There is a second set of molded-in hash marks 90 degrees CLOCKWISE from the starting point hash marks which are the FINISHING POINT (End Range) hash marks shown as (c) in the illustration below. See Appendix C starting on pg. 51 for more information and a video on this CRITICAL step.
- **IMPORTANT:** Before tightening the ring nut:
 - Make sure the fuel delivery tube is ON TOP of the tool and not pinched under it
 - Make sure the tool fits down fully and squarely onto the ring nut.
- Using the ring nut tool, and the illustrations below as a guide, SLOWLY tighten the ring nut ONE FULL TURN then continue until (b) is within the range of the End Range hash marks (c). **NOTE:** (b) MUST be within the End Range hash marks for the ring nut to be fully tightened.
- **CRITICAL:** While tightening the ring nut, make sure the fuel pump does not rotate with the ring nut otherwise, the fuel level sensor and the jet pump fuel tube may become damaged. Always keep the Pump Indexing Arrow; (e) below and the fuel tank ring nut start mark (a) below aligned.

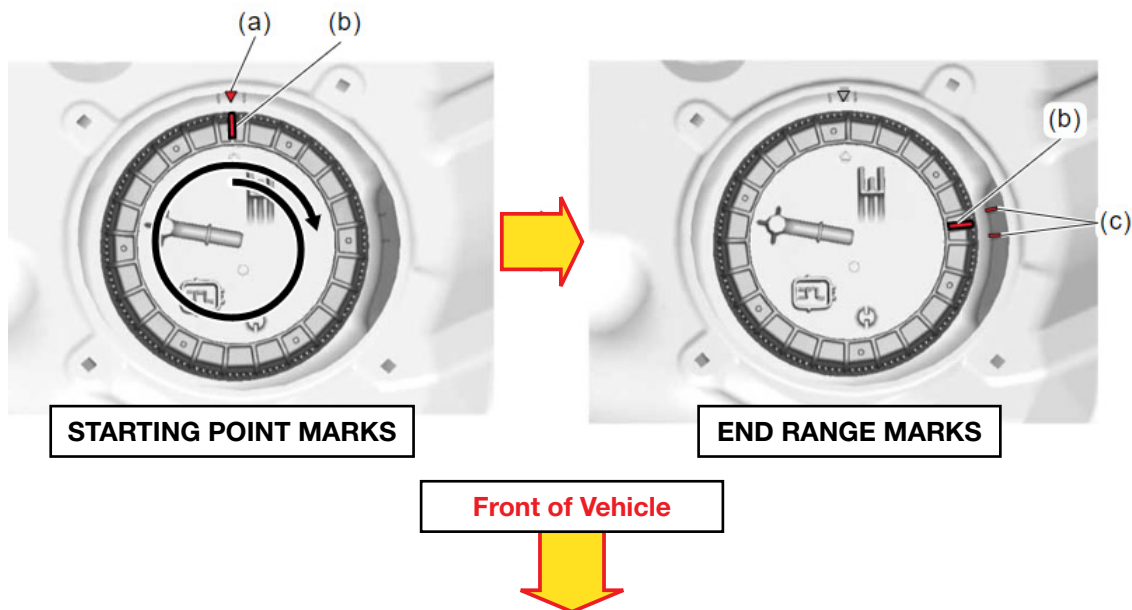

Continued...

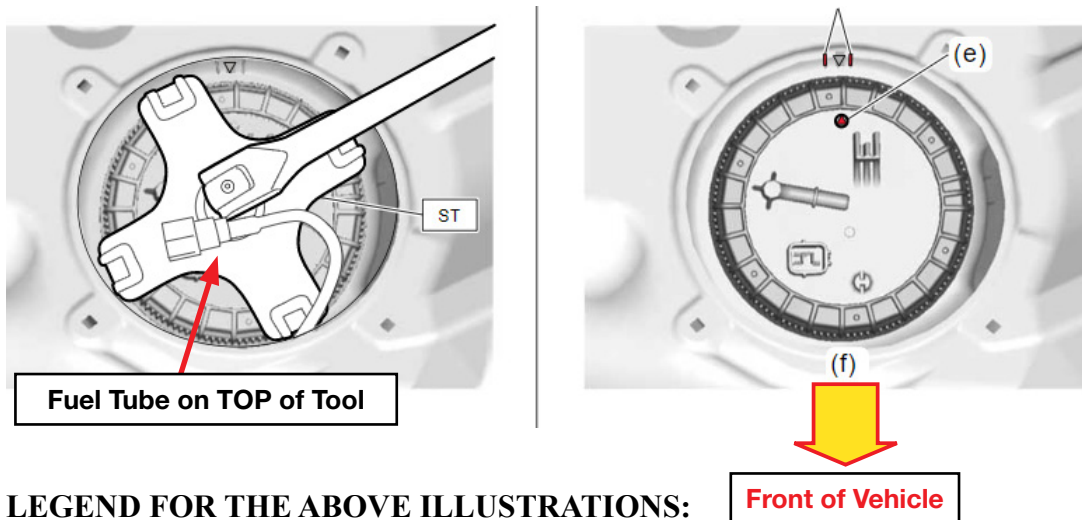

LEGEND FOR THE ABOVE ILLUSTRATIONS:

- (a) Ring nut installation position start mark (on fuel tank)
- (b) Position mark (on ring nut)
- (c) Ring nut installation position end range hash marks (on fuel tank)
- (d) Fuel pump installation position range hash marks (on fuel tank)
- (e) Position (Index) mark (for fuel pump)
- (f) Toward FRONT of vehicle

- **NOTE:** In a case where there is difficulty getting the ring nut threads started onto the fuel tank threads, align the starting points, install the ring nut wrench then press down firmly by hand on the ring nut wrench to “jump” the ring nut thread past the interference point. A “pop” sound will occur, the ring nut should now be parallel to the top of the fuel tank and able to be tightened normally.

CRITICAL: Using a caliper with depth gauge, measure the dimension in 3 positions between the top of the ring nut and the top of fuel tank as shown in the illustration below. Confirm the measured values of dimensions (D) are 23.8 ± 2.5 mm (0.937 ± 0.098 in.).

LEGEND:

- (A) Caliper with depth gauge
- (B) Ring nut
- (C) Fuel tank
- (D) Dimension of ring nut and top of fuel tank
- (E) Measuring point
- (F) Toward FRONT of vehicle

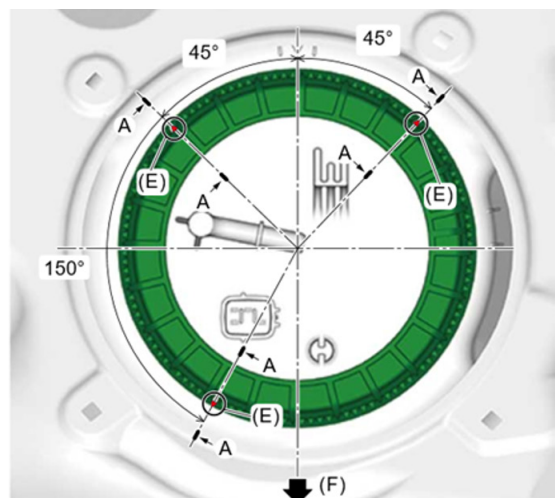
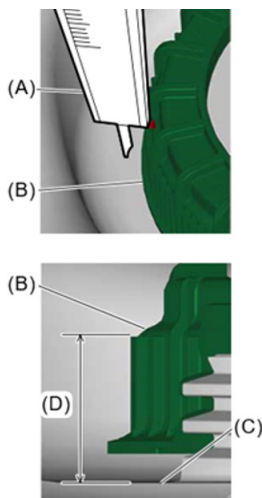

CAUTION:

- If the difference between any of the three measurements exceeds ± 1.5 mm or $.060$ inch, loosen and re-tighten the ring nut to correct any cross-threading.
- If the ring nut or fuel pump gasket are deformed, cracked or damaged, they **MUST** be replaced.

Continued...

- Remove and discard the plastic temporary plug from the fuel delivery pipe and re-connect the pipe to the fuel pump outlet tube. Make sure the connector is all the way onto the outlet tube then lock the slider. Tug on the fuel delivery pipe to be sure it is fully locked in place.

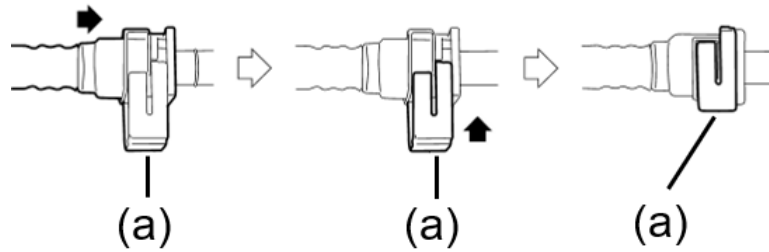

IMPORTANT REMINDERS: Discard the removed temporary fuel line plug as it is a one-time use item. Reusing the plug may damage the connector's internal o-ring and cause a fuel leak.

- Ensure both the pipe and tube are clean and dry
- If the slider does not move easily, confirm the pipe is engaged on the tube
- ALWAYS confirm the pipe is fully engaged after connecting and check for any leaks

12. Reconnect the harness connector to the fuel pump.

13. Reconnect the ground cable and harness connector to the battery sensor. While supporting the sensor with one hand, torque the 12mm ground cable nut to 7.5 Nm (5.5 ft. lbs.).

14. Turn on the ignition switch to run the fuel pump. The engine does not need to be started. Check closely for any leaks around ALL fuel delivery tube connections removed as part of this repair (including those under the hood if fuel was drained) and around the ring nut.

15. Reinstall the inspection cover.

16. Reinstall the r/rear second row seat and trim in reverse order of removal. Torque the retaining bolts to 53 Nm (39 ft. lbs.) Make sure the seat belt buckles are properly positioned.

17. Return any removed fuel back to the vehicle.

18. Deodorize the vehicle interior as necessary.

END OF ASCENT SERVICE PROCEDURE

Continued...

CLAIM REIMBURSEMENT AND ENTRY PROCEDURES:

Credit to perform this recall will be based on properly completed repair order information. Retailers may submit claims through Subarunet.com.

Labor Description	Labor Operation #	Applicability	Labor Time	Fail Code	Claim Type
WRD-20 Complete Fuel Pump Assembly Replacement	B186-943	Legacy, Outback, Impreza	0.7	WRD-20	RC
		Ascent	0.9		
WRD-20 Fuel Pump Kit Replacement	B186-941	Legacy, Outback, Impreza	0.9		
		Ascent	1.1		
Drain Fuel Tank To 2/3 (if required)	C186-945	Legacy, Outback, Impreza	0.2		
Drain Fuel Tank To 2/3 (if required), Includes Intercooler R&R		Ascent	0.5**		
**NOTE: .5 can be claimed on Ascent only when intercooler R&R is required to use the 18471AA000 fuel pipe adapter for draining the fuel tank. Once the 42099FL030 adapter is available to drain the tank by connection at the fuel pump, the Labor Time will be reduced to .2 hrs.					

IMPORTANT NOTES:

- Each retailer will be supplied two (2) of each of the following special tools at “no charge” when they become available.
 - 42099FL030 Fuel Pipe Adapter
 - 42099CA010 Fuel Tank Cap Legacy / Outback
 - 42099FL020 Fuel Tank Cap Ascent/ Impreza
 - SOA635161 Hose- Fuel See **APPENDIX A** starting on pg. 43 for more information.
- Each retailer will receive a miscellaneous credit on their parts statement for:
 - Bulk 5/16” Fuel Hose, 10 ft- Quantity of four (4)
 - Brass Hose Adapter- Quantity of four (4)
 - Fuel Hose Clamps- Quantity of eight (8)

Continued...

CALIFORNIA “VEHICLE EMISSION RECALL - PROOF OF CORRECTION” CERTIFICATE

The California Air Resources Board and the Department of Motor Vehicles Registration/Recall Program requires that all emission related Recall/Campaign or Service Program repairs be completed before a vehicle registration is renewed. Please provide owners of vehicles registered in the state of California a completed “Vehicle Emission Recall - Proof of Correction” certificate. Vehicle owners should be advised to retain this certificate because the California Department of Motor Vehicles may require they provide proof this service program repair has been completed.

Additional certificates are available through normal parts ordering channels using part number MSA6P1301. Quantity 1 = 1 booklet of 50 certificates.

SERVICE PROGRAM IDENTIFICATION LABEL:

Type or print the necessary information on a Campaign Identification Label. The completed label should be attached to the vehicle’s upper radiator support. Additional labels are available through normal parts ordering channels. The part number is **MSA6P1302**, which comes as one sheet of 20 labels.

Part Number	Applicability	Description	Order Quantity
MSA6P1302	All Models	Campaign Completion Labels (contains one sheet of 20 labels)	1

IMPORTANT REMINDERS:

- SOA strongly discourages the printing and/or local storage of service information as previously released information and electronic publications may be updated at any time.
- Always check for any open recalls or campaigns anytime a vehicle is in for servicing.
- Always refer to STIS for the latest service information before performing any repairs.

Continued...

APPENDIX A

Alternate Procedure for Draining the Fuel Tank using Hose Adapter SOA635161.

The following information provides photo instruction for using the **SOA635161** fuel adapter hose (1 of the 2 supplied) and **42099AE000** fuel line release tool to drain fuel from the tank when necessary. The adapter connects to the hard metal fuel supply pipe in the engine compartment. In addition, a readily available barbed hose connection nipple, 5' length of 5/16" fuel hose, 2 small fuel line hose clamps and a gasoline safety can are required.

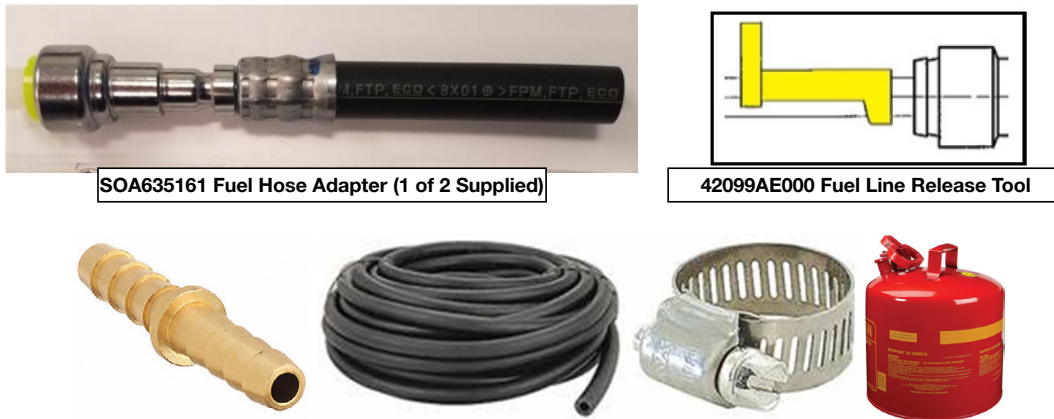

Assemble the drain hose by inserting one end of the barbed nipple into the special tool adapter hose. Insert the other end of the nipple into one end of the 5' length of 5/16" fuel hose. **IMPORTANT:** For extra safety, hose clamps are recommended on **BOTH** these connections. Put the other end of the bulk fuel hose into the gasoline safety can. In-Use photos of the drain hose assembly are supplied below.



Locate and remove the fuel pump fuse in the under-hood fuse box (M/B). Release the fuel pressure by starting the engine and allowing it to run until it stalls. **NOTE:** Even after the engine stalls, there will still be a small amount of residual pressure left in the fuel system. Crank the engine another 5 seconds with the starter to reduce it.

Use the **42099AE000** release tool as shown here to remove the fuel supply hose from the hard metal supply pipe coming from the tank.

IMPORTANT: Place a shop cloth over the connection point while sliding the hose off the supply pipe and another in the area underneath the connection point to catch any remaining fuel in the hose or pipe when the connection is opened.

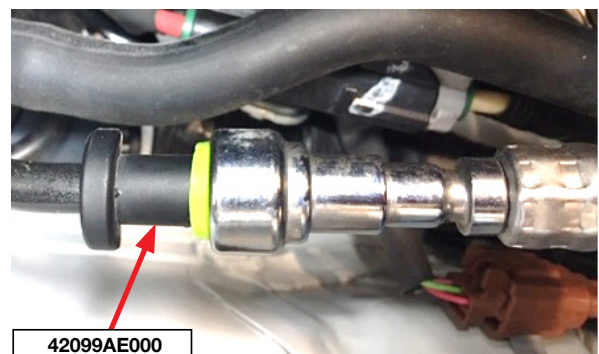

Additional important steps for this procedure are supplied after the reference photos below. They detail the connection points and proper hose routing for each application when draining fuel from Legacy / Outback, Impreza and Ascent using one of the **SOA635161** fuel hose adapter tools.

Continued...

LEGACY / OUTBACK (locations are the same for 2.5L and 3.6L models):

Top view, looking down over l/side of engine compartment. Close-up of hose adapter installed between strut tower and brake fluid reservoir.



Overall top view to better show connection point location.



Hose installation complete and ready for draining.



Continued...

IMPREZA:

Top view, looking down over r/front of engine compartment. Close-up of hose adapter installed.

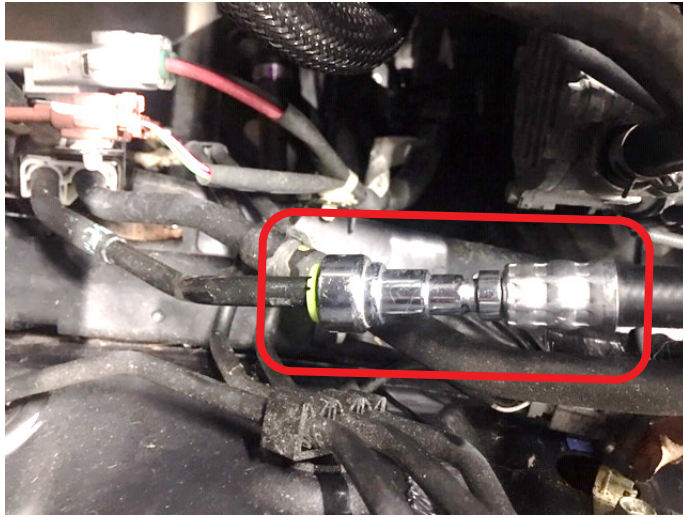

Overall top view to better show connection point location between intake duct and brake piping.



Hose installation complete and ready for draining.

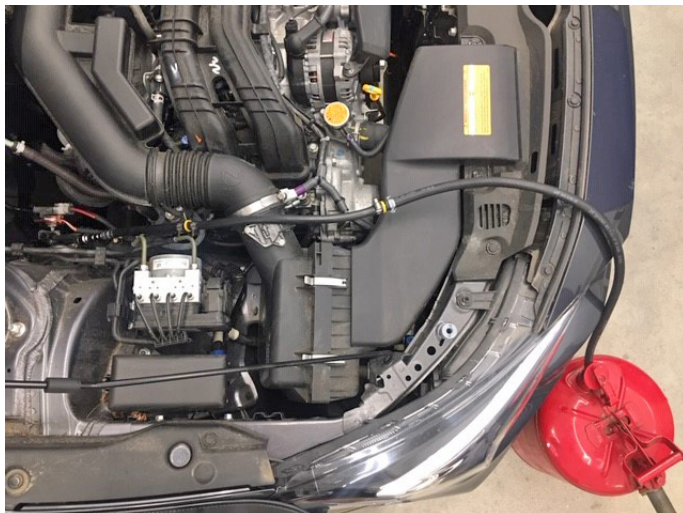

Continued...

ASCENT:

Top view, looking down over r/front of engine compartment. Close-up of hose adapter installed.

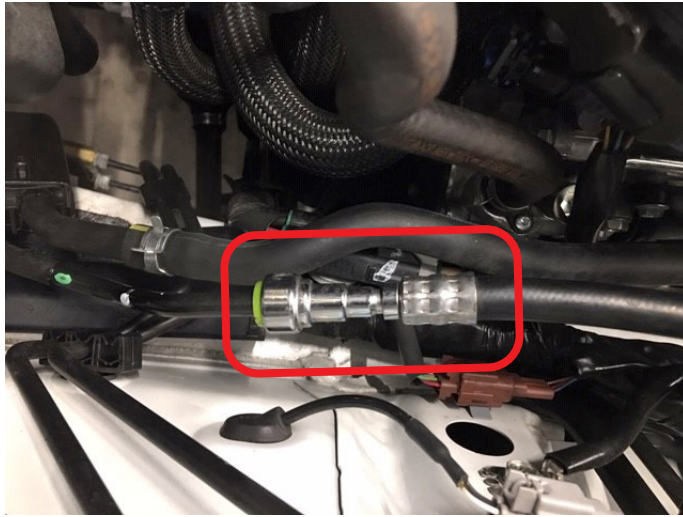

Overall top view to better show connection point location.



Hose installation complete and ready for draining.



Continued...

- After connecting the drain hose assembly securely, reinstall the fuel pump fuse, connect the SSM4 and turn the ignition ON.
- From the Active Test item menu, select Fuel Pump Relay to operate the fuel pump. Drain the fuel tank down until the fuel gauge reads at or below 2/3 full.
- Remove the fuel line adapter using the fuel line release tool from the metal fuel supply pipe while holding a shop cloth under the connection to catch any residual fuel spillage.
- Hold the fuel line adapter and hose up together with a shop cloth as you move it away from the car to prevent any spillage. Allow any residual fuel in the hose to drain into the storage container.
- Ensure the metal fuel supply pipe and vehicle fuel line are both clean and dry.
- Reconnect the engine fuel line connector back onto the metal fuel supply pipe and confirm it is fully engaged by lightly tugging on it.
- Proceed with fuel pump replacement as outlined previously in this bulletin by vehicle type.

IMPORTANT: Be sure to check this fuel connection for any leaks once the fuel pump replacement is complete. There must be NO fuel leaks of any type from this or ANY fuel line connection.

Continued...

APPENDIX B

Replacement Fuel Pump Component Installation Tips

These tips have been assembled to help Technicians successfully complete these repairs quickly and accurately by identifying and clarifying specific repair areas which could lead to concerns after reassembly. These conditions may include fuel supply concerns resulting from o-rings that are:

- Damaged or torn
- Out of position, pinched or stretched
- Improperly installed in relation to the bushing (o-ring and bushing positions reversed).

CRITICAL STEP: After removing the original fuel pump component from the filter housing, ALWAYS confirm the original o-ring either came out with the pump or, it is removed from its bore BEFORE attempting to install the new fuel pump as shown here.

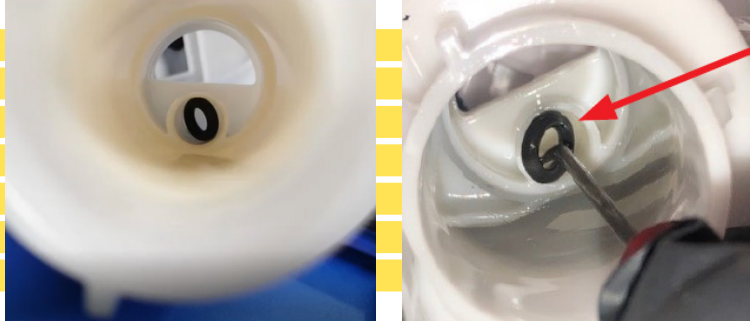

Both the illustration and picture below show the proper configuration of the fuel pump, bushing and o-ring prior to reassembly. The new o-ring is positioned for proper sealing on top of the bushing.

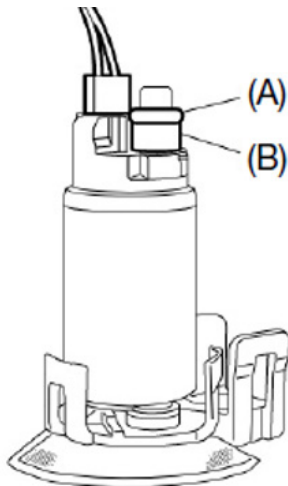

- A - NEW O-Ring Supplied in the Parts Kit
- B - Bushing (Reused from Original Pump)

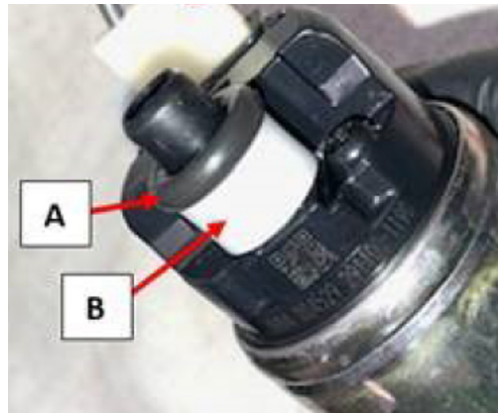

The images below are snapshots from a video which shows how the o-ring can become compromised when repeated attempts are made to press / force the new fuel pump back into the filter housing. A small “window” was cut into the filter housing used here to visually demonstrate how when repeated attempts are made to get the new pump to engage the retaining claws of the original filter housing, the o-ring can become dislodged from the fuel pump outlet tube and damaged. The new o-ring shown below has been colored YELLOW to make it easier to see.

Continued...

Three prime reasons for Technicians to have difficulties with getting the new pump to fully seat / latch back into the filter housing properly are:

- The original fuel pump o-ring is still in place in the filter housing bore
- The new o-ring was not properly lubricated with gasoline prior to attempting the reassembly
- Repeated attempts to get the pump fully seated have caused the o-ring to come off the outlet tube of the fuel pump as shown below.

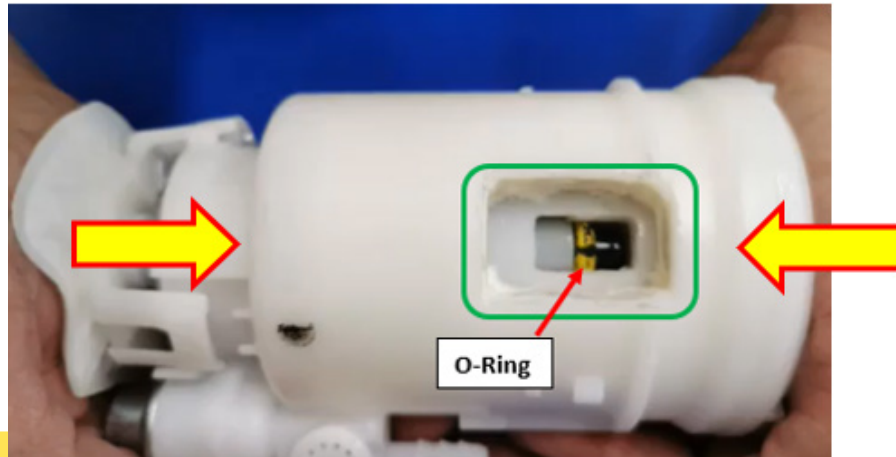

CRITICAL TIP: Align and press the new fuel pump **FIRMLY, SQUARELY** and **STRAIGHT** into the filter housing in **ONE** smooth, continuous motion.

VERY IMPORTANT: When pressing the fuel pump into the filter housing, if it does not seat properly with all the retaining clips “clicking” into position **MUST** be removed from the filter housing, the bushing and o-ring “reset” and the o-ring re-lubricated before trying again. Do this with each attempt to assemble until successful. If the o-ring becomes pinched, stretched or otherwise damaged, it **MUST** be replaced.



VERY IMPORTANT REMINDER: When installing the new fuel pump into the filter housing, it is **CRITICAL** to press the new fuel pump **FIRMLY SQUARELY** and **STRAIGHT** into the filter housing in **ONE** smooth, continuous motion. Misalignment will prevent the o-ring from seating squarely in the bore and when the hand pressure is released to try again, the o-ring can easily become dislodged from the fuel pump outlet tube resulting in the mis-alignment shown above and in the illustrations below.

Continued...

The **RED** circles represent a cross-section of the o-ring.

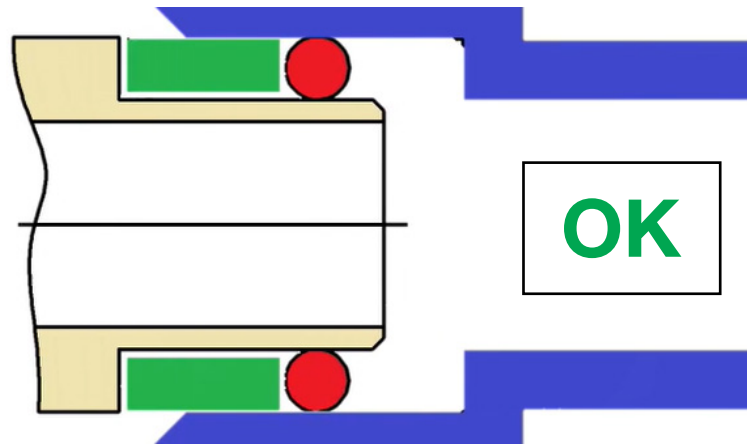

The new fuel pump is being pressed firmly and squarely into the filter housing bore and successfully “clicks” into place.

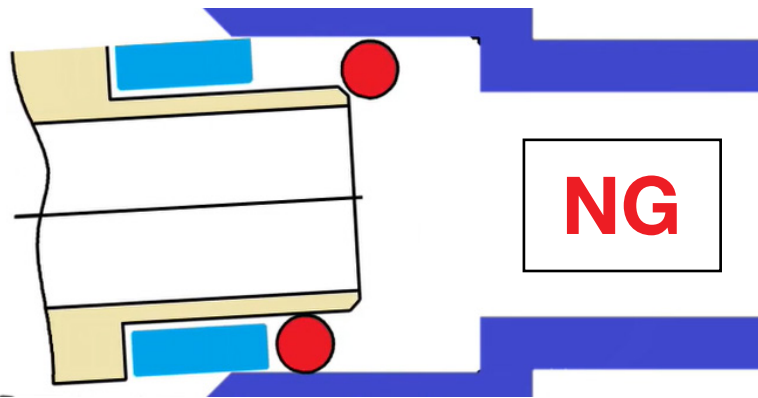

Here, the new fuel pump is being pressed into the filter housing bore at an angle which will likely result in the outlet tube butting against the shoulder of the bore the o-ring seals against followed by repeat attempts which often end up with the o-ring becoming dislodged.



Installation video of the new fuel pump component into the filter housing

Continued...

APPENDIX C

Ascent and Impreza Fuel Pump Assembly Ring Nut Installation Tip

Fig. 1 shows the Ring Nut installed on the tank threads but cross-threaded / mis-aligned. Attempting to tighten the Ring Nut with the tool when mis-aligned like this will likely damage the threads on both parts.

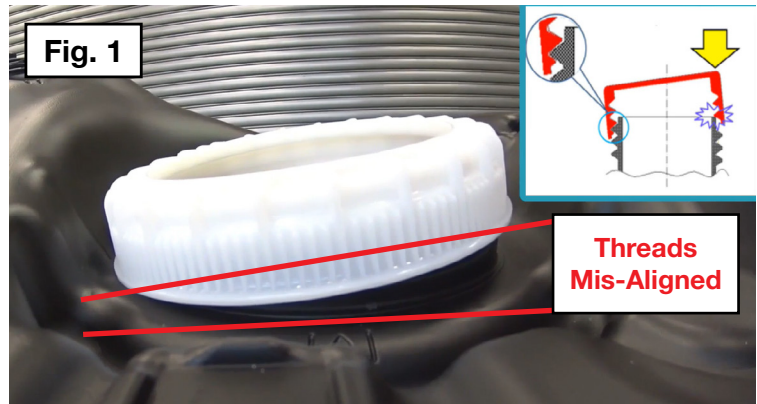
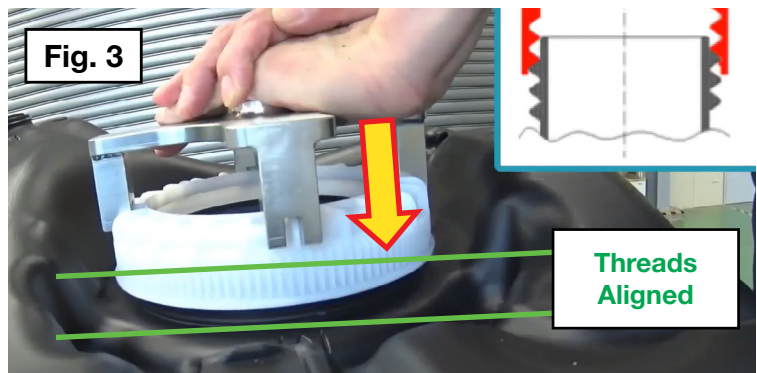

Fig. 2 shows the Special Tool installed onto the Ring Nut making the mis-alignment easier to identify before attempting to tighten it.



Figs. 3 & 4 show the Special Tool installed onto the Ring Nut then, a firm, sharp, **straight downward** force being applied to the tool to "jump" the threads resulting in proper alignment and start to a normal, successful tightening procedure.



Continued...



Hints for getting the new retaining Ring Nut threads video properly engaged onto the fuel tank threads.

URGENT
IMPORTANT SAFETY RECALL
This notice applies to the VIN below



PO Box 9103
Camden, NJ 08101-9877
844-373-6614
www.subaru.com

Subaru Safety Recall WRD-20
NHTSA Recall ID 20V-218
June 2020

Dear Subaru Owner:

This notice is sent to you in accordance with the National Traffic and Motor Vehicle Safety Act.

SUBARU OF AMERICA, INC. has decided that a defect, which relates to motor vehicle safety, exists in certain 2019 model year Ascent, 2019 model year Impreza, 2019 model year Legacy and 2019 model year Outback vehicles.

You received this notice because our records indicate that you currently own one of these vehicles.

REASON FOR THIS SAFETY RECALL

Your vehicle may be equipped with a low-pressure fuel pump assembled with an impeller that may become deformed. Over time, the impeller may become deformed enough to interfere with the body of the fuel pump, potentially causing the low-pressure fuel pump to become inoperative.

SAFETY RISK

If the low-pressure fuel pump becomes inoperative, the check engine warning light or malfunction indicator light may illuminate, and/or the engine may run rough. An inoperative fuel pump may result in the engine stalling without the ability to restart the vehicle, increasing the risk of a crash.

WHAT SUBARU WILL DO

Subaru will replace the fuel pump at no cost to you.

What You Should Do

You should contact any authorized Subaru retailer (dealer) for an appointment to have this safety recall repair performed, at no cost to you.

HOW LONG WILL THE REPAIR TAKE?

The time required to replace the fuel pump for Impreza, Legacy and Outback vehicles is approximately 1 hour and 10 minutes. The time required to replace the fuel pump for Ascent vehicles is approximately 1 hour and 40 minutes. Your retailer can provide you with a better estimate of the overall time for this service visit, as it may be necessary to make your vehicle available for a longer period of time.

For your convenience, your retailer may provide you with a loaner or rental vehicle, at no cost to you, until the repair is complete.

CALIFORNIA REGISTERED OWNERS

The California Air Resources Board requires that emission related campaigns be completed prior to California's vehicle registration renewal process; without this repair, you will not be able to register your vehicle during your next annual registration. Upon completion of this campaign, your California dealer will complete and provide you a "Proof of Correction Certificate." If required, present the certificate to the California Department of Motor Vehicles (the "DMV") when renewing your California registration as proof of campaign completion. If the DMV does not request the certificate, we recommend that you keep it for your records.

In addition, the State of California requires that every vehicle must pass an emission test (SMOG Check) every two years and before it is sold. **Without the repair we are providing at no charge, your vehicle may not pass this test.**

Continued...

OWNER INFORMATION

Government regulations require that recall notifications be sent to the last known owner of record. That information is based primarily on state registration and title data. If you are a lessor of this vehicle, federal If you have moved or sold your vehicle, please update this information online at www.subaru.com, select 'Customer Support,' then select 'Address Update' or 'Ownership Update' from the "Quick Links" menu.

IF YOU HAVE PREVIOUSLY PAID FOR A REPAIR

If you have already paid for repairs associated with this condition, you may be eligible for reimbursement. Reimbursement consideration will be based on the amount an authorized Subaru retailer in your area would charge for the same repair.

Please send the original service repair order, which has the name of the repair facility, date of repair, mileage at the time of repair, complete 17-digit vehicle identification number (VIN), and your name, with correct mailing address and telephone number to the address listed below.

Subaru of America, Inc.
Customer Advocacy Department, Attention: WRD-20 Recall
P.O. Box 9103, Camden, NJ 08101-9877

Please send original receipts only and retain a photocopy for your records. Please be assured that we will attempt to process your reimbursement request as quickly as possible, but it may take up to 60 days for this process to be completed.

IF YOU NEED FURTHER ASSISTANCE:

To locate the nearest Subaru retailer, you can access our website at www.subaru.com and select 'Find a Retailer.' For additional information, please go to: <http://www.wrd20.service-campaign.com>.

If you need additional assistance, please contact us directly:

- By e-mail: Go to www.subaru.com and select "Customer Support"
- By telephone: 1-844-373-6614
Monday through Friday between 8:00 a.m. and 7:00 p.m. ET
- By U.S. Postal mail: Write us at Subaru of America, Inc.
Attn: Customer Advocacy Department
P.O. Box 9103, Camden, NJ 08101-9877

To subscribe to the NHTSA Recall Notification email System, please go to:
<https://www-odi.nhtsa.dot.gov/nhtsa/subscriptions>.

Please contact us immediately if the Subaru retailer fails or is unable to make the necessary repairs free of charge.

You may also contact the Administrator, National Highway Traffic Safety Administration (NHTSA), 1200 New Jersey Ave., SE, Washington, DC 20590 or call the toll-free Vehicle Safety Hotline at 1-888-327-4236 (TTY: 1-800-424-9153) or go to <http://www.safercar.gov> if you believe the Subaru retailer has failed or is unable to remedy your vehicle without charge within a reasonable amount of time.

Your continued satisfaction with your Subaru is important to us. Please understand that we have taken this action in the interest of your safety and your vehicle's proper operation. We sincerely apologize for any inconvenience this matter may cause and urge you to schedule an appointment as soon as possible.

Sincerely,
Subaru of America, Inc.

Notice to Lessors:

The lessor of a vehicle who receives this letter must provide a copy of it to the vehicle lessee(s) within 10 business days from receipt. The lessor must also keep a record of the lessee(s) to whom this letter is sent, the date sent, and the applicable vehicle identification number (VIN). (For the purposes of this section, a lessor means a person or entity that in the last twelve months prior to the date of this notification has been the owner, as referenced on the vehicle's title, of any five or more leased vehicles. A leased vehicle is a vehicle leased to another person for a term of at least four months.)

A subsidiary of SUBARU CORPORATION