

- ATTENTION:**
- GENERAL MANAGER
 - PARTS MANAGER
 - CLAIMS PERSONNEL
 - SERVICE MANAGER

IMPORTANT - All Service Personnel Should Read and Initial in the boxes provided, right.

© 2020 Subaru of America, Inc. All rights reserved.



QUALITY DRIVEN® SERVICE

SERVICE PROGRAM BULLETIN

APPLICABILITY: 2015-2016MY Legacy 2.5L
2015-2016MY Outback 2.5L

NUMBER: WUJ-95R

DATE: 02/11/20

SUBJECT: Exhaust Pipe Front (EPF) Bellows Cracking

REVISED: 03/24/20

INTRODUCTION:

Subaru of America, Inc. (Subaru) is initiating a service campaign for certain 2015-2016MY Legacy and Outback 2.5L models which may experience an exhaust noise and/or odor coming from cracks at the bellows section of the front exhaust pipe which includes the catalytic converter. A leak occurring at the front exhaust pipe may result in deterioration of emission performance. As a result, the vehicle may fail to meet emission levels certified by the EPA and/or California ARB.

AFFECTED VEHICLES:

Vehicles included in this service campaign are 2015-2016 Legacy and Outback 2.5L. This recall will affect approximately 243,750 vehicles. Coverage for all affected vehicles must be confirmed by using the Vehicle Coverage Inquiry function on subarunet.com. The affected VINs will be made available in phases, as the owner notification letters are scheduled for release. Please refer to the ‘Owner Notification’ section of this bulletin for more information.

Model Year	Carline	Affected Production Dates
2015-2016	Legacy	12/16/2013 - 9/30/2015
2015-2016	Outback	12/09/2013 – 9/30/2015

DESCRIPTION OF THE REPAIR:

Subaru retailers will replace the front exhaust pipe.

RETAILER RESPONSIBILITY:

Retailers are to promptly perform this repair on all affected vehicles in their inventory. Additionally, whenever a vehicle subject to this service program is taken into inventory or in for service, necessary steps should be taken to ensure the repairs have been made before selling or releasing the vehicle.

CAUTION: VEHICLE SERVICING PERFORMED BY UNTRAINED PERSONS COULD RESULT IN SERIOUS INJURY TO THOSE PERSONS OR TO OTHERS.

Subaru Service Bulletins are intended for use by professional technicians ONLY. They are written to inform those technicians of conditions that may occur in some vehicles, or to provide information that could assist in the proper servicing of the vehicle. Properly trained technicians have the equipment, tools, safety instructions, and know-how to do the job correctly and safely. If a condition is described, DO NOT assume that this Service Bulletin applies to your vehicle, or that your vehicle will have that condition.

Subaru of America, Inc. is ISO 14001 Compliant

ISO 14001 is the international standard for excellence in Environmental Management Systems. Please recycle or dispose of automotive products in a manner that is friendly to our environment and in accordance with all local, state and federal laws and regulations.

Continued...

OWNER NOTIFICATION:

Affected vehicle owners will be notified in phases based on their physical location, the emissions specification of their vehicle (Cal-spec or Fed-spec), and parts production schedules. Listed in the table below is the current phased mailing plan:

Date	Emissions specification (spec)	Mailing Phase	Assigned Retailers' Facing RDC(s)	Applicable WUJ-95 Kit Part Number	Approximate Quantity
February 2020	California-spec (PZEV)	PZEV 1	Coppell RDC Ontario RDC Portland Lombard RDC	SOA635156	50,000
February 2020	Federal-spec	FED 1	Aurora RDC	SOA635157	16,000
March 2020	Federal-spec	FED 2	SNE, SDC Coppell RDC Ontario RDC Portland Lombard RDC	SOA635157	18,000
April 2020	California-spec (PZEV)	PZEV 2	SNE	SOA635156	27,000
May 2020	California-spec (PZEV)	PZEV 3	SDC	SOA635156	19,000
June 2020	California-spec (PZEV)	PZEV 4	Florence RDC	SOA635156	30,000
July 2020	California-spec (PZEV)	PZEV 5	Aurora RDC Douglasville RDC Lebanon RDC	SOA635156	19,000
August 2020	Federal-spec	FED 3	Douglasville RDC Florence RDC	SOA635157	25,000
September 2020	Federal-spec	FED 4	Lebanon RDC	SOA635157	40,000

This schedule is subject to change based on parts availability.

RETAILER AFFECTED VIN LISTS:

Each Subaru retailer will receive an affected VIN list for each phased mailing from their Zone office as the owner notification letters are released. Vehicles will be assigned to retailers in the affected VIN list as follows. Please note that this logic has recently changed:

1. If there is a preferred retailer on file, the VIN will be assigned to the preferred retailer.
2. If there is no preferred retailer on file:
 - a. Original vehicle owners are assigned to the original selling retailer if their current DMV registration address is within a 50-mile radius of that retailer.
 - b. If the original selling retailer is inactive, the VIN is assigned to the nearest active retailer.
 - c. If the owner is not the original owner, the VIN is assigned to the nearest active retailer.

PART INFORMATION:

During transportation from the supplier, the spacing between the exhaust flanges may change due to vibration. Although the amount of this change is small, it is enough to require more force than normal to install the EPF onto the engine during vehicle assembly. The amount of force may have caused cracking to develop in the bellows section of the EPF resulting in exhaust leakage. Since the area of the leak is upstream of the catalyst, emission system performance may be compromised. In some cases, customers may notice an unusual noise and / or exhaust odor.

Continued...

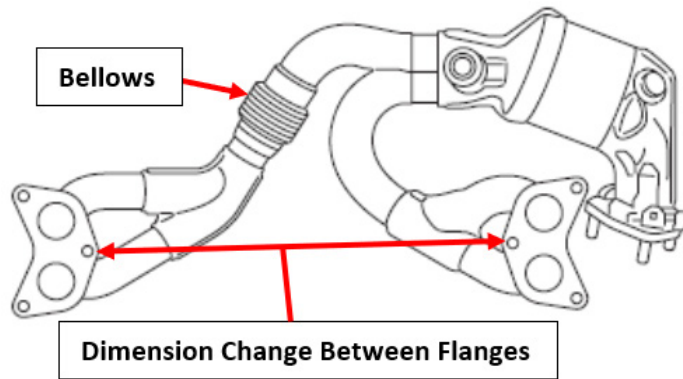

Description	Part Number	Application
Cal Spec. (PZEV) Kit	SOA635156	PZEV (Cal Spec) Vehicles
Fed Spec. Kit	SOA635157	Fed. Spec. Vehicles
Insulation Pad Adhesive	SOA868V9690	Both Fed and PZEV Vehicles

SERVICE PROCEDURE / INFORMATION:

REMINDER: Customer satisfaction and retention starts with performing quality repairs.

The service procedures for removal and reinstallation of the EPF assembly remain unchanged.

See “**APPENDIX A**” beginning on page 8 for additional Helpful Hints.

NOTE: The new EPF kit is supplied without heat shields. The heat shields used on the original EPF will need to be **CAREFULLY** removed along with their fiberglass insulators and transferred to the new part. The kit includes a complete set of replacement fiberglass insulation pads.

EPF heat shield -related repair guidelines are provided below. Always refer to the applicable Service Manual and review the full requirements of the repair being performed. The Service Manual procedures contain information critical to performing an effective repair the first time and every time. This includes but is not limited to: important SAFETY precautions, proper inspection criteria, necessary special tools, required processes and related one-time-use parts needed for a complete and lasting repair.

(3) PREPARATION:

- Record the customer’s radio station presets (and Navigation favorites where applicable) then disconnect the ground cable from the battery sensor.
- Remove the engine under cover.
- **CAREFULLY** disconnect the Air Fuel Ratio and Oxygen Sensor harness connectors.
- Disconnect the center exhaust pipe at the spring bolt connection. New nuts and spring bolts are supplied in the hardware kit but, the springs are to be reused.
- Remove the center bolt from the hanger bracket but do not unhook the exhaust pipe from it yet.
- Loosen / remove and discard the six one-time use EPF flange nuts at the cylinder heads. New nuts are also supplied in the hardware kit.

Continued...

IMPORTANT REMINDER / CAUTION: The EPF assembly is heavy. Use a helper if necessary to avoid dropping it during removal.

- Remove the center exhaust pipe from the EPF. **CAUTION:** The pipe may be hot.
- **Once the EPF has cooled (or if necessary), apply a penetrating oil (e.g. PB Blaster® or equivalent as directed on the product's container) to the sensor threads to help with removal.**
- **CAREFULLY** remove the Air Fuel Ratio and Oxygen Sensors from the EPF assembly.

NOTES:

- Both EPF kits (**SOA635156** for CAL-spec and **SOA635157** for FED-spec. vehicles) include:
 - A new EPF **WITHOUT** heat shields
 - All new fiberglass heat insulation pads
 - 4 new clamps for the small heat shields closest to the cylinder head flanges.
 - A replacement hardware kit for the heat shields and spring nuts / bolts
 - A replacement exhaust gasket kit (cylinder head flange (2), front pipe (1) and center “donut” (1) gaskets).
- Insulation Pad adhesive p.n. **SOA868V9690** **must be ordered separately** and is used to secure the new insulation pads to the inside of the heat shields prior to reassembly. The part number to use for Warranty claim entry is SOA635314 (qty. 1). Each quart-sized (32 oz.) container has a brush applicator cap. **IMPORTANT:** Always keep the cap tightly sealed between uses for longest life. Replace the adhesive if it becomes dried out or cannot be applied properly using the brush.



(4) HEAT SHIELD TRANSFER:

IMPORTANT NOTE: All heat shields are intended to be reused. **USE HAND TOOLS ONLY** when removing them from the EPF to avoid breaking off the retaining studs.

- **ALWAYS** wear proper eye protection
- Use a wire brush to remove any loose rust/scale from the heat shield retaining fasteners.
- Apply a penetrating **lubricant** (e.g. PB Blaster® or equivalent) as directed on the product's container to the heat shield fasteners to help loosen and remove them without breakage.
- In some cases, **VERY CAREFUL** use of a torch or an induction heating tool may be necessary to loosen / remove rusted / siezed heat shield hardware.
- When the fasteners initially begin to loosen, work them back and forth while applying additional penetrant to help lubricate the threads. **TAKING YOUR TIME** during this step will help prevent breaking off fasteners and avoid heat shield replacements. Repeat as necessary until all the heat shields have been removed from the EPF.

IMPORTANT: As each heat shield is **CAREFULLY** removed, **use a permanent marker to outline** the shape and positioning of each fiberglass insulation pad found on the inside of it whenever possible. **A complete set of new insulation pads is included in the EPF kit and ALL are to be replaced at reassembly.**



Continued...

Use a wire brush to remove any insulation and / or adhesive residue. Proper positioning of the new insulation pads is key to achieving a rattle-free repair.

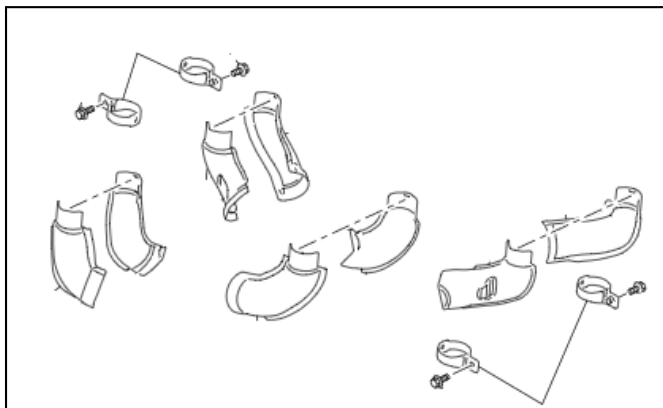
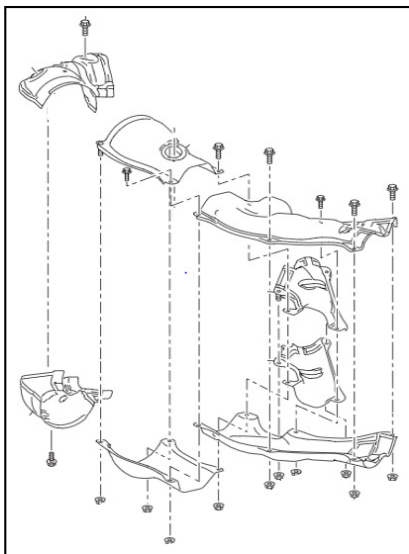

TIP: Replacing the insulation pads and swapping each (pair) of these small shields over to the new EPF one pipe at a time will help avoid confusion.

- Before applying any of the new insulation pads, wipe the inside and outside of the shields clean of any residual oil / penetrant used with a mild solvent on a clean shop cloth. Use caution to not remove the position markings for the replacement insulation pads.

TIP: Have all the stud threads and shields going back onto the new EPF cleaned and their respective heat insulation pads ready to apply. Doing it this way avoids having to open and close the adhesive container repeatedly.

- Remove the brush cap from the adhesive container and apply a small amount of the material to each shield toward the center of where the new insulation pad will be positioned. Marking an outline for where the adhesive should be applied can also be used as shown below.



- For reference, a “dab” or two of adhesive about the size of a silver dollar is plenty. There is no need to cover the entire insulation pad area. Keep in mind, the adhesive is only used to hold the new insulation pads in place during EPF reassembly as they will be held (“clamped”) in position once all the retaining hardware is tightened.
- Apply the adhesive to the shield then press the new insulation pad onto it and all the contours of each shield. Repeat for each remaining shield and insulation pad.

Continued...

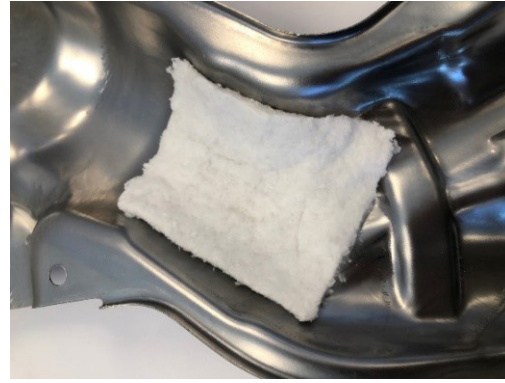

IMPORTANT: Keep the adhesive bottle tightly sealed at all times.

- BEFORE installing the shields onto the new EPF, confirm the new EPF fits into place on the cylinder head exhaust studs properly without any prying or other manipulation.
- When all the insulation pads are in place and proper EPF fit is confirmed, proceed with reassembling the heat shields onto the EPF.

EPF Fastener Torque Specifications:

- Reassemble the exhaust system and install using all the new gaskets and hardware supplied in the kit.

Fastener	Nm	Ft. Lbs.
Cylinder Head Flange Nuts	30	22.1
EPF to Center Pipe	42.5	31.3
Heat Shield Nuts / Bolts / Clamps	13	9.6
Center Pipe Spring Bolt Nuts	18	13.3
Center Pipe Hanger Bolt	35	25.8
Air-Fuel Ratio and O2 Sensor	21	15.5

REMINDER: The exhaust gaskets along with new manifold nuts and exhaust pipe nuts and bolts are all one-time use and **MUST always** be replaced.

- Finish the EPF reassembly in reverse order of removal.

NOTE: The adhesive used for securing the fiberglass heat insulation pads is water-based and odorless. Any residual moisture will be eliminated the first time the new EPF comes up to temperature. For this reason, a slight amount of residual vapor may be noticed on the vehicle's initial re-start.

CLAIM REIMBURSEMENT AND ENTRY PROCEDURES:

Credit to perform this recall will be based on properly completed repair order information. Retailers may submit claims through Subarunet.com.

Labor Description	Labor Operation #	Labor Time	Fail Code	Claim Type
EPF ASSEMBLY R&R INCLUDES: TRANSFER OF ALL METAL HEAT SHIELDS. INCLUDES INSTALLATION OF ALL NEW INSULATION PADS	A122-951	0.7	WUJ-95	RC
EPF ASSEMBLY R&R INCLUDES: ALL THE ABOVE COMBINED WITH THE INSTALLATION OF AT LEAST ONE OR MORE NEW METAL HEAT SHIELDS*	A122-953	0.8		

***NOTE:** This operation may only be used when replacement of one or more new metal heat shield (not to be confused with the white insulation pads) is needed to complete the campaign.

REMINDER: All the white fiberglass heat insulation pads included in the EPF kit are required to be replaced during reassembly of the new EPF.

Continued...

Additional WUJ-95 Claim Submission Information		
Description	Part Number	Application
CAL Spec. (PZEV) EPF Kit	SOA635156	CAL Spec. PZEV Vehicles
FED Spec. EPF Kit	SOA635157	FED Spec. Vehicles
Insulation Pad Adhesive	SOA635314	Both FED and CAL Spec. Vehicles**
Replacement Heat Shields and Insulation Pads	Order individually per VIN and EPC	Both FED and CAL Spec. Vehicles**
**NOTE: Replacement Shields, Pads & Adhesive can be claimed with A122-953 ONLY .		

CALIFORNIA “VEHICLE EMISSION RECALL - PROOF OF CORRECTION” CERTIFICATE

The California Air Resources Board and the Department of Motor Vehicles Registration/Recall Program requires that all emission related Recall/Campaign or Service Program repairs be completed before a vehicle registration is renewed. Please provide owners of vehicles registered in the state of California a completed “Vehicle Emission Recall - Proof of Correction” certificate. Vehicle owners should be advised to retain this certificate because the California Department of Motor Vehicles may require they provide proof this service program repair has been completed.

Additional certificates are available through normal parts ordering channels using part number MSA6P1301. Quantity 1 = 1 booklet of 50 certificates.

SERVICE PROGRAM IDENTIFICATION LABEL:

Type or print the necessary information on a Campaign Identification Label. The completed label should be attached to the vehicle’s upper radiator support. Additional labels are available through normal parts ordering channels. The part number is **MSA6P1302**, which comes as one sheet of 20 labels.

Part Number	Applicability	Description	Order Quantity
MSA6P1302	All Models	Campaign Completion Labels (contains one sheet of 20 labels)	1

IMPORTANT REMINDERS:

- SOA strongly discourages the printing and/or local storage of service information as previously released information and electronic publications may be updated at any time.
- Always check for any open recalls or campaigns anytime a vehicle is in for servicing.
- Always refer to STIS for the latest service information before performing any repairs.

Continued...

“APPENDIX A”: Additional Helpful Hints

IMPORTANT REMINDERS:

- ✓ **ALWAYS** wear eye protection!
- ✓ The EPF's heat shields are stamped stainless steel and have MANY sharp edges. Always use **CAUTION** to avoid nicks, cuts and scrapes.
- When disassembling the heat shields from the original EPF, pay close attention to the two shields with retaining studs made onto them instead of nuts / bolt fasteners. **TAKE YOUR TIME** with these to avoid having to replace the shield(s) due to a broken stud. Use a wire brush to clean the stud threads along with a touch of lubricant before reassembly is recommended.



- Take a minute to test fit the shields covering the catalytic converter section to the new EPF. The photo sequence below shows one of the original EPF's outlet flange studs having clearance between it and the converter shield mounting bracket. The same stud on the new EPF is shown pushing against the edge of the bracket. This caused a mis-alignment of the shield mounting bolt hole and corresponding bracket bolt hole. Some **VERY CAREFUL** manipulation of the mounting bracket restored the proper bolt hole alignment.

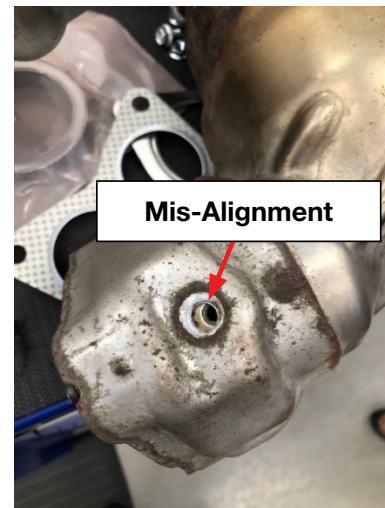
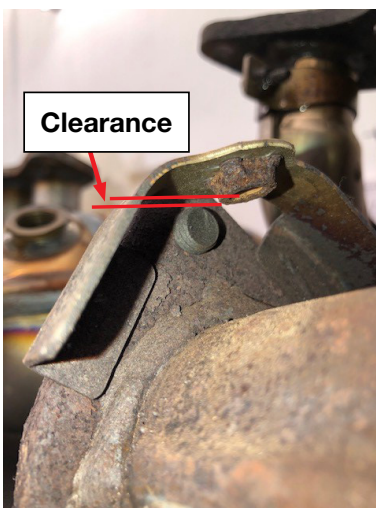

Continued...

- Some reports have been received regarding the mounting bracket tabs as pictured below. Occasionally, the fastener holes in the bracket are not fully aligned with the holes in the center exhaust pipe mounting flange. The pictures show one of the center exhaust pipe mounting studs displacing the bracket tab. If this happens, it may cause the bolt hole for the converter shield to become mis-aligned (or, it may have no effect at all). This condition **MAY** require some **VERY CAREFUL** manipulation of the mounting bracket to re-align it with the converter shield bolt hole.



- Using a pair of needle nose pliers to squeeze the new clamps for the small shields at the flanges together will help make getting the bolts started much easier.
- When reinstalling the A/F Sensors, **NEVER** apply anti-sieze compound on the threads.
- **BEFORE** installing the shields onto the new EPF, confirm the new EPF fits into place on the cylinder head exhaust studs properly **WITHOUT** any prying or other manipulation.

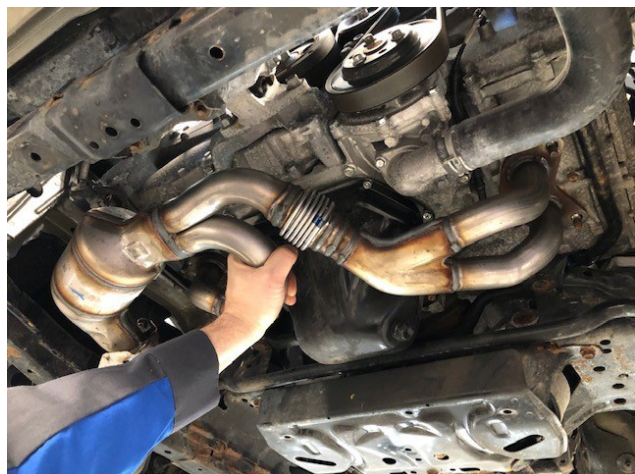

Continued...

- **TAKING YOUR TIME** when refitting the shields is **CRITICAL** for a successful repair. As the original shields are removed, take note (or photos) of how they are stacked together, especially in the middle of the EPF. Numbering the shields with a marker on both sides of a seam can help too. There will be witness marks left behind on some of them to provide insight to the order they go together and what should be on top or underneath of what. A routine will develop over time as more and more vehicles are repaired. As an example, in the photo below, there are four thicknesses of heat shield here being held together by these two bolts.

TIPS:

- Using a tapered center punch (or equivalent) as an alignment tool in the shield bolt holes will make installing the bolts easier.
- As the new hardware is installed, **leave the nuts loose** until all the shields are in place. This makes proper shield alignment easier.
- **VERY IMPORTANT:** After all the shields have been reinstalled, torque the nuts to 13 Nm (9.6 ft. lbs.) **EXCEPT for the two on the driver's side shield** shown in the photo below. This shield covers the bellows section of the EPF and if tightened, the dimension of the bellows may be changed enough to keep the EPF assembly from fitting back onto the exhaust studs properly.

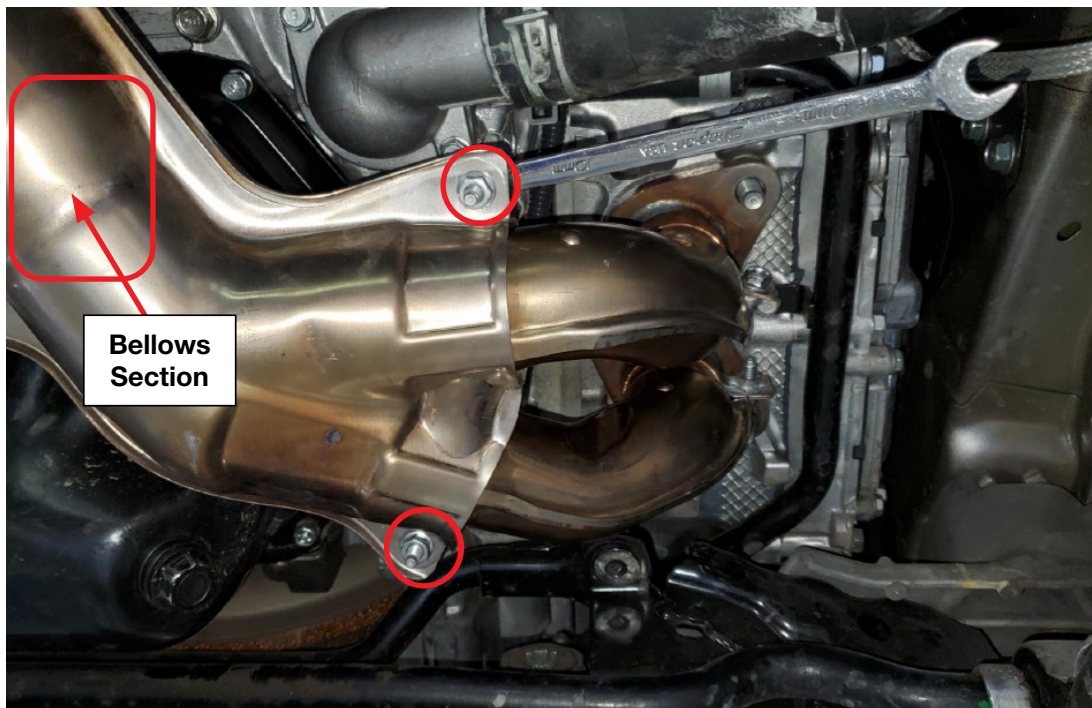
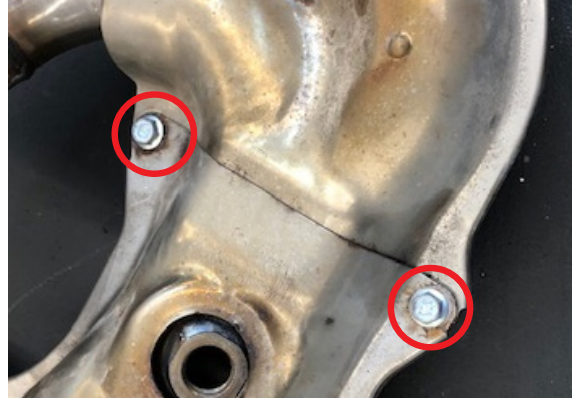

- Install the EPF assembly and torque the six cylinder head flange nuts to 30 Nm (22.1 ft. lbs.) **THEN tighten the last 2 heat shield bolts** shown above to 13 Nm (9.6 ft. lbs.).
- Re-connect the A/F sensor connectors.
- Reinstall the center exhaust pipe with the new gaskets supplied in the kit in reverse order of removal.

Continued...



Subaru of America, Inc
PO Box 9103
Camden, NJ 08101-9877
844-373-6614
www.subaru.com

**Subaru Service Program WUJ-95
Voluntary Emissions Recall
February 2020**

Dear Subaru Owner:

We would like to thank you for your selection of a Subaru vehicle. We take pride in our products and are committed to your continued satisfaction.

Subaru has become aware that certain 2015-2016 2.5L Legacy and Outback models may experience an exhaust noise and/or smell coming from cracks at the bellows of the front exhaust pipe which includes the catalytic converter. A leak occurring at the front exhaust pipe may result in deterioration of emission performance. As a result, your vehicle may fail to meet emission levels certified by the EPA and/or California ARB.

REASON FOR THIS VOLUNTARY EMISSIONS RECALL:

The front exhaust pipe assembly may have been installed under a stressful condition. As a result, the front exhaust pipe bellows may experience cracking during use possibly leading to exhaust gas leakage. Under this condition, a leak occurring at the front exhaust pipe may result in deterioration of emission performance.

You have received this notice because our records indicate that you currently own one of these vehicles.

REPAIR:

Your Subaru retailer (dealer) will replace the front exhaust pipe at no cost to you.

WHAT YOU SHOULD DO:

You should immediately contact your Subaru retailer (dealer) for an appointment to have this inspection and any necessary repair performed.

HOW LONG WILL THE REPAIR TAKE?

The time to perform the replacement is approximately 1 hour. However, your retailer can provide you with a better estimate of the overall time for this service visit, as it may be necessary to make your vehicle available for a longer period of time.

CALIFORNIA REGISTERED OWNERS:

The California Air Resources Board requires that emission-related campaigns be completed prior to California's vehicle registration renewal process; without this repair, you will not be able to register your vehicle during your next annual registration. Upon completion of this campaign, your California dealer will complete and provide you a "Proof of Correction Certificate." If required, present the certificate to the California Department of Motor Vehicles (the "DMV") when renewing your California registration as proof of campaign completion. If the DMV does not request the certificate, we recommend that you keep it for your records.

In addition, the State of California requires that every vehicle must pass an emission test (SMOG Check) every two years and before it is sold. Without the service we are providing at no charge, your vehicle may not pass this test.

Continued...

CHANGED YOUR ADDRESS OR SOLD YOUR SUBARU?

If you have moved or sold your vehicle, please update this information online at www.subaru.com, select 'Customer Support,' then select 'Address Update' or 'Ownership Update' from the drop-down menu.

IF YOU NEED FURTHER ASSISTANCE:

To locate the nearest Subaru retailer, you can access our website at www.subaru.com and select 'Find a Retailer.' If you need additional assistance, please contact us directly:

- By e-mail: Go to www.subaru.com, Customer Support and select "Contact Us"
- By telephone: 1-844-373-6614
Monday through Friday between 8:00 a.m. and 7:00 p.m. ET
- By U.S. Postal mail: Write us at: Subaru of America, Inc.
Attn: Customer-Retailer Services Department
P.O. Box 9103, Camden, NJ 08101-9877

Please contact us immediately if the Subaru retailer fails or is unable to make the necessary repairs free of charge.

Your continued satisfaction with your Subaru is important to us. Please understand that we have taken this action in the interest of your vehicle's proper operation. We sincerely apologize for any inconvenience this matter may cause and urge you to schedule an appointment as soon as possible to have this repair performed.

Sincerely,
Subaru of America, Inc.

Notice to Lessors: Under Federal law the lessor of a vehicle who receives this letter must provide a copy of it to the vehicle lessee(s) within 10 business days from receipt. The lessor must also keep a record of the lessee(s) to whom this letter is sent, the date sent, and the applicable vehicle identification number (VIN). (For the purposes of this section, a lessor means a person or entity that in the last twelve months prior to the date of this notification has been the owner, as referenced on the vehicle's title, of any five or more leased vehicles. A leased vehicle is a vehicle leased to another person for a term of at least four months.)

A subsidiary of SUBARU CORPORATION