

- ATTENTION:**
- GENERAL MANAGER
 - PARTS MANAGER
 - CLAIMS PERSONNEL
 - SERVICE MANAGER

IMPORTANT - All Service Personnel Should Read and Initial in the boxes provided, right.

| | | |
|--|--|--|
| | | |
| | | |

© 2020 Subaru of America, Inc. All rights reserved.



QUALITY DRIVEN® SERVICE

SERVICE PROGRAM BULLETIN

APPLICABILITY: 2014-2016 MY Forester

NUMBER: WUT-05R

SUBJECT: Forester Rear Coil Springs

DATE: 01/20/20

REVISED: 01/22/20

INTRODUCTION:

In the interest of customer satisfaction, Subaru of America, Inc. (Subaru) is initiating a service program to replace the rear coil springs on certain 2014-2016 model year Forester vehicles. Over time, if the rear coil spring outer coating is damaged by stones and other road debris, the spring material may develop pitting from corrosion and a small section of the spring could break away. When this condition is present, owners of affected vehicles may notice (i) pieces of metal (spring) on the ground near where the vehicle is parked or (ii) one corner of the vehicle sitting lower.

AFFECTED VEHICLES:

There are 498,995 vehicles in the U.S. affected by this campaign.

| Model Year | Carline | Production Range | VIN Range |
|------------|----------|---------------------------------|---------------------|
| 2014-2016 | Forester | March 25, 2013 – April 28, 2016 | EG428969 - GH569086 |

Coverage for all affected vehicles must be confirmed by using the Vehicle Coverage Inquiry function on subarunet.com. This information is now available.

DESCRIPTION OF THE REPAIR:

Subaru retailers will replace both rear coil springs with new springs that have improved resistance to corrosion.

RETAILER RESPONSIBILITY:

Retailers are to promptly perform this repair on any affected vehicles that may be in their inventory. Additionally, whenever a vehicle subject to this service program is taken into inventory or in for service, necessary steps should be taken to ensure the repair has been made before selling or releasing the vehicle.

| | |
|--|--|
| <p>CAUTION: VEHICLE SERVICING PERFORMED BY UNTRAINED PERSONS COULD RESULT IN SERIOUS INJURY TO THOSE PERSONS OR TO OTHERS.</p> <p>Subaru Service Bulletins are intended for use by professional technicians ONLY. They are written to inform those technicians of conditions that may occur in some vehicles, or to provide information that could assist in the proper servicing of the vehicle. Properly trained technicians have the equipment, tools, safety instructions, and know-how to do the job correctly and safely. If a condition is described, DO NOT assume that this Service Bulletin applies to your vehicle, or that your vehicle will have that condition.</p> | <p style="text-align: center;">Subaru of America, Inc. is ISO 14001 Compliant</p> <p>ISO 14001 is the international standard for excellence in Environmental Management Systems. Please recycle or dispose of automotive products in a manner that is friendly to our environment and in accordance with all local, state and federal laws and regulations.</p> |
|--|--|

Continued...

Any vehicles listed in a service program that are in the retailer's stock must be:

- Immediately identified.
- Tagged or otherwise marked to prevent their delivery or use prior to inspection and/or repair.
- Updated in accordance with the repair procedures outlined in this Service Program Bulletin.

OWNER NOTIFICATION:

Subaru expects to begin notifying affected vehicle owners by first class mail in January 2020. Retailers will be advised when owner notification begins.

RETAILER AFFECTED VIN LISTS:

Each Subaru retailer will receive an affected VIN list from their Zone office when owner notification begins. Vehicles will be assigned to retailers in the affected VIN list as follows: Please note that this logic has recently changed:

1. If there is a preferred retailer on file, the VIN will be assigned to the preferred retailer.
2. If there is no preferred retailer on file:
 - a. Original vehicle owners are assigned to the original selling retailer if their current DMV registration address is within a 50-mile radius of that retailer.
 - b. If the original selling retailer is inactive, the VIN is assigned to the nearest active retailer.
 - c. If the owner is not the original owner, the VIN is assigned to the nearest active retailer.

PARTS INFORMATION:

| Part Name | Kit Part Number | Application | Break-Down of Kit Contents | | Qty. |
|-------------------|-----------------|-----------------------|----------------------------|-------------------|------|
| COIL SPRING R KIT | X2038SG000 | 2.5L NA Engine w/ MT | 20380SG001 | COIL SPING REAR | 2 |
| | | | 902350029 | SELF LOCK NUT M10 | 6 |
| | | | 902380019 | NUT FLG M10 | 2 |
| | | | 902350022 | SELF LOCK NUT M12 | 4 |
| | | | 902330006 | SELF LOCK NUT M14 | 2 |
| COIL SPRING R KIT | X2038SG010 | 2.5L NA Engine w/ CVT | 20380SG011 | COIL SPING REAR | 2 |
| | | | 902350029 | SELF LOCK NUT M10 | 6 |
| | | | 902380019 | MUT FKG M10 | 2 |
| | | | 902350022 | SELF LOCK NUT M12 | 4 |
| | | | 902330006 | SELF LOCK NUT M14 | 2 |
| COIL SPRING R KIT | X2038SG020 | 2.0L DIT Engine | 20380SG021 | COIL SPING REAR | 2 |
| | | | 902350029 | SELF LOCK NUT M10 | 6 |
| | | | 902380019 | MUT FKG M10 | 2 |
| | | | 902350022 | SELF LOCK NUT M12 | 4 |
| | | | 902330006 | SELF LOCK NUT M14 | 2 |

NOTE: The paint markings on the replacement coil springs will likely differ from the original springs.

Continued...

SERVICE PROCEDURE:

OVERVIEW: This Service Procedure involves a visual inspection of both rear coil springs and replacement of one or both depending on the outcome.

NOTE: In the RARE case where inspection shows only 1 spring requires replacement, order the applicable kit and use the necessary spring and hardware. **DO NOT** order individual parts when only a 1-side repair is required.

Step 1) INSPECTION: Inspect the coil springs on both rear shock absorber assemblies to determine if either has a gray colored protective tube installed on the bottom coils as shown below.

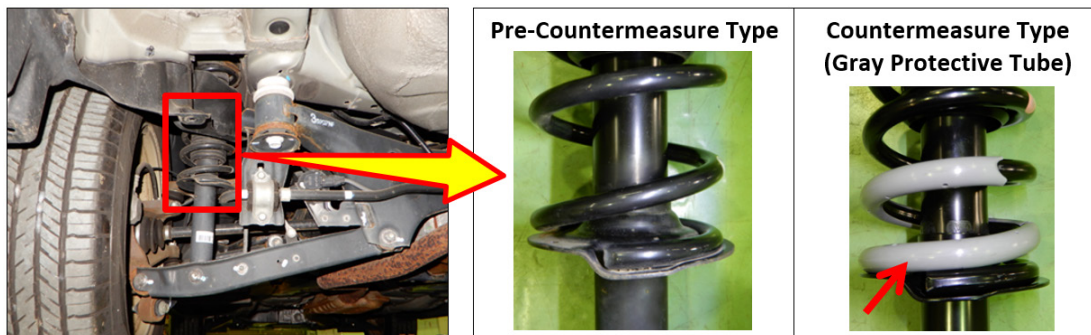

- If either (or both) of the coil springs are the Pre-Countermeasure Type (NO gray protective tube on the bottom coils), proceed to **Step 2** and replace ONLY the affected spring(s).
- If **BOTH** coil springs are the Countermeasure Type (gray protective tube installed on the bottom coils), the procedure is complete. Proceed to the Claim Reimbursement and Entry Procedures section and process a claim for Inspection Only.

IMPORTANT:

This Service Procedure outlines removal of the rear shock absorber assemblies **without** disturbing the rear wheel suspension alignment. The repair parts kit contains suspension component nuts to replace those which are **one-time use**. In most cases, when following this procedure, 2 of 902350022 (M12 12mm self-locking nuts) and 2 of 902330006 (M14 self-locking nuts) will not be used. These nuts are for the bolts connecting the lateral link to the rear axle housing and are not removed when performing this procedure.

Step 2) With the vehicle raised and rear wheel(s) removed, remove the nuts and bolts for the rear stabilizer bar links (1) and lower shock absorber(s) (2) from the lateral link(s). Discard these nuts as they are **one-time use**. Remove the stabilizer bar end links from the lateral links as shown below.

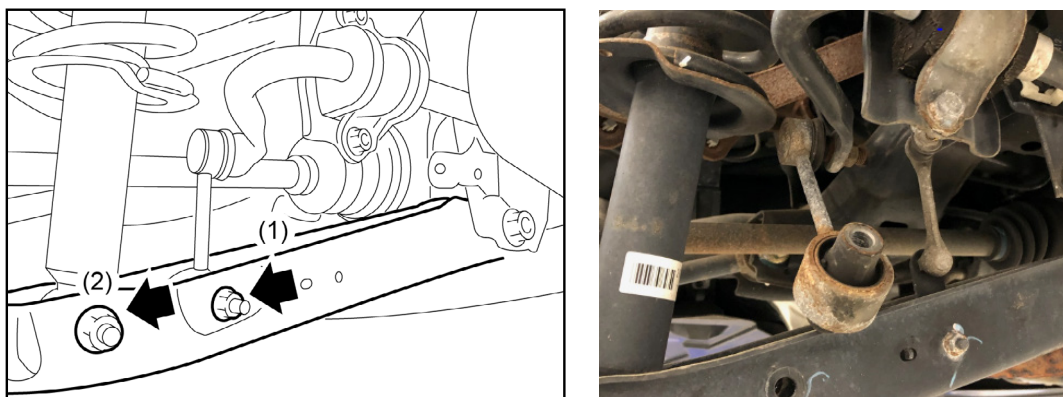

Continued...

Step 3) Remove the mat, trunk cover and both foam spacers from the cargo area.

Step 4) Using a plastic trim tool, **CAREFULLY** remove the access covers from the trim panels on each side. This provides access to the top shock mount retaining nuts.

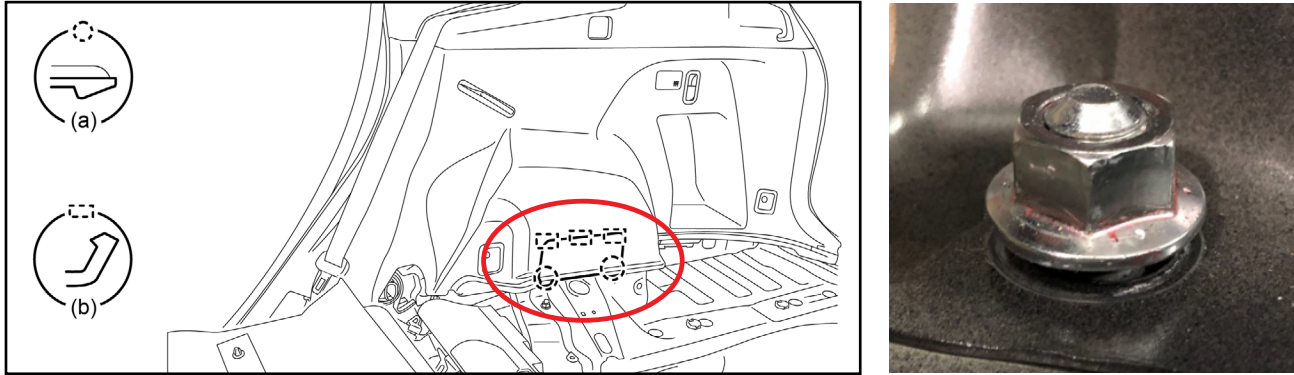

Step 5) Remove both front (closest to the rear seat backrest) retaining nuts and discard them as they are **one-time use** items. Loosen (but do not remove) the rear nuts. Loosen them enough so the top of the nut aligns with the taper at the start of the threads as shown above. This will allow movement of the shock absorber assemblies making it easier to remove from the lateral links and keeps them from dropping out of the vehicle after removal.

Step 6) IMPORTANT: CAREFULLY remove the brake hose retaining bracket bolts from each side.

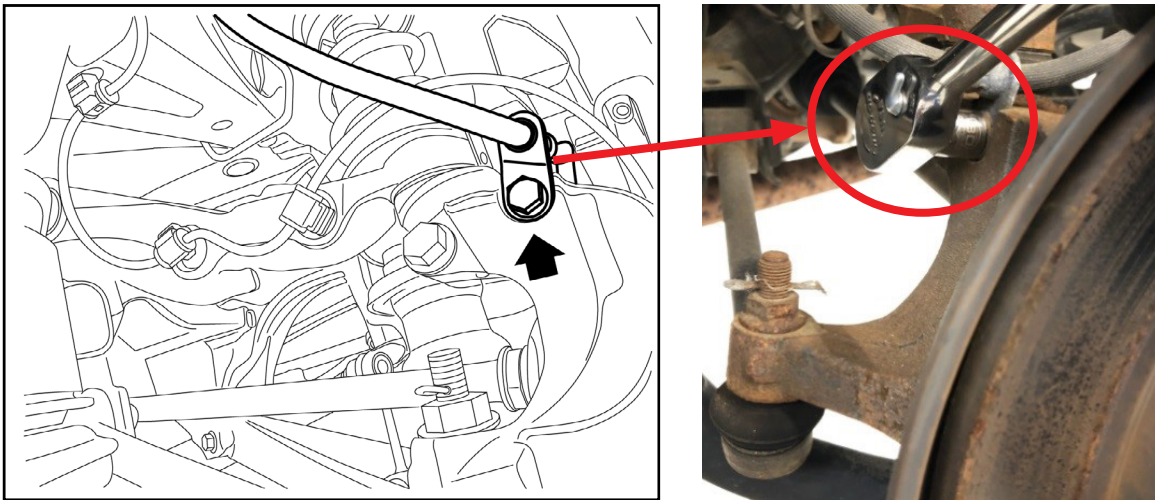

Step 7) CAREFULLY insert a long pry bar (or a suitable equivalent) into the suspension above the lateral link as shown in photos 1 and 2 below. The pry bar is used to push down on the rear lateral link enough to free the shock absorber assembly. **IMPORTANT:** Use a shop cloth over the end of the pry bar to avoid damaging the finish of the suspension components and exposing any bare metal places for rust to develop. A helper is **STRONGLY** recommended for this step. While the helper presses down on the pry bar **ONLY AS FAR AS NECESSARY**, disengage the shock absorber from the lateral link toward the rear of the vehicle as shown in photo 3 below.

Continued...

TIP: A smaller pry bar may come in handy to pry the bottom of the shock absorber assembly out of the lateral link.

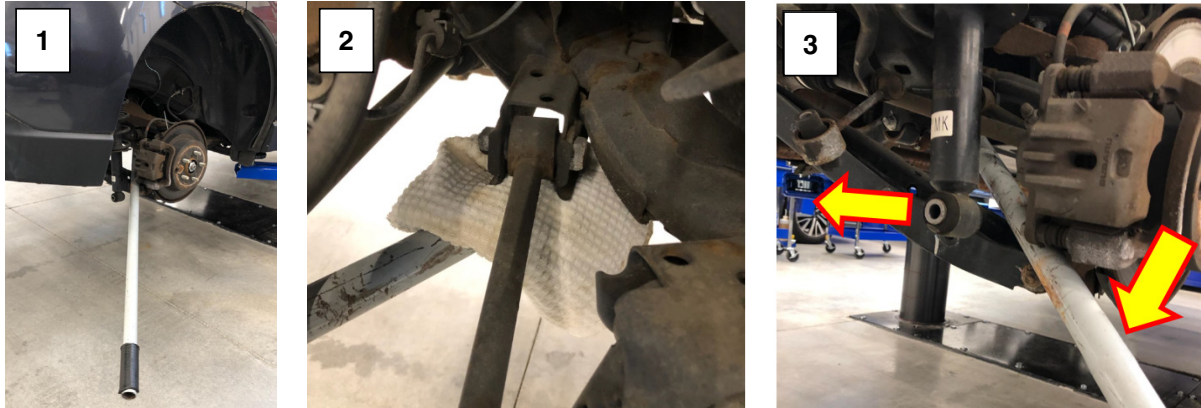

Step 8) Remove and discard the other top retaining nut loosened in **Step 5** and remove the affected shock absorber assembly from the vehicle.

Step 9)

CAUTION:

- It is **STRONGLY** recommended to **NOT** use an impact wrench (gun) when removing / installing the self-locking nut securing the shock absorber (strut) to the upper strut mount. The repeated shock generated by the impact wrench can damage internal components of the shock absorber.
- Reconfirm the part number of the Coil Spring Kit before reassembly to prevent installation of any incorrect parts.

CAREFULLY disassemble the shock absorber assembly following the procedure and all precautions outlined in the applicable Service Manual. Inspect all components closely and replace as necessary before reassembly with the new coil spring.

TIP: When reassembling the rear shock mount, confirm the direction and angle relations very carefully as described in the applicable Service Manual and illustrations shown here.

A - Left (Driver's) Side

B - Right Side

- (a) Front of Vehicle
- (b) Toward OUTSIDE of Vehicle
- (c) 10 degrees +/- 5 degrees
- (d) End of Coil Spring
- (e) Identification Marking

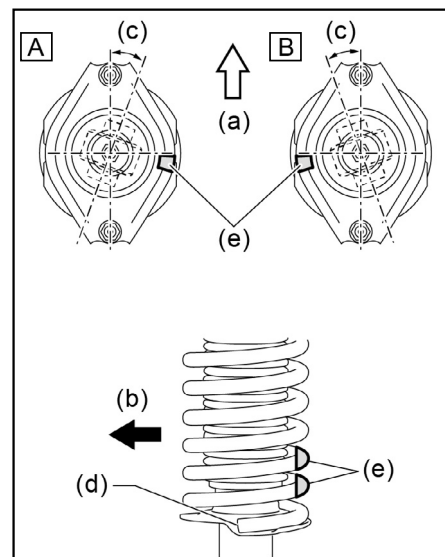

NOTE: The end of the coil spring with the gray protective tube (d) must be at installed toward the base of the shock absorber assembly.

Continued...

Step 10) Install the reassembled shock absorber assembly back up into position. Start BOTH new top retaining nuts onto the mounting studs FRONT NUT FIRST at least a few full threads to hold the assembly in position while the shock absorber assembly is reinstalled into the lateral link.

IMPORTANT REMINDER: When reassembling the rear suspension, the new self-locking nuts provided in the kit **MUST** be used as they are all **one-time use** items. Complete the reassembly in reverse order of removal.

CLAIM REIMBURSEMENT AND ENTRY PROCEDURES:

Credit to perform this recall will be based on properly completed repair order information. Retailers may submit claims through Subarunet.com.

| Labor Description | Labor Operation # | Labor Time | Fail Code | Claim Type |
|---------------------------------------|-------------------|------------|-----------|------------|
| Rear Coil Springs INSPECTION ONLY | A161-268 | 0.2 | WUT-05 | RC |
| Replace Rear Coil Spring- ONE SIDE* | A161-263 | 0.9 | | |
| Replace Rear Coil Springs- BOTH SIDES | A161-264 | 1.2 | | |

***NOTE:** When only one coil spring is replaced, claim comments must include a note indicating the side that was repaired.

SERVICE PROGRAM IDENTIFICATION LABEL:

Type or print the necessary information on a Campaign Identification Label. The completed label should be attached to the vehicle’s upper radiator support. Additional labels are available through normal parts ordering channels. The part number is **MSA6P1302**, which comes as one sheet of 20 labels.

| Part Number | Applicability | Description | Order Quantity |
|-------------|---------------|--|----------------|
| MSA6P1302 | All Models | Campaign Completion Labels (contains one sheet of 20 labels) | 1 |

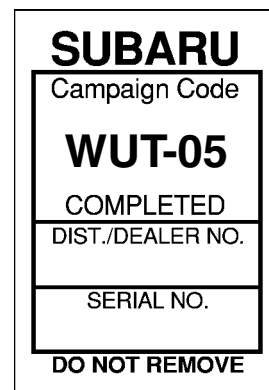

IMPORTANT REMINDERS:

- SOA strongly discourages the printing and/or local storage of service information as previously released information and electronic publications may be updated at any time.
- Always check for any open recalls or campaigns anytime a vehicle is in for servicing.
- Always refer to STIS for the latest service information before performing any repairs.

Continued...