

Special Coverage Adjustment

16188 Brake Lamp Malfunction



Reference Number: N162075260

Release Date: March 2017
Revision: 00

Make	Model	Model Year		RPO	Description
		From	To		
Chevrolet	Malibu	2004	2012		
	Malibu Maxx	2004	2007		
Pontiac	G6	2005	2010		
Saturn	AURA	2007	2009		

Involved vehicles are identified on the Applicable Warranties section in GM Global Warranty Management system. This site should always be checked to confirm vehicle involvement prior to beginning any required inspections and/or repairs.

Condition	Some 2004-2012 model year Chevrolet Malibu, 2004-2007 model year Chevrolet Malibu Maxx, 2005-2010 model year Pontiac G6, and 2007-2009 model year Saturn AURA vehicles may have a condition where increased resistance in the body control module (BCM) connection system can result in voltage fluctuations or intermittency in the brake apply sensor (BAS) circuit that can cause brake lamp malfunction. Specifically, the brake lamps may either illuminate without the brake pedal applied, or turn off when the pedal is applied.
Special Coverage Adjustment	<p>This special coverage covers the condition described above for a period of 15 years or 150,000 miles (240,000 km), whichever occurs first, from the date the vehicle was originally placed in service, regardless of ownership.</p> <p>For vehicles covered by Vehicle Service Contracts, all eligible claims with repair orders on or after March 3, 2017, are covered by this special coverage and must be submitted using the labor operation codes provided with this bulletin. Claims with repair orders prior to March 3, 2017, must be submitted to the Service Contract provider.</p> <p>Vehicle owners or lessees who paid for repairs referenced in this Special Coverage ("Customers") are eligible for reimbursement of their reasonable and customary expenses in accordance with the procedures specified below. The conditional right to reimbursement is provided by GM solely in the interest of customer satisfaction and is personal to Customers. <i>Customers may not assign and GM does not consent to any assignment of any Customer's right to submit reimbursement claims, or to receive reimbursement, or any other rights granted by this Special Coverage to any third party, including but not limited to service contract providers, and this Special Coverage is not intended to and does not confer any third party beneficiary, subrogation or contribution rights, or any other rights to reimbursement, against GM, whether in law, equity or otherwise, on any third parties.</i></p>
Correction	Dealers are to attach the wiring harness to the BCM with a spacer, apply dielectric lubricant to the BCM X2 (C2) connector and the BAS harness connector, and relearn the brake pedal home position. The repairs will be made at no charge to the customer.

Special Coverage Adjustment

16188 Brake Lamp Malfunction



Parts

Quantity	Part Name	Part No.
1	Retainer-Brk Ped (Short Tie Strap - Pkg of 10)	15188763
2	Strap-EGR Tube (Long Tie Strap - Pkg of 10)	11509086
1 (Submit as Net Item)	14 Inch Tie Strap	Obtain Locally
1	Clip-Wrg Harn (Tie-Down Mount)	13596990
1 (If Required)	Retainer-Acsry Wrg Harn (Rubber Spacer)	13596991
As Required (Submit as Net Item)	Promoter, Plastic Adhesion (4 OZ)	12378462 (US) 10953554 (Canada)
As Required (Submit as Net Item)	Lubricant, Dielectric (2 OZ)	12377900 (US) 10953529 (Canada)
As Required (Submit as Net Item)	Woven Polyester Electrical Tape (PET) – Part Number 1089482	Obtain from Kent Automotive*

* To obtain the PET tape, contact Kent Automotive at 1-888-937-5368 (USA), 1-800-563-1717 (Canada), or www.kent-automotive.com to request the special order part number 1089482. Dealers that do not have a Kent Automotive account or representative, must advise the Customer Service Representative that part 1089482 is being used for GM Bulletin 16188 to obtain special bulletin pricing. **Do not order from GMCCA.**

Warranty Information

Labor Operation	Description	Labor Time	Trans. Type	Net Item
9900449	Inspect Only – No Further Action Required	0.1-0.3	ZREG	N/A
9900450	BCM and BPPS Harness and Connector Repair Add: Diagnostic Time	0.5 0.1-0.3	ZREG	*
9900451	Customer Reimbursement Approved - For USA and Canada dealers only - For Export dealers only	N/A 0.2	ZREG	**
9900452	Customer Reimbursement Denied – For USA dealers only	N/A	ZREG	***

* The amount identified in “Net Item” should represent the actual sum total of the current GMCCA dealer net price for plastic Adhesion Promoter, Dielectric Lubricant and Woven Polyester Electrical Tape needed to perform the required repairs, not to exceed \$1.12 USD, \$1.20 CAD, plus applicable Mark-Up or Landed Cost (for Export).

** For USA and Canada: Submit the dollar amount reimbursed to the Customer in Net/Reimbursement. Submit \$20.00 administrative allowance in Net/Admin Allowance.

For Export: Submit the dollar amount reimbursed to the Customer in Net/Reimbursement.

*** Submit \$10.00 administrative allowance in Net/Admin Allowance.

Special Coverage Adjustment

16188 Brake Lamp Malfunction



Service Procedure

Note: This special coverage ONLY covers the circuits between the brake pedal position sensor (BPPS) and the body control module (BCM). This special coverage does not cover normal maintenance and long term wear beyond normal useful life of components such as, but not limited to, stop lamp bulbs or the circuits between the BCM and the stop lamps.

1. Verify proper operation of the stop lamps. Refer to the appropriate diagnostic information in SI.
 - If the stop lamps are operating as designed, no further action is required. Inform the customer that any additional diagnosis and repairs are not covered under this special coverage.
 - If the stop lamps are illuminated without depressing the brake pedal, perform the service procedure as outlined in this special coverage bulletin.
 - If the stop lamps do NOT illuminate while depressing the brake pedal, determine if the condition is caused by the wiring and/or terminals between BPPS and the BCM.
 - If the condition is NOT caused by the wiring and/or terminals between the BPPS and the BCM, inform the customer that any additional diagnosis and repairs are not covered under this special coverage. Refer to the appropriate diagnostic information in SI.
 - If the condition is caused by the wiring and/or terminals between the BPPS and the BCM, perform the service procedure as outlined in this special coverage bulletin.

Service Procedure Checklist

The following checklist is ONLY intended to supplement special coverage bulletin 16188. It is NOT designed to replace the service information. This checklist assumes that you have read, understand, and will closely follow all of the steps in the recall bulletin to ensure a proper repair. Please use this as a guide while performing the special coverage bulletin to ensure ALL of the required repairs are performed.

- Perform a terminal drag test on the brake pedal position sensor (BPPS) cavity terminals.
- Apply dielectric lubricant to BPPS cavity terminals.
- Apply dielectric lubricant to BPPS connector.
- Cut off existing gray tie strap to obtain more wiring harness slack for BCM connection.
- Remove tie strap from BCM connector X2 (C2) harness.
- Install NEW tie straps to BCM connector X2 (C2) harness.
- Perform a terminal drag test on BCM connector X2 (C2) terminals 18, 31, and 59.
- Apply dielectric lubricant to BCM terminals in cavity X2 (C2).
- Apply dielectric lubricant to connector face of BCM connector X2 (C2).
- Apply adhesion promoter, install tie-down mount, tie strap and rubber spacer to upper corner of BCM (Pontiac G6, Saturn AURA, and 2008-2012 Chevrolet Malibu).
- Clean the surface of the IP Mag Beam using an alcohol wipe, apply adhesion promoter, install tie-down mount and tie straps to IP Mag Beam (rubber spacer is not needed for the following models) (2004-2007 Chevrolet Malibu Sedan and Maxx, and 2008 Chevrolet Malibu Classic).
- Perform the brake pedal position sensor calibration.

Special Coverage Adjustment

16188 Brake Lamp Malfunction



Dielectric Lubricant Application Procedure (All Models)

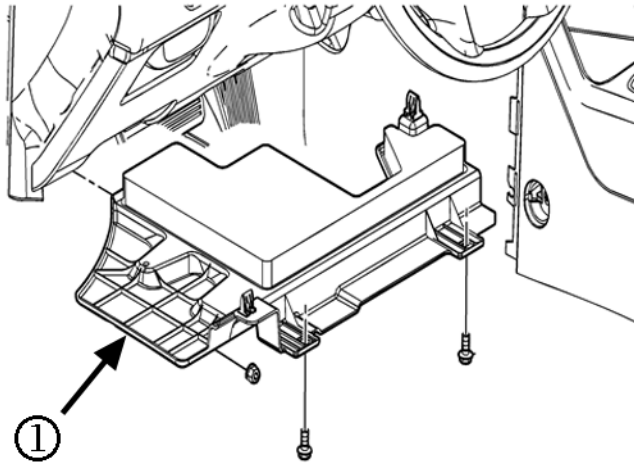

3963176

1. Remove the driver side instrument panel insulator panel (1). Refer to *Instrument Panel Insulator Replacement - Left Side* in SI.

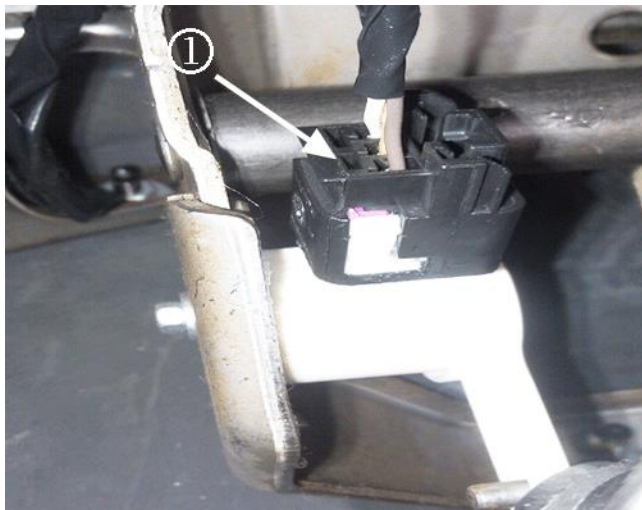

3963182

2. Disconnect the Brake Pedal Position Sensor (BPPS) connector (1).

Caution: ONLY use test leads from J-35616-F, GM Terminal Test Probe Kit, to front probe terminals. Do not insert test equipment probes (DMM etc.) into any connector or fuse block terminal. Do not use paper clips or other substitutes to probe terminals. The diameter of an incorrect test probe will deform most female terminals. A deformed terminal will result in a poor connection and system failure.

When using the J-35616-F GM Terminal Test Probe Kit, ensure the terminal diagnostic test probe is the correct size for the connector terminal. Do not visually choose the terminal diagnostic test probe because some connector terminal cavities may appear larger than the actual terminal in the cavity. Refer to the connector end view in SI or the label inside of the J-35616-F GM Terminal Test Probe Kit cover to ensure the correct terminal diagnostic test probe is selected.

3. Using terminal adapter J-35616-2A (GY), perform a terminal drag test on the BPPS connector terminals. Verify that the retention force is significantly different between a known good terminal and the suspect terminal. Replace any female terminal(s) in question.

Special Coverage Adjustment 16188 Brake Lamp Malfunction



4694672

- Using the applicator stick, apply a smaller 5 mm x 5 mm x 5 mm dab of dielectric lubricant completely across all of the terminal pins in the BPPS connector cavity.
- Use a one-inch nylon bristle brush to spread the lubricant evenly onto all terminal pins.

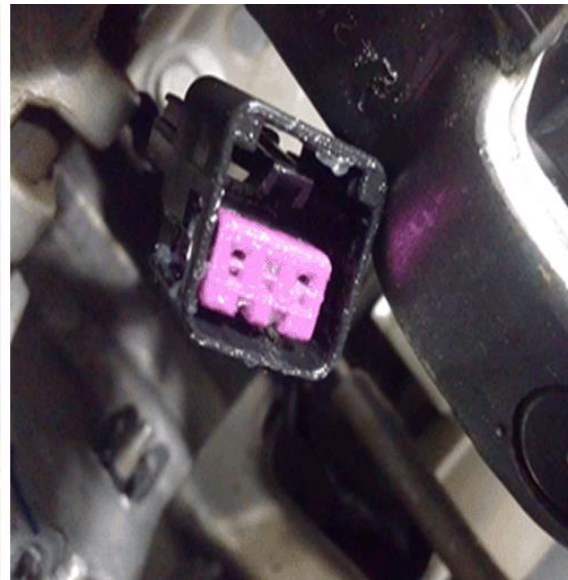

4694680

- Apply a 5 mm x 5 mm x 5 mm dab of dielectric lubricant completely across the connector face of the BPPS connector.
- Use a one-inch nylon bristle brush to spread the lubricant evenly into all terminal holes.
- Reconnect the connector back on the BPPS.

Special Coverage Adjustment 16188 Brake Lamp Malfunction

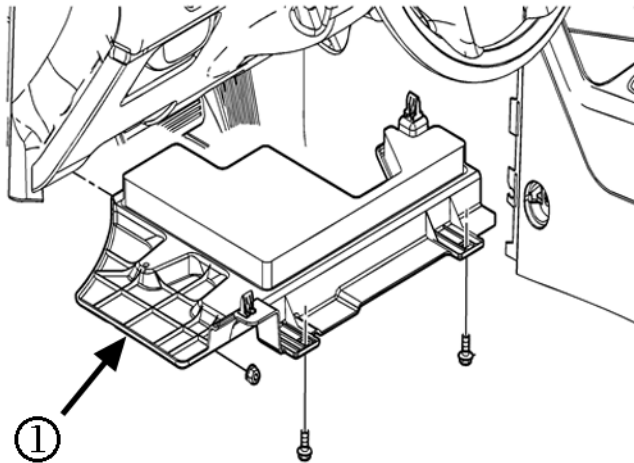

3963176

9. Reinstall the driver side instrument panel insulator panel (1). Refer to *Instrument Panel Insulator Replacement - Left Side* in SI.

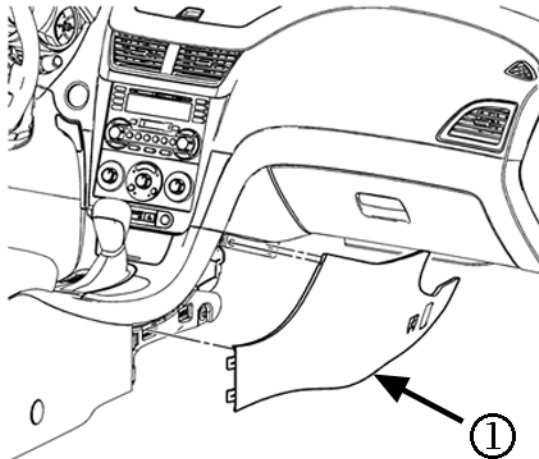

3963121

10. Remove the right side front floor console side trim panel (1) to access the Body Control Module (BCM).

Special Coverage Adjustment 16188 Brake Lamp Malfunction



3684285

11. Unlatch the X2 (C2) connector (1) and disconnect the connector from the BCM.

Caution: ONLY use test leads from J-35616-F, GM Terminal Test Probe Kit, to front probe terminals. Do not insert test equipment probes (DMM etc.) into any connector or fuse block terminal. Do not use paper clips or other substitutes to probe terminals. The diameter of an incorrect test probe will deform most female terminals. A deformed terminal will result in a poor connection and system failure.

When using the J-35616-F GM Terminal Test Probe Kit, ensure the terminal diagnostic test probe is the correct size for the connector terminal. Do not visually choose the terminal diagnostic test probe because some connector terminal cavities may appear larger than the actual terminal in the cavity. Refer to the connector end view in SI or the label inside of the J-35616-F GM Terminal Test Probe Kit cover to ensure the correct terminal diagnostic test probe is selected.

12. Using terminal adapter J-35616-64B (L-BU), perform a terminal drag test on BCM X2 (C2) connector terminals 18, 31, and 59. Verify that the retention force is significantly different between a known good terminal and the suspect terminal. Replace any female terminal(s) in question.
13. Remove the blue latch cover from the connector.

Special Coverage Adjustment 16188 Brake Lamp Malfunction



Caution: Be careful not to damage the harness when cutting the tie strap push pin.

14. Remove the tie strap push pin (1) from the instrument panel and cut it off of the BCM harness using side cutters. This will allow more wiring harness slack.

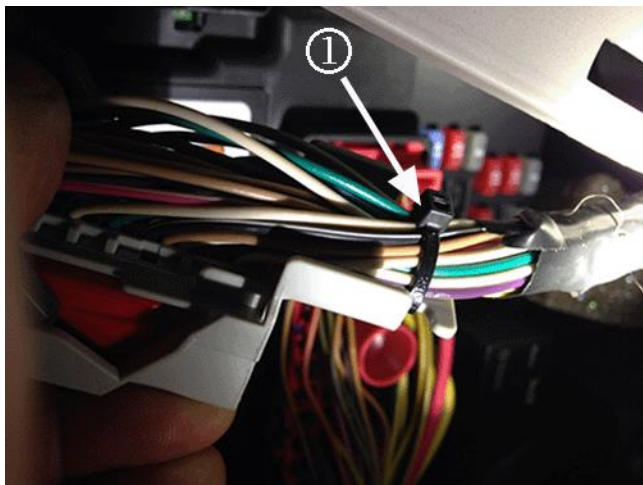

15. To allow for installation of the tie strap added in the next step, remove the existing tie strap (1) from the end of the connector.

Special Coverage Adjustment 16188 Brake Lamp Malfunction

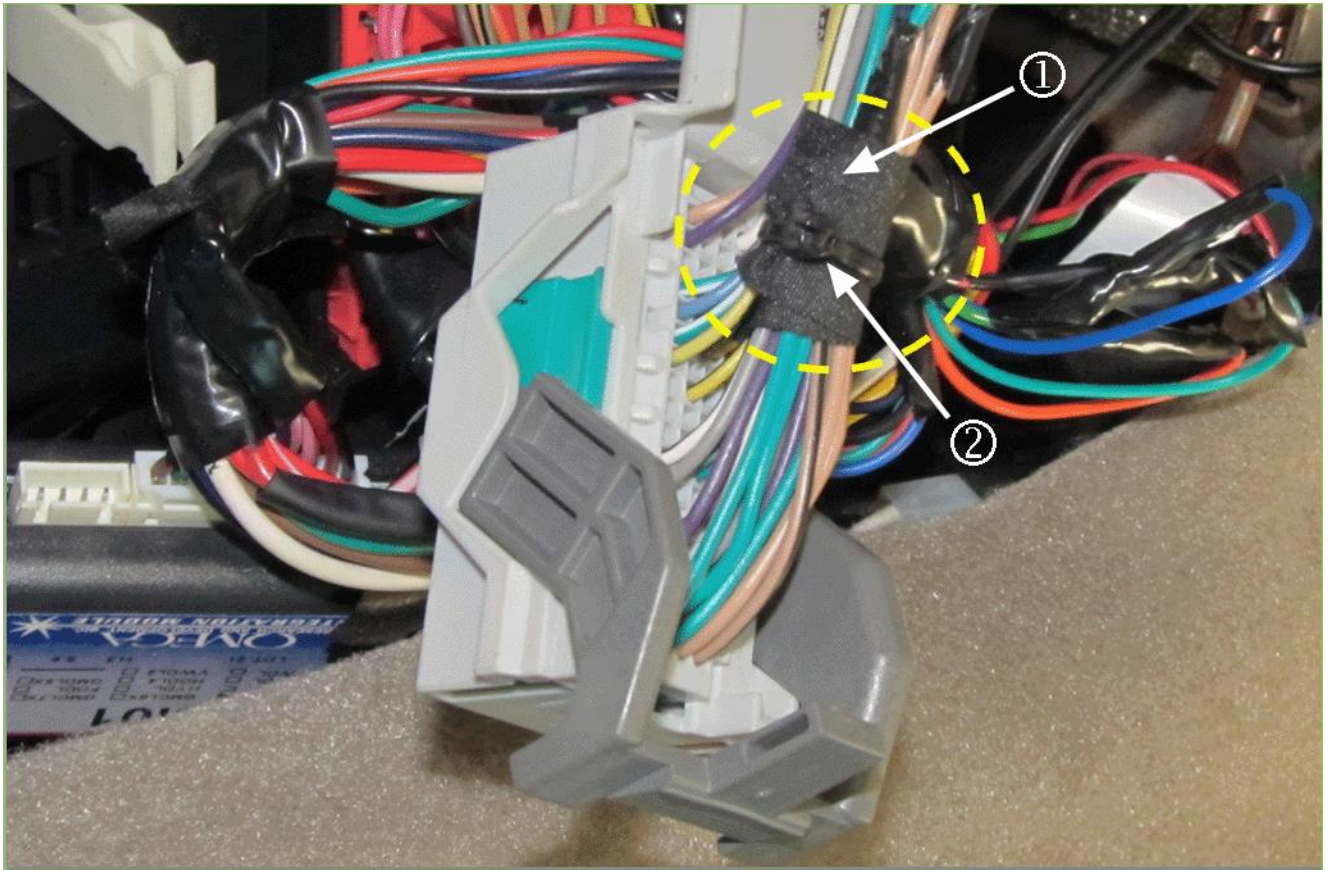

3963132

Important: ONLY use non-abrasion Woven Polyester Electrical Tape (PET). Do NOT use vinyl electrical tape.

Note: You will not be able to tie strap the complete bundle of wiring; exclude approximately the first three rows of the wiring bundle.

16. Install Kent Automotive non-abrasion Woven Polyester Electrical Tape (PET) (1) and a new (short) tie strap (2) to the wiring within the BCM connector bundle.

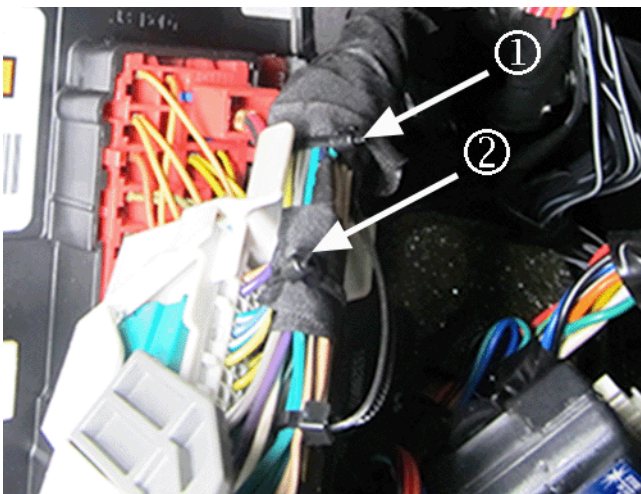

4234876

17. Once the additional short tie strap (2) is added, apply PET and install a new long tie strap (1) at the location where original tie strap was removed.

Special Coverage Adjustment 16188 Brake Lamp Malfunction



4694685

18. Using the applicator stick, apply a 10 mm x 10 mm x 10 mm dab of dielectric lubricant completely across all of the terminal pins in the BCM connector cavity.

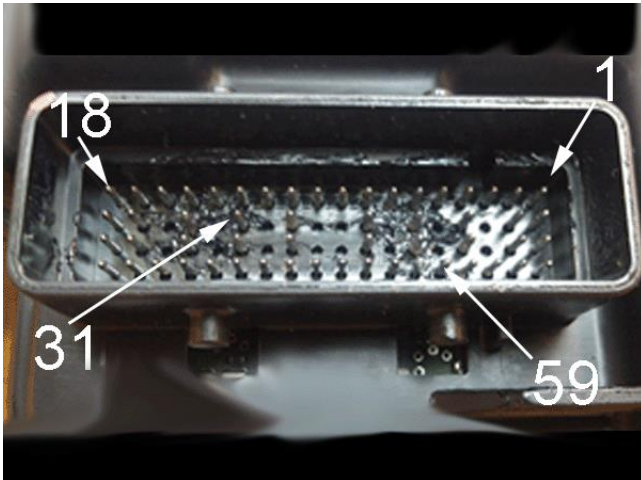

3763821

Note: Terminal 1 is called out for reference ONLY.

19. Apply a 10 mm dab of dielectric lubricant (clear gel) completely across all of the terminal pins for connector X2 (C2) in the BCM. Verify that terminal pins 18, 31, & 59 are thoroughly coated.

Special Coverage Adjustment 16188 Brake Lamp Malfunction

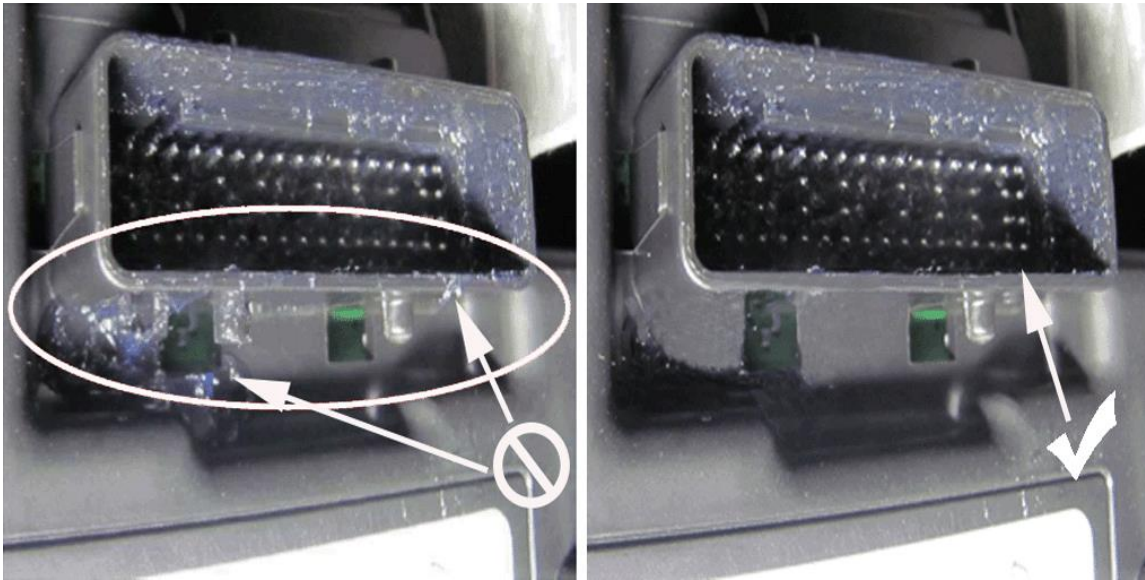

4694676

Note: Do NOT apply dielectric lubricant outside of the cavity for connector X2 (C2) in the BCM

20. Use a one-inch nylon bristle brush to spread the lubricant evenly onto all terminal pins.
21. Again using the applicator stick, apply a 10 mm dab of dielectric lubricant completely across the X2 (C2) connector face of the BCM connector.

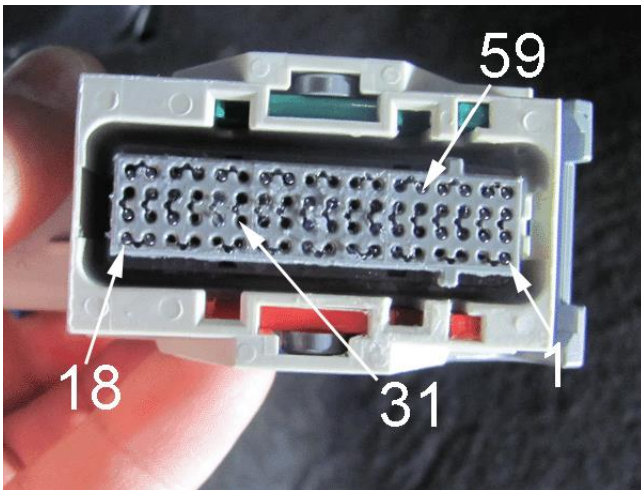

3763832

22. Use a one-inch nylon bristle brush to spread the lubricant evenly into all terminal holes. Verify that terminal locations 18, 31, & 59 are thoroughly coated.
23. Reinstall the blue latch cover to connector X2 (C2), reconnect the connector back on the BCM and re-latch.
24. Wipe away any excess lubricant.
25. Apply pressure to connector X2 (C2) to verify it is fully seated.
26. Depending on vehicle model, follow the appropriate *BCM Harness Tie Strap Installation Procedure* below.

Special Coverage Adjustment

16188 Brake Lamp Malfunction



BCM Harness Tie Strap Installation Procedure

(Pontiac G6, Saturn AURA, and 2008-2012 Chevrolet Malibu)

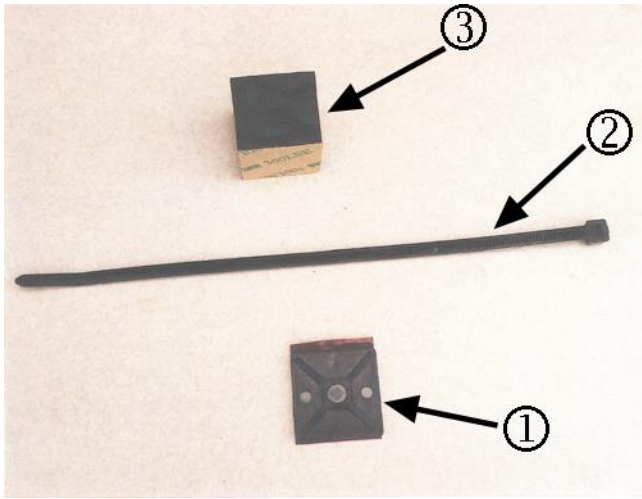

3963139

Note: The new tie-down mount (1), tie strap (2) and rubber spacer (3) will be added to secure the harness at the upper forward corner of the BCM.

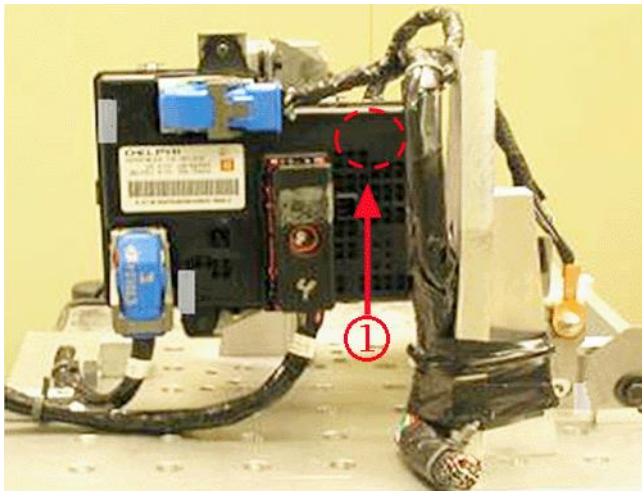

3963147

1. Install the new tie down clip to the outboard, upper forward corner (1) of the BCM housing.
 - 1.1. Carefully apply GM Plastic Adhesion Promoter the upper forward corner of the BCM.

Special Coverage Adjustment 16188 Brake Lamp Malfunction

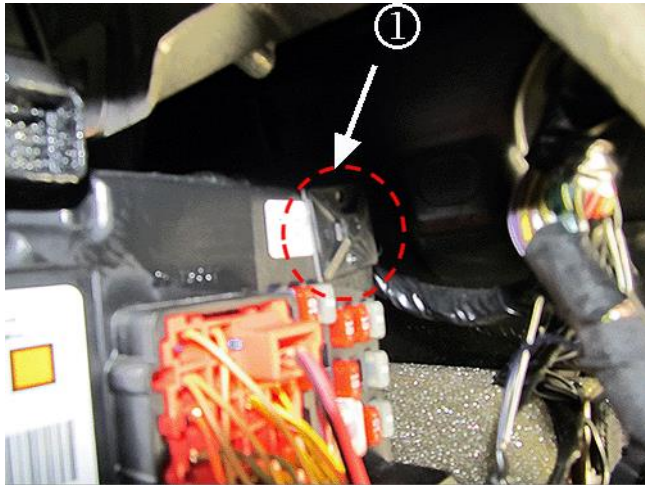

3963151

Note: Ensure the orientation of the clip is such that the slot is in the vertical direction to accept the tie strap.

1.2. Peel the backing from the adhesive on the tie down mount (1) and install the mount to the BCM. Let the promoter and adhesive set up while applying the dielectric lubricant and tape.



4694689

2. Apply Kent Automotive non-abrasion PET to the BCM harness, covering the tie strap just outside the X2 (C2) connector, and extending to 25 mm (1 in) past the forward corner of the BCM as shown.

Note: Be sure to carefully cinch the tie strap completely so the harness is secured.

3. Stack the new rubber spacer (2) on top of the tie-down mount (3) (installed previously), position the BCM harness across the spacer, install the long tie strap (4) through the slot on the mount and carefully cinch the tie strap.

Special Coverage Adjustment 16188 Brake Lamp Malfunction

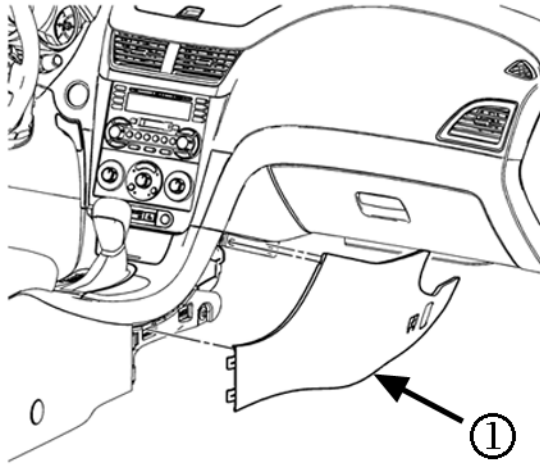

3963121

4. Reinstall the right side front floor console side trim panel (1).
5. Perform the brake pedal position sensor calibration. Refer to *Brake Pedal Position Sensor Calibration* in SI.
6. Verify proper operation of the brake lights.

Special Coverage Adjustment

16188 Brake Lamp Malfunction



BCM Harness Tie Strap Installation Procedure

(2004-2007 Chevrolet Malibu Sedan and Maxx, and 2008 Chevrolet Malibu Classic)

1. Clean the surface of the IP Mag Beam using an alcohol wipe.
2. Carefully apply GM Plastic Adhesion Promoter to the IP Mag Beam.

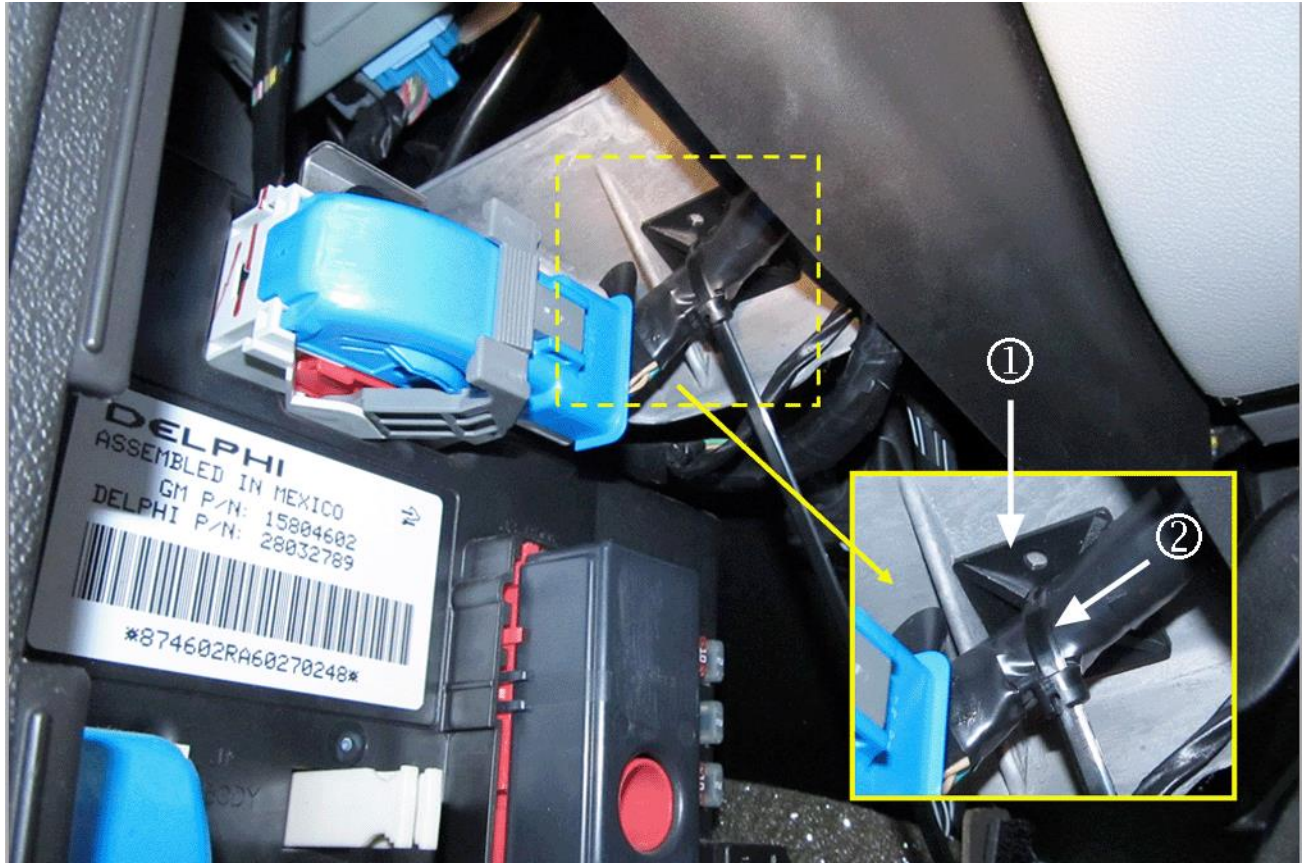

3963167

Note: DO NOT install the rubber spacer on the mount.

3. Peel the backing from the adhesive on the tie-down mount and install the mount (1) to the flat underside surface of IP Mag Beam, in the location shown in the graphic above.

Note: Be sure to carefully cinch the tie strap completely so the harness is secured.

4. Position the harness to the mount, install the long tie strap (2) through the slot on the mount, and carefully cinch the tie strap.

Special Coverage Adjustment

16188 Brake Lamp Malfunction



4694690

5. Install a long tie strap around the IP Mag Beam and the harness and carefully cinch the tie strap.

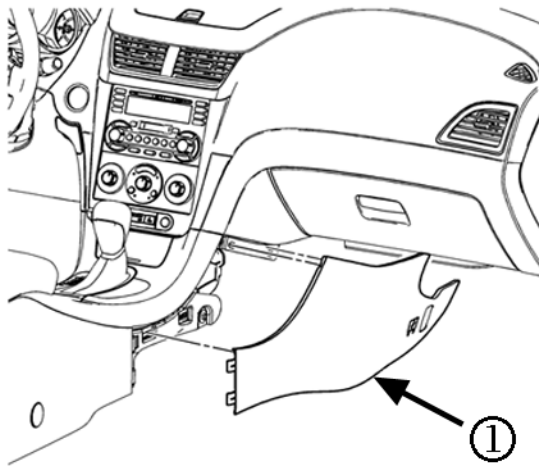

3963121

6. Reinstall the right side front floor console side trim panel (1).
7. Perform the brake pedal position sensor calibration. Refer to *Brake Pedal Position Sensor Calibration* in SI.
8. Verify proper operation of the brake lights.

Customer Notification

General Motors will notify Customers of this special coverage on their vehicle (see copy of typical Customer letter included with this bulletin).

Customer Reimbursement

Customer requests for reimbursement of previously paid repairs to correct the condition described in this bulletin are to be submitted to the dealer prior to or by March 31, 2018. See General Motors Service Policies and Procedures Manual, Section 6.1.11 – Product Field Action Customer Reimbursement Procedure (USA & Canada) or local Policies and Procedures, for details.

GM bulletins are intended for use by professional technicians, NOT a "do-it-yourselfer". They are written to inform these technicians of conditions that may occur on some vehicles, or to provide information that could assist in the proper service of a vehicle. Properly trained technicians have the tools, equipment, safety instructions, and know-how to do a job properly and safely. If a condition is described, **DO NOT** assume that the bulletin applies to your vehicle, or that your vehicle will have that condition. See your dealer for information on whether your vehicle may benefit from the information.



**We Support
Voluntary Technician
Certification**

Special Coverage Adjustment

16188 Brake Lamp Malfunction



March 2017

This notice applies to your vehicle, **VIN:** _____

Dear General Motors Customer:

As the owner of a 2004-2012 model year Chevrolet Malibu, 2004-2007 model year Chevrolet Malibu Maxx, 2005-2010 model year Pontiac G6, or 2007-2009 model year Saturn AURA your satisfaction with our product is very important to us.

This letter is intended to make you aware that some 2004-2012 model year Chevrolet Malibu, 2004-2007 model year Chevrolet Malibu Maxx, 2005-2010 model year Pontiac G6, and 2007-2009 model year Saturn AURA vehicles may have a condition where increased resistance in the body control module (BCM) connection system can result in voltage fluctuations or intermittency in the brake apply sensor (BAS) circuit that can cause brake lamp malfunction. Specifically, the brake lamps may either illuminate without the brake pedal applied, or turn off when the pedal is applied.

Do not take your vehicle to your GM dealer as a result of this letter unless you believe that your vehicle has the condition as described above.

What We Have Done: General Motors is providing owners with additional protection for the condition described above. If this condition occurs on your 2004-2012 model year Chevrolet Malibu, 2004-2007 model year Chevrolet Malibu Maxx, 2005-2010 model year Pontiac G6, or 2007-2009 model year Saturn AURA within 15 years of the date your vehicle was originally placed in service or 150,000 miles (240,000 km), whichever occurs first, the condition will be repaired for you at **no charge**. Diagnosis or repair for conditions other than the condition described above is not covered under this special coverage program.

What You Should Do: If you believe that your vehicle has the condition described above, repairs and adjustments qualifying under this special coverage must be performed by a General Motors dealer. You may want to contact your GM dealer to find out how long they will need to have your vehicle so that you may schedule the appointment at a time that is convenient for you. This will also allow your dealer to order parts if they are not already in stock. Keep this letter with your other important glove box literature for future reference.

Reimbursement: If you have paid for repairs for the condition described in this letter, please complete the enclosed reimbursement form and present it to your dealer with all required documents. Working with your dealer will expedite your request, however, if this is not convenient, you may mail the completed reimbursement form and all required documents to Reimbursement Department, PO Box 33170, Detroit, MI 48232-5170. The completed form and required documents must be presented to your dealer or received by the Reimbursement Department by March 31, 2018, unless state law specifies a longer reimbursement period.

The right to submit reimbursement claims is provided by GM solely in the interest of customer satisfaction and is personal to vehicle owners and lessees who previously paid for repairs referenced in this Special Coverage ("Customers"). **Customers may not assign and GM does not consent to any assignment of any Customer's right to submit reimbursement claims, or to receive reimbursement, or any other rights granted by this Special Coverage to any third party, including but not limited to service contract providers, and this Special Coverage is not intended to and does not confer any third party beneficiary, subrogation or contribution rights, or any other rights to reimbursement, against GM, whether in law, equity or otherwise, on any third parties.**

If you have any questions or need any assistance, please contact your dealer or the appropriate Customer Assistance Center at the number listed below.

Division	Number	Text Telephones (TTY)
Chevrolet	1-800-222-1020	1-800-833-2438
Pontiac	1-800-762-2737	1-800-833-7668
Saturn	1-800-553-6000	1-800-833-6000
Puerto Rico – English	1-800-496-9992	
Puerto Rico – Español	1-800-496-9993	
Virgin Islands	1-800-496-9994	

We are sorry for any inconvenience you may experience; however, we have taken this action in the interest of your continued satisfaction with our products.

Terry M. Inch
Executive Director
Global Connected Customer Experience

Enclosure
16188

GLOBAL SAFETY FIELD INVESTIGATIONS
DCS4367
URGENT - DISTRIBUTE IMMEDIATELY

Date: March 3, 2017

Subject: 16188 - Special Coverage
Brake Lamp Malfunction

Models: 2004-2012 Chevrolet Malibu
2004-2007 Chevrolet Malibu Maxx
2005-2010 Pontiac G6
2007-2009 Saturn AURA

To: All General Motors Dealers

General Motors is releasing Special Coverage 16188 today. The total number of U.S. vehicles involved is approximately 1.6 million. Please see the attached bulletin for details.

Customer Letter Mailing

The customer letter mailing will begin on March 31, 2017.

Global Warranty Management (GWM)

The Investigate Vehicle History (IVH) screen in the GWM system will be updated March 3, 2017. Please hold all warranty transactions until the VIN appears in IVH.

END OF MESSAGE
GLOBAL SAFETY FIELD INVESTIGATIONS