



Part number: H501SVC000
 Numéro de pièce:

Vehicle: WRX
 Véhicule:

Installation instructions
 Instructions d'installation

Description: Auto dimming mirror
 Description: Tetroviseur antiéblouissement

Kit contents

Contenu de la trousse

A

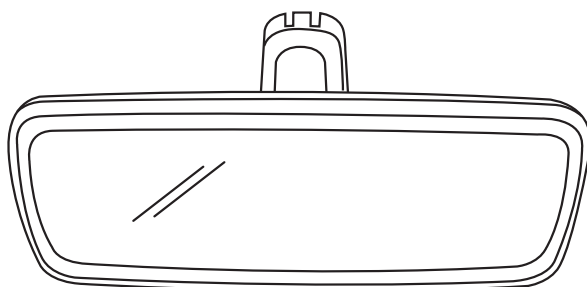

Auto dimming mirror
 Tetroviseur antiéblouissement

B

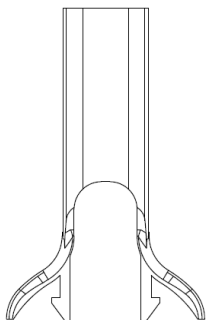

Wire harness cover
 Couvre-faisceau de câblage

C

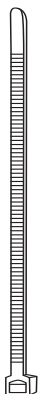

Wire Tie
 Attache autobloquante

D



Foam Tape
 Ruban mousse

Tools required

Outils requis



8 mm



10 mm



12 mm

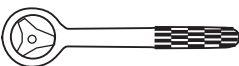

Wire Snips

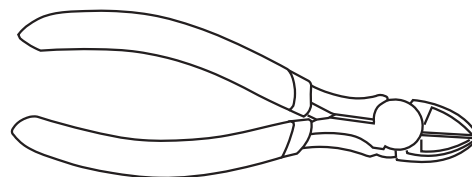

Panel removal tool
 Outil de dépose du panneau

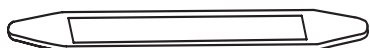

1

10 mm

12 mm

Disconnect battery. If equipped disconnect eyelet cable only.
Déconnectez la batterie. Si elle en est équipée, déconnectez le câble de l'œillet uniquement.

2

Remove original mirror by pulling on tab away from windshield and sliding mirror up and off the windshield mirror mount.
Retirez le rétroviseur d'origine en tirant sur la languette pour l'éloigner du pare-brise et en faisant glisser le rétroviseur vers le haut pour le sortir du support

3

1 - Remove cover with trim tool starting from the front.
1 - Retirez le couvercle à l'aide de l'outil pour garniture en commençant par l'avant.

4

1 - Remove two screws.
1 - Retirer les deux vis.

5

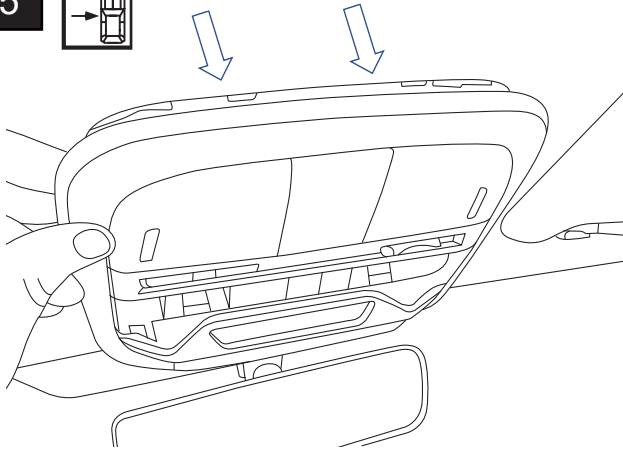

Gently pull down cover to release clips.
Tirez doucement le couvercle vers le bas pour libérer les attaches.

6

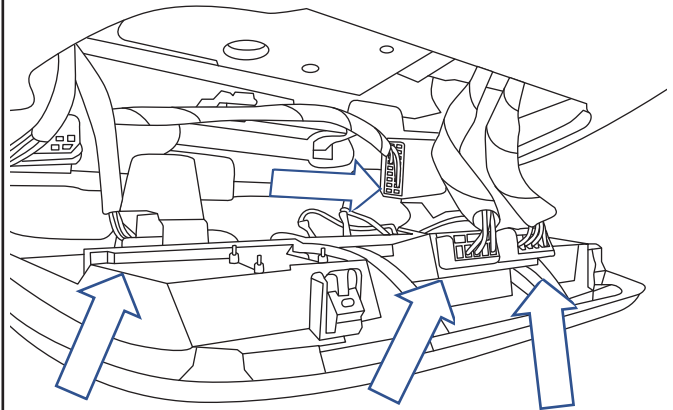

Disconnect harnesses from maplight/cover assembly.
Débrancher faisceaux de la lampe de lecture ou du couvercle.

7

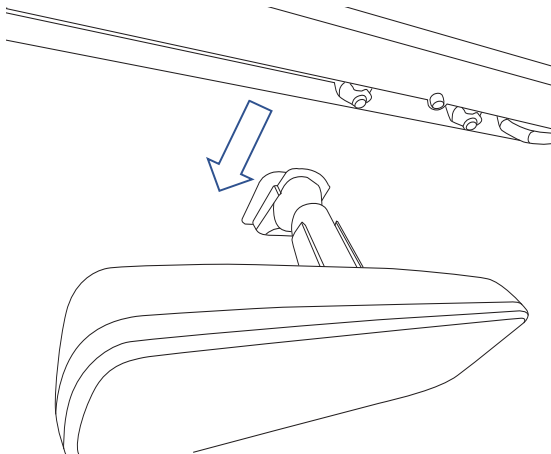

Install auto-dimming mirror by sliding mirror down onto the base. Tighten set screw with T-20 Torx bit to 13.3 – 17.7 in-lbs.
Installer le rétroviseur intérieur à atténuation automatique en le faisant glisser vers le bas sur la base. Serrer la vis de pression avec un embout Torx T-20 à 13,3 à 17,7 po-lb

8

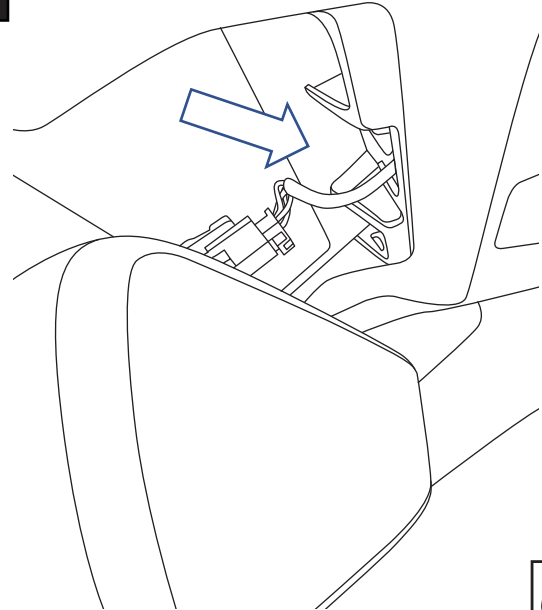

Route wire harness through Eyesight cover opening.
Faire passer le faisceau de câblage à travers l'ouverture du couvercle Eyesight.

PART NUMBER
H501SVC000

ISSUE
B

DATE
2/6/2024

SUBARU OF AMERICA

PAGE
3/5

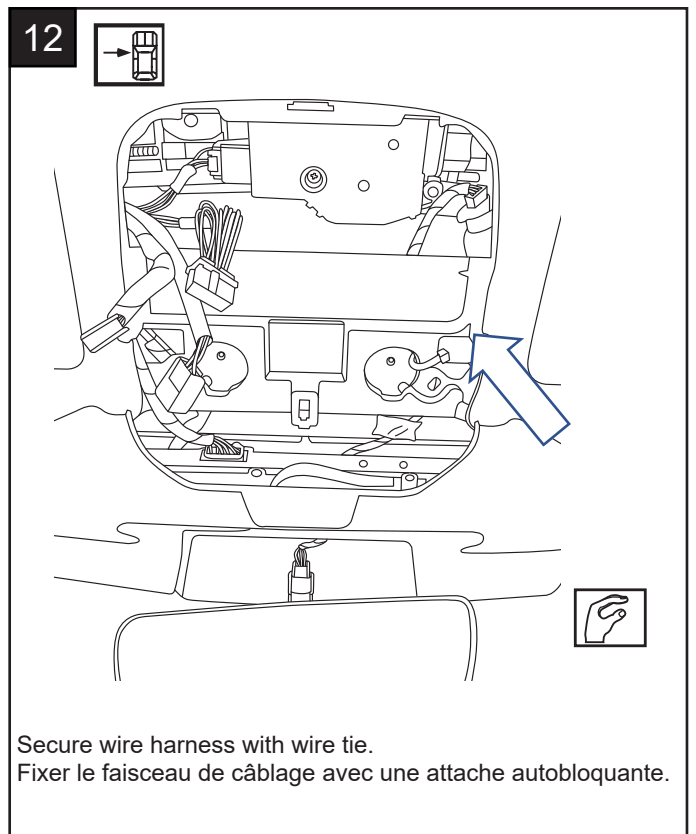
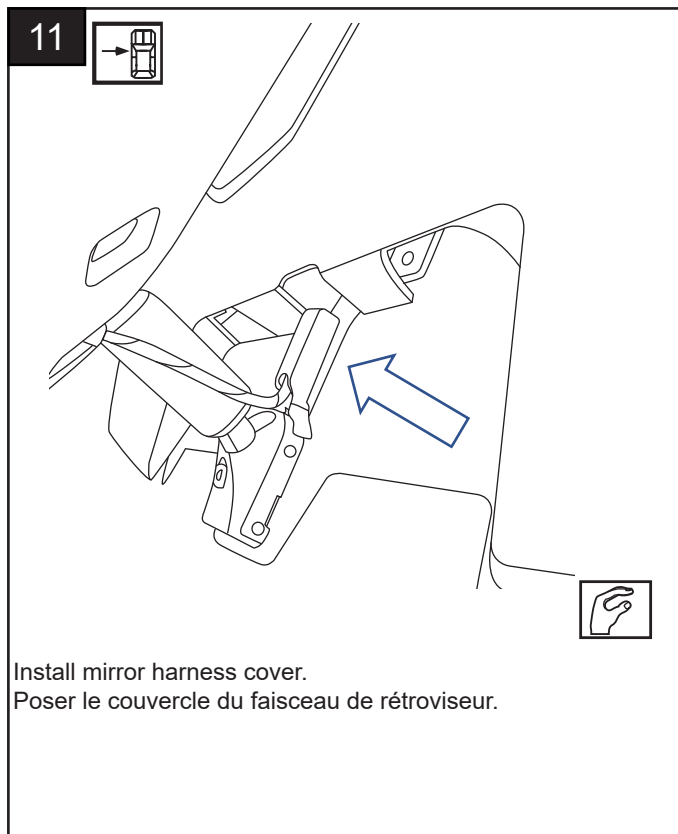
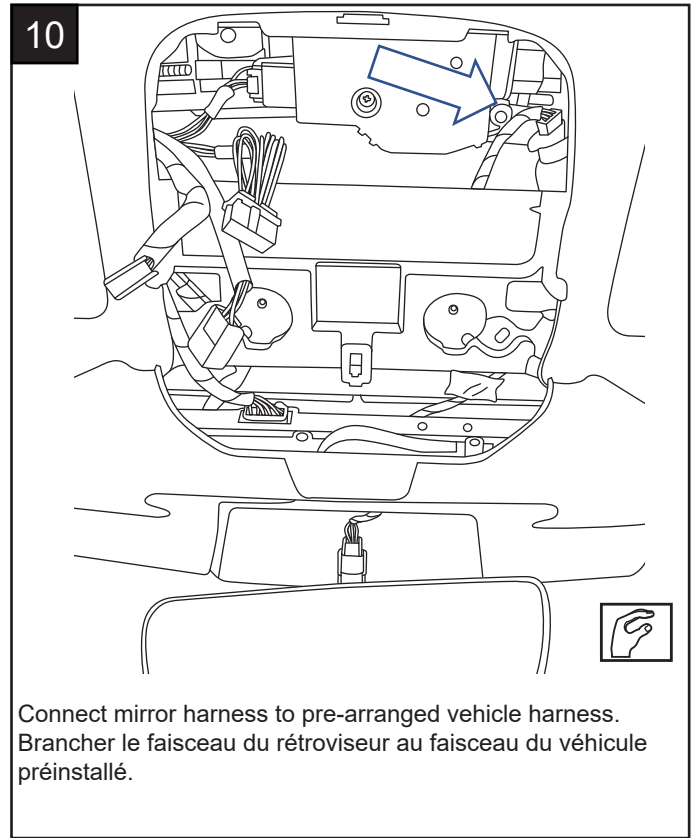
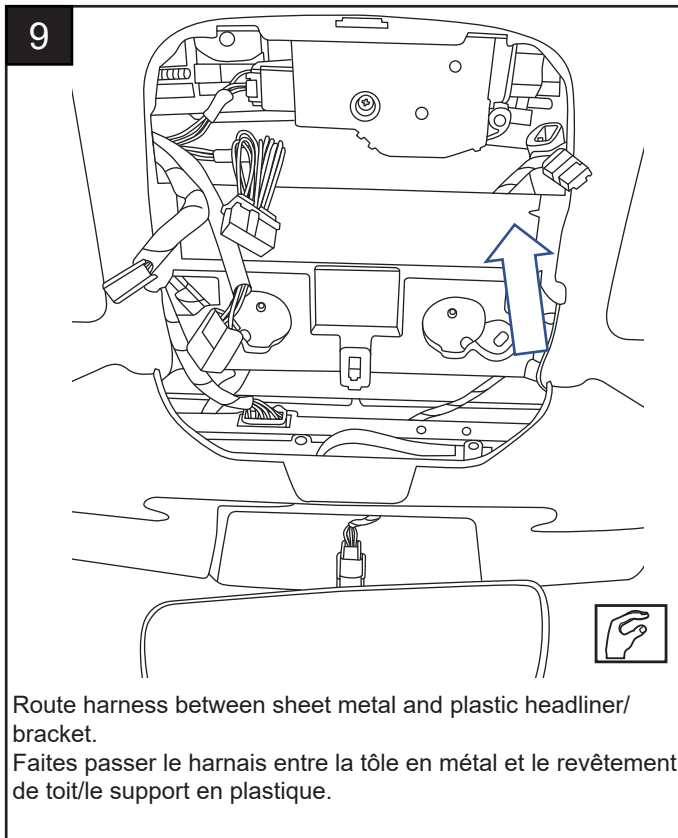

13

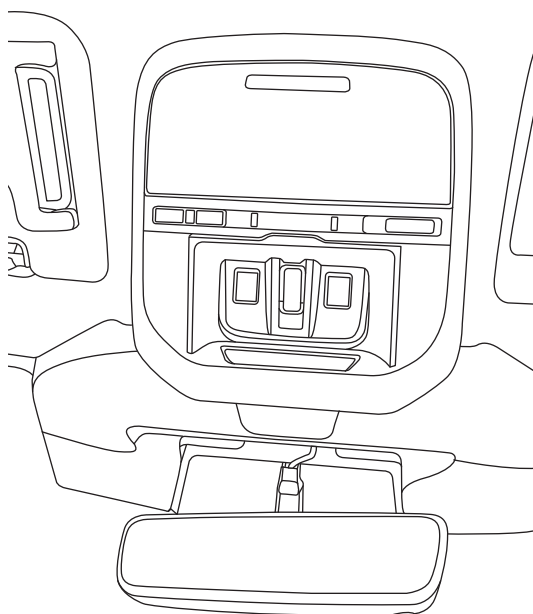

Reinstall map light/cover assembly.
Réinstaller la lampe de lecture ou le couvercle.

14

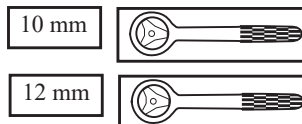
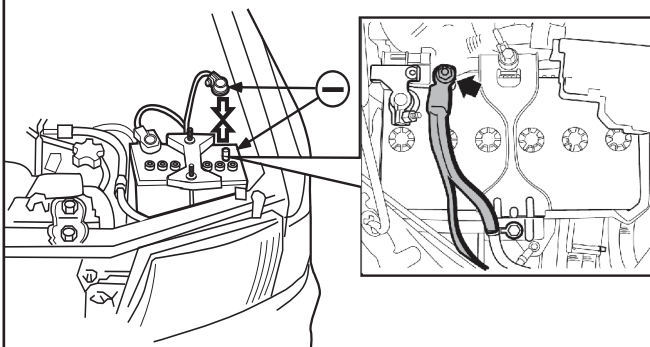

Reconnect battery. If equipped reconnect eyelet cable. Tighten bolt to 66 in-lbs.
Rebranchez la batterie. Si elle en est équipée, rebranchez le câble de l'œillet. Serrez les boulons à 66 po-lb.

15

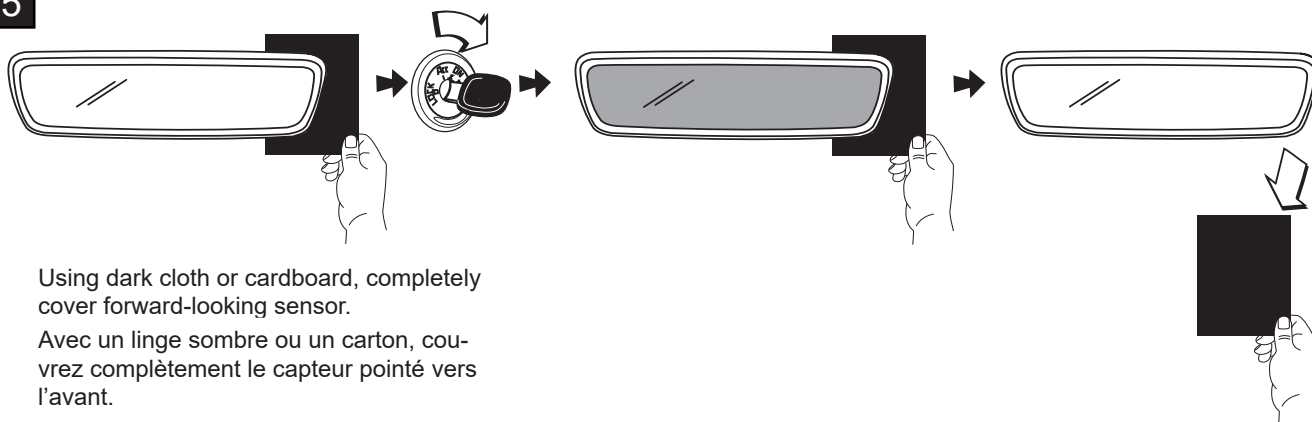

Using dark cloth or cardboard, completely cover forward-looking sensor.
Avec un linge sombre ou un carton, couvrez complètement le capteur pointé vers l'avant.

16

To calibrate compass reference mirror user guide.
Pour étalonner la boussole, reportez-vous au manuel du rétroviseur.