

Safety Recall – 2024 CX-90 - Steering Gear Safety Recall

A. VEHICLE INSPECTION PROCEDURE – AND PREPERATION FOR REPAIR

1. Verify that the vehicle is within the following ranges and there is a Not Launched or OPEN 6524A recall in eMDCS:

SUBJECT VEHICLES

Model	Subject VIN range	Subject production date range
2024 CX-90	JM3 KK ****R1 100044 – 152900	From December 27, 2022 through December 11, 2023

*Only the vehicles in this range and with a “Not Launched” or “Open” status in eMDCS are affected. If the vehicle is in the range above and 6524A is OPEN or Not Launched in eMDCS, proceed to Step 2. If the vehicle does not have an OPEN or Not Launched 6524A campaign, return the vehicle to the customer or inventory. **Not Launched only means the owner letters have not been sent, the status DOES NOT mean do not repair.**

2. Perform an eMDCS Warranty Vehicle Inquiry and inspect the vehicle for a Campaign Label with **6524A** attached to the vehicle’s hood, driver door or firewall.

NOTE: Always sure to verify the campaign number as the vehicle may have multiple campaign labels on the hood, radiator support, firewall or driver door jamb.

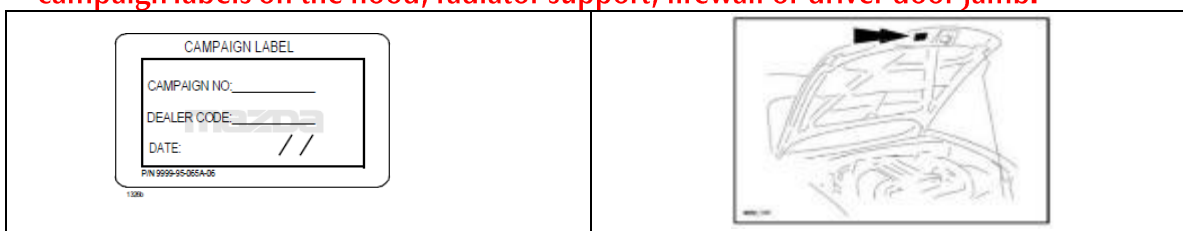

eMDCS - Warranty Vehicle Inquiry Results:

If eMDCS displays:	Campaign Label is:	Action to perform:
If no repair date is displayed on the line with CAMPAIGN 6524A, it has not been completed on this vehicle	Present	Fill out Dealer Recall Help on OneMazda contact or the Mazda Warranty Department at warrantydept@mazdausa.com to review vehicle history.
	Not present	Proceed to “REPAIR PROCEDURE”.
If repair date is displayed for CAMPAIGN 6524A is “CLOSED”	Present	Return vehicle to inventory or customer.
	Not present	Complete a label and apply to vehicle’s hood with repair date and dealer code from eMDCS Warranty Inquiry.
CAMPAIGN 6524A is not displayed	See Action	The vehicle is not affected by Recall 6524A

GENERAL CAUTIONS/WARNINGS – PLEASE READ:



Air Bag Connectors and Battery Disconnect: Unless a battery connection or engine running is required, do not work on the vehicle without disconnecting the vehicle battery as this could result in damage to the vehicle or safety systems.

Customer Personal Items: If personal belongings need to be removed from vehicle interior trunk area or inside, please remember to neatly replace any customer items in the same location after the repair is completed. If items need to be removed, please kindly ask the customer to remove prior to beginning work on the vehicle.

Damage to interior or exterior: Care should be taken, and protective cover(s) used when working on any Mazda vehicle. Damage to any components, interior trim, vehicle accessories, body panels and paint will not be reimbursed by Mazda (including OEM or aftermarket).

All of these items above could delay repairs, compromise safety, as well as negatively affect the customer experience and Mazda dealer-customer relationship.

B. REPAIR PROCEDURE



1. Four photos are required for the warranty claim. Make sure to take all four (4) photos during the repair.
2. Obtain the correct recall part from your parts department: Mazda PN# K1Y0-32-FX8A

Tools Required
Torque Wrench, in-lb and ft-lb
Plastic pry tool
10mm box end wrench
10mm Hex/Allen Socket
1/4 or 3/8 Ratchet
6-7 inch Ratchet extension
Neoprene Gloves

Parts Kit Contents: K1Y0-32-FX8A

CAUTION: Do not handle parts in this campaign with bare hands, always use Neoprene gloves when handling all parts.

1. O-ring
2. 2 new 10mm bolts
3. Outer Cap
4. Plastic strips (2)
5. Pink grease for new nut, spring and cap
6. Inner Cap
7. Spring (All Black in Color)



1. Leave Hood Closed. Lift Vehicle and remove the #3 front engine cover, do not remove covers #1 and #2. Follow steps in MGSS for removal. Refer to MGSS online ([FRONT UNDER COVER # 3 REMOVAL / INSTALLATION](#))

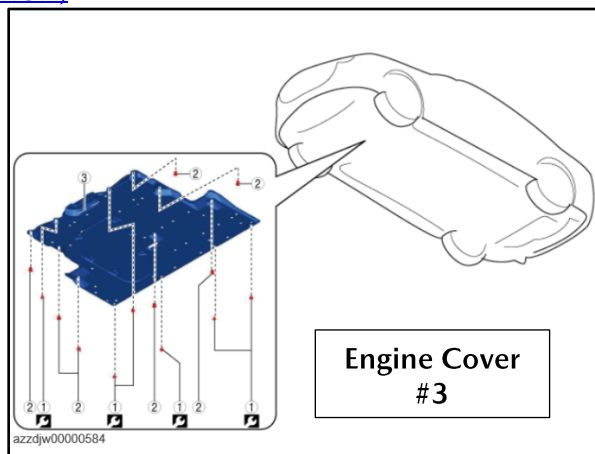

Step	Part name	Applicable condition	Tightening torque
1	Bolt	All models	95 lbf-in (11 N·m)
2	Fastener	All models	—
3	Front undercover No.3	All models	—

1. In order to prevent contamination later in the procedure, (step 4), wash away with water, any slush, snow, sand, mud, etc. around the steering gear and dry the entire area with an air gun (Figure A). Use Parts Cleaner if needed to completely clean the area to avoid any contamination.

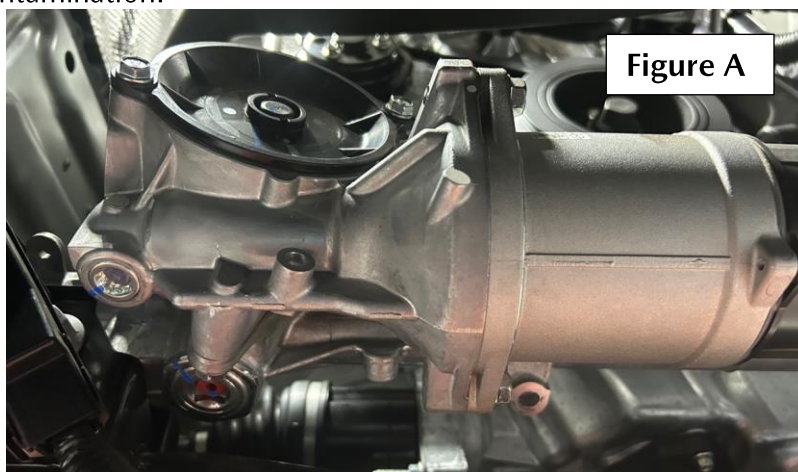

2. Loosen the two bolts for the black cover (Figure B) on the top of the steering motor to the point where the threads are visible by roughly 1/8" (3 mm).

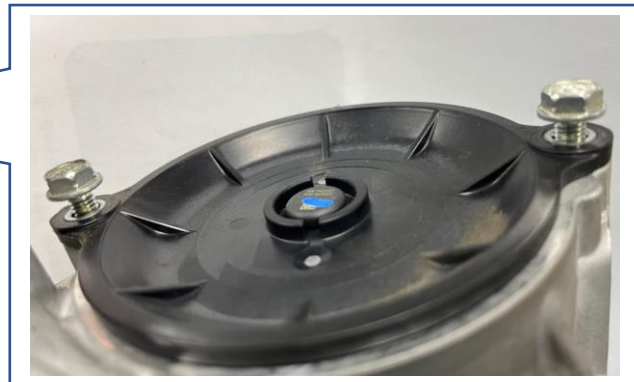
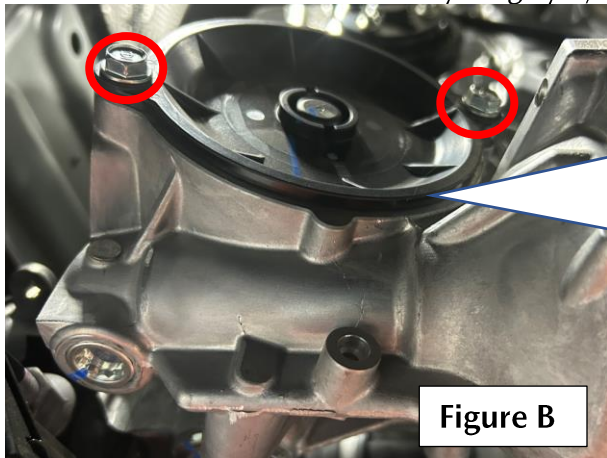

3. Gently use a plastic door trim tool to remove the black cover so that it slowly pops up and rests against the loosened bolts (Figure C). You will need to gently insert the pry tool several times rocking the piece slowly up left-to-right (A), (B), (C), (D), and (E). Do not use any excessive force. (Figure D). There is an O-Ring on this cover that makes it difficult to remove by hand. [PLEASE CLICK HERE TO WATCH THE VIDEO OF THIS PROCEDURE STEP.](#)



Do not use a metal pry tool or flathead screwdriver, as this will cause damage/deform the aluminum case. Deformation or cracking of the black cover will allow moisture to enter the worm gear breaking down the grease resulting in rusted parts. Costs to replace damage to these components caused by incorrect tool use/improper repair will be absorbed by the Mazda dealer causing customer frustration and delay of repairs.

Figure C

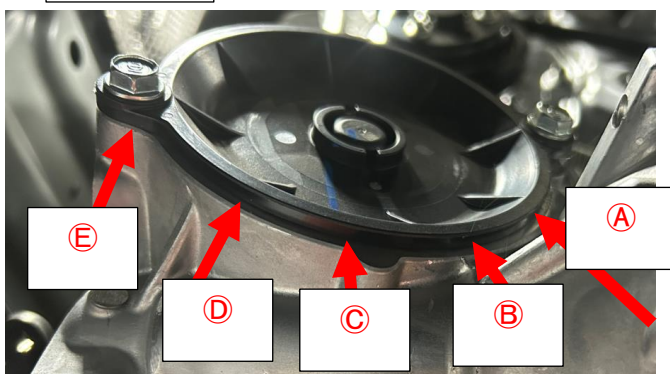
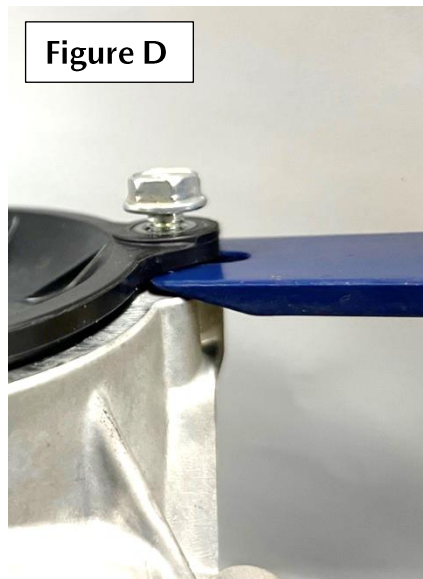

Figure D



4. Once the cover has been loosened and is against the bolts, remove both bolts and remove the cover by hand. It does not take much force with the tool to pop up the cover.
5. WASH YOUR HANDS COMPLETELY AND DRY THEM. Take out the plastic plate in the replacement parts kit and place it on a clean cloth (Figure E). Use a clean Neoprene glove.



Figure E

6. Using your gloved finger, press the grease into the gap between the aluminum case and the worm gear insert around the worm gear Figure G, which adheres to the area of the blue frame in Figure H. Note G is showing a Right Hand Drive Steering Rack.

BEFORE

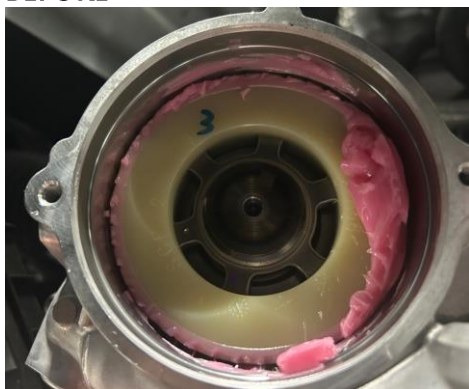

Figure G

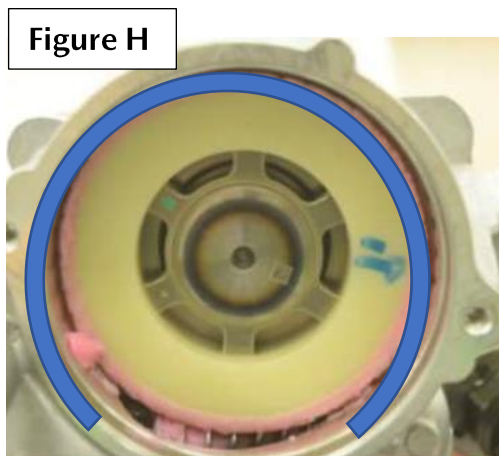

Figure H

a. Flow of pushing grease into the gap is below

CAUTION: Do not push grease in with your bare hands! If you work with your bare hands, dirt and foreign matter will get inside, which can result in poor steering performance or binding of the steering gear. [PLEASE CLICK HERE TO WATCH THE VIDEO OF THIS PROCEDURE STEP.](#)

Push the protruded grease (pink) (1) into the gap between the worm wheel (2) and the housing (3) with a finger covered with the new glove as per the following image.

NOTE: There are variations in the amount of the grease attached to the worm wheel. Even if the amount is small, perform this procedure.

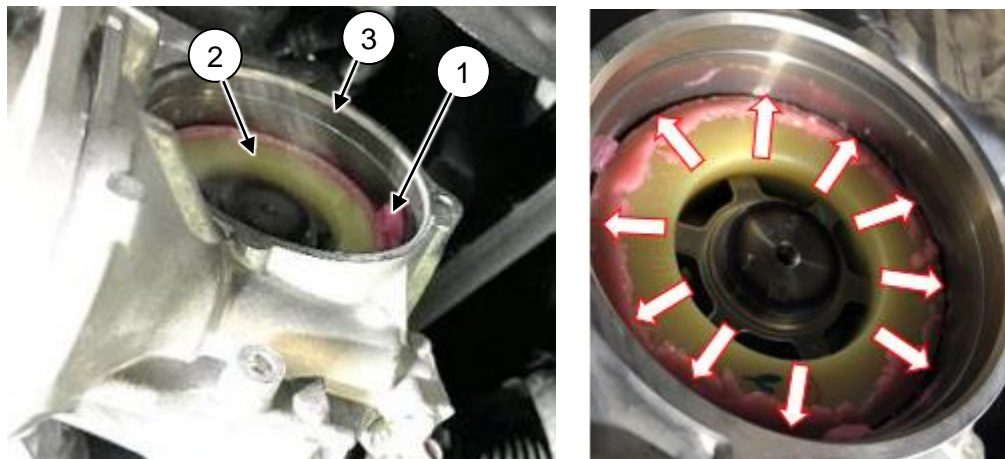

7. Place the plastic plate between the aluminum case and the worm gear, align the range of the blue frame in the figure below twice on the left and right, and press the pink grease on the groove part of the gear.

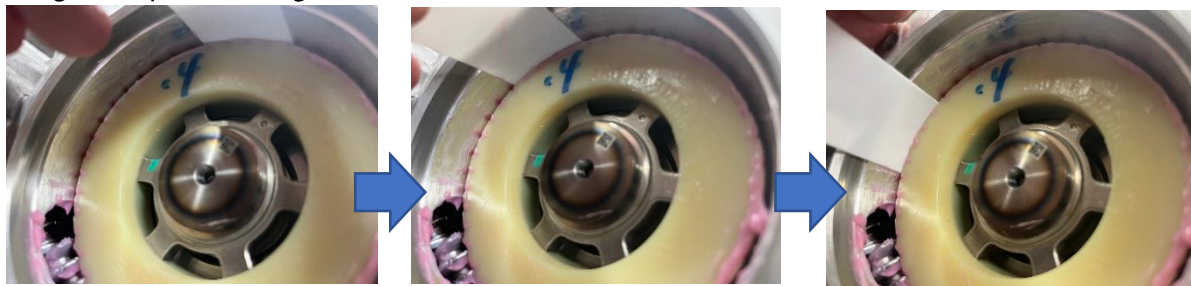

When you are done this is what this looks like. You can see that the plastic tool has pushed the grease into the teeth of the gear.

AFTER PRESSING GREASE IN

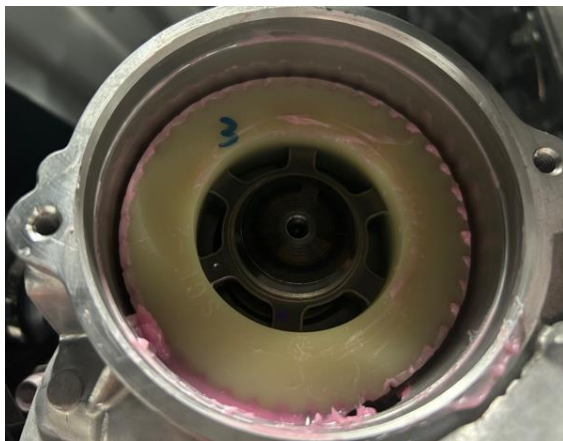

8. PHOTO REQUIREMENT #1 and 2: Write the RO# on the Steering Gear Case.

Take two photos, one with pink grease blended into the gear teeth and the other with the RO in the photo and RO on the gear case. The photos must be taken properly, or the warranty claim will not be approved. Make sure it is clear like the below as this will be 100% reviewed.

PHOTO #1

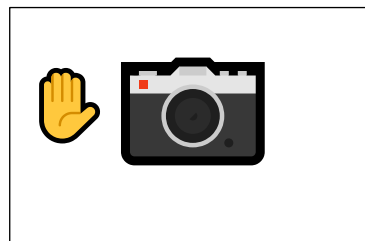
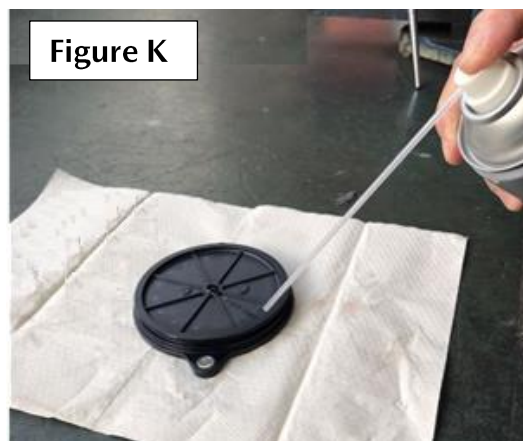
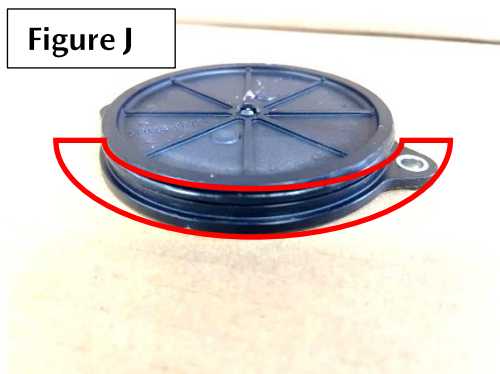

PHOTO #2



9. Discard the plastic plate used to press in the grease.
10. O-Ring removal and Cover cleaning:
 - a. Figure J. Remove the O-ring in Figure J on the outer periphery of the black cover and discard the O-ring.
 - b. Figure K. Place the black cover on a clean cloth and clean the housing contact surface of the aluminum case with a non-corrosive parts cleaner that does not degrade plastic or metal.
 - c. Figure L. Thoroughly remove dirt from the O-ring groove with a parts cleaner. Install the new O-ring in the parts kit.



PLACE GREASE ON THE ENTIRE O-RING

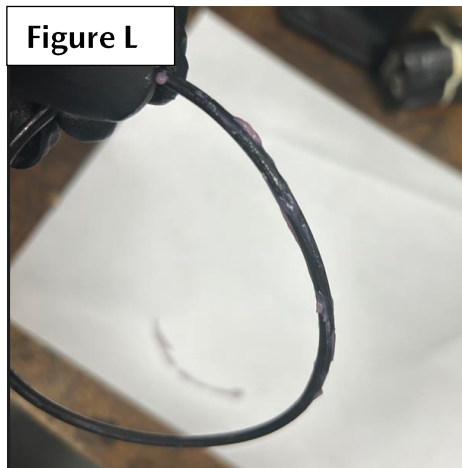

11. Install the black cover, but do not push down completely. Leave a gap and insert the bolts a few turns holding the black cover in place. Refer to Figure L.

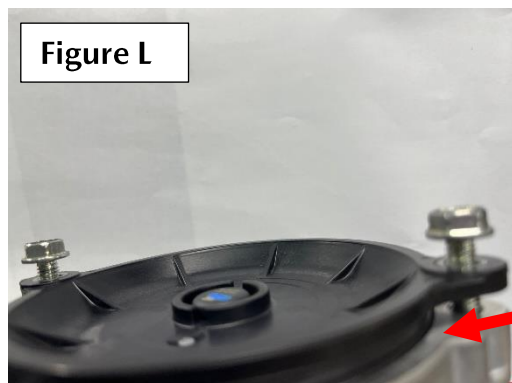

Gap in cover

12. Gently push the black cover into the aluminum case housing surface (Figure M) and tighten the bolts with the specification below (Figure N).

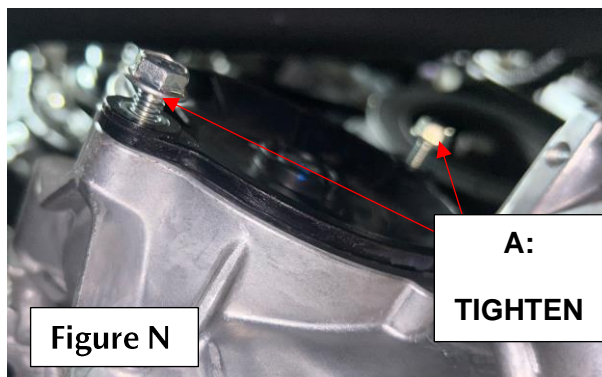
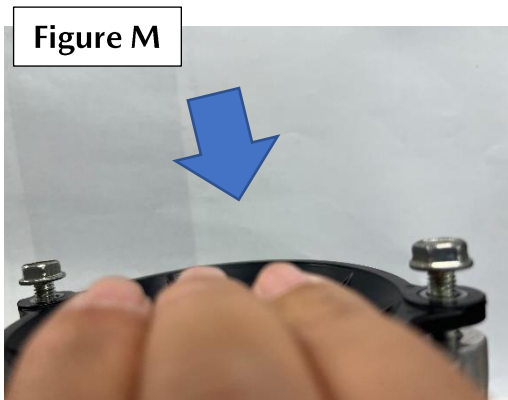

Black cover bolts	Tightening torque
A	6-7lbf-ft (8 – 10) N·m

13. **End Cap Spring Replacement:** Use a T10 hex wrench to remove the end cap in Figure O.

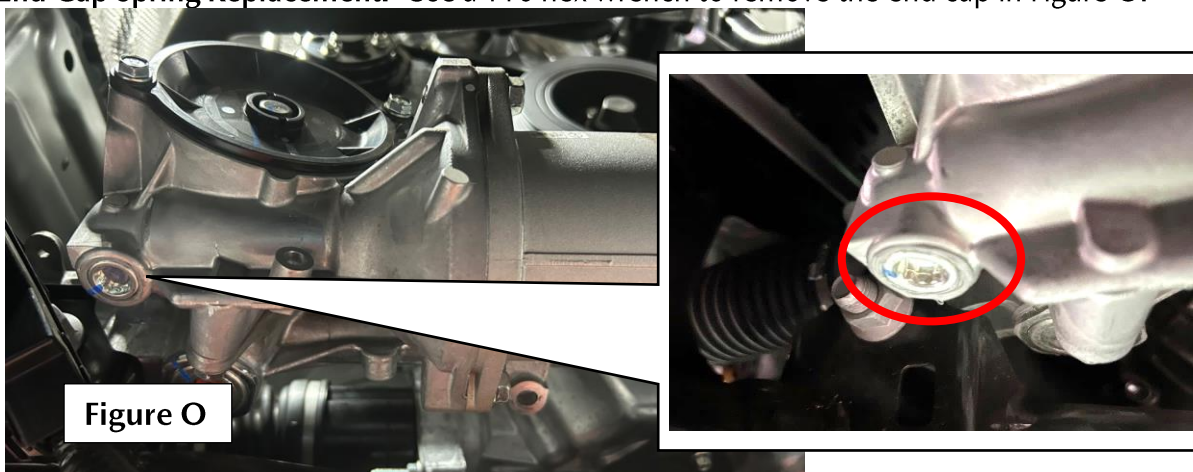



14. Clean off a medium or long needle nose pliers and remove the spring and/or cap inside if needed. The tool must be cleaned to prevent any contamination. Visually inspect the inside and make sure that there are no springs and caps.

Correct - Normal condition: After spring and cap are removed.

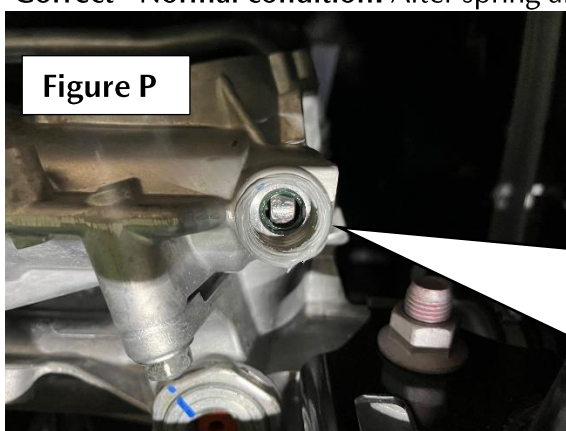

NO GOOD – Incorrect condition: Spring is not removed

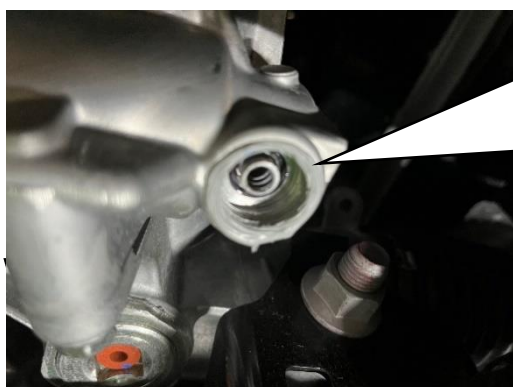

NO GOOD (NG) – Incorrect condition: Cap is not removed

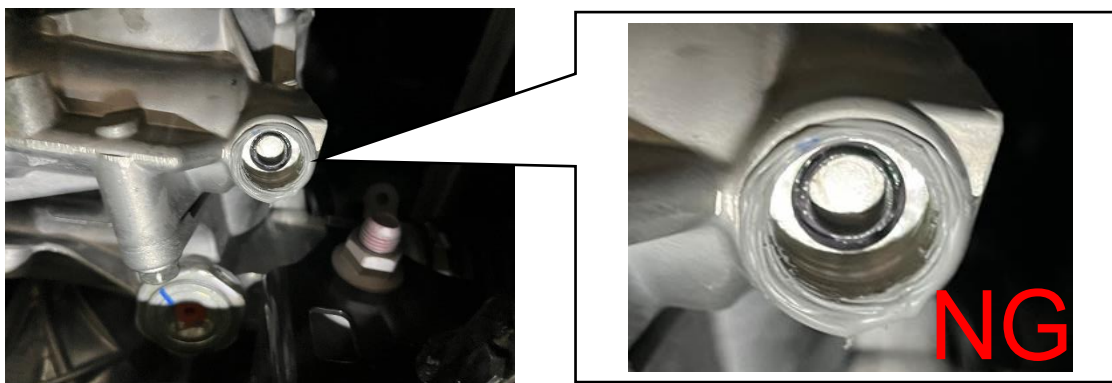

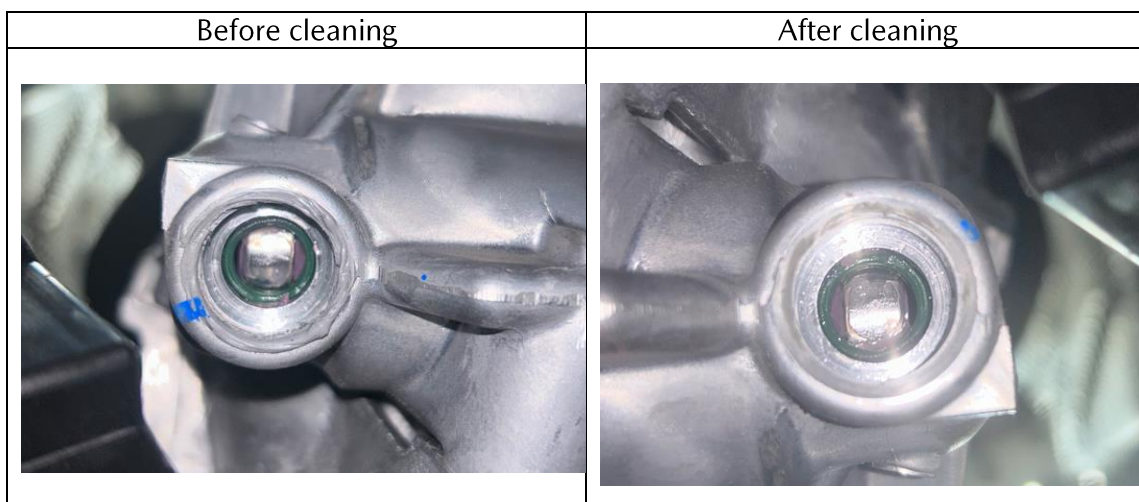

15. Remove all of the sealer on the end cap mounting surface. Use a new clean glove to remove the gray sealer applied to the threaded part of the end cap mounting surface. Remove any remaining sealer, with a clean rag and parts cleaner as necessary. by inserting it into the end cap attachment part and removing the sealant from right to left.

CAUTION: Do not rotate to the right. If you rotate it to the right, the sealer might get pushed into the housing.



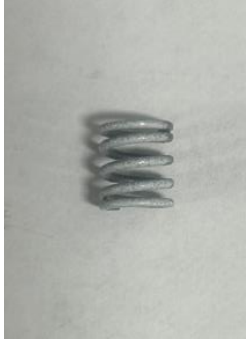

16. Take out the cap, spring, end cap, and grease from the replacement parts kit and replace into the hole. Apply the grease to both ends of the spring and the tip of the cap. Grease is applied to prevent parts from falling during installation. NOTE: Wire Diameter is smaller.

Old Spring Color: Half White Coil	New Spring Color: Black All Coils
	

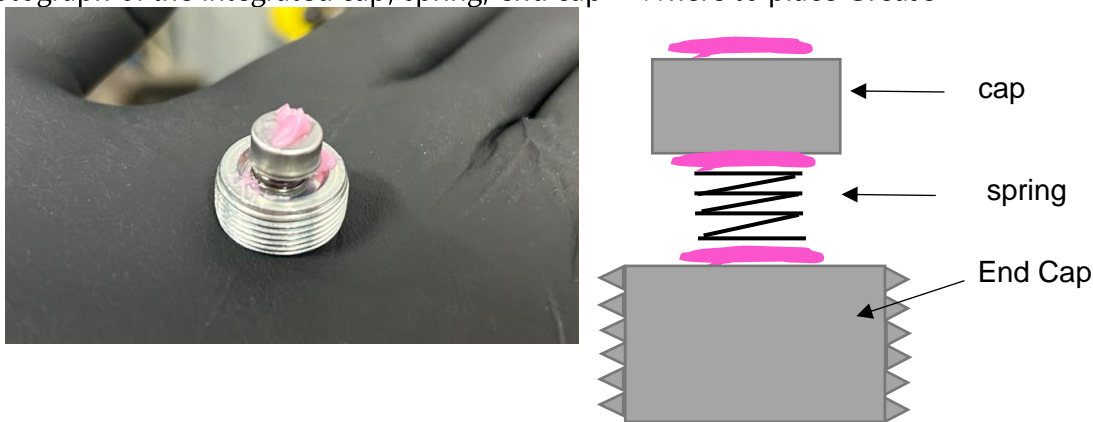
Photograph of the integrated cap, spring, end cap Where to place Grease



➤ Position and direction of the spring and spring seat

Good	No Good	
		
--	The spring seat is placed upside down.	The spring and the spring seat are reversed.

17. PHOTO REQUIREMENT #3: Take a photo for the warranty claim.

With the RO# in the photo, take a photo so that the integrated cap, spring, end cap, and old spring, which are replacement parts, are in the photo. (Note, this photo is a little low and you do not see the RO# on the rack. Make sure the RO# is present in the photo like #4

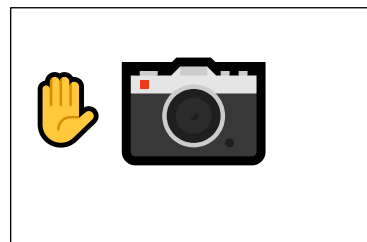

18. After taking photo #2, start the threads of the integrated cap, spring, and end cap (should be approximately 2 turns).

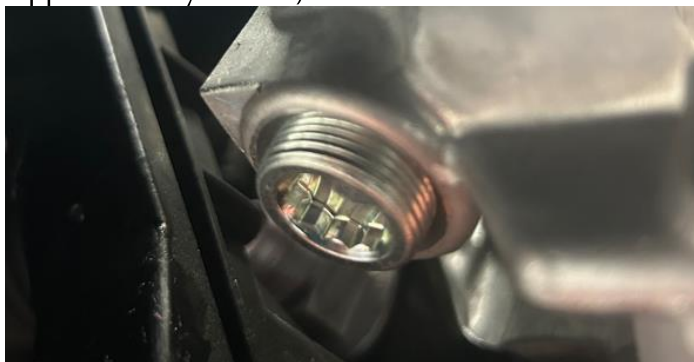

19. Apply a silicone liquid gasket (0000-77-1217-ES Mazda required sealant) to the thread of the end cap and tighten it. This tube will repair at least 25 vehicles. [PLEASE CLICK HERE TO WATCH THE VIDEO OF THE PROCEDURE.](#) **NOTE: THE SEALANT IS GRAY IN COLOR FROM PN# 0000-77-1217-ES)**

Tightening torque: 9-12 lbf-ft (12-16 N-m)

BEFORE TORQUE WITH GREASE



AFTER TORQUE

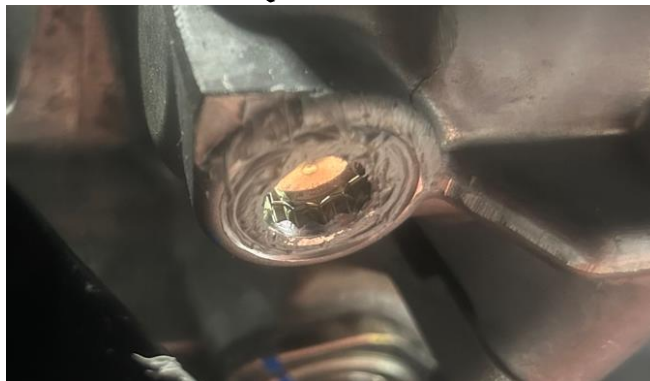

20. PHOTO REQUIREMENT #4. Take a photo for a warranty claim.
Take a photo so that the black cover and end cap are visible.

NOTE: THE RO ON THE CASE MUST MATCH THE RO IN THE PHOTO, THIS WILL BE CHECKED.

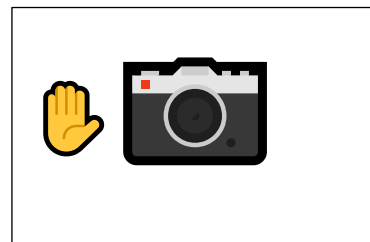
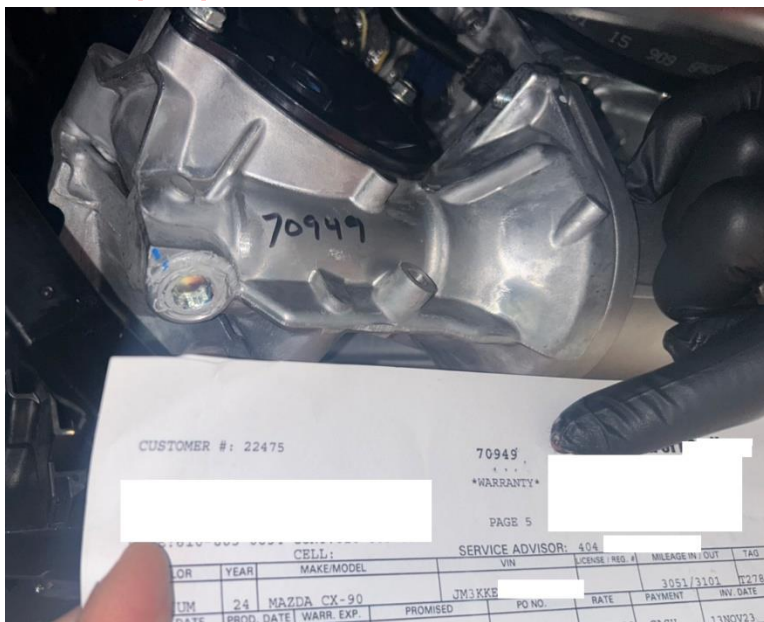

21. Reinstall the #3 Under Cover. Refer to MGSS online ([FRONT UNDER COVER # 3 REMOVAL / INSTALLATION](#))

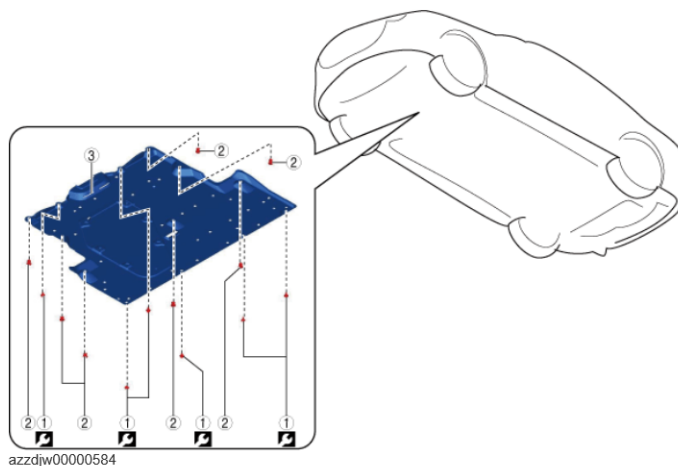

Step	Part name	Applicable condition	Tightening torque
1	Bolt	All models	11 N·m {110 kgf·cm, 95 in·lbf}
2	Fastener	All models	—
3	Front undercover No.3	All models	—

22. Steering operation check:

- a. Lower the vehicle to approximately 1 ft from the ground, on the lift
- b. Push the start button to the IG-ON position (engine does not start/PHEV is not Ready- ON)
- c. Make one full steering wheel revolution, from full left to full right, lock-to-lock
- d. Follow the flow chart to make sure that there is no binding in the steering wheel

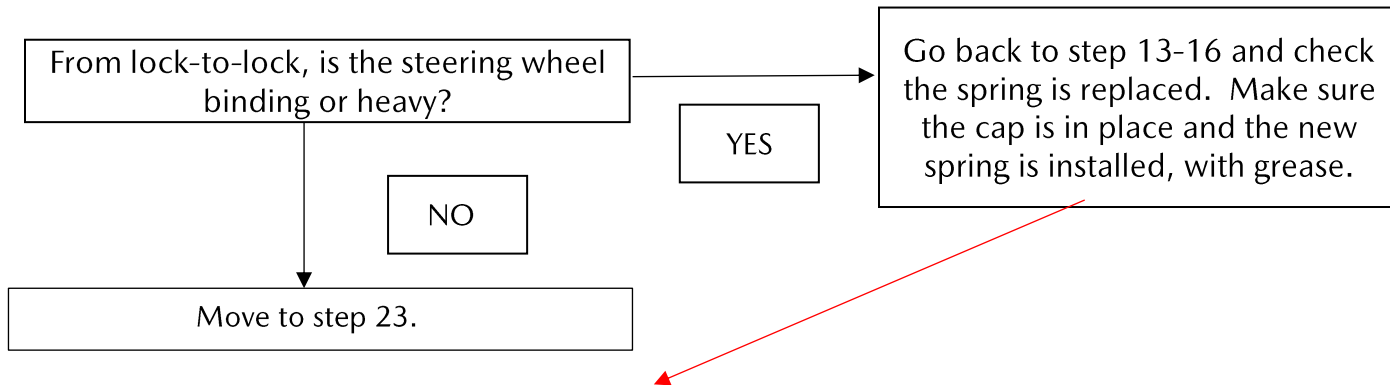

- If the steering is binding or heavy when turning the steering wheel:
 - Check if the removed spring is outside half white.
 - Check if the pushing grease procedure has been done properly.
- If steering wheel is heavy to turn:
Verify that there the spring seat is removed. Steering wheel becomes heavy if the old spring seat remains in the housing.

23. Place the vehicle on the ground, and open the hood. Move to Section C. Campaign Label Replacement.

C. CAMPAIGN LABEL INSTALLATION

- a. Fill out a Black "Campaign Label" (9999-95-055A-06) with Campaign #: "6524A", your dealer code, and the repair date.

The image shows a rectangular form titled "CAMPAIGN LABEL". It contains three fields: "CAMPAIGN NO:" with a line for "6524A", "DEALER CODE:" with a line for a partially obscured code, and "DATE:" with two lines for the date. At the bottom left, it says "PIN 9999-95-055A-06".

- b. Affix it to the hood as shown. If you cannot place the label here, the radiator support, firewall or driver door jamb are acceptable locations:

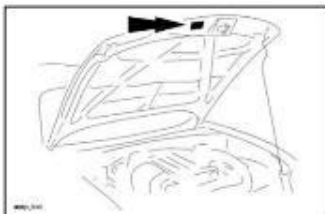

END OF REPAIR PROCEDURE