

- ATTENTION:**
- GENERAL MANAGER
 - PARTS MANAGER
 - CLAIMS PERSONNEL
 - SERVICE MANAGER

IMPORTANT - All Service Personnel Should Read and Initial in the boxes provided, right.

© 2023 Subaru of America, Inc. All rights reserved.



QUALITY DRIVEN® SERVICE

PRODUCT CAMPAIGN BULLETIN

APPLICABILITY: 2023MY WRX
 2024MY Crosstrek
 2024MY Impreza
 2023-2024MY Forester

NUMBER: WRP-23
DATE: 12/19/23
NHTSA ID: 23V-754

SUBJECT: Safety Recall – Driveshaft Failure

Subaru of America, Inc. (Subaru) has initiated a safety recall for certain 2023 model year WRX vehicles, certain 2024 model year Crosstrek and Impreza vehicles, and certain 2023-2024 model year Forester vehicles.

The vehicles included in this recall may be equipped with a front drive shaft assembly with an outer race that could crack, due to improper cooling during the manufacturing process.

Over time, a cracked outer race could break, potentially resulting in loss of motive power. Additionally, if the outer race breaks, the vehicle may roll when parked if the parking brake is not applied. Both conditions increase the risk of a crash.

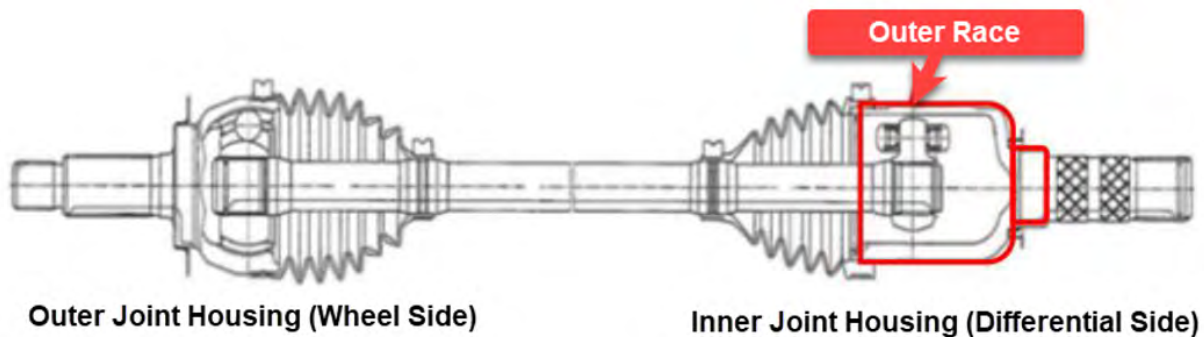

REMEDY:

For all potentially affected vehicles, Subaru dealers will inspect the left-hand and right-hand front drive shafts and where necessary, replace them with a new one at no cost to the customer.

<p>CAUTION: VEHICLE SERVICING PERFORMED BY UNTRAINED PERSONS COULD RESULT IN SERIOUS INJURY TO THOSE PERSONS OR TO OTHERS.</p> <p>Subaru Service Bulletins are intended for use by professional technicians ONLY. They are written to inform those technicians of conditions that may occur in some vehicles, or to provide information that could assist in the proper servicing of the vehicle. Properly trained technicians have the equipment, tools, safety instructions, and know-how to do the job correctly and safely. If a condition is described, DO NOT assume that this Service Bulletin applies to your vehicle, or that your vehicle will have that condition.</p>	<p style="text-align: center;">Subaru of America, Inc. is ISO 14001 Compliant</p> <p>ISO 14001 is the international standard for excellence in Environmental Management Systems. Please recycle or dispose of automotive products in a manner that is friendly to our environment and in accordance with all local, state and federal laws and regulations.</p>
--	--

Continued...

AFFECTED VEHICLES:

A total of 3,732 U.S. vehicles will be included in this recall as listed below. Not all vehicles in the production range listed below are affected by this recall. Coverage must be confirmed by using the Vehicle Coverage Inquiry function on subarunet.com prior to repair.

Model Year	Carline	Production Date Range
2023	WRX	9/1/2023 – 9/13/2023
2024	Crosstrek	9/5/2023 – 9/13/2023
2024	Impreza	9/6/2023 – 9/7/2023
2023-2024	Forester	9/4/2023 – 9/14/2023

RETAILER RESPONSIBILITY:

Please be advised that it is a violation of Federal law for a dealer to deliver a new motor vehicle covered by a recall under a sale or lease until the defect is remedied. Therefore, any Authorized Subaru Retailer failing to perform the applicable service procedures to correct all affected vehicles in their inventory prior to the vehicle being placed in service may be subject to civil penalties of up to \$26,315 per violation (i.e., for each vehicle), as provided in 49 CFR §578.6 and will also be in breach of the Subaru Dealer Agreement.

Any vehicles listed in any recall/campaign that are in retailer stock must be:

- Immediately identified.
- Tagged or otherwise marked to prevent their delivery or use prior to repair.
- Repaired in accordance with the repair procedures outlined in the Product Campaign Bulletin.

Retailers are to promptly perform the applicable service procedures, to correct all affected vehicles in their inventory (used, demo & SSLP). Whenever a vehicle subject to this recall is taken into retailer inventory necessary steps should be taken to ensure the recall correction has been made before selling or releasing the vehicle.





OWNER NOTIFICATION:

Subaru will notify affected vehicle owners by first class mail on January 8, 2024.

Continued...

PART INFORMATION:

IMPORTANT: The drive shaft assemblies apply to both left and right sides. ALWAYS confirm the correct number of drive shafts required before placing an order.







Drive Shaft Part Information				
Model	Part Name	Part Number	Qty	Part Identification Label on The Box
Impreza	DRV SFT ASSY	28321FN0009S	1	
Crosstrek	DRV SFT ASSY	28321FN0309S	1	
Forester	DRV SFT ASSY	28321SJ0109S	1	
WRX	DRV SFT ASSY	28321VC0209S	1	
All (if required)	One-Time Use Parts Kit	X803926090	1	N/A
	80W-90 LSD Gear Oil	SOA427V1800	1	N/A
	75-90 H.P. Gear Oil (Suitable Alternative)	SOA427V1700	1	N/A
	Oil Seal	803918060	As Needed	N/A

IMPORTANT: All orders MUST be placed through RPM and not via PRIME or any other channel. Part orders should be placed **ONLY** after vehicle inspection reveal a need for parts. Any orders placed for parts and one-time use parts must be placed with the last 8 digits of open recall VIN listed in the PO reference field. Orders placed without a valid open recall VIN in the PO reference field will be canceled.

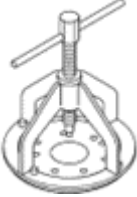
Valid open recall orders will be released within 24 hours without having to call the PICs for release. If you have any questions contact the PIC line at (866) 782-2782 option 1.

Continued...

REQUIRED TOOLS:

Tool Name	Tool Number	Image	Details
Axle Shaft Puller or Equivalent Tool	926470000 + 28099PA110		For removing drive shaft (As needed)
Differential Side Oil Seal Installer or Equivalent Tool	18675AA000		For installing the oil seal
Oil Seal Protector	28399SA010		For installing drive shaft (As needed)
Torx Socket T70	N/A		For removing drain plug
Tire Lever or Suitable Pry Bar	N/A		For removing drive shaft and oil seal
Wooden Block	N/A		For removing drive shaft and oil seal
Clean Cloth	N/A		For protecting ball joint boot

Continued...

SERVICE PROCEDURE FLOWCHART:

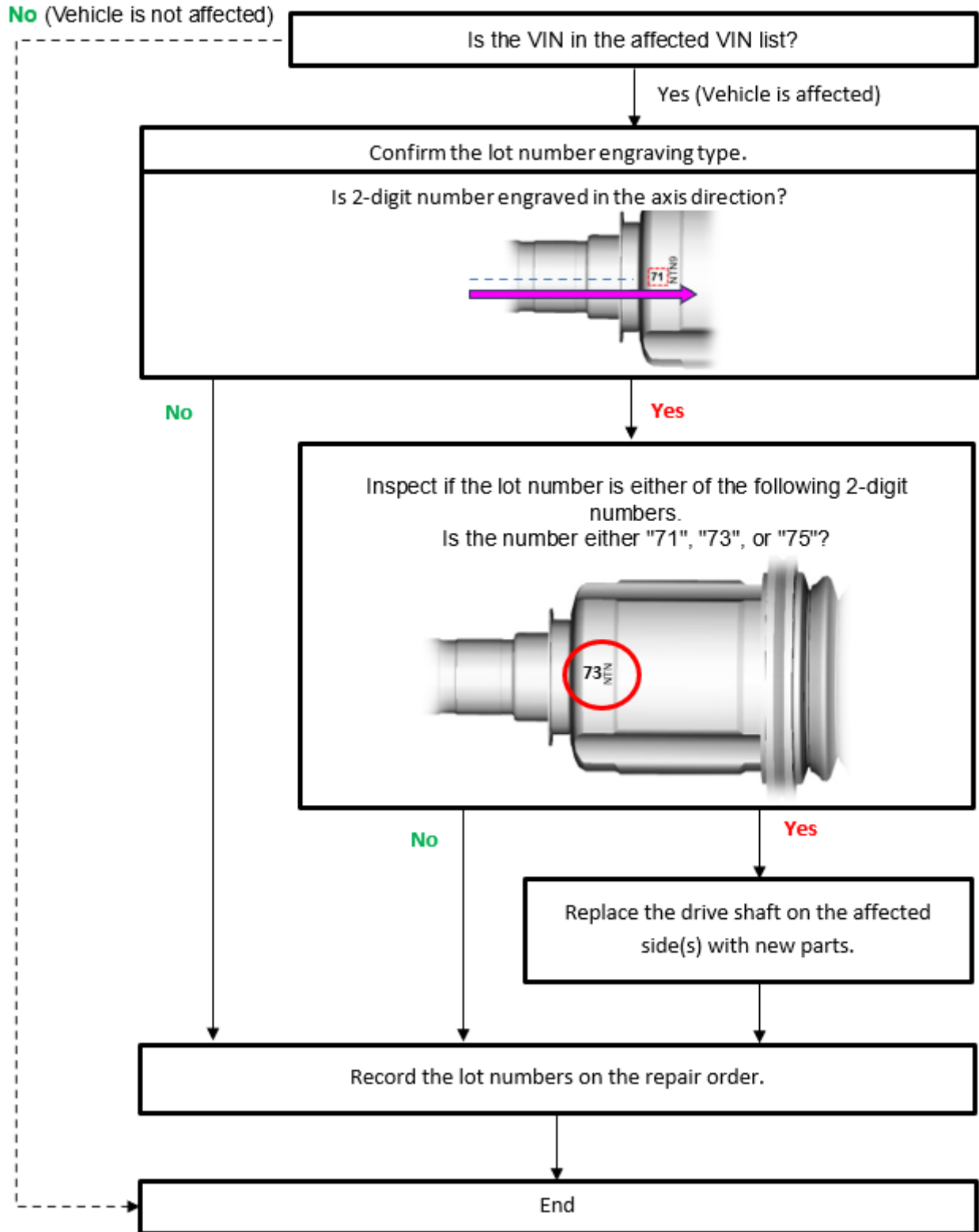

Continued...

SERVICE PROCEDURE INFORMATION:

STEP 1: Lift the vehicle according to the lift manufacturer's instructions.

STEP 2: Rotate the left/right front wheel to find the 2-Line engraving located on both the left and right outer race portions of the inner drive shaft joints.

CAUTIONS:

- There are three engravings on the drive shaft outer race. One is the lot number, and the others are NOT lot numbers. The lot number engraving is shown in the images below.
- SLOWLY rotate the wheel to find the lot number. Remove and dust and/or dirt using a clean cloth to make the numbers more visible. A flashlight will also aid in the reading.

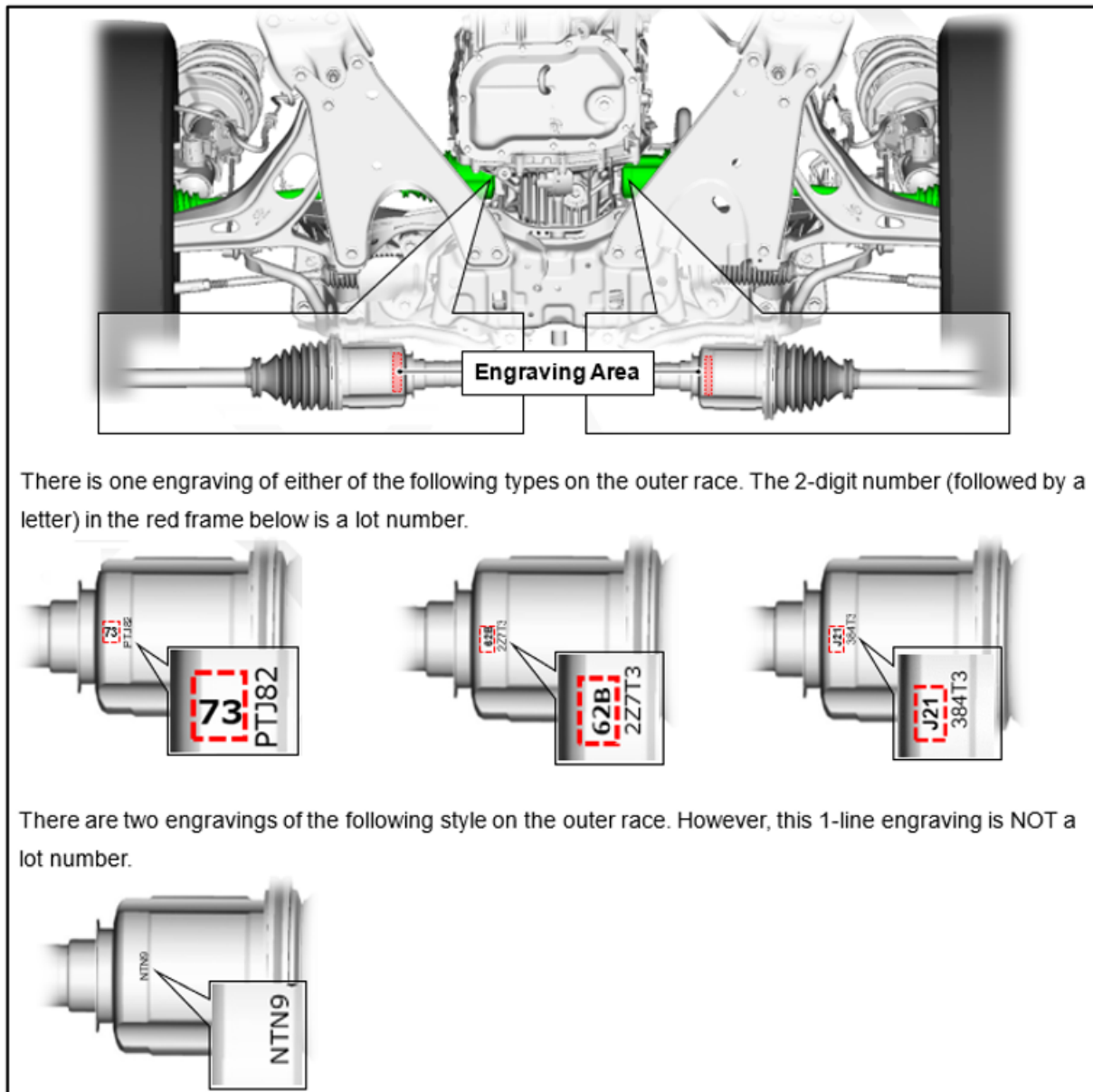

Continued...

STEP 3: Confirm the lot number engraving type and read the lot number. See the tables below for further detail.

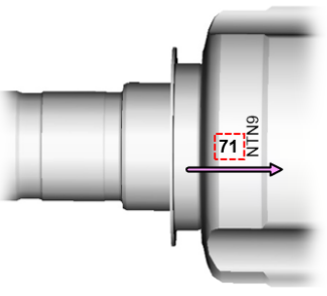
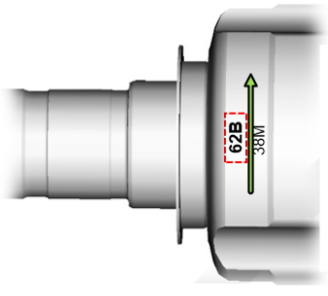
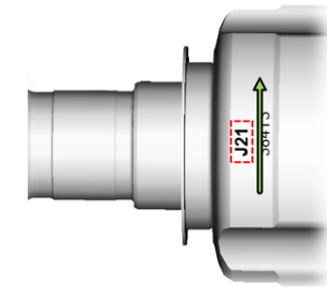
Engraving Type 1	Engraving Type 2	Engraving Type 3
2-digit number is engraved in the axis direction.	3 digit-character starting with a number is engraved in the circumferential direction.	3 digit-character starting with a letter is engraved in the circumferential direction.
		
Results		
Engraving style 1	Refer to the table below for further details.	
Engraving style 2 or 3	The drive shaft is a good part. Record and include the lot number to the repair order.	

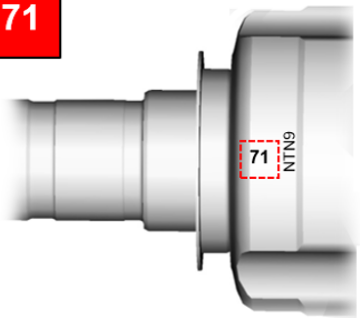
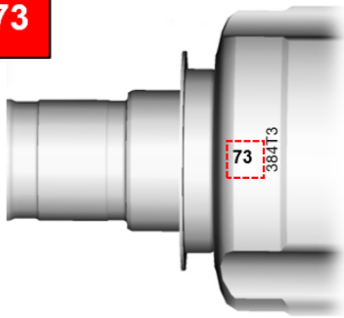
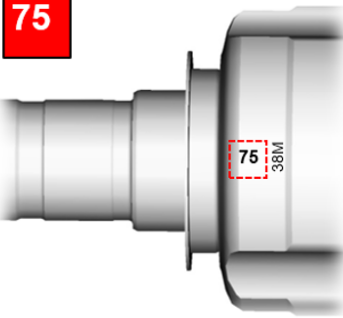
71		73		75	
Results					
71, 73 or 75		The drive shaft is a defective part. Replace the affected front drive shaft with new parts.			
Other 2-digit numbers		The drive shaft is a good part. Record and attach the lot number to the repair order.			

STEP 4: Do any of the drive shafts require replacement?

YES: Review the additional service procedure tips listed below. Replace the affected drive shaft as per the applicable Service Manual. Refer to STIS: [Driveline/Axle > PROPELLERSHAFT / DRIVE SHAFT / AXLE > Front Drive Shaft](#)

NO: The procedure is complete. Record the lot numbers and include them in the repair order notes.

Continued...

DRIVE SHAFT REPLACEMENT SERVICE PROCEDURE TIPS:

TIP 1: The Service Manual states it is necessary to disconnect the battery terminal. This step can be avoided if the temperature of the Center Information Display (CID), Multi-Function Display (MFD), and the Combination Meter is 41°F (5°C) or higher. Performing the steps below can avoid battery disconnection.

1. Turn the ignition switch to the “OFF” position.
2. Start the engine.
3. Turn the ignition switch to the “OFF” position.
4. Wait for at least five minutes.

IMPORTANT: This procedure is only to be used for this campaign. Always perform battery disconnection when requested by the applicable Service Manual for other procedures.

TIP 2: The applicable Service Manual may state it is necessary to perform the “VDC Sensor Midpoint Setting Mode” and/or “Lane Keep Assist Learning Value Clearing” procedures. Front drive shaft replacement does not affect the wheel alignment therefore it is not necessary to perform these procedures for this campaign.

TIP 3: When disconnecting the lower control arm, covering the ball joint boot with a clean cloth can protect the boot from possible damage.

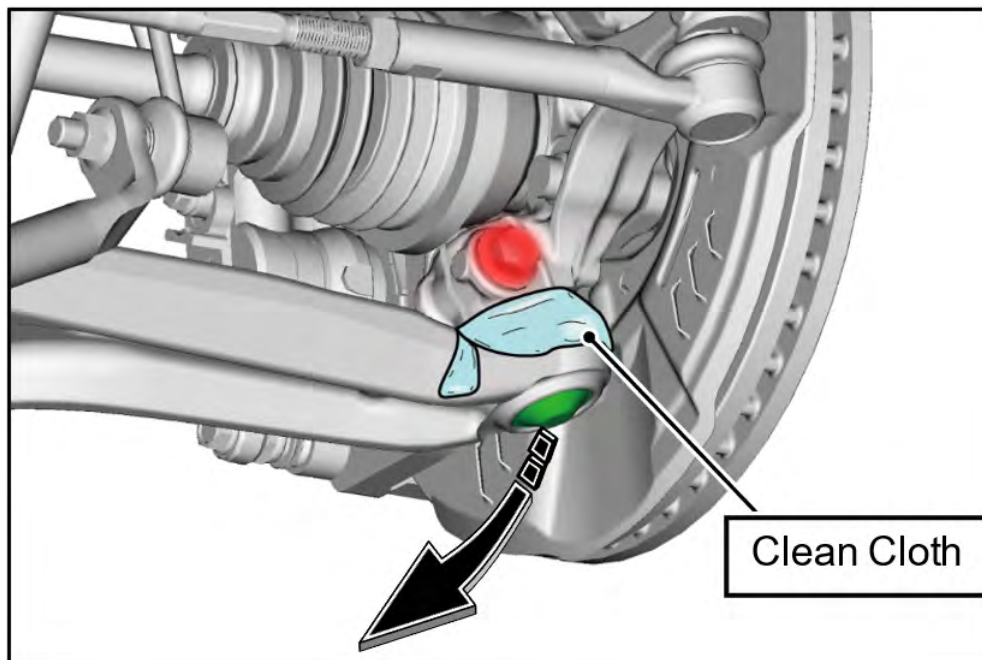

Continued...

TIP 3: When removing the front differential side seal(s), place the removal tool such as a tire lever or suitable pry bar on the back side of the seal lip and remove. A wooden block can also be used to assist the leverage of the removal tool and prevent damage to the differential case.

CAUTION: DO NOT hit or strike the removal tool. Doing so may cause damage to the sealing surface.

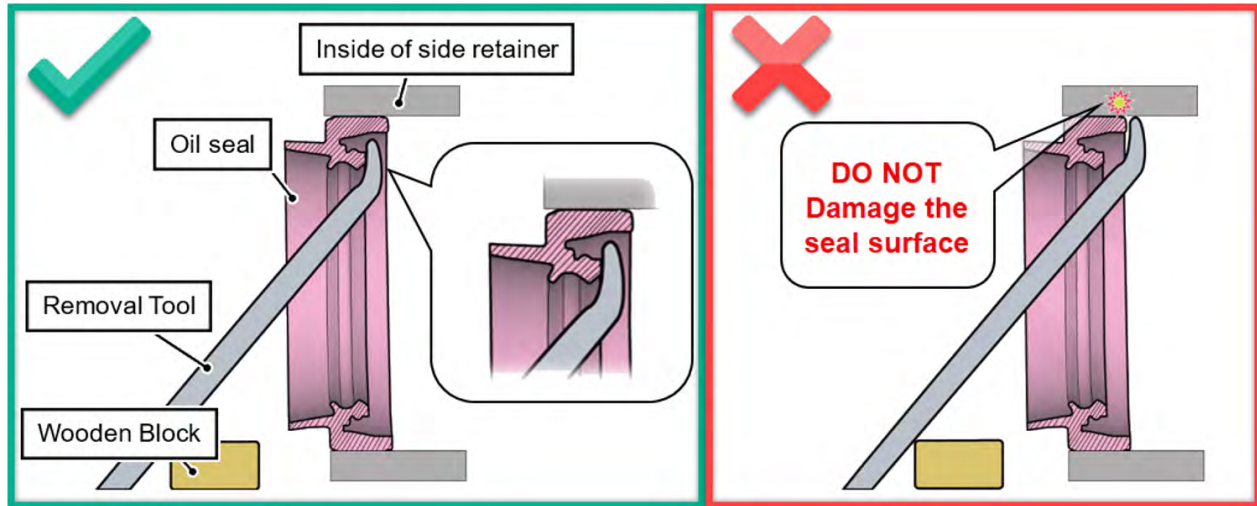

CAUTION: The left and right differential side seals are left and right side specific. There are L and R markings located on the seals indicating left and right installation position.

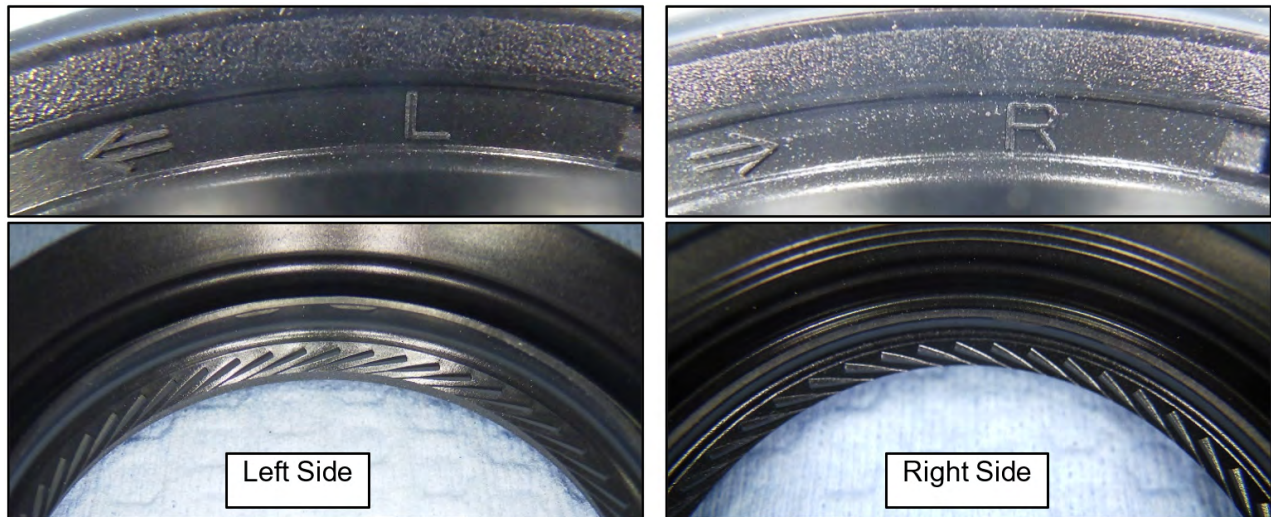

TIP 4: The Service Manual states it is necessary drain and refill the front differential gear oil during the front drive shaft replacement. The front differential oil does **NOT** require replacement for this procedure. Any fluid loss can be rectified by adding new gear oil when required.

Continued...

SERVICE PROGRAM IDENTIFICATION LABEL:

Type or print the necessary information on a Campaign Identification Label. The completed label should be attached to the vehicle’s upper radiator support. Additional labels are available through normal parts ordering channels. The part number is **MSA6P1302**, which comes as one sheet of 20 labels.

Part Number	Applicability	Description	Order Quantity
MSA6P1302	All Models	Campaign Completion Labels (contains one sheet of 20 labels)	1

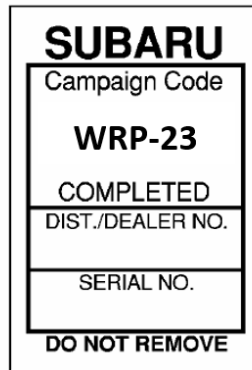

CLAIM REIMBURSEMENT AND ENTRY PROCEDURES:

Credit to perform this recall will be based on properly completed repair order information. Retailers may submit claims through Subarunet.com. Lott Numbers inspected and installed are required for claim entry.

Impreza			
Labor Description	Labor Operation #	Labor Time	Fail Code
BOTH FRONT DRIVESHAFT INSPECTION	A121-300	0.3	WRP-23
BOTH FRONT DRIVESHAFT INSPECTION & RH AXLE R&R	A121-301	1.0	
BOTH FRONT DRIVESHAFT INSPECTION & LH AXLE R&R	A121-302	1.5	
BOTH FRONT DRIVESHAFT INSPECTION & BOTH AXLE R&R	A121-303	1.8	

Forester			
Labor Description	Labor Operation #	Labor Time	Fail Code
BOTH FRONT DRIVESHAFT INSPECTION	A121-300	0.3	WRP-23
BOTH FRONT DRIVESHAFT INSPECTION & RH AXLE R&R	A121-301	1.0	
BOTH FRONT DRIVESHAFT INSPECTION & LH AXLE R&R	A121-302	1.5	
BOTH FRONT DRIVESHAFT INSPECTION & BOTH AXLE R&R	A121-303	1.8	

Crosstrek			
Labor Description	Labor Operation #	Labor Time	Fail Code
BOTH FRONT DRIVESHAFT INSPECTION	A121-300	0.3	WRP-23
BOTH FRONT DRIVESHAFT INSPECTION & RH AXLE R&R	A121-301	1.1	
BOTH FRONT DRIVESHAFT INSPECTION & LH AXLE R&R	A121-302	1.6	
BOTH FRONT DRIVESHAFT INSPECTION & BOTH AXLE R&R	A121-303	1.9	

Continued...

WRX			
Labor Description	Labor Operation #	Labor Time	Fail Code
BOTH FRONT DRIVESHAFT INSPECTION	A121-300	0.3	WRP-23
BOTH FRONT DRIVESHAFT INSPECTION & RH AXLE R&R	A121-301	0.9	
BOTH FRONT DRIVESHAFT INSPECTION & LH AXLE R&R	A121-302	1.1	
BOTH FRONT DRIVESHAFT INSPECTION & BOTH AXLE R&R	A121-303	1.4	

IMPORTANT REMINDERS:

- SOA strongly discourages the printing and/or local storage of service information as previously released information and electronic publications may be updated at any time.
- Always check for any open recalls or campaigns anytime a vehicle is in for servicing.
- Always refer to STIS for the latest service information before performing any repairs.

IMPORTANT SAFETY RECALL

This notice applies to the VIN identified in the address section printed below



PO Box 9103
Camden, NJ 08101-9877
844-373-6614
www.subaru.com

**Subaru Safety Recall WRP-23
NHTSA ID 23V-754
January 2024**

Dear Subaru Owner:

This notice is sent to you in accordance with the National Traffic and Motor Vehicle Safety Act.

SUBARU OF AMERICA, INC. has decided that a defect, which relates to motor vehicle safety, exists in certain 2023 model year WRX vehicles, certain 2024 model year Crosstrek and Impreza vehicles, and certain 2023-2024 model year Forester vehicles.

You received this notice because our records indicate that you currently own one of these vehicles.

DESCRIPTION OF THE DEFECT AND SAFETY RISK

The front drive shaft assemblies on your vehicle may have an outer race that could crack, due to improper cooling during the manufacturing process.

Over time, a cracked outer race could break, potentially resulting in loss of motive power. Additionally, if the outer race breaks, the vehicle may roll when parked if the parking brake is not applied. Both conditions increase the risk of a crash.

WHAT SUBARU WILL DO

Subaru will inspect the left-hand and right-hand front drive shafts and where necessary, replace them with a new one at no cost to you.

WHAT YOU SHOULD DO

Please contact your Subaru retailer (dealer) immediately for an appointment to have this repair performed, at no cost to you.

HOW LONG WILL THE REPAIR TAKE?

The time to inspect the lot numbers is less than 20 minutes. If one or both driveshafts need to be replaced, the time required to perform this repair will take up to two hours. However, it may be necessary to leave your vehicle for a longer period of time on the day of your scheduled appointment to allow your Subaru retailer flexibility in scheduling.

OWNER INFORMATION

Government regulations require that recall notifications be sent to the last known owner of record. That information is based primarily on state registration and title data. If you are a lessor of this vehicle, federal regulations require you to forward this notice to your lessee within ten days.

If you have moved or sold your vehicle, please go to <https://www.subaru.com/support/customer-support.html> to send us your information.

IF YOU HAVE PREVIOUSLY PAID FOR A REPAIR

If you have already paid for repairs associated with this condition, you may be eligible for reimbursement. Reimbursement consideration will be based on the amount an authorized Subaru retailer in your area would charge for the same repair.

Please send the original service repair order, which has the name of the repair facility, date of repair, mileage at the time of repair, complete 17-digit vehicle identification number (VIN), and your name, with correct mailing address and telephone number to the address listed below.

Subaru of America, Inc.

Customer Advocacy Department, Attention: WRP-23 Recall

P.O. Box 9103, Camden, NJ 08101-9877

Please send original receipts only and retain a photocopy for your records. Please be assured that we will attempt to process your reimbursement request as quickly as possible, but it may take up to 60 days for this process to be completed.

IF YOU NEED FURTHER ASSISTANCE:

To locate the nearest Subaru retailer, you can access our website at www.subaru.com and select 'Find a Retailer.'

For additional information, please go to: <http://www.wrp23.service-campaign.com>.

If you need additional assistance, please contact us directly:

- By e-mail: Go to www.subaru.com and select "Customer Support"
- By telephone: 1-844-373-6614
Monday through Friday between 8:00 a.m. and 7:00 p.m. ET
- By U.S. Postal mail: Write us at Subaru of America, Inc.
Attn: Customer Advocacy Department
P.O. Box 9103, Camden, NJ 08101-9877

To subscribe to the NHTSA Recall Notification email System, please go to: <https://www-odi.nhtsa.dot.gov/nhtsa/subscriptions>.

Please contact us immediately if the Subaru retailer fails or is unable to make the necessary repairs free of charge.

You may also contact the Administrator, National Highway Traffic Safety Administration (NHTSA), 1200 New Jersey Ave., SE, Washington, DC 20590 or call the toll-free Vehicle Safety Hotline at 1-888-327-4236 (TTY: 1-800-424-9153) or go to <http://www.NHTSA.gov> if you believe the Subaru retailer has failed or is unable to remedy your vehicle without charge within a reasonable amount of time.

Your continued satisfaction with your Subaru is important to us. Please understand that we have taken this action in the interest of your safety and your vehicle's proper operation. We sincerely apologize for any inconvenience this matter may cause and urge you to schedule an appointment as soon as possible.

Sincerely,

Subaru of America, Inc.

A subsidiary of SUBARU CORPORATION