

ATTENTION:
 GENERAL MANAGER
 PARTS MANAGER
 CLAIMS PERSONNEL
 SERVICE MANAGER

IMPORTANT - All Service Personnel Should Read and Initial in the boxes provided, right.

© 2022 Subaru of America, Inc. All rights reserved.



QUALITY DRIVEN® SERVICE

PRODUCT CAMPAIGN BULLETIN

APPLICABILITY: 2019-2022MY Ascent

NUMBER: WRL-22R

SUBJECT: PTC Heater Ground Bolt

DATE: 12/12/22

NHTSA: 22V-907

REVISED: 01/24/23

Subaru of America, Inc. (Subaru) is initiating a new safety recall for certain 2019-2022 model year Ascent vehicles.

DESCRIPTION OF THE DEFECT AND SAFETY RISK

The ground bolt that secures the ground terminal of the Positive Temperature Coefficient (PTC) heater may have been improperly fastened during vehicle production. This potential condition may result in the melting of the ground terminal and surrounding components when the PTC heater is in operation, increasing the risk of a fire.

REMEDY

For all potentially affected vehicles, Subaru retailers will replace the PTC heater ground bolts and, if necessary, replace the ground wire harness and connector holder at no cost to the customer.

- As a precautionary measure, it is highly recommended that owners park their vehicle away from any garage, car port or other structure until this repair is completed.
- Additionally, owners should never leave the vehicle unattended while the engine is running until this repair is completed.
- If an owner notices or smells melting plastic or smoke coming from the dash or driver’s footwell area, the ignition should be placed in the “off” position and the vehicle should not be operated. If this occurs, the owner should immediately contact Subaru’s Roadside Assistance or the nearest Subaru retailer for assistance.

CAUTION: VEHICLE SERVICING PERFORMED BY UNTRAINED PERSONS COULD RESULT IN SERIOUS INJURY TO THOSE PERSONS OR TO OTHERS.

Subaru Service Bulletins are intended for use by professional technicians ONLY. They are written to inform those technicians of conditions that may occur in some vehicles, or to provide information that could assist in the proper servicing of the vehicle. Properly trained technicians have the equipment, tools, safety instructions, and know-how to do the job correctly and safely. If a condition is described, DO NOT assume that this Service Bulletin applies to your vehicle, or that your vehicle will have that condition.

Subaru of America, Inc. is ISO 14001 Compliant

ISO 14001 is the international standard for excellence in Environmental Management Systems. Please recycle or dispose of automotive products in a manner that is friendly to our environment and in accordance with all local, state and federal laws and regulations.

Continued...

AFFECTED VEHICLES

A total of 271,694 U.S. vehicles will be included in this recall as listed below. Not all vehicles in the production range listed above are affected by this recall. Coverage must be confirmed by using the Vehicle Coverage Inquiry function on subarunet.com prior to repair. This information is now available.

Model Year	Carline	Production Date Range
2019-2022	Ascent	February 23, 2018 – April 28, 2022

The VIN status for this recall will display as ‘Open-Limited Parts Available’ until the owner notification letters are mailed, at which time the status will be updated to ‘Open.’ Repairs can begin prior to the owner notification.

RETAILER RESPONSIBILITY

Please be advised that it is a violation of Federal law for a dealer to deliver a new motor vehicle covered by a recall under a sale or lease until the defect is remedied. Therefore, any Authorized Subaru Retailer failing to perform the applicable service procedures to correct all affected vehicles in their inventory prior to the vehicle being placed in service may be subject to civil penalties of up to \$22,423 per violation (i.e., for each vehicle), as provided in 49 CFR §578.6 and will also be in breach of the Subaru Dealer Agreement.

Any vehicles listed in any recall/campaign that are in retailer stock must be:

- Immediately identified
- Tagged or otherwise marked to prevent their delivery or use prior to repair
- Repaired in accordance with the repair procedures outlined in the Product Campaign Bulletin

Retailers are to promptly perform the applicable service procedures, to correct all affected vehicles in their inventory (used, demo & SSLP). Whenever a vehicle subject to this recall is taken into retailer inventory necessary steps should be taken to ensure the recall correction has been made before selling or releasing the vehicle.

OWNER NOTIFICATION

Subaru is in the process of obtaining current vehicle registration data and will notify affected vehicle owners by first class mail within 60 days. Retailers will be advised when owner notification is scheduled.

Continued...

PART INFORMATION:

Up to two kits may be required for this procedure. The bolt kit is required on ALL vehicles. The harness kit is required if the inspection results confirm further **harness** work is required.

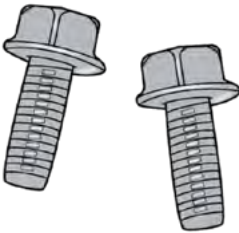

Part Description	Kit Part Number	Qty	Application	Ordering Method
WRL-22 Bolt Kit	SOA635174	1	Required on ALL vehicles	Ordered through PRIME
WRL-22 Harness Kit	SOA635175	1	Required on vehicles needing further harness work after inspection	Currently on HOLD. The PIC team will release the ordered parts when contacted & provided with a valid VIN and QMR number

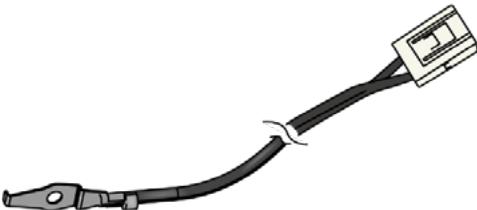
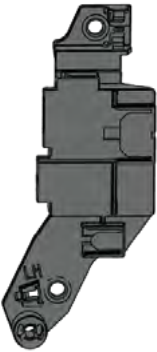
Bolt Kit (SOA635174) Components		
Part Description	Qty	Image
BOLT (Ground Bolt)	2	

Harness Kit (SOA635175) Components		
Part Description	Qty	Image
INST PNL HARN USA (PTC Heater Ground Wire)	1	
CONNECTOR HOLDER LH	1	

Continued...

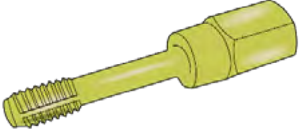
REQUIRED TOOLS:

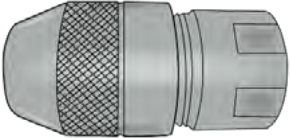
Tool Description	Application	Image
Thread Chaser (M6 x 1.0)	For cleaning the female thread of the ground terminal.	
Tap (M6 x 1.0)	For repairing female thread of the ground terminal.	
Tap Holder	To be used with tap.	

QMR INFORMATION:

The following are required when a harness kit (SOA635175) repair is necessary (arcing or melting found at the ground point):

1. There is a QMR submission requirement should a repair require the harness kit (SOA635175).
 - A TechShare QMR must be issued including photo(s) clearly showing the melting or arcing condition found at the ground point necessitating the repair.
 - Include the VOR parts order number for the related harness kit (SOA635175) in the QMR comments. This will be used to prioritize release of parts as they become available.
2. **ALL** claim submissions for repairs requiring a harness kit (SOA635175) will require attachment of photos to the claim submission documenting the condition found requiring a harness kit repair.

Continued...

COMPONENT DESCRIPTION/CONFIGURATION:

Diagram 1

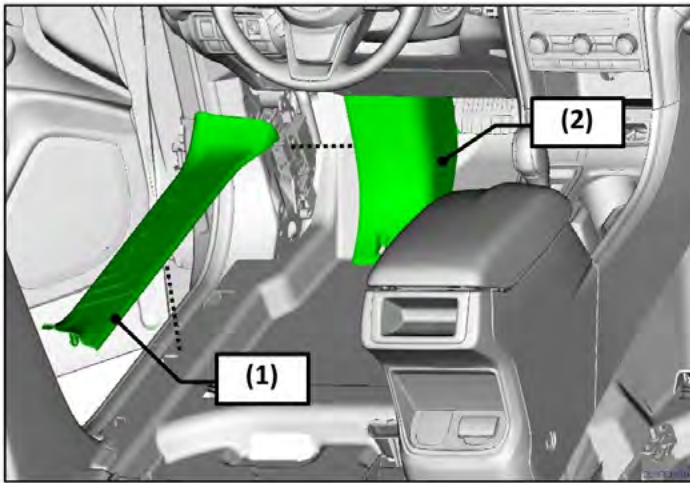

(1) Left rear side sill cover (94060XC110VH)

(2) Left front side sill cover (94060XC01AVH)

(3) Ground bolts

Tightening Torque: 13 N·m

(4) Connector holder

(5) Ground terminal

(6) Ground wire

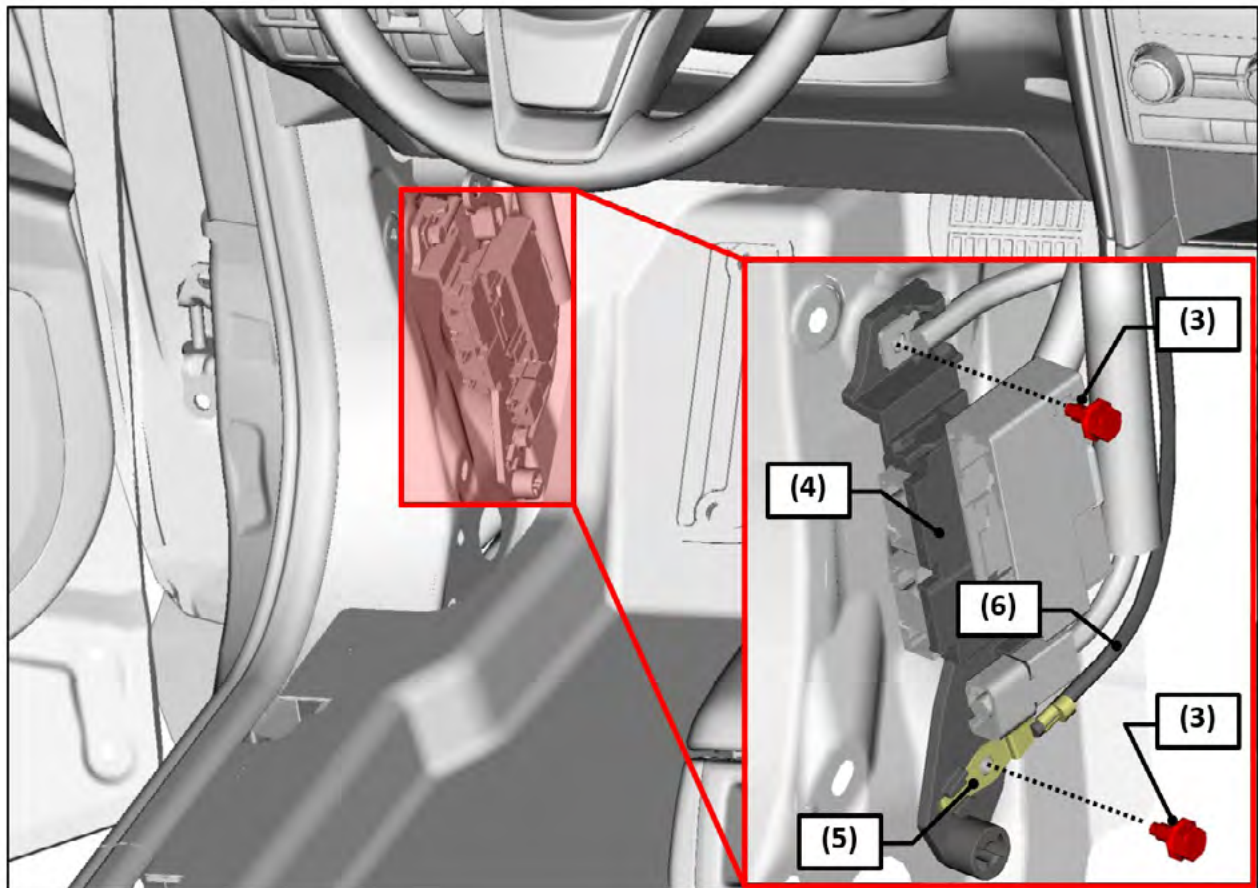

Continued...

Diagram 2

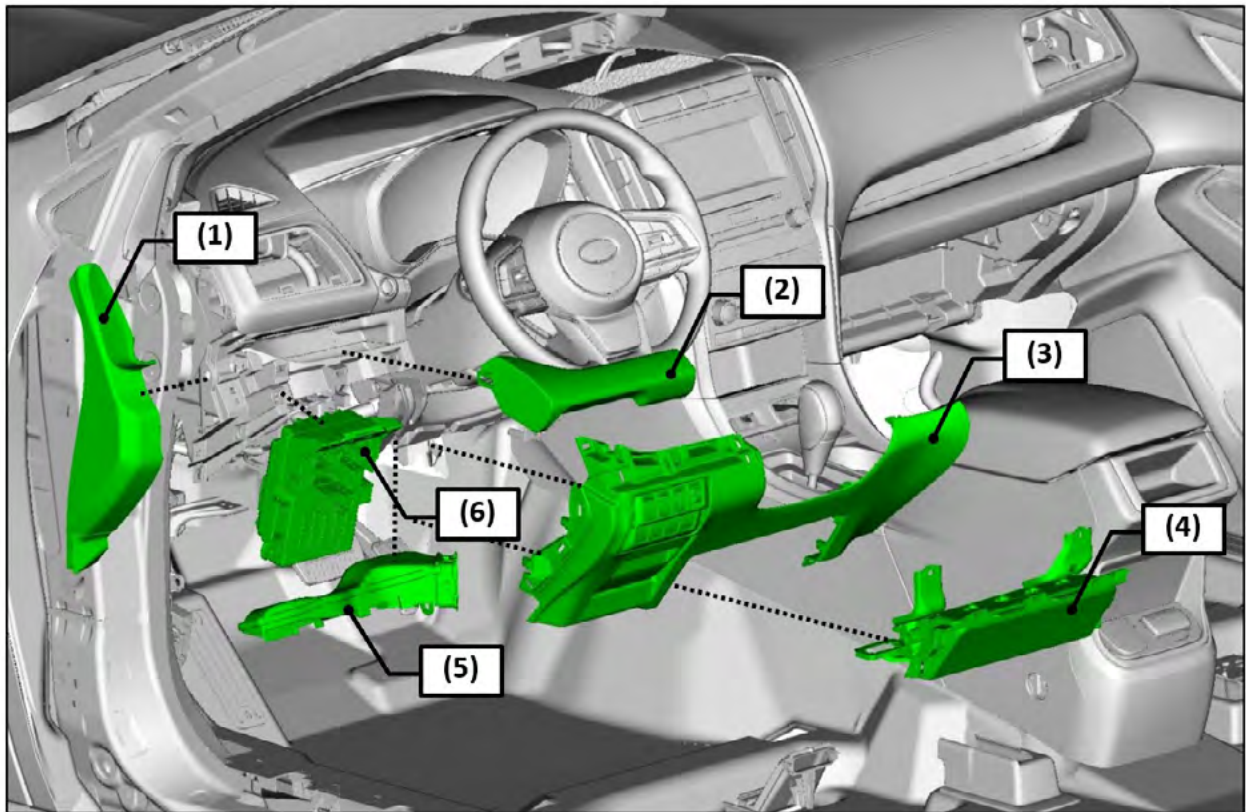

(1) Side lid panel

(2) Ornament panel

(3) Lower cover

(4) Knee airbag module

Tightening Torque : 7.5 N·m

(5) Heater duct

(6) Fuse box

Tightening Torque : 7.5 N·m

Continued...

Diagram 3

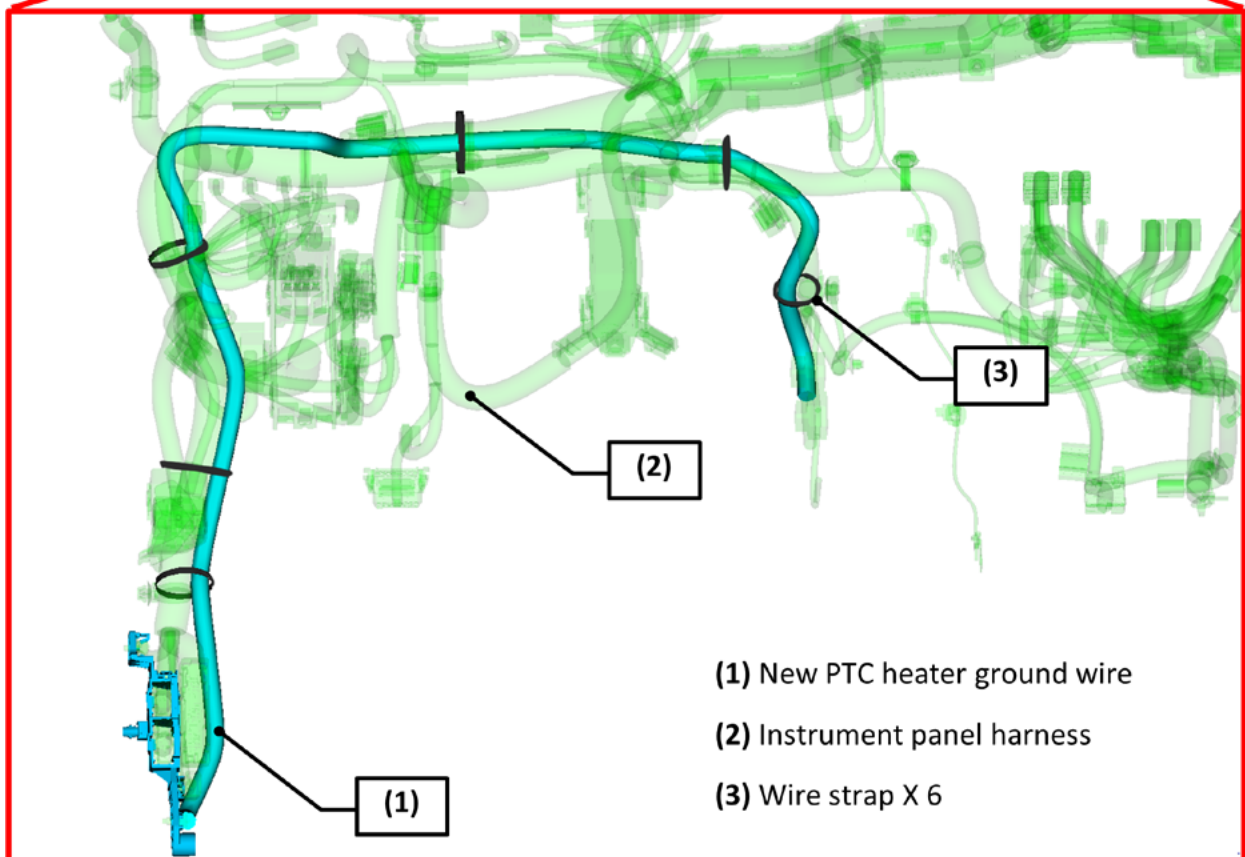
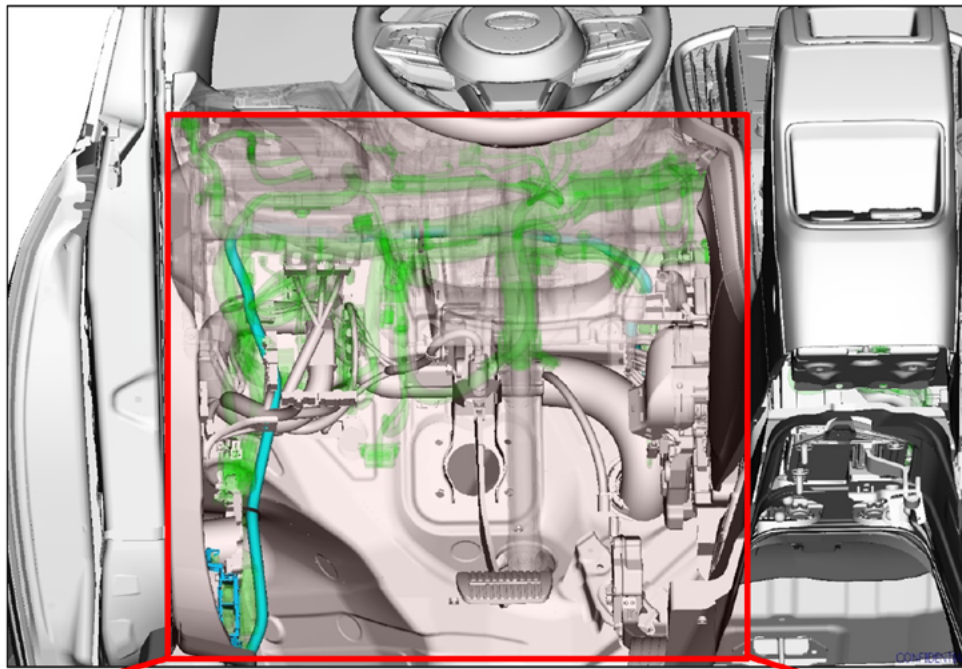

Continued...

Service Procedure / Flowchart:

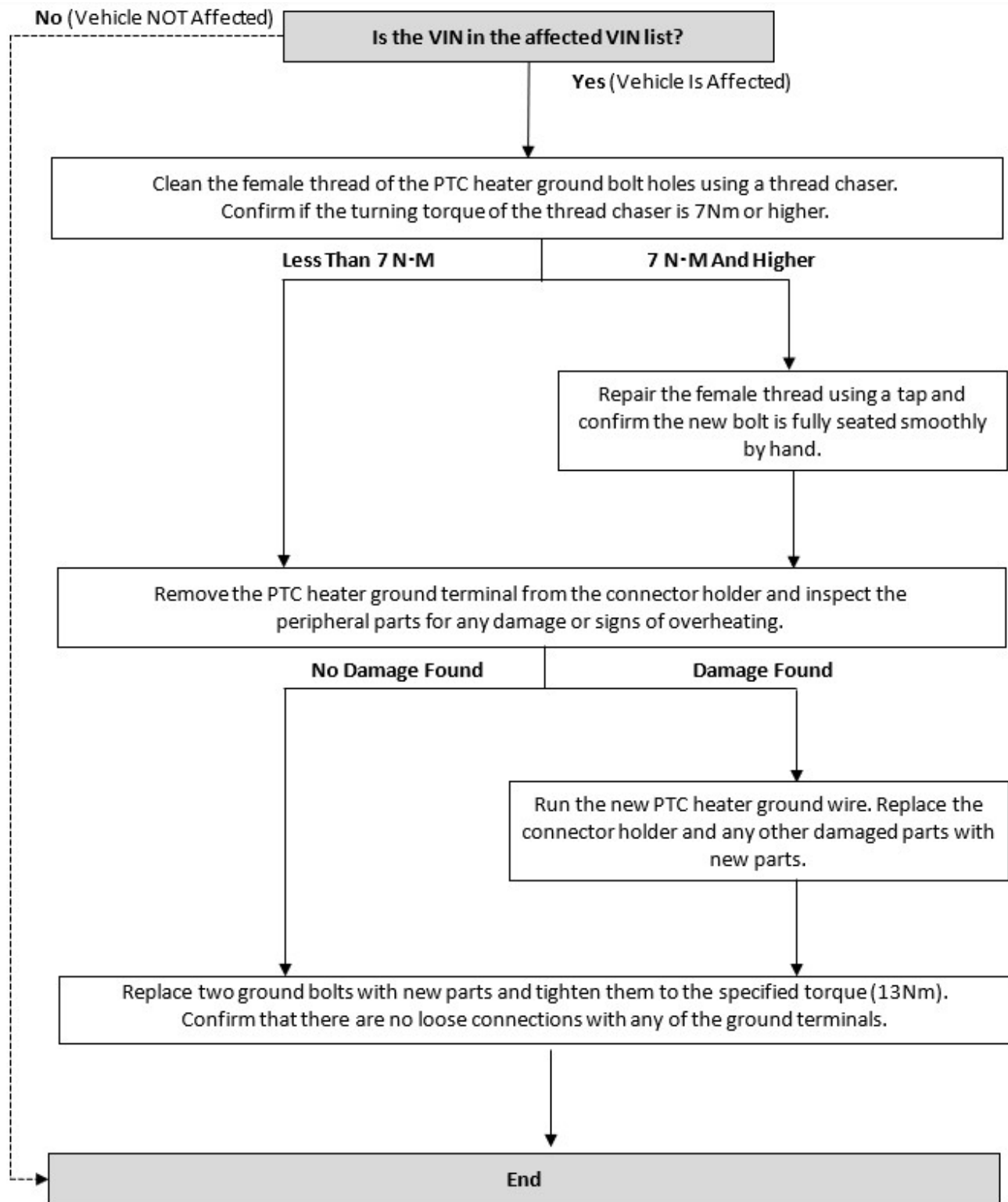

Continued...

SERVICE PROCEDURE / INFORMATION:

REMINDER: Customer satisfaction and retention starts with performing quality repairs.

STEP 1: Refer to the applicable Service Manual and review: General Description > Repair Contents > Action required before & after Battery Disconnect. Additionally, record any stored seat position(s) before proceeding. Relearn any seat position memory after work is complete. If the power rear gate (PRG) height has been customized, that position must also be noted and relearned.

STEP 2: CAREFULLY disconnect the ground terminal from the battery sensor.

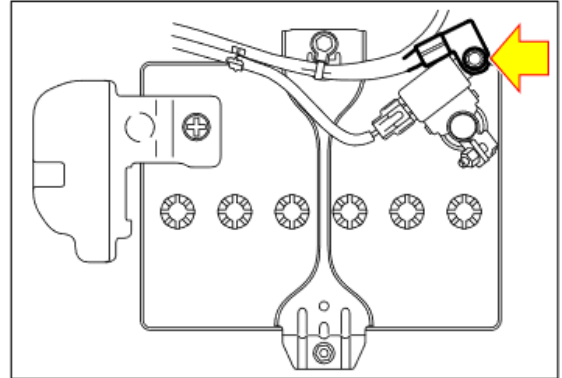

STEP 3: Remove the mounting nut securing the left front side sill cover. CAREFULLY detach the front section of the left rear side sill cover. While holding the front section, use your other hand to detach and remove the left front side sill cover.



CAUTION: ALWAYS remove the cover when it is or has reached room temperature. Any attempts of removal in cold ambient temperatures may result in unwanted breakage DO NOT use excessive force when pulling the cover upward. This may cause damage to the cover.

Continued...

STEP 4: Disconnect all electrical connections from the connector holder.

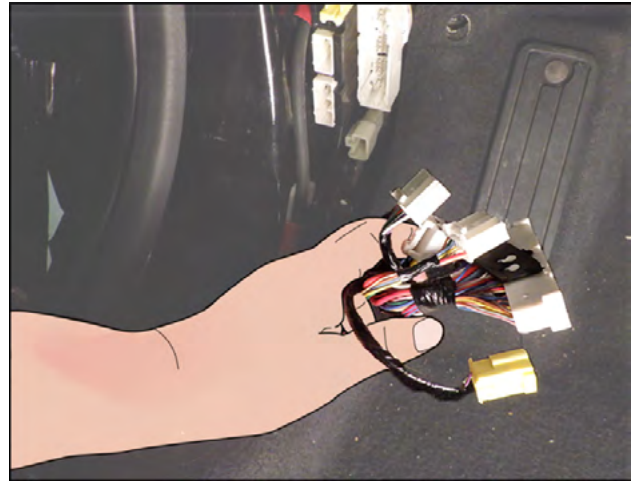

STEP 5: Remove the two heater ground bolts.

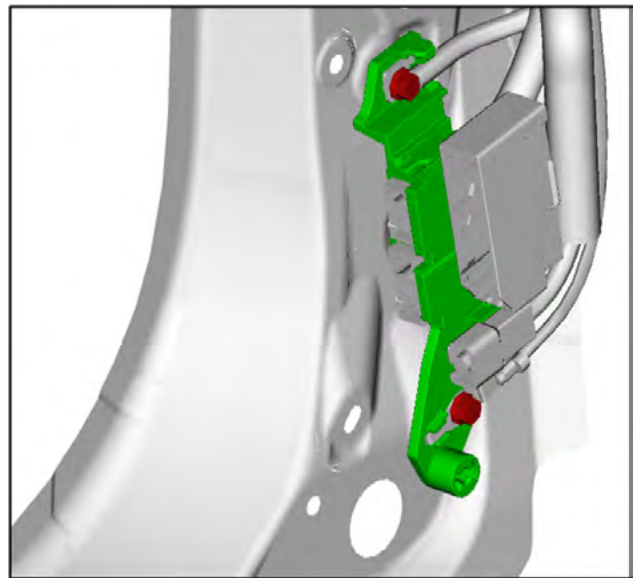

STEP 6: Release the connector holder cover mounting clip security tabs.

CAUTION: To prevent any damage, **DO NOT** attempt to remove the connector holder **WITHOUT** releasing the security tabs first.

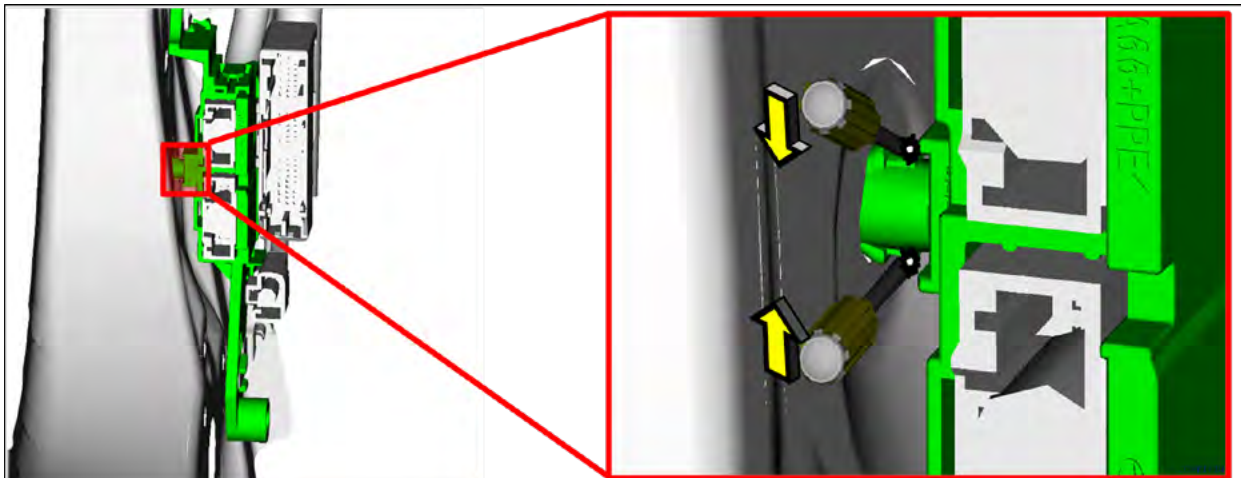

Continued...

STEP 7: Move the connector holder aside to allow room for workspace.

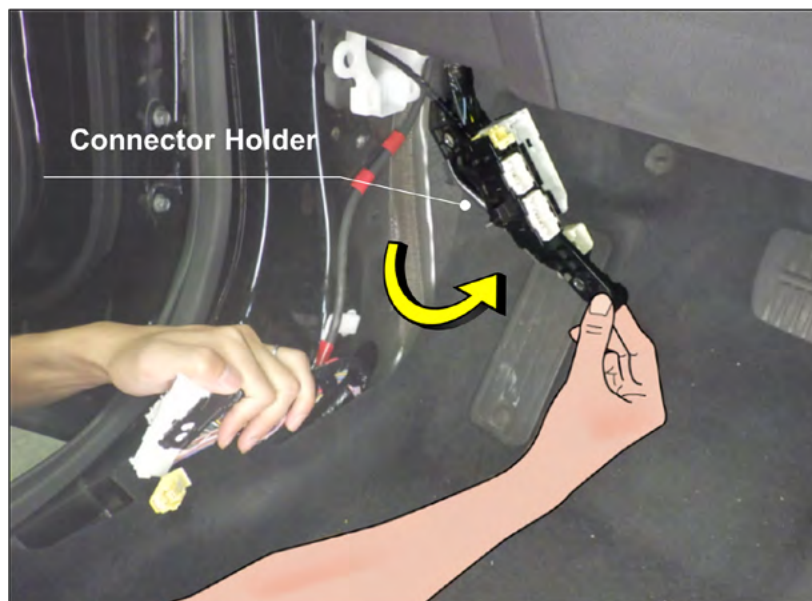

STEP 8: Thread the thread chaser into both of the ground bolt holes. Use a torque wrench to turn the thread chaser. If the turning torque is 7Nm or higher, clean the threads with a tap and recheck the turning torque. Once the turning torque is less than 7Nm, continue to the next STEP.

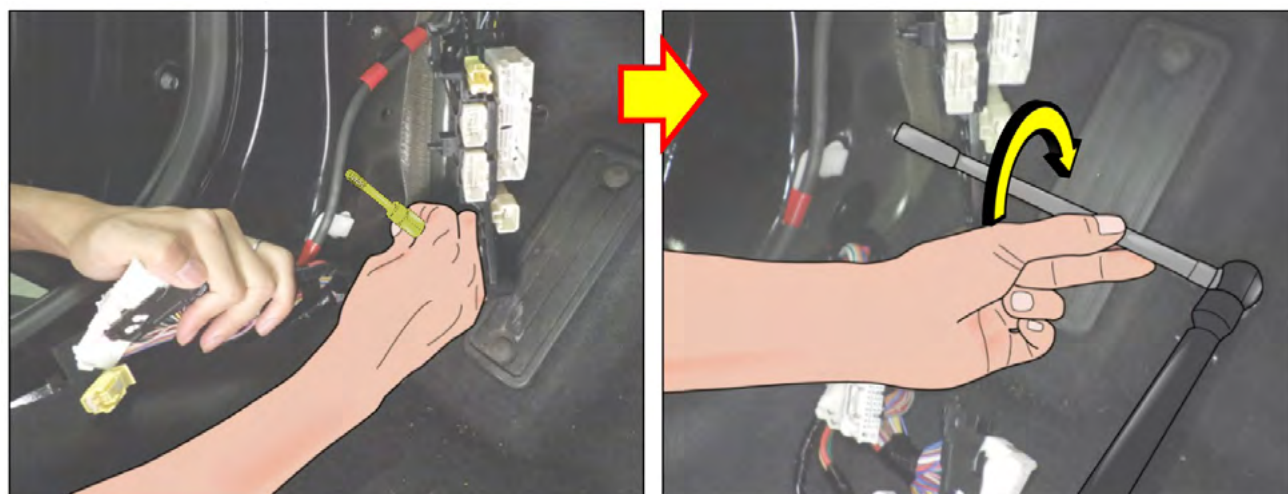

Continued...

STEP 9: Using a small flat head screwdriver, release the holding claw on the back of the connector holder. With the claw released, remove the PTC heater ground terminal from the connector holder.

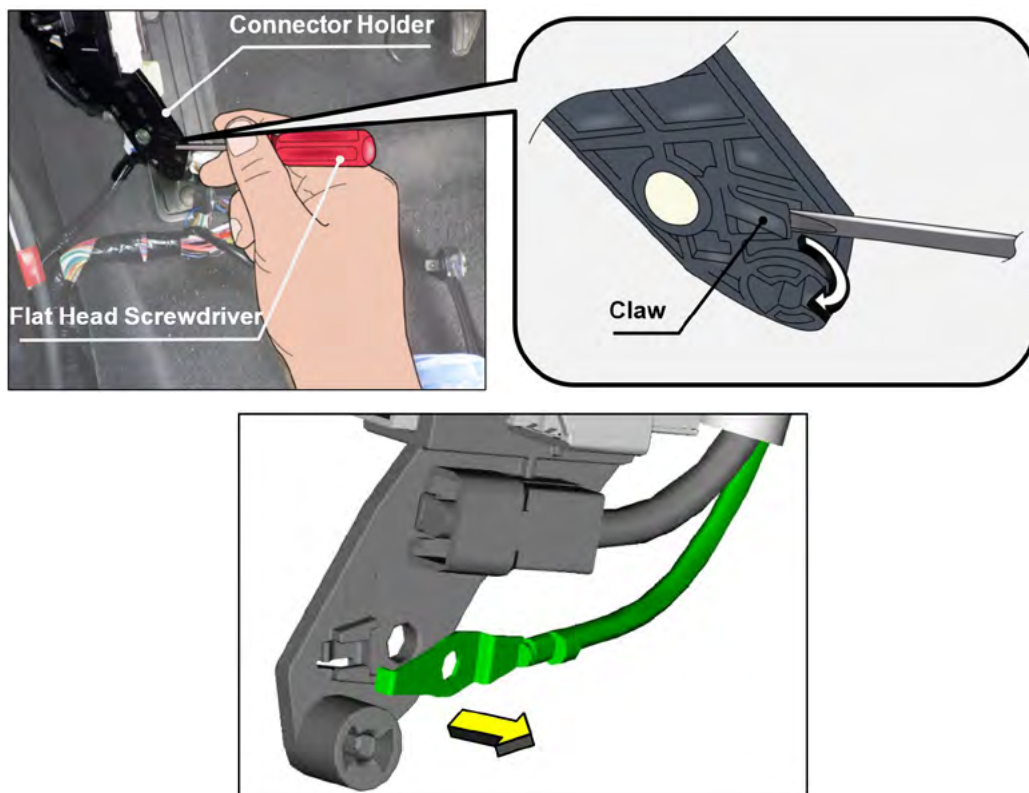

STEP 10: CAREFULLY inspect the PTC heater ground terminal and peripheral parts for any damage. See the example images of overheat damage below.

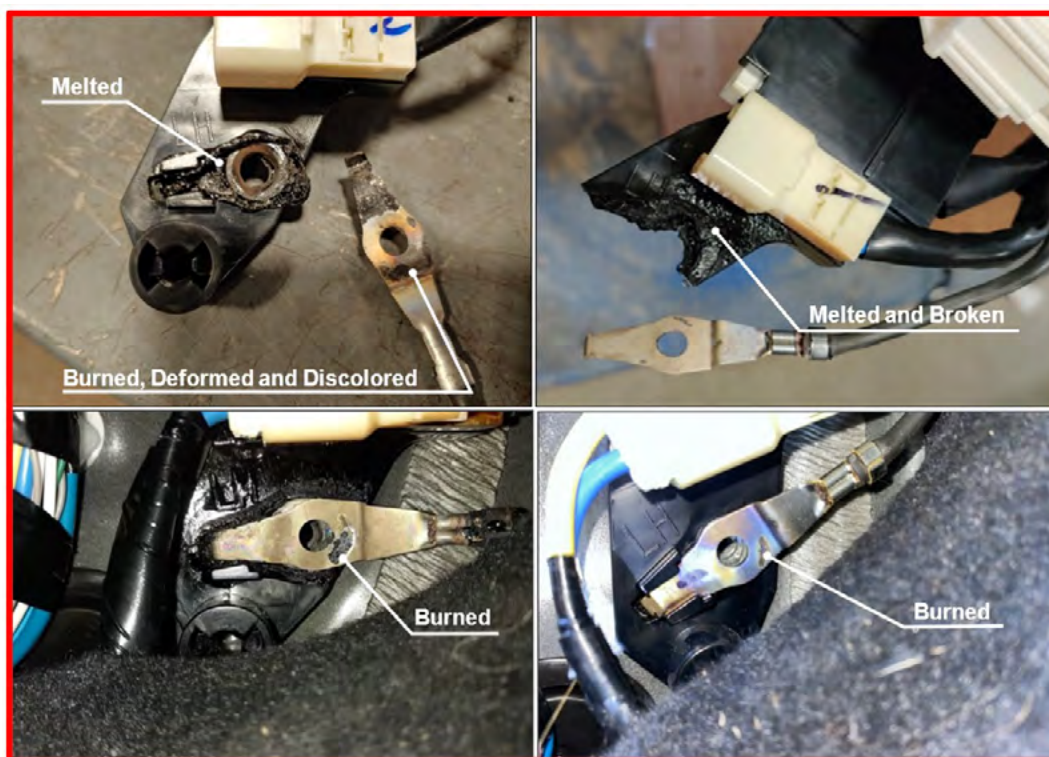

IMPORTANT: If any damage is found, a QMR will be required with detailed photos of the damage attached and the repair parts order information noted in the comments section.

Continued...

STEP 11: Has any damage been found with the PTC heater ground terminal and/or the peripheral parts?

YES – Proceed to STEP 13.

NO – Proceed to STEPS 25, 26, & 27. Then proceed to STEP 33.

STEP 12: Pull the front left side cover in the horizontal direction to release the holding claws. Once released remove the cover.

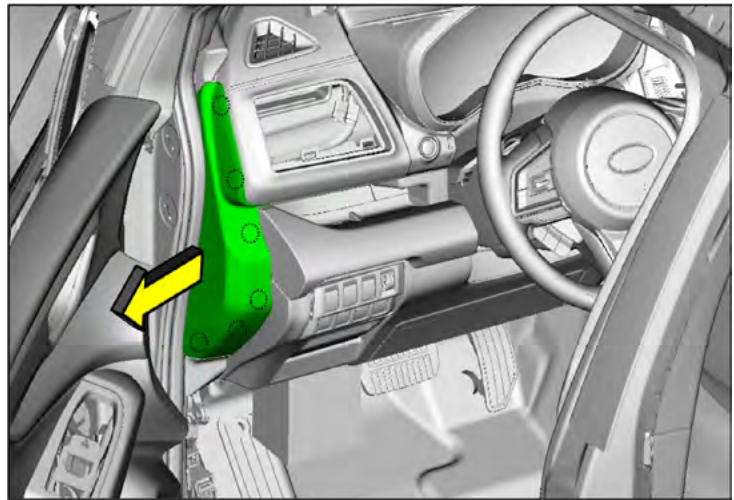

STEP 13: CAREFULLY pull the trim panel toward the rear of the vehicle to release the mounting claws. Once released, remove the panel.

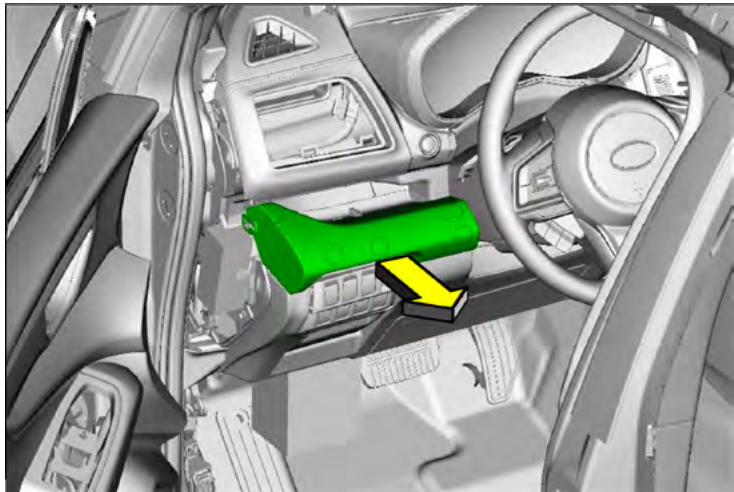

STEP 14: Remove the mounting screw and pull the lower cover toward the rear of the vehicle to release the mounting clips. Once released, disconnect all electrical connections and remove the panel.



Continued...

STEP 15: Disconnect the data link connector. Disconnect the knee airbag module connector. **CAREFULLY** remove the knee airbag module.

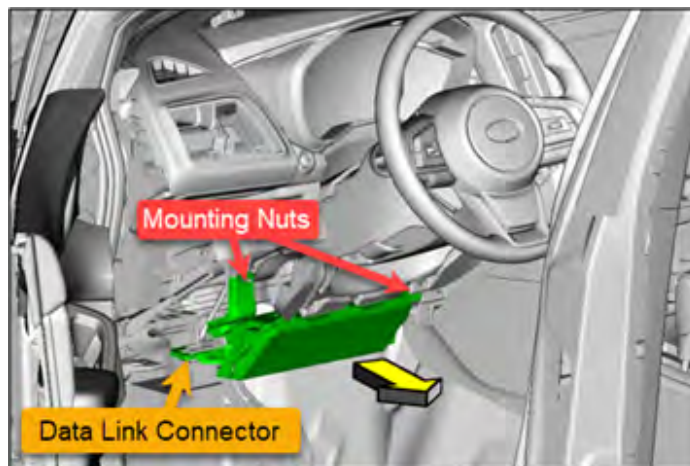

STEP 16: Remove the mounting screw. Release the mounting claws. Remove the duct by pulling in the direction of the left front door.

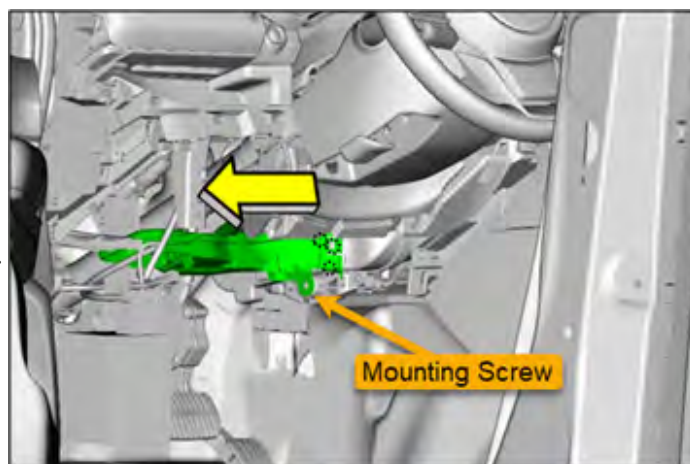

STEP 17: Disconnect the electrical connections at the front of the fuse box. Remove the mounting nuts and screw. Move the fuse box toward the floor to allow for workspace.

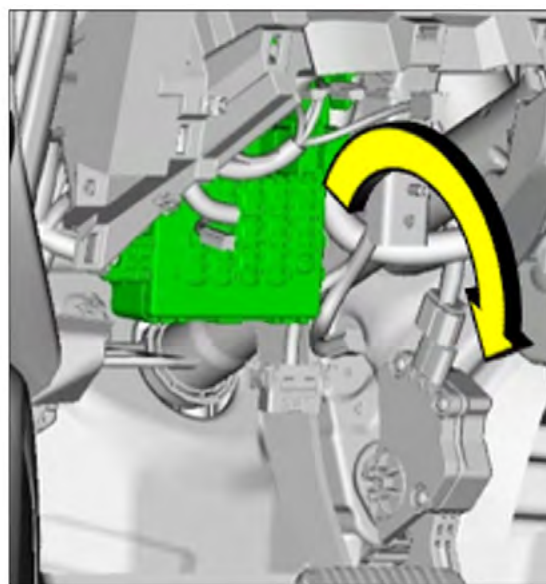
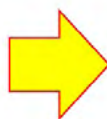
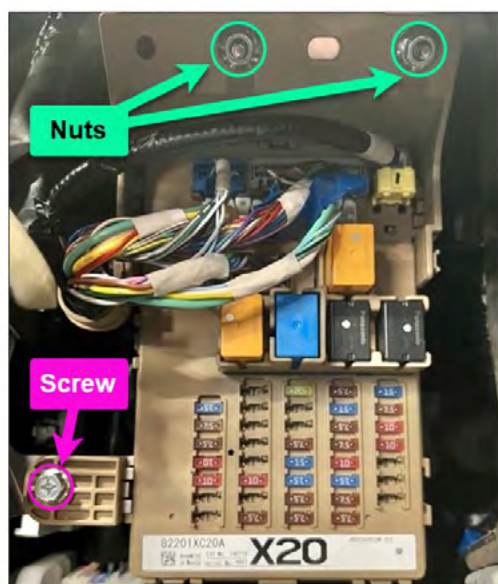

Continued...

STEP 18: Using needle nose pliers, pinch the claw of the connector holder and remove the ground terminal.

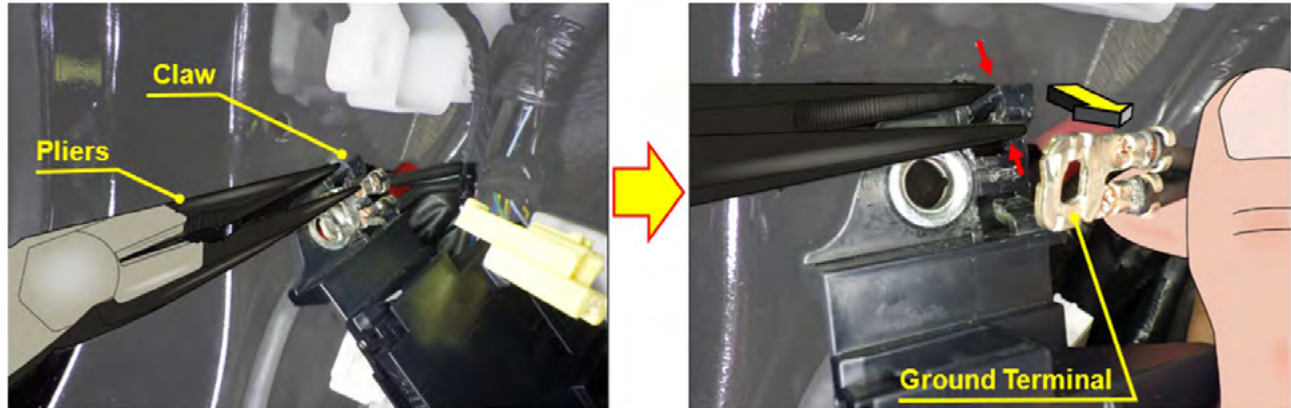

STEP 19: Release the locking tab using a flathead screwdriver. Disconnect all electrical connections and remove the connector holder.

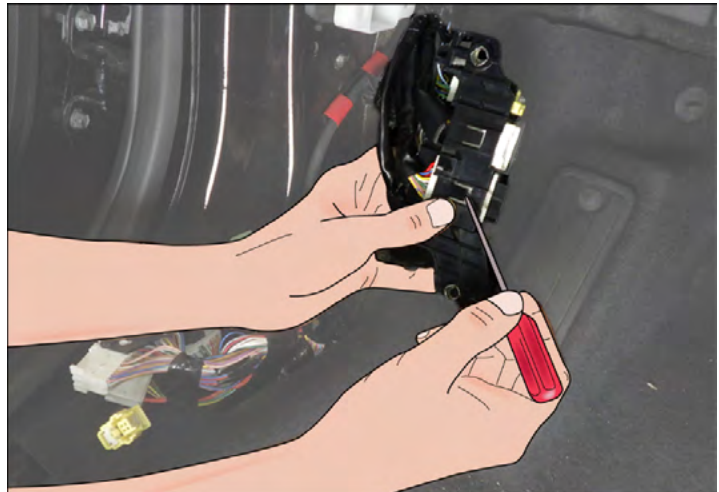

STEP 20: Install the new connector holder supplied in harness kit (SOA635175). Connect all the electrical connections in the reverse order of disassembly. Secure the connector holder to the vehicle body with the mounting clip.

CAUTION: DO NOT install the mounting bolts at this time.

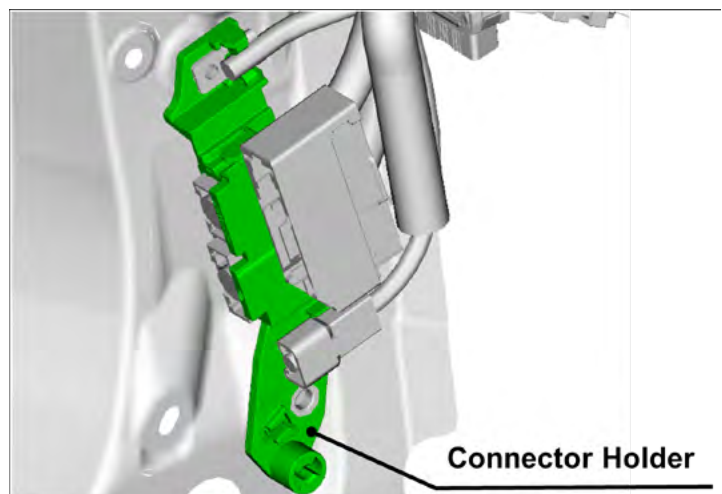

Continued...

STEP 21: Disconnect the original ground wire connection. Connect the new ground harness supplied in the harness kit (SOA635175).

NOTE: The original ground wire will remain in place. The ends will be trimmed in later STEPS.

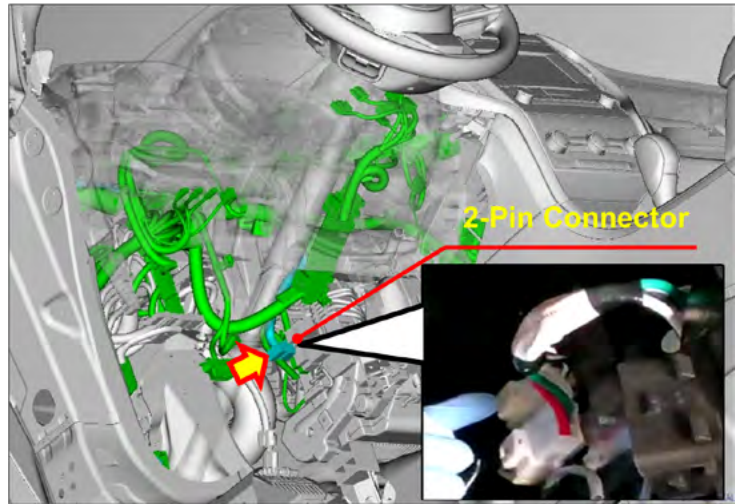

STEP 22: Route the new ground wire along the instrument panel harness as shown below.

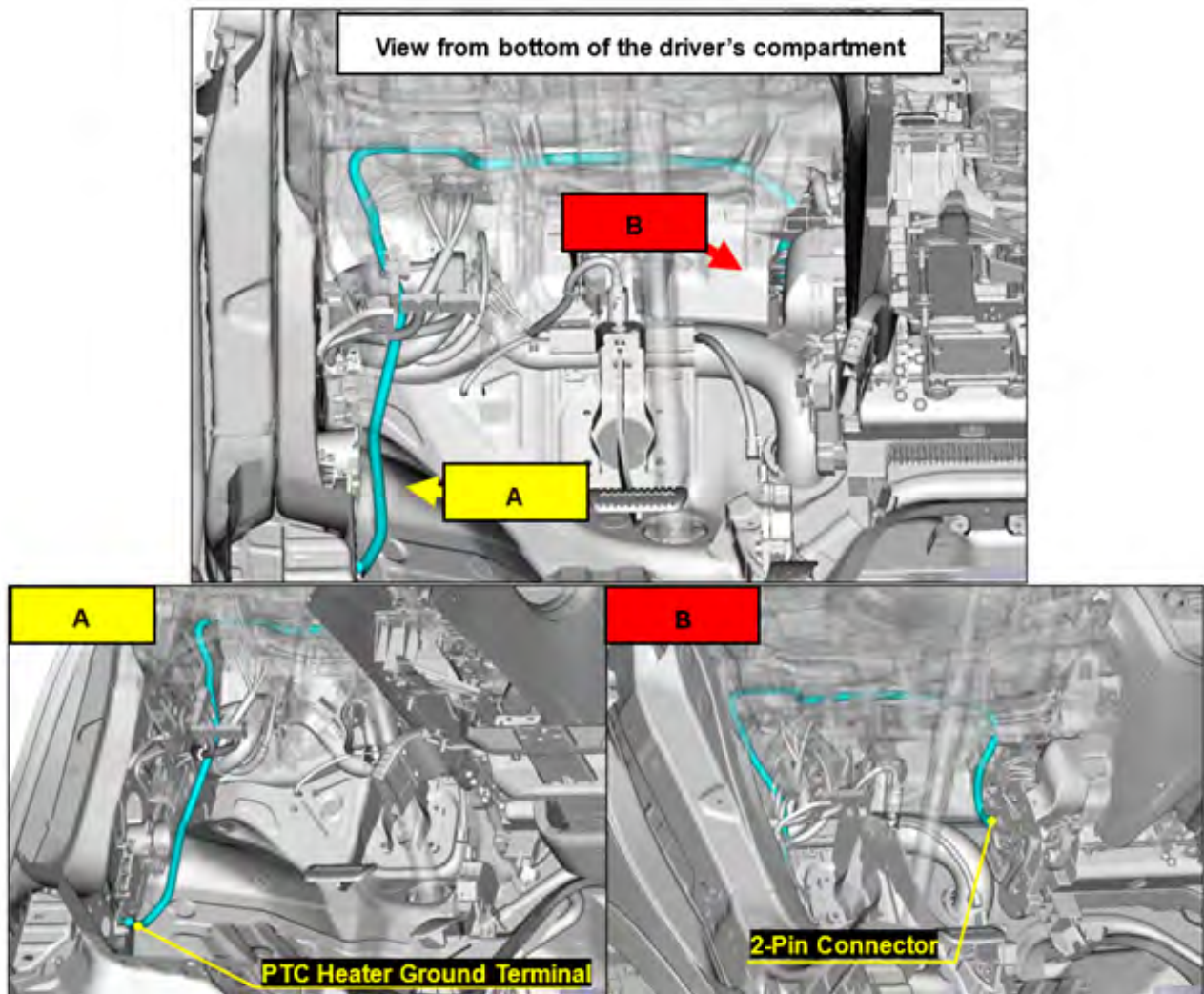

Continued...

STEP 23: Align and attach the ground terminal of the new ground wire to the connector holder.

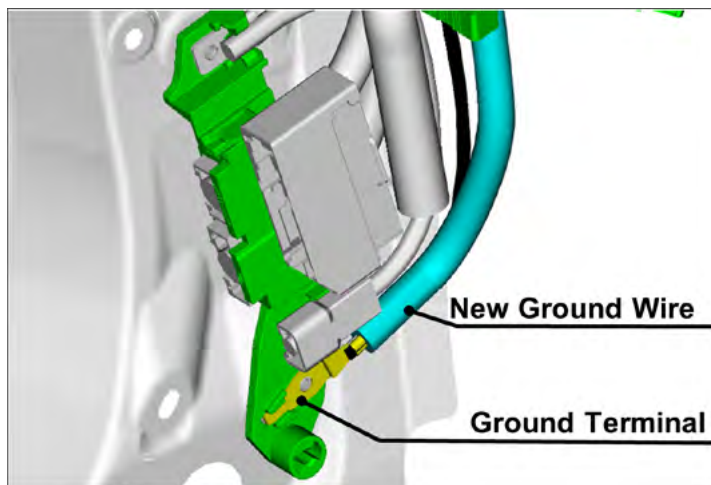

STEP 24: Install the new ground bolts and torque to 13Nm.

IMPORTANT: CONFIRM bolts are torqued to 13Nm.

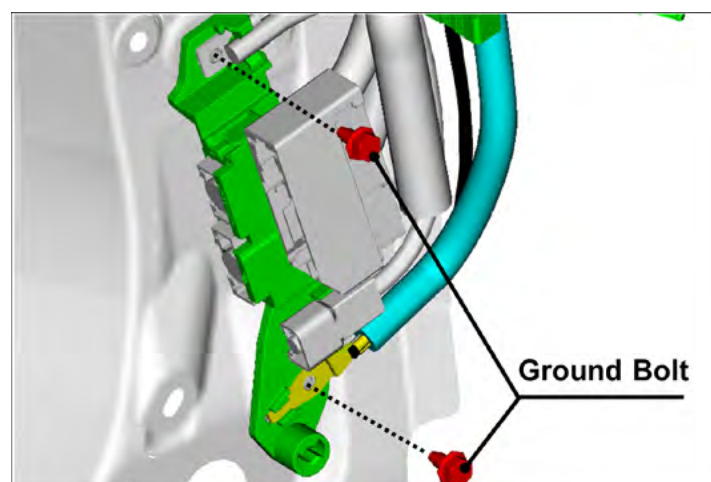

STEP 25: Confirm there is no movement with the ground terminal. Check for any loose contact by attempting to move the terminal with your fingers in an up/down direction. There is no need to pull the ground cable when checking for loose contact.

CAUTION: Any loose connection could cause a possible thermal event.

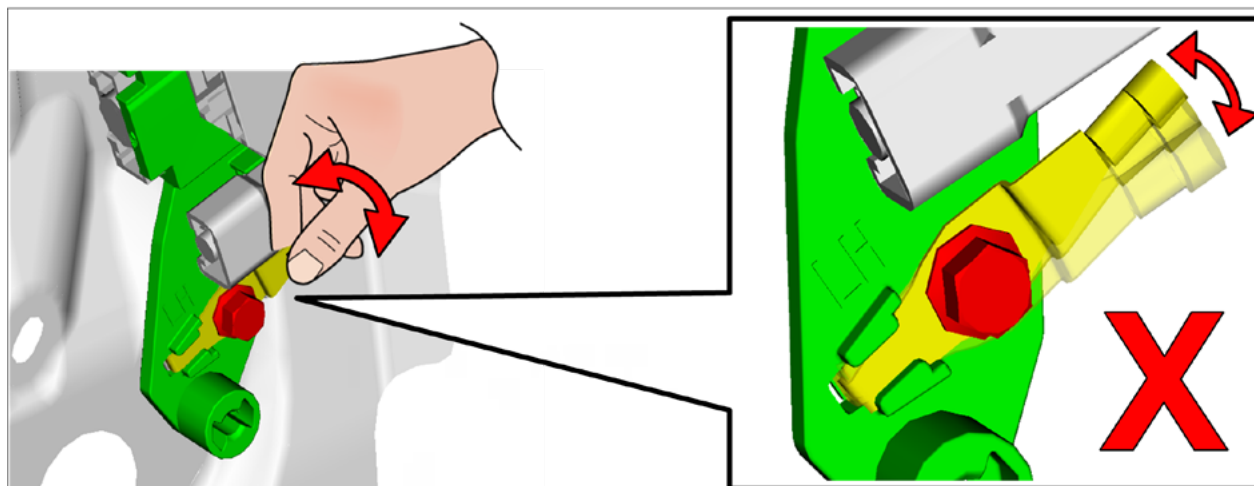

Continued...

STEP 26: Connect all the previously removed connectors to the connector holder.

NOTE: If performing bolt replacement **ONLY**, proceed to STEP 33.



STEP 27: Using cable ties, secure the new ground wire at the six locations indicated in the images below. The original harness wire strap locations can be used as reference. Confirm the tension of the ground wire is evenly distributed.

NOTE: 12-inch wire straps are recommended for the best results.

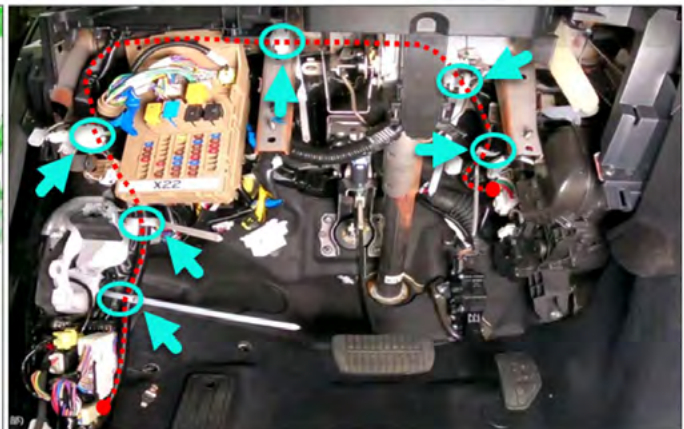
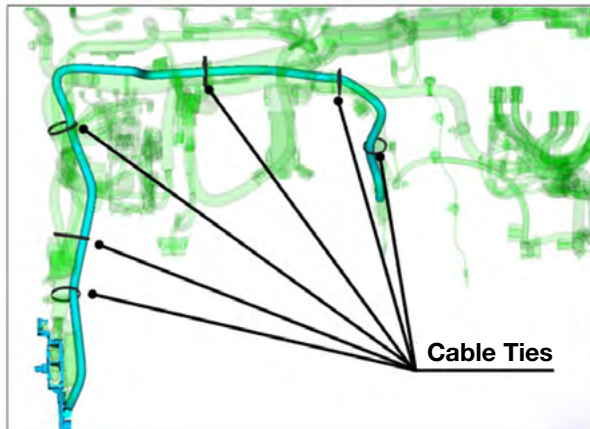

CAUTION: Always trim the edges of the cable ties to prevent any interference with other parts.

STEP 28: Using side cutting pliers, **CAREFULLY** cut the **ORIGINAL** ground wire and remove the terminal.

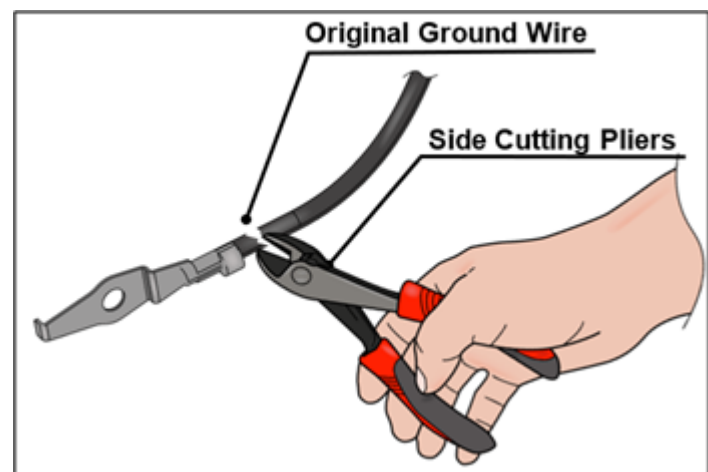

Continued...

STEP 29: Seal the cut end of the original ground wire with electrical insulation tape. The wire can then be taped to the new ground wire.

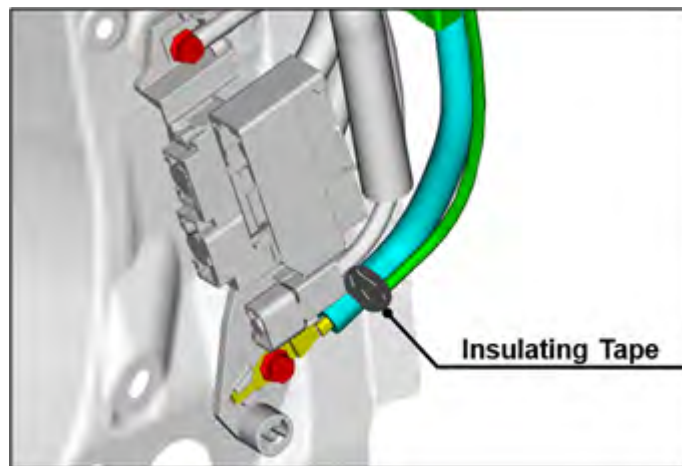

STEP 30: Cut the opposite end of the ORIGINAL ground wire and remove the connector.

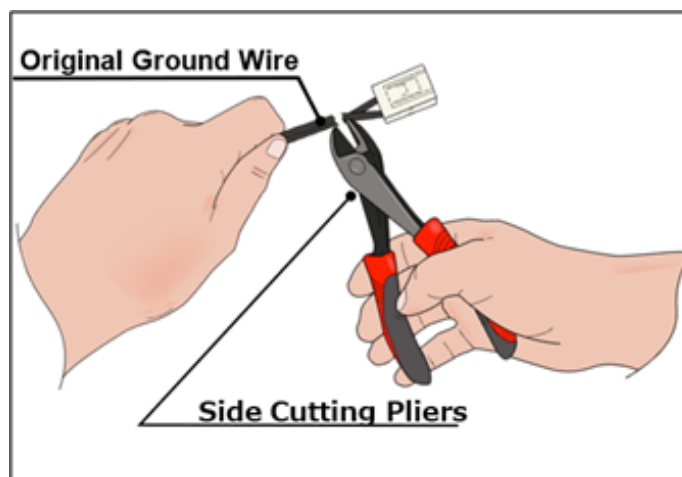

STEP 31: Seal the cut end of the original ground wire with electrical insulation tape. The wire can then be taped to the new ground wire.

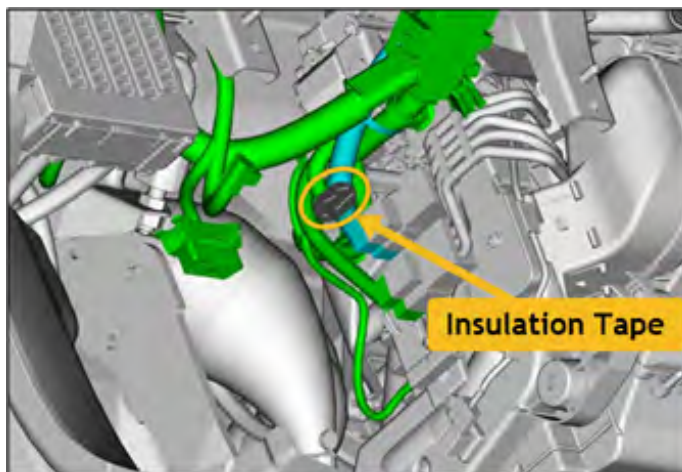

STEP 32: Reinstall all removed parts in the reverse order of disassembly.

IMPORTANT: Whenever reconnecting the ground cable terminal to the battery sensor, torque to 7.5Nm (5.5ft.-lbs. or 66inch.-lbs.) while supporting the sensor with the other hand as outlined in the applicable Service Manual under: STARTING/CHARGING SYSTEMS > Battery Sensor.

Continued...

SERVICE PROGRAM IDENTIFICATION LABEL:

Type or print the necessary information on a Campaign Identification Label. The completed label should be attached to the vehicle's upper radiator support. Additional labels are available through normal parts ordering channels. The part number is **MSA6P1302**, which comes as one sheet of 20 labels.

Part Number	Applicability	Description	Order Quantity
MSA6P1302	All Models	Campaign Completion Labels (contains one sheet of 20 labels)	1

SUBARU
Campaign Code
WRL-22
COMPLETED
DIST./DEALER NO.
SERIAL NO.
DO NOT REMOVE

CLAIM REIMBURSEMENT AND ENTRY PROCEDURES:

Credit to perform this recall will be based on properly completed repair order information. Retailers may submit claims through Subarunet.com.

Labor Description	Labor Operation #	Labor Time	Fail Code
Inspect & Chase and/or Tap Threads	A125-151	0.5	WRL-22
Inspect, Chase & or Tap, Install Harness*	A125-152	0.8	

*A QMR identification number must be noted on the repair order as this information is required for entry in the Miscellaneous Detail field during claim submission.

*Up to \$1.00 can be claimed in sublet for wire straps and insulation tape used during this repair.

*Clear photos of the damage **MUST** be included as an attachment when submitting claims. Failure to include a photo will affect claim processing and payment.

IMPORTANT REMINDERS:

- SOA strongly discourages the printing and/or local storage of service information as previously released information and electronic publications may be updated at any time.
- Always check for any open recalls or campaigns anytime a vehicle is in for servicing.
- Always refer to STIS for the latest service information before performing any repairs.

Continued...

URGENT
IMPORTANT SAFETY RECALL
This notice applies to the VIN identified in
the address section printed below

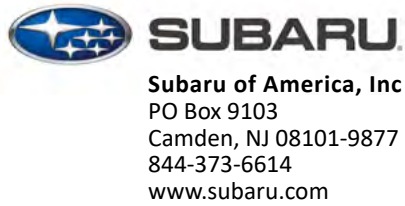

Subaru Safety Recall WRL-22
NHTSA ID 22V-907
January 2023

Dear Subaru Owner:

This notice is sent to you in accordance with the National Traffic and Motor Vehicle Safety Act.

SUBARU OF AMERICA, INC. has decided that a defect, which relates to motor vehicle safety, exists in certain 2019-2022 model year Ascent vehicles.

You received this notice because our records indicate that you currently own one of these vehicles.

DESCRIPTION OF THE DEFECT AND SAFETY RISK

The ground bolt that secures the ground terminal of the Positive Temperature Coefficient (PTC) heater may have been improperly fastened during vehicle production. This potential condition may result in the melting of the ground terminal and surrounding components when the PTC heater is in operation, increasing the risk of a fire.

WHAT SUBARU WILL DO

Subaru will replace the PTC heater ground bolts and, if necessary, replace the ground wire and connector holder at no cost to you.

WHAT YOU SHOULD DO

Please contact your Subaru retailer (dealer) immediately for an appointment to have this repair performed, at no cost to you.

- As a precautionary measure, it is highly recommended that you park the vehicle away from any garage, car port or other structure until this repair is completed.
- Additionally, you should never leave the vehicle unattended while the engine is running until this repair is completed.
- If you notice or smell smoke coming from the dash or driver’s footwell area, the ignition should be placed in the “off” position and the vehicle should not be operated. If this occurs, you should immediately contact Subaru’s Roadside Assistance at 1-800-261-2155 or the nearest Subaru retailer for assistance.

HOW LONG WILL THE REPAIR TAKE?

The time required for this repair is less than one hour. However, it may be necessary to leave your vehicle for a longer period of time on the day of your scheduled appointment to allow your Subaru retailer flexibility in scheduling.

OWNER INFORMATION

Government regulations require that recall notifications be sent to the last known owner of record. That information is based primarily on state registration and title data. If you are a lessor of this vehicle, federal regulations require you to forward this notice to your lessee within ten days.

If you have moved or sold your vehicle, please go to <https://www.subaru.com/support/customer-support.html> to send us your information.

IF YOU HAVE PREVIOUSLY PAID FOR A REPAIR

If you have already paid for repairs associated with this condition, you may be eligible for reimbursement. Reimbursement consideration will be based on the amount an authorized Subaru retailer in your area would charge for the same repair.

Please send the original service repair order, which has the name of the repair facility, date of repair, mileage at the time of repair, complete 17-digit vehicle identification number (VIN), and your name, with correct mailing address and telephone number to the address listed below.

Subaru of America, Inc.
Customer Advocacy Department, Attention: WRL-22 Recall
P.O. Box 9103, Camden, NJ 08101-9877

Please send original receipts only and retain a photocopy for your records. Please be assured that we will attempt to process your reimbursement request as quickly as possible, but it may take up to 60 days for this process to be completed.

IF YOU NEED FURTHER ASSISTANCE:

To locate the nearest Subaru retailer, you can access our website at www.subaru.com and select 'Find a Retailer.'

For additional information, please go to: <http://www.wrl22.service-campaign.com>.

Continued...

If you need additional assistance, please contact us directly:

- By e-mail: Go to www.subaru.com and select “Customer Support”
- By telephone: 1-844-373-6614
Monday through Friday between 8:00 a.m. and 7:00 p.m. ET
- By U.S. Postal mail: Write us at Subaru of America, Inc.
Attn: Customer Advocacy Department
P.O. Box 9103, Camden, NJ 08101-9877

To subscribe to the NHTSA Recall Notification email System, please go to: <https://www-odi.nhtsa.dot.gov/nhtsa/subscriptions>.

Please contact us immediately if the Subaru retailer fails or is unable to make the necessary repairs free of charge.

You may also contact the Administrator, National Highway Traffic Safety Administration (NHTSA), 1200 New Jersey Ave., SE, Washington, DC 20590 or call the toll-free Vehicle Safety Hotline at 1-888-327-4236 (TTY: 1-800-424-9153) or go to <http://www.NHTSA.gov> if you believe the Subaru retailer has failed or is unable to remedy your vehicle without charge within a reasonable amount of time.

Your continued satisfaction with your Subaru is important to us. Please understand that we have taken this action in the interest of your safety and your vehicle’s proper operation. We sincerely apologize for any inconvenience this matter may cause and urge you to schedule an appointment as soon as possible.

Sincerely,

Subaru of America, Inc.

A subsidiary of SUBARU CORPORATION