



Stacy L. Balzer
 Operating Director
 Service Engineering Operations
 Ford Customer Service Division

Ford Motor Company
 P. O. Box 1904
 Dearborn, Michigan 48121

August 7, 2023

TO: All U.S. Ford and Lincoln Dealers

SUBJECT: **NEW VEHICLE DEMONSTRATION / DELIVERY HOLD**
Safety Recall 22S71 Supplement # 1
 Certain 2021-2022 Model Year F-150 Vehicles
 Windshield Wiper Motor Replacement

REF: **Safety Recall 22S71**
 Certain 2021-2022 Model Year F-150 Vehicles
 Windshield Wiper Motor Replacement

New! REASON FOR THIS SUPPLEMENT

- **Affected Vehicles:** *The production dates have expanded.*
- **Service Action:** *Added notes to verify part availability before starting the repair.*
- **Owner Notification Mailing Schedule:** *Phase mailing has started on the parts available letters.*
- **Mobile Repair:** *Sections added to support mobile repairs and claiming.*
- **Additional Repair:** *Statement added on how to obtain approval for additional repairs outside of the bumper-to-bumper warranty.*
- **Part Requirements:** *Parts are now available in limited quantities.*
- **Technical Information:** *Updated tech instructions.*

New! AFFECTED VEHICLES

Vehicle	Model Year	Assembly Plant	Build Dates
F-150	2021	Dearborn	<i>July 21, 2020</i> through November 22, 2021
	2022		September 14, 2021 through August 16, 2022
	2021	Kansas City	<i>August 19, 2020</i> through December 20, 2022
	2022		October 13, 2021 through August 16, 2022
	2022	Rouge Electrical Center	October 14, 2021 through August 16, 2022

US population of affected vehicles: 481,539. Affected vehicles are identified in OASIS and FSA VIN Lists.

Note: Some vehicles may be in the process of being repaired at the plant. Monitor OASIS before opening an RO and/or beginning a repair. Parts purchased for an FSA can be returned for credit if required. See the EXCESS STOCK RETURN details in Attachment II for more information.

REASON FOR THIS SAFETY RECALL

In some of the affected vehicles, the front windshield wiper motor may stop moving or not function. Windshield wipers that do not function correctly can reduce the driver's visibility and increase the risk of a crash.

New! SERVICE ACTION

DO NOT DEMONSTRATE OR DELIVER any new in-stock vehicles involved in this safety recall. Dealers are to replace the front wiper motor. This service must be performed on all affected vehicles at no charge to the vehicle owner.

NOTE: *Do not perform any steps of this FSA unless a wiper motor is available.*

NOTE: *Parts are available in limited quantities.*

***NOTE:** *All motors built with engineering part number ML34-17504-xx must be replaced.*

New! OWNER NOTIFICATION MAILING SCHEDULE

Owner letters stating that no repair is available were mailed the week of January 23, 2023.

Owner letters stating that parts are now available will be mailed in phases starting June 19, 2023.

Dealers should repair any affected vehicles that arrive at their dealerships, whether or not the customer has received a letter.

PLEASE NOTE:

Federal law requires dealers to complete this recall service before a new vehicle is delivered to the buyer or lessee. Violation of this requirement by a dealer could result in a civil penalty of up to \$26,315 per vehicle. Correct all vehicles in your new vehicle inventory before delivery.

New! ATTACHMENTS

- *Administrative Information*
- Labor Allowances and *Parts Availability*
- *Technical Instructions*
- *Mobile Service Repair Assessment*
- Owner Notification Letters
- Recall Reimbursement Plan

QUESTIONS & ASSISTANCE

For questions and assistance, contact the Special Service Support Center (SSSC) via the SSSC Web Contact Site. The SSSC Web Contact Site can be accessed through the Professional Technician System (PTS) website using the SSSC link listed at the bottom of the OASIS VIN report screen or listed under the SSSC tab.

Sincerely,



Stacy L. Balzer

Safety Recall 22S71 **Supplement # 1**

New: MOBILE SERVICE REPAIR ASSESSMENT LEVEL

- All repairs in this program have the following assessment level.:
🔧 🔧 - Light Mobile Service

MOBILE REPAIR RECOMMENDATIONS

- Confirm with the customer a mobile repair is feasible.
- Check OASIS before going to the customer's home or business to confirm if any other outstanding FSA needs to be completed.
- Transportation – due to the simplicity of this repair, a specialty vehicle is not required.

MOBILE REPAIR ADDITIONAL INFORMATION

Please ensure the technician brings the following to the mobile repair destination:

- Printed Technical Instructions
- Printed Repair/Work Order or any other necessary documentation as customer copy(s).
 - Documents could also be emailed to the customer.
- Shirt/uniform and vehicle graphic with the dealership or Ford logos are recommended.

MOBILE REPAIR QUESTIONS AND ASSISTANCE

- For questions and assistance, contact the Special Service Support Center (SSSC) via the SSSC Web Contact Site. Work with the Dealership warranty administrator to create an SSSC contact ID#.
- Once an SSSC agent responds to the new contact ID#, you may opt to call the SSSC hotline: (800) 325-5621.

MOBILE REPAIR CLAIMING QUESTIONS

Dealers participating in the Remote Experience Program:

- Refer to Electronic Field Communication - EFC12071 2023 Remote Experience Program.

OASIS ACTIVATION

OASIS was activated on January 9, 2023.

FSA VIN LISTS ACTIVATION

FSA VIN Lists were made available through <https://web.fsavinlists.dealerconnection.com> on January 9, 2023. Owner names and addresses were made available on January 23, 2023.

NOTE: Your FSA VIN Lists may contain owner names and addresses obtained from motor vehicle registration records. The use of such motor vehicle registration data for any purpose other than in connection with this recall is a violation of law in several states, provinces, and countries. Accordingly, you must limit the use of this listing to the follow-up necessary to complete this recall.

Safety Recall 22S71 *Supplement # 1***SOLD VEHICLES**

- Ford has not issued instructions to stop selling/delivering or driving used vehicles under this safety recall. Owners should contact their dealers for an appointment to have their vehicles remedied as soon as practicable.
- Immediately contact any of your affected customers whose vehicles are not on your VIN list but are identified in OASIS. Give the customer a copy of the Owner Notification Letter (when available) and schedule a service date.
- Correct other affected vehicles identified in OASIS which are brought to your dealership.
- Dealers are to prioritize repairs of customer vehicles over repairs of new and used vehicle inventory.

STOCK VEHICLES

- Correct all affected units in your new vehicle inventory before delivery.
- Use OASIS to identify any affected vehicles in your used vehicle inventory.

DEALER-OPERATED RENTAL VEHICLES

The Fixing America's Surface Transportation (FAST) Act law effective June 2016 prohibits a rental company from selling, renting, or leasing vehicles subject to a safety or compliance recall. Please consult your legal counsel for legal advice.

TITLE BRANDED / SALVAGED VEHICLES

Affected title-branded and salvaged vehicles are eligible for this recall.

OWNER REFUNDS

- **This safety recall must still be performed, even if the owner has paid for a previous repair. Claiming a refund will not close the recall on the vehicle.**
- Ford Motor Company is offering a refund for owner-paid repairs covered by this recall if the repair was performed before the date indicated in the reimbursement plan, which is posted with this bulletin. Owners are directed to seek reimbursement through authorized dealers or, at their option, directly through Ford Motor Company at P.O. Box 6251, Dearborn, MI 48121-6251.
- Dealers are also pre-approved to refund owner-paid emergency repairs that were performed away from an authorized servicing dealer after the end date specified in the reimbursement plan. Non-covered repairs, or those judged by Ford to be excessive, will not be reimbursed.
- Refunds will only be provided for the cost associated with the front wiper motor replacement.

RENTAL VEHICLES

Rental vehicles are not approved for this program.

PICK-UP AND DELIVERY- Participating Dealers

Dealers participating in the Remote Experience Program:

- Refer to EFC12071, 2023 Remote Experience Program, Pickup & Delivery (PDL) Offset section for additional details.
- All customers affected by this program have the option of complimentary Vehicle Pick-up & Delivery service.

Safety Recall 22S71 *Supplement # 1*

New! ADDITIONAL REPAIR (LABOR TIME AND/OR PARTS)

Additional repairs identified as necessary to complete the FSA should be managed as follows:

- For related damage and access time requirements, refer to the Warranty and Policy Manual / Section 6 – Ford & Lincoln Program Policies / General Information & Special Circumstances for FSAs / Related Damage.
- For vehicles within new vehicle bumper-to-bumper warranty coverage, no SSSC approval is required, although related damage must be on a separate repair line with the “Related Damage” radio button checked.
 - Ford vehicles – 3 years or 36,000 miles
- *For vehicles outside new vehicle bumper-to-bumper warranty coverage, submit an Approval Request to the SSSC Web Contact Site before completing the repair.*

New! CLAIMS PREPARATION AND SUBMISSION

- **Claim Entry:** Enter claims using Dealer Management System (DMS) or One Warranty Solution (OWS) online.
 - When entering claims, select claim type 31: Field Service Action. The FSA number (22S71) is the subcode.
 - For additional claims preparation and submission information, refer to the Recall and Customer Satisfaction Program (CSP) Repairs in the OWS User Guide.
- **Related Damage/Additional labor and/or parts:** Must be claimed as Related Damage on a separate repair line from the FSA with the same claim type and subcode as described in Claim Entry above.

IMPORTANT: Click the Related Damage Indicator radio button.
- **Refunds:** Submit refunds on a separate repair line.
 - Program Code: 22S71 - Misc. Expense: ADMIN
 - Misc. Expense: REFUND - Misc. Expense: 0.2 Hrs.
 - Multiple refunds should be submitted on one repair line and the invoice details for each repair should be detailed in the comments section of the claim.
- **Pickup & Delivery:**
 - Dealers participating in the Remote Experience Program –
 - Refer to EFC12071, 2023 Remote Experience Program, Pickup & Delivery (PDL) Offset section for additional details.
- **Mobile Repair:**
 - *Dealers participating in the Remote Experience Program –*
 - *Refer to Electronic Field Communication - EFC12071 2023 Remote Experience Program.*

Safety Recall 22S71 **Supplement # 1**

LABOR ALLOWANCES

Description	Labor Operation	Labor Time
Remove and Replace Front Wiper Motor.	22S71B	0.7 Hours
Wiper Motor does not have service part number ML34-17504-xx. Includes time to remove LH Wiper arm and LH cowl panel grill, using a mirror – inspect part number.	22S71E	0.4 Hours

New! PARTS REQUIREMENTS / ORDERING INFORMATION

Parts are available in limited quantities.

NOTE: Do not perform any steps of this FSA unless a wiper motor is available.

Special Program Part Ordering:

To place an order for a front wiper motor, submit a Special Program order in the DOW system. **SSSC contact is not required to order K-Coded parts on this program.** More information can be found in EFC 10642.

Part Number	Description	Order Quantity	Claim Quantity
ML3Z-17508-E	Front Wiper Motor	1	1

Dealers will be notified via a DOES II communication if circumstances warrant a change in part supply strategy and when open ordering resumes.

To guarantee the shortest delivery time, an emergency order for parts must be placed.

***NOTE:** All motors built with engineering part number ML34-17504-xx must be replaced.

DEALER PRICE

For the latest prices, refer to DOES II.

PARTS RETENTION, RETURN, & SCRAPPING

Follow the provisions of the Warranty and Policy Manual, Section 1 - WARRANTY PARTS RETENTION AND RETURN POLICIES. If a replaced part receives a scrap disposition, the part must be scrapped by all applicable local, state, and federal environmental protection and hazardous material regulations. Federal law prohibits selling motor vehicle parts or components that are under safety, compliance, or emissions recall.

EXCESS STOCK RETURN

The excess stock returned for credit must have been purchased from Ford Customer Service Division by Policy Procedure Bulletin 4000.

Safety Recall 22S71 *Supplement # 1*

REPLACED FSA PARTS INSPECTION AND SIGN OFF

Effective March 1st, 2021, all parts replaced as part of an FSA repair with a repair order open date of March 1st, 2021, or later must be inspected and signed off on the repair order by a member of your dealer fixed operations management team or an employee of the task has been delegated to. If the task is to be delegated to a non-management employee, the employee needs to be someone other than the technician who completed the repair and needs to understand the importance of completing this task consistently and accurately.

- All parts replaced as part of an FSA repair should be returned to the parts department following the Warranty Parts Retention and Return Policies.
- Inspect the replaced parts to verify the FSA repair was completed.
- If the FSA repair is found to be complete, the designated employee signs the repair order line or parts return stamp area (electronic or hand signed) for the FSA repair indicating the parts were inspected and validated to have been replaced.
- After the parts have been inspected, they should be handled based on the guidance in the parts status report in the Online Warranty System (Hold, Return, CORE, Scrap, etc.).
- This process is subject to review during warranty audits for FSA repairs with a repair order open date of March 1st, 2021, or later. Any eligible FSA claims requiring parts replacement found not to have been inspected and signed off during a warranty audit will be subject to chargeback and consideration for enrollment into the Dealer Incomplete Recall Repair Process.

Note: Other approvals (electronic or handwritten) for add-on repair lines, dealer-owned vehicle repairs, and repeat repairs do not qualify as FSA parts inspection approvals. The post-repair FSA parts inspection process (electronic or handwritten) is independent of other warranty approval requirements. The approval by the designated employee implies that the FSA parts were found to be replaced and must be able to be identified on the Repair Order. If multiple FSAs require approval on a single Repair Order, each applicable occurrence will require individual post-repair approval by the designated employee.

CERTAIN 2021-2022 MODEL YEAR F-150 VEHICLES - WIPER MOTOR REPLACEMENT

SERVICE PROCEDURE

⚠ WARNING: Do NOT perform any of the following Field Service Actions steps UNLESS the correct windshield wiper motor part number is available for replacement.

1. Remove the windshield wiper pivot arm. Left hand side only. See Figure 1.

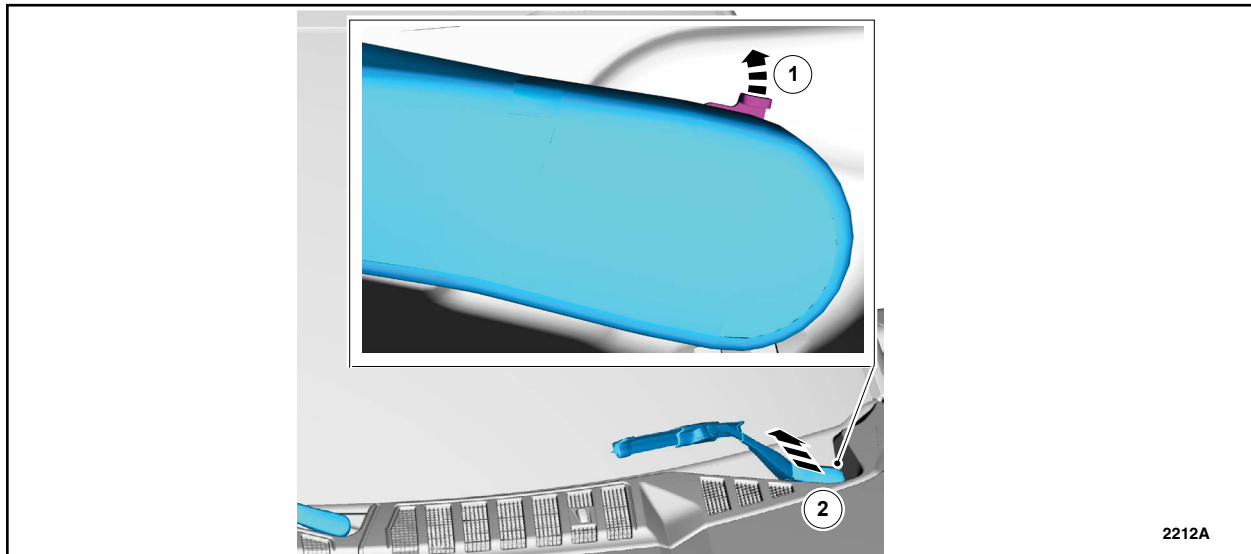

FIGURE 1

2. Remove the cowl panel grille. Left hand side only. See Figure 2.

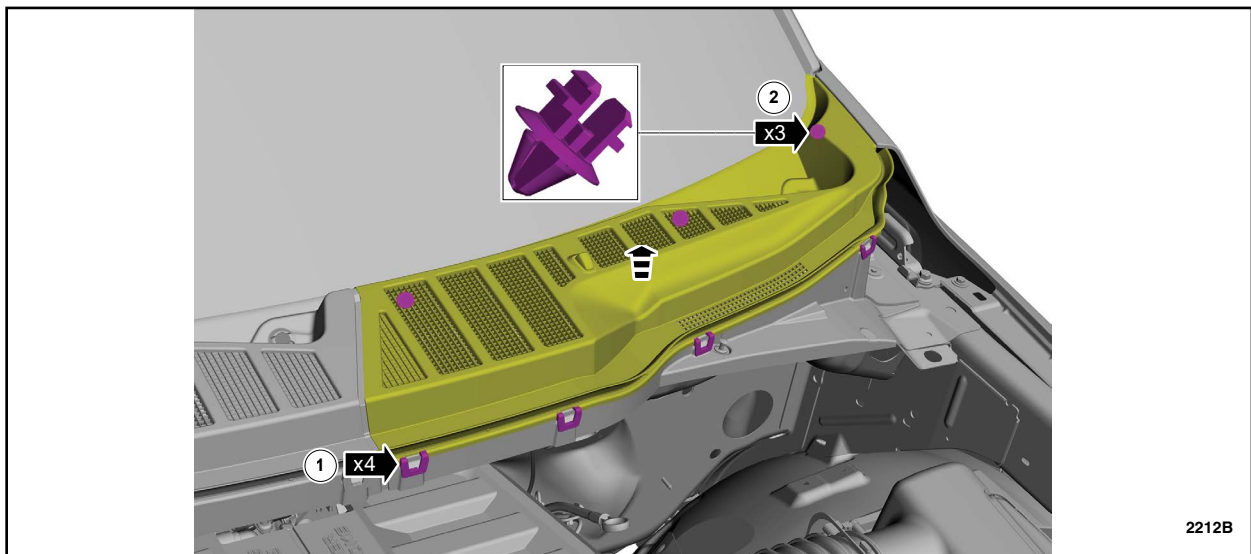

FIGURE 2



- Using a mirror, look underneath the wiper motor to locate the part number. Record part number. See Figure 3.



FIGURE 3

- Looking at the recorded part number, is the part number ML34-17504-xx?
No - Reassemble vehicle. Recall is complete.
Yes - Install new wiper motor. Please follow Workshop Manual (WSM) procedures in Section 501-16.















Safety Recall 22S71 **Supplement # 1** Mobile Service Repair Assessment

Assessment levels have been identified to help determine the ease of performing eligible mobile service repairs for a Field Service Action (FSA) outside of the dealership service facility.

Dealer Bulletin



Within Attachment I of the dealer bulletin a mobile service repair assessment level(s) will be provided. These assessment levels have been determined using the amount of time, equipment and labor identified to perform the intended service action.

Assessment Levels

-  - Mobile Reprogramming
-   - Light Mobile Service
-    - Enhanced Mobile Service
-     - Advanced Mobile Service
-  - Wheel and Tire Mobile Service
-  - Not Mobile Service Eligible

Description of each level that is used to determine the overall assessment.

-  – Mobile Reprogramming
 - Module Programming or similar type services
 - Minimum tools maybe required other than an **IDS/FDRS** setup
 - FDRS programming that requires internet connection (wi-fi or mobile hotspot)
 - Make sure vehicle has a charge port to ensure battery voltage is maintained during flashing of the module(s)
 - Repairs not greater than 1 hour in length (including time to wait for programming)

Note: The location will need a charging station or wall box to maintain the 12-volt battery.
-   – Light Mobile Service
 - Interior repair procedures that do not require seat, dash, or headliner removal
 - Under hood repairs that do not require large component removal
 - Exterior repairs that do not require large component/panel removal
 - Repairs may require standard hand tools (Access to a Technician starter kit or similar)

Compliance Recall 22S71 *Supplement # 1*

   – Enhanced Mobile Service

- ***A two-person process is required anytime a procedure requires work under the vehicle***
- Brake Inspection and Brake Repair/Replacement
- Limited Suspension Component replacement (no alignment)
- Under Vehicle access for limited repairs (no large component removal)
- Vehicle Check Up - VCU
- Pre-Delivery Inspection - PDI
- Used Car Inspection/Presale Inspection
- May require floor jack, jack stands, and impact tools

Note: Wheel lock may be required.

    – Advanced Mobile Service

- Fluid Exchange/Oil Change
- Light Repairs
- Brake Hydraulic Repairs

 – Wheel and Tire Mobile Service

- Tire Removal from Wheel
- Tire Balancing
- Tire Repair

Note: Specialized Mobile Service unit and equipment including Tire balancer and Tire Changer required.

 – Not Mobile Service Repair Eligible

- Large component removal
- BEV Battery Replacement
- Requires a vehicle hoist – to complete the repair (more than inspection)
- Required vehicle alignment
- Requires significant vehicle disassembly
- Repairs greater than 2-3 hours
- Any repairs that require M-Time
- Includes a service procedure where the vehicle owner may be distressed about the state of their vehicle

Ford Motor Company
Recall Reimbursement Plan for 22S71

Ford and Lincoln dealers are in the best position to quickly and efficiently process reimbursement requests. However, federal legislation requires all motor vehicle manufacturers to establish processes through which customers may seek recall reimbursement directly from the manufacturer or from the dealers.

Regarding the specific reimbursement plan for Recall # 22S71, owners who have paid for service to remedy the defect or noncompliance must have had that service performed prior to January 23, 2023. After this date, if repairs related to this recall are performed by a non-Ford repair facility in an emergency situation, customers must submit any refund requests through their dealership. As required by this federal regulation, Ford Motor Company submitted the details of its latest General Recall Reimbursement Plan in a letter to the National Highway Traffic Safety Administration (NHTSA) in May 2021. The following is the text of that letter and the Plan:

General Recall Reimbursement Plan
(As submitted to the NHTSA)

Pursuant to the requirements set forth in 49 CFR Part 573 and Part 577 of the Code of Federal Regulations, Ford Motor Company (Ford) is submitting the required information pertaining to our general reimbursement plan for the cost of remedies paid for by vehicle owners before they are notified of a related safety recall.

Set forth below is Ford's general plan to reimburse owners and purchasers for costs incurred for remedies in advance of notification of potential safety-related defects or noncompliance pursuant to Part 573.6 (c)(8)(i). This plan has not changed since our February 20, 2019 submission.

Reimbursement Notification

Ford's notice to a vehicle owner in accordance with 49 CFR Part 577 will indicate that Ford is offering a refund if the owner paid to have service to remedy the defect or noncompliance prior to a specified ending date. In accordance with Part 573.13 (c)(2), this ending date will be defined as a minimum of ten calendar days after the date on which Ford mailed the last of its Part 577 notifications to owners and will be indicated in the specific reimbursement plan available to owners for an individual recall. This notice will direct owners to seek eligible reimbursement through authorized dealers or, at their option, directly through Ford at the following address:

Ford Motor Company
P.O. Box 6251
Dearborn, MI 48121-6251

Ford notes that this rule allows for the identification of a beginning date for reimbursement eligibility. Under the rule, an owner who paid to remedy the defect or noncompliance prior to the identified beginning date would not be eligible for reimbursement. Ford generally has not established such a beginning date for reimbursement eligibility and does not presently anticipate changing this general policy. However, in any case where Ford determines a beginning date is appropriate, Ford will indicate that date in the owner notice. As permitted by 577.11(e), Ford may not include a reimbursement notification when all vehicles are well within the warranty period, subject to approval by the agency.

Costs to be Reimbursed

For vehicles, reimbursement will not be less than the lesser of:

- The amount paid by the owner for the remedy that specifically addressed and was reasonably necessary to correct the defect or noncompliance that is the subject of the recall, or
- The cost of parts for the remedy (to be no more than the manufacturer's list retail price for authorized part(s), plus associated labor at local labor rates, miscellaneous fees (such as disposal of waste), and taxes.

For replacement equipment, reimbursement will be the amount paid by the owner for the replacement item (limited by the amount of the retail list price of the defective or noncompliant item that was replaced, plus taxes, where the brand or model purchased by the owner was different from the brand or model that was the subject of the recall). If the item of motor vehicle equipment was repaired, the reimbursement provisions identified above for vehicles will apply.

Ford notes that costs incurred by the owner within the period during which Ford's original or extended warranty would have provided for a free repair of the problem will not be eligible for reimbursement, as provided by Part 573.13 (d)(1).

Entities Authorized to Provide Reimbursement

Ford will continue to use authorized dealers to reimburse owners under the specific reimbursement plans for a particular recall and will encourage owners to pursue requests for reimbursement directly through dealers to expedite reimbursement. Ford will also provide a mailing address to which customers can, at their option, send requests for reimbursement directly to Ford, as previously noted. Requests for reimbursement sent directly to Ford may take up to 60 days to process. Whether the owner chooses to pursue reimbursement requests through a dealer or directly through Ford, the owner will be directed to submit the required documentation, upon which reimbursement eligibility will be determined.

Required Documentation

The reimbursement determination will depend upon the information provided by the customer. Consistent with Part 573.13 (d)(4) the following information must be submitted:

- Claimant's name and address
- Vehicle make, model, and model year
- Vehicle identification number (VIN) and, for replacement equipment, a description of such equipment or, for tires, the model, size, and TIN (DOT code)
- Identification of the recall number (either the Ford recall number or the NHTSA recall number)
- Identification of the owner of the recalled vehicle at the time that the pre-notification remedy was obtained
- An original receipt for the pre-notification remedy that includes a breakdown of the amount for parts, labor, other costs, and taxes, including costs for the replacement item. Where the receipt covers work other than to address the recall or noncompliance, Ford may require the claimant to separately identify costs that are eligible for reimbursement.
- If the remedy was obtained during the warranty period, documentation indicating that the warranty was not honored, or the warranty repair did not correct the problem related to the recall.

Failure to submit all of the above information may result in the denial of the reimbursement request.

Additional Information

The Part 577 required owner notice will provide a toll-free telephone number through which specific information about the reimbursement plan can be requested from Ford. This general reimbursement plan will be incorporated into notifications pursuant to Part 573.6 by reference. Information specific to an individual recall also may be incorporated into the Part 573.6 notification.