

Technical BULLETIN

©2022 YAMAHA MOTOR CORPORATION, U.S.A.

SAFETY RECALL

This modification has top priority. This bulletin must be performed immediately to ensure customer safety.

NOTE: Bulletins that announce a recall will have an "R" at the end of the bulletin number.

CERTAIN 2021 MODEL MTT9GTM/MC (TRACER 9 GT) MOTORCYCLES FACTORY MODIFICATION CAMPAIGN – Throttle Grip Tube

i

INTRODUCTION

Yamaha Motor Corporation, U.S.A. has decided that a defect that relates to motor vehicle safety exists in certain 2021 model MTT9GTM/MC (Tracer 9 GT) motorcycles.

In affected motorcycles, if the throttle grip is used to pull up a motorcycle that has fallen on its side, the throttle grip tube may break at the guide due to the excessive lateral pulling force applied to it because of an improperly designed grip end. If the guide is broken, the broken portion could restrict throttle movement during operation, which could result in loss of control and a crash with severe injury or death.

To correct this defect, Yamaha is initiating a Factory Modification Campaign. Affected units must have the grip end replaced. If the throttle grip tube is already broken, it must be replaced using a grip warmer kit that includes a new throttle grip tube before installing the new grip end.

Yamaha is notifying all registered owners of affected motorcycles by mail. A copy of our letter is included in this bulletin. The customer should take this letter along with the affected motorcycle to an authorized Yamaha dealer for modification.

If your dealership was invoiced for one or more affected units, a computer report listing all affected motorcycles invoiced to your dealership is included with a mailed copy of this bulletin. Use the list to help ensure all motorcycles are modified. All sold motorcycles that have been registered with Yamaha will show the customer's name and address.

Your dealership must notify the owner of any affected motorcycle that was actually sold but listed as "unsold" in the report. You must modify all affected motorcycles in your inventory as well as all customer-owned motorcycles brought to you for this service. Any affected motorcycle that you purchase from Yamaha in the future may also require modification. If you purchase a motorcycle from another dealer or Yamaha, check to see if the procedures in this bulletin have already been performed before you sell the motorcycle.

Motorcycles that are affected should not be operated until they are modified. It is a violation of Yamaha policy for your dealership to deliver any affected motorcycle to customers until the procedures in this bulletin are performed.

NOTE: Check to see if the unit you are modifying is also affected by the Factory Modification Campaign for the ECU reprogramming announced in Technical Bulletin M2022-006R. Perform both procedures at the same time for customer convenience and shop efficiency.

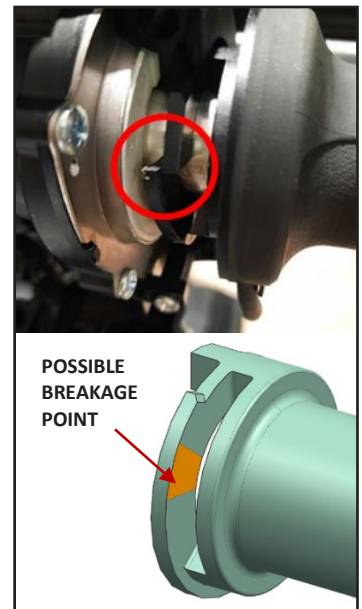

When the modification on each motorcycle is performed, follow the Warranty Information section of this bulletin to receive reimbursement. Be sure to use the Factory Modification Campaign procedures in Chapter 7 of the *Warranty and Y.E.S. Handbook* (LIT-11760-00-21).



DEALER ACTION SUMMARY

Unsold &

Sold Units: Use YDS Unit Status to check to be sure the unit is affected and that it is not already modified; confirm by checking the motorcycle according to the *Identification Procedure* section of this bulletin. If the unit is affected and unmodified:

- Check to see if the throttle tube guide is broken.
- If the guide is not broken, replace the grip end with the new type.
- If the throttle tube guide is broken, replace the entire grip warmer switch assembly, and then install the new grip end.

Parts: Yes. Order a new end grip kit for each affected unit. If the throttle grip is damaged, also order the grip warmer kit. See the *Parts Information* section of this bulletin for more information.

Warranty: Factory Modification Campaign. See the *Warranty Information* section of this bulletin. This modification applies to all affected units regardless of ownership or warranty status.

Notify

Customers: Yes, you must immediately contact any customer whose Tracer 9 GT shows as unregistered on the report enclosed with the mailed copy of this bulletin. Yamaha has sent letters to customers whose motorcycles were registered with Yamaha as of 3/16/2022.



AFFECTED RANGE

Check Unit Status on YDS to make sure the Primary ID (PID) is in the Affected Range and is eligible for this repair. The affected unit ranges for this issue are:

Model Year	Model	Primary ID		
		Prefix	To	From
2021	MTT9GTM	RN74E	0000301	0000684
	MTT9GTMC	RN74Y	0000301	0000381

IMPORTANT: Affected Primary IDs may not be consecutive. Always check YDS Unit Status before starting any repair.



SERVICE PROCEDURE

DETACHING HANDLEBAR-RELATED PARTS

1. Turn off the main switch. Put the motorcycle on the main stand on a flat surface.
2. Remove the brush guard (right) ① and brake master cylinder mounting nut ②. Then remove the brush guard upper bracket ③ and mounting bolts ④.
 Mounting Nut ② Tightening Torque: 4 Nm (0.4 m-kg, 3.0 lb-ft)
 Mounting Bolts ④ Tightening Torque: 7 Nm (0.7 m-kg, 5.2 lb-ft)

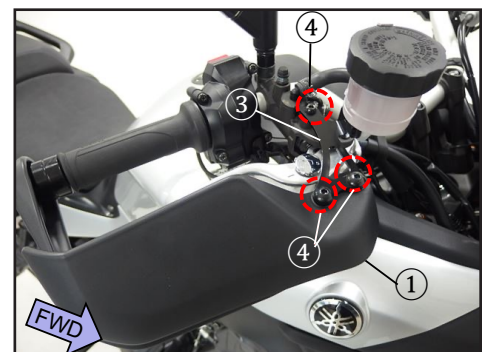

NOTICE:

Protect the surrounding area to prevent scratching.

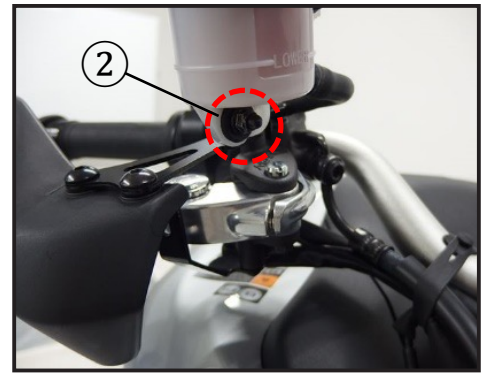

NOTICE:

Be careful not to lose the two collars in the brush guard after removing the mounting bolts.

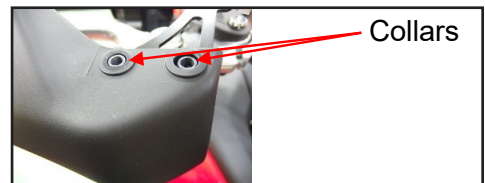

3. Remove the grip end 2 (5) and mounting bolt (6). Remove the spacer (7).
Grip End Mounting Bolt Tightening Torque: 17 Nm
(1.7 m-k_g, 12.5 lb-ft)

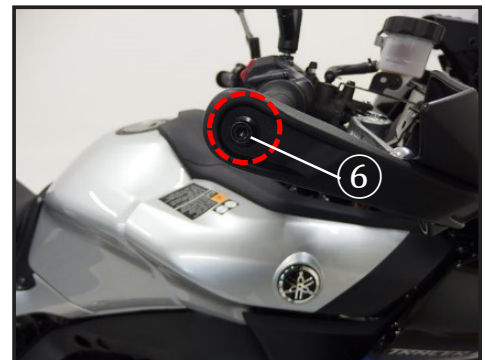

CHECKING THE THROTTLE TUBE

1. Remove the four mounting screws from the handle switch (right).
Mounting Screws Tightening Torque: 1.8 Nm (0.18 m-k_g, 1.3 lb-ft)

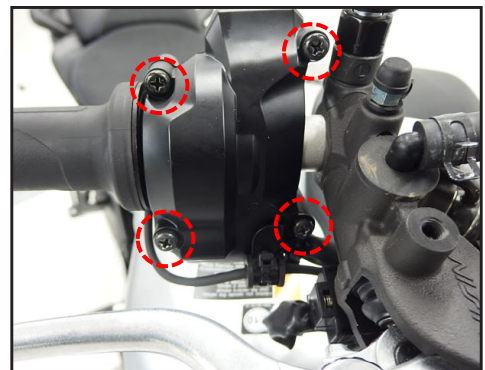

2. Check whether the guide part ② of the throttle pipe is damaged or cracked.

TIP: Visually check the gap between the guides. Using a screwdriver, lightly tap the part to check for cracks. Apply light pressure to prevent damaging the throttle guide.

NOTICE:

Do not press hard with the screwdriver to avoid damaging a good throttle guide.

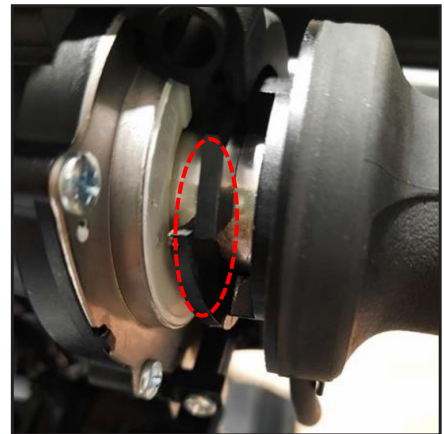
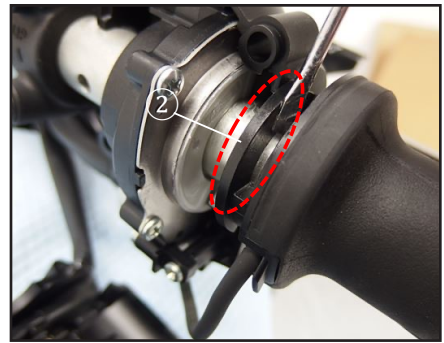

Check for cracks between engraved “P” and “Y”. If no damage or cracks are present, replace the grip end. If there is damage or cracks, go to **“If the Throttle Pipe Guide Is Damaged”** on page 5.



Replacing the Grip End

1. Remove the Grip End (Right) ① from the handlebar.

TIP: As shown, pull the handle switch and the throttle grip in, away from the end by about 10mm to completely expose the width of the flat on the grip end.

Grip End Tightening Torque: 26 Nm (2.6 m-kg, 19 lb-ft)

2. Remove the grip end (right) then reverse the procedure to install the new grip end.

TIP: The end of the grip end (right) of the new countermeasure part has a flange.

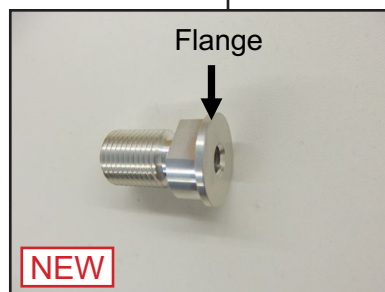
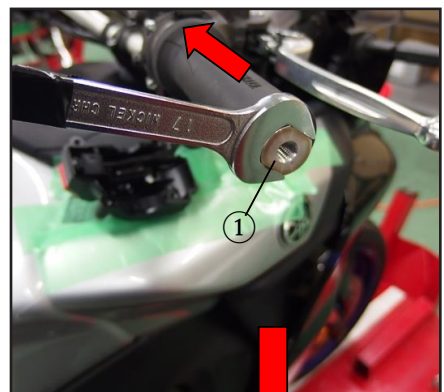

HANDLEBAR-RELATED PARTS ASSEMBLY

1. Reinstall the handle switch (right) ①, referring to the torque values given in the disassembly procedure.

TIP: Reinstall the components in this order:

- Rear side handle switch (right) assembled to handlebar ②.
- Handle switch (right) ① protrusion "A" on the rear side is aligned with hole "B" in the handlebar ②.

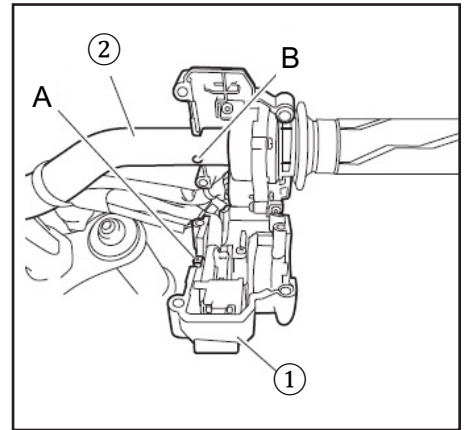

2. Reassemble the handlebar-related parts in reverse order of disassembly.

IF THE THROTTLE PIPE GUIDE IS DAMAGED

Detaching Exterior Parts:

1. Remove bolt "a" and quick fasteners "b," and the front side cowling assembly (left) "1".
Bolt "a" Tightening Torque: 2.5 Nm (0.25 m-kg, 1.8 lb-ft)

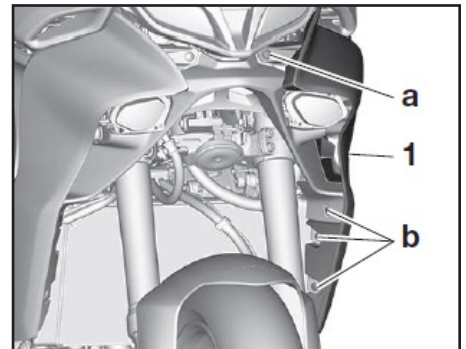

2. Remove the front-side cowling assembly (right).

3. Remove quick fasteners "a" and lift the fuel tank top cover "1" toward the front.

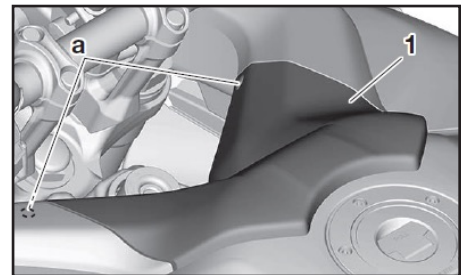

NOTICE:

Be sure the main key is removed to prevent damage to the cover.

4. Remove bolts "A" and quick fasteners "B," and the headlight cover "1."

Bolts Tightening Torque: 9 Nm
(0.9 m-kg, 6.6 lb-ft)

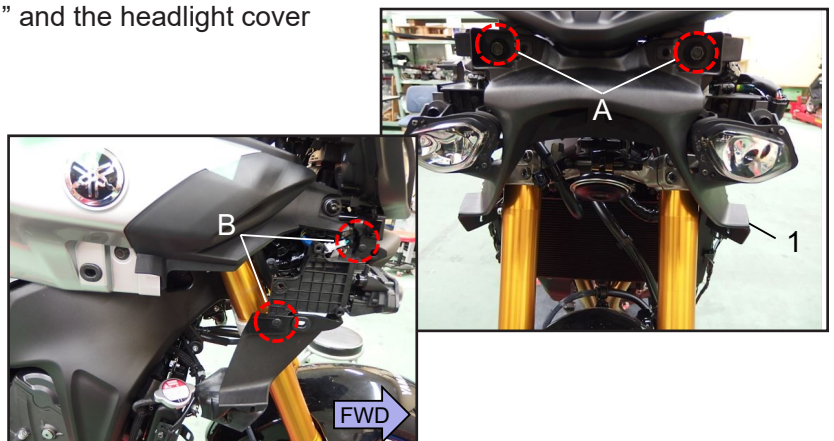

- Remove bolts "a" and collar "b," and fuel tank cover assembly (right) "1."

Bolts Tightening Torque: 9 Nm (0.9 m-kg, 6.6 lb-ft)

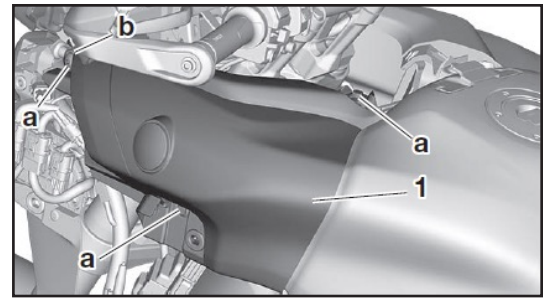

- Remove the fuel tank side cover assembly (left).

Detaching the Headlights

- To remove the headlights, first remove the wire sub-lead connector from the fixed clamp to provide a clear path to access the four mounting bolts.

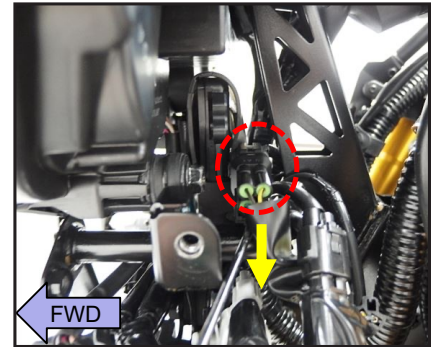

- Remove the four mounting bolts and remove the headlight.

TIP: Disconnect the two flasher light connectors (1, 2) and remove the two headlight connectors (3 and 4).

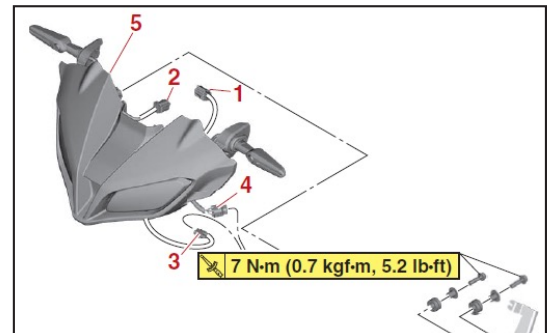

Detaching the Connectors

- Remove the securing band on the right side of the handlebar ①.

TIP: Do not cut the band because it will be reused.

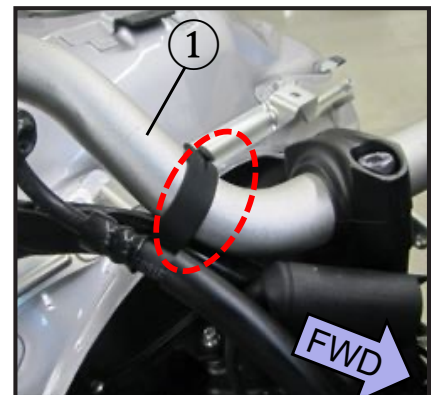

- Disconnect the black 2-pin connector for the electronic suspension (right) lead wire ②.



3. Disconnect the white 2-pin connector (electronic suspension [right]) and the black 6-pin connector of the handlebar switches.

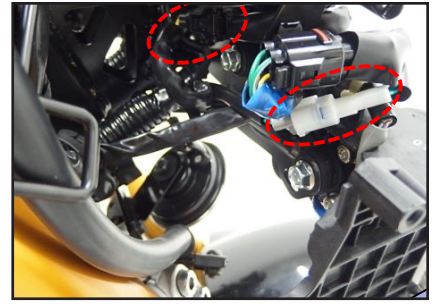

4. Disconnect the gray 2-pin connector of the grip warmer and the white 6-pin/white 3-pin connectors for the switches.

TIP: Remove the white 6-pin connector ③ from the holder ④ for workability.

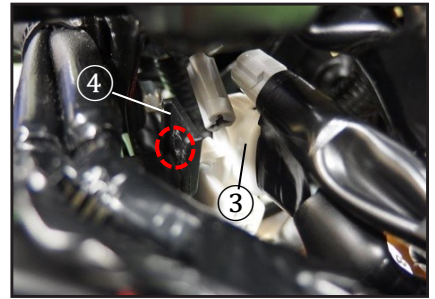
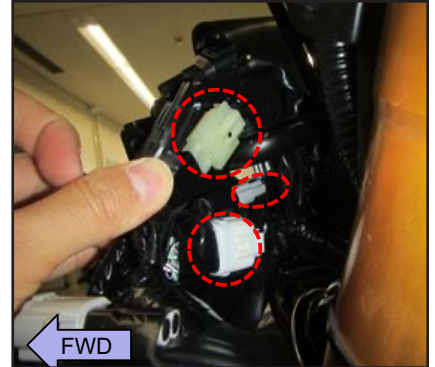

5. Cut the band on the right-hand handlebar holder.

TIP: When assembling, use the new part included in the countermeasure parts kit.

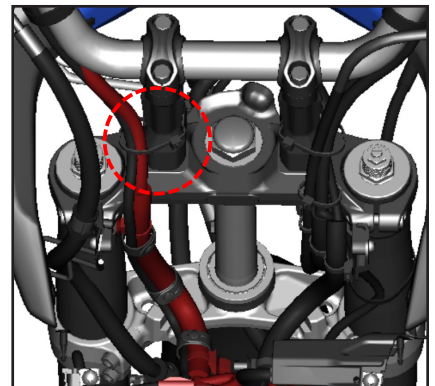

6. Remove the plug-in clamp of the tab in two places on the corrugated tube covering the handle switch (right).

TIP: Cut the plug-in part on the upper brake hose holder side. Remove the tabs or cut the lower part stay side.

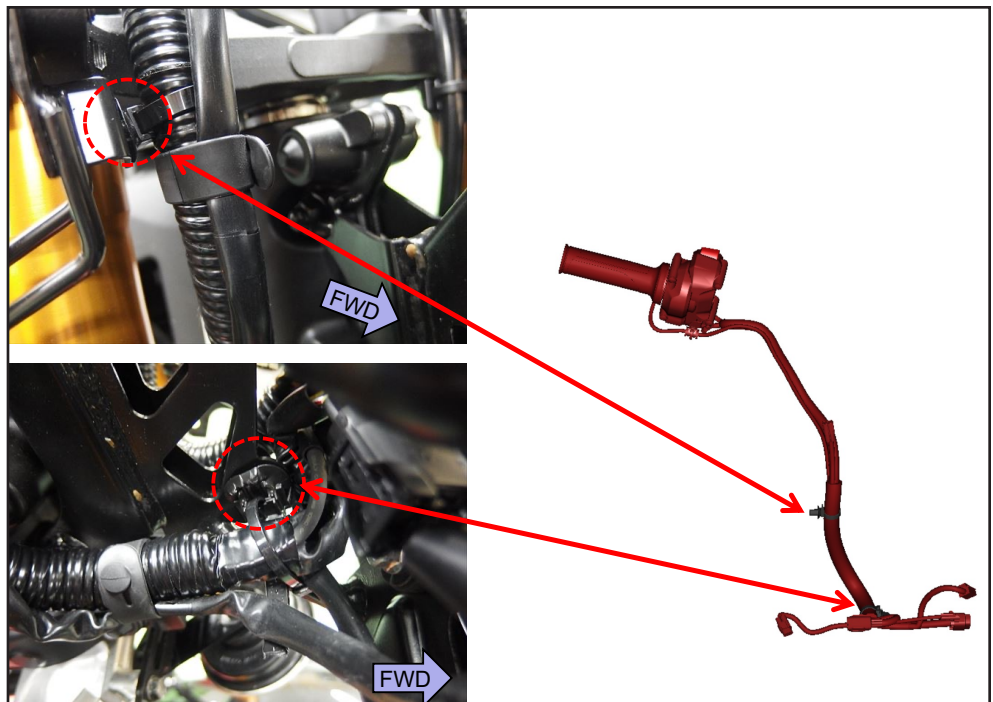

7. Remove the three securing bands, making note of their position.

TIP: Do not cut these bands because they are reused.

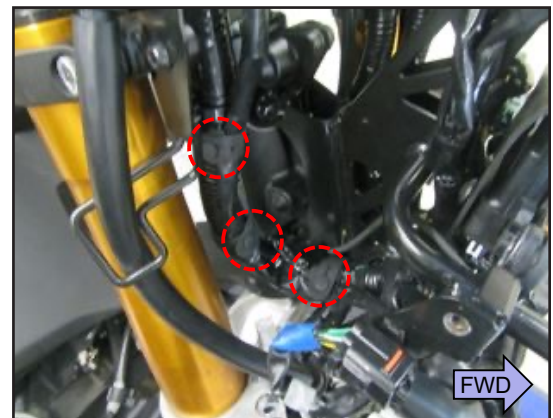

Replacing the Cord Switch Comp

1. Remove the Cord Switch Comp ① and reverse assemble the new Cord Switch Comp in the order below.

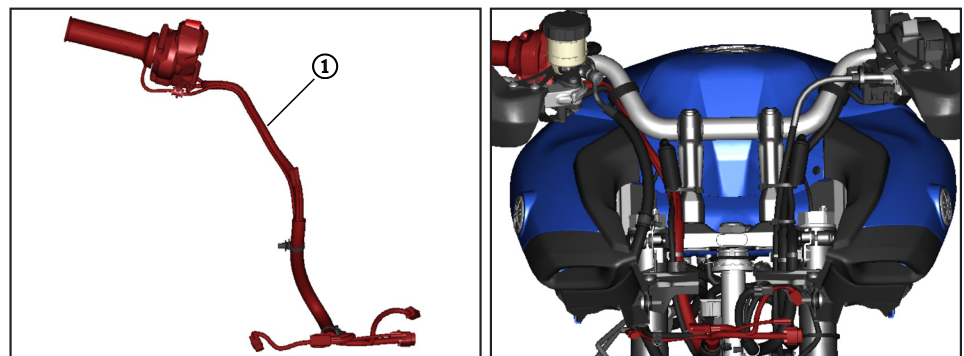

TIP: Do not reuse the damaged Cord Switch Comp. Refer to the Service Manual for proper routing of the cables, wires, and pipes.

2. Route to the rear/inside of the vehicle with the brake hose ②.
3. Insert the two plug-in clamps on the corrugated tube.

TIP: See Step 6 in “Detaching the Connectors.”

4. Connect each connector in the reverse order of removal.

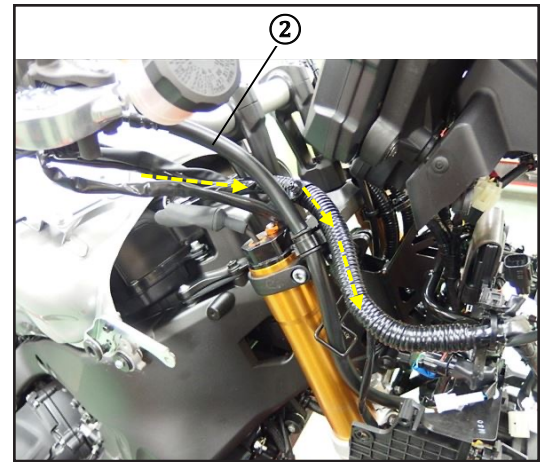

5. Attach the securing bands at three positions.

Cable routing ①

Place the band within 10mm of the holder that secures the front brake light switch lead wire and switch handle lead wire assembly (right) to the upper bracket at the taped position of the front brake light switch lead wire. Pass the front brake light switch lead wire through the front side of the switch handle lead wire assy (right).

Cable routing ②

Clamp the front brake light switch lead wire and switch handle lead wire (right) with a band at the taped position on the front brake light switch lead wire. Pass the front brake light switch lead wire through the outer side of the switch handle lead wire assy (right).

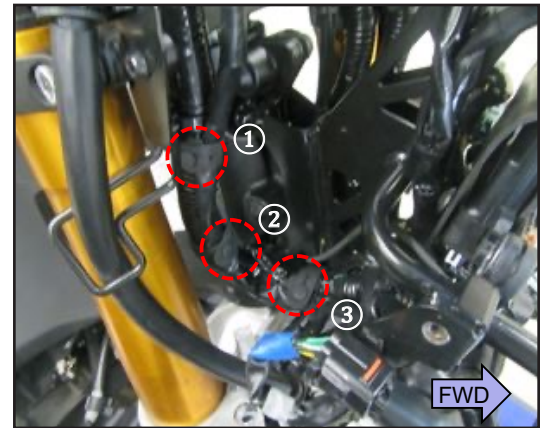

Cable routing ③

At the taped position on the front brake light switch lead, clamp the front brake light switch lead and the switch handle lead wire assembly (right) with a band. Place the band within 10 mm of the holder that secures the switch handle lead wire assembly (right) to the frame. Pass the front brake light switch lead wire to the outside of the switch handle lead wire (right).

6. Secure the following lead wires with the band included in the countermeasure parts KIT at the lower part of the right handlebar holder.
 - Grip warmer lead wire
 - Electronic suspension lead wire
 - Front brake light switch lead wire
 - Switch handle lead wire

TIP: Position the end of the band on the inside in front of the vehicle. Cut off the unused portion of the tip of the band at 5mm or less.

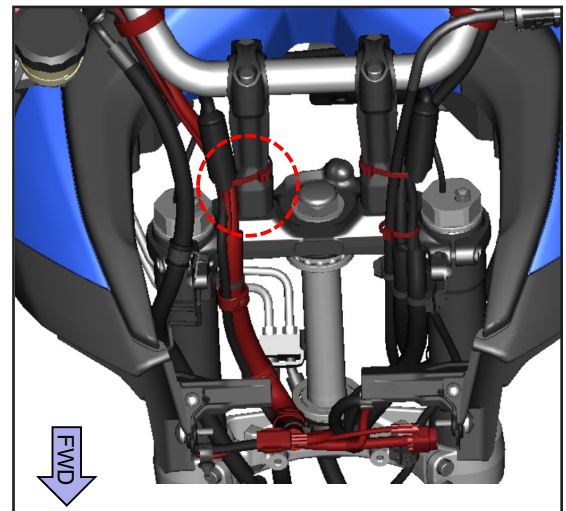

7. Secure the wires with the securing band on the right side of the handlebar ①.

TIP: Cable routing of (H)—Clamp switch handle lead wire (right), the front brake light switch lead wire, and grip warmer lead wire (right). With the buckle of the band facing up and the tip facing forward, clamp the band to the straight part of the handlebar.

- Switch handle lead wire (11)
- Front brake light switch lead wire (12)
- Grip warmer lead wire (18)
- Front (I)

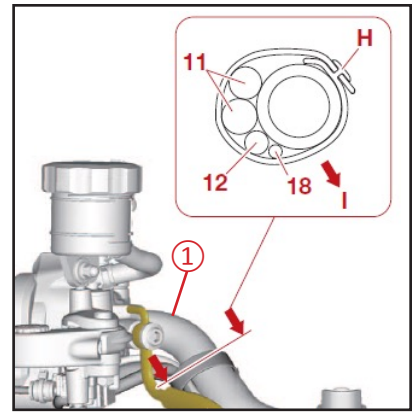

Headlight Assembly

Assemble the headlight in the reverse order of removal. Refer to “Detaching the Headlights.”

Exterior Parts Assembly

Install the exterior parts in the reverse order of the removal procedure. Refer to “Detaching Exterior Parts.”

Replacing the Grip End

Return to “Replacing the Grip End” on page 4 and follow the procedures.

Handlebar-Related Parts Assembly

Return to “Handlebar-Related Parts Assembly” and follow the procedures.

Procedural Checks:

- Check that the headlights operate properly.
- Check that the engine can be started normally.
- Check that the grip warmer operates normally.

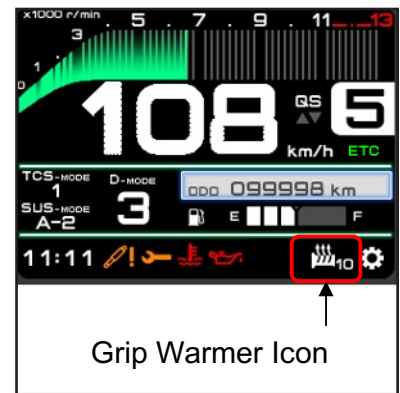

TIP: The grip warmer is only in use when the engine is running. Turn the wheel switch to hover over the grip warmer icon. Press the wheel switch to select the grip warmer icon.

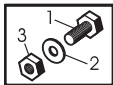

PARTS INFORMATION

IMPORTANT: Use the correct procedure for ordering warranty campaign parts (see Technical Bulletin MSA2021-001).

Part Number	Kit Part Name	Dealer Cost
90891-20417-00	END GRIP, MTT890D	\$8.35

Kit Part Contents

Part Number	Part Number Part Name	Qty
BAP-26246-00-00	END, GRIP	1



If the throttle tube is damaged, order the grip warmer kit below in addition to the end grip kit above:

Part Number	Kit Part Name	Dealer Cost
90891-20418-00	GRIP WARMER, SW., KIT MTT890D	\$131.08

Kit Part Contents

Part Number	Part Number Part Name	Qty
BAP-8270V-00-00	CORD SWITCH COMP.,1	1
1UA-82591-00-00	BAND	1



IDENTIFICATION PROCEDURE

After completing the procedure, make sure to properly record and submit the warranty claim for this campaign to ensure correct reimbursement and to update the vehicle's repair history in Yamaha's database.

The new grip end can be identified by the flange on the end. The old one does not have a flange.

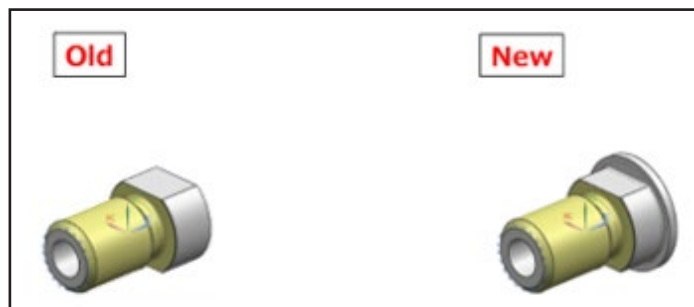



WARRANTY INFORMATION

The owner of each registered vehicle will receive a letter announcing this campaign. The customer's letter includes the Vehicle Identification Number and Recall Number.

The modification is authorized for all affected motorcycles, both sold and unsold, regardless of ownership or warranty status. You do not need the customer's letter to perform modification or to file for reimbursement.

Submit a Recall Claim as described below for parts and labor.

Inspect Throttle Tube Guide and Replace Grip End

Use Campaign Number **990156** and select "Inspect/Replace End Grip." The labor allowance is **0.3 hours**.

Replace Grip Warmer Switch and Grip End

If the throttle tube guide was broken and had to be replaced, use Campaign Number **990156** and select "Replace Throttle Grip SW Assy with End Grip." The labor allowance is **1.3 hours**.

To submit your Recall Claim on YDS, go to *Service > Warranty Claims / Authorization > Claims / Authorization > New*. Then, from the menu, select Recall / Service per Bulletin.

The screenshot shows the 'Add New Claim / Authorization' form. Under the 'New Claim / Service per Bulletin' section, the option 'Recall / Service per Bulletin' is selected and highlighted with a red box. Other options include 'Warranty / Y.E.S. Claim - If Issued under E100', 'Parts and ACC/Staffs Assistance Claim', 'Warranty Authorization', 'Warranty / Y.E.S. Authorization - If Repair is \$100 or more', 'Out of Warranty Authorization', 'Un-Registered / In-Valid for Authorization', 'Shipping Damage', and 'Shipping Damage Authorization - Pictures Required'. A 'CONTINUE' button is at the bottom right.

The screenshot shows the 'Add New Claim / Authorization' form for a 'Unit Recall/Service Campaign'. A red arrow points to the 'Campaign #' dropdown menu, with the text 'ENTER CAMPAIGN CODE (990156) HERE' written in red above it. The form includes fields for 'Primary ID', '(OR) VIN/HEM', 'Finish Date', and 'Miles or Hours'. There is a 'Please Select Repair Option' dropdown and a 'STEP 2 - ADD <<' button. A table with columns 'Primary ID', 'Finish Date', and 'Miles or Hours' is visible on the right. A 'STEP 3 - SUBMIT' button is at the bottom right.

If you have any questions about proper procedures for Factory Modification Campaigns, see Chapter 7 in your *Warranty and Y.E.S. Handbook* (LIT-11760-00-21).



YAMAHA MOTOR CORPORATION, U.S.A. 6555 Katella Avenue, Cypress, CA 90630-5101 800-962-7926

IMPORTANT SAFETY RECALL NOTICE

This notice applies to your motorcycle or scooter, VIN xxxxxxxxxxxxxxxxxx Model:

March 17, 2022
990156

Dear Yamaha Owner:

Yamaha Motor Corporation, U.S.A. has decided that a defect that relates to motor vehicle safety exists in certain 2021 model MTT9GTM/MC (Tracer 9 GT) motorcycles. Our records indicate that you own the affected vehicle shown above.

The reason for this recall: In affected motorcycles, if the throttle grip is used to pull up a motorcycle that has fallen on its side, the throttle grip tube may break at the guide due to the excessive lateral pulling force applied to it because of an improperly designed grip end. If the guide is broken, the broken portion could restrict throttle movement during operation, which could result in loss of control and a crash with severe injury or death.

What Yamaha and your dealer will do: Your authorized Yamaha dealer will inspect the throttle grip tube to see if it is broken. If it is not broken, they will replace the grip end with a new one that is properly designed. If the throttle grip tube is broken, they will replace the entire right throttle grip/handlebar switch with grip warmer before installing the new grip end. The grip end replacement takes approximately 20 minutes to perform. If the throttle tube is broken, it will take approximately an hour and 20 minutes to replace the throttle grip/handlebar switch and the grip end. In either case, your dealer may need to have your motorcycle longer than the time stated, depending upon scheduling. **There will be no charge to you for either procedure.**

What you should do now: Please call your Yamaha dealer to make a service appointment to have this procedure performed. At that same time, you can find out how long they expect to keep your vehicle for this service. Remember to take this letter with you when you take in your vehicle.

You should not operate your affected motorcycle, shown above, other than to take it to a dealer, until this inspection and modification is performed. If your motorcycle ever fell over and was lifted using the handlebar, contact your dealer or Yamaha if you need assistance in having it towed or otherwise transported to your service appointment.

If you are unable to return to the Yamaha dealer who sold you the vehicle, this service will be performed by any authorized Yamaha Motorcycle dealer. For the name of a dealer near you, call 1-800-88-YAMAHA or visit the Yamaha web site at www.yamaha-motor.com.

If you have had this repair performed before you received this letter, you may be entitled to receive reimbursement for the cost of obtaining a pre-notification remedy of the problem associated with this repair. For more information, contact Yamaha Customer Relations at 1-800-962-7926.

Be aware that certain 2021 model Tracer 9 GT motorcycles are also affected by a Safety Recall regarding the ECU. If yours is affected, you will get a second letter from Yamaha. Have your dealer confirm if your motorcycle is affected by both recalls and perform them at the same time for your convenience.

Federal regulations require that any vehicle lessor receiving this recall notice must forward a copy of this notice to the lessee within 10 days.

If you need help: If, after contacting your dealership, you have questions or concerns which the dealership is unable to answer, please write to:
Yamaha Motor Corporation, U.S.A.
Customer Relations Department
P.O. Box 6555
Cypress, CA 90630
Or call: 1-800-962-7926

If, after contacting Yamaha Customer Relations, you are still not satisfied that we have done our best to remedy the situation without charge and within a reasonable time, you may submit a written complaint to the Administrator, National Highway Traffic Safety Administration, 1200 New Jersey Avenue, SE., Washington, DC 20590; or call the Auto Safety Hotline at 1-888-327-4236 (TTY: 1-800-424-9153); or go to <http://www.safercar.gov>. Refer to NHTSA recall number 22V-110.

If you no longer own this Yamaha: If you have sold your Tracer 9 GT to another party, please call us toll-free at with the name and address of the new owner, along with the Vehicle Identification Number shown above your name on this letter.

We're sorry to cause you any inconvenience, but we are sincerely concerned about your safety and continued satisfaction with our products. Thank you for giving your attention to this important matter.

Sincerely,
Motorsports Service Support
Yamaha Motor Corporation, U.S.A.