



David J. Johnson  
 Director  
 Service Engineering Operations  
 Ford Customer Service Division

Ford Motor Company  
 P. O. Box 1904  
 Dearborn, Michigan 48121

April 7, 2022

**TO:** All U.S. Ford and Lincoln Dealers

**SUBJECT: NEW VEHICLE DEMONSTRATION / DELIVERY HOLD -  
 Safety Recall 21S56 – Supplement #4**

Certain 2021 - 2022 Model Year F-150 Vehicles Equipped with Crew Cab, 145" Wheelbase, 4x4, 302a & Above Option Package, and One-Piece Aluminum Driveshaft  
 Loose/Sagging Underbody Insulators

**AFFECTED VEHICLES**

Vehicle	Model Year	Assembly Plant	Build Dates
F-150	2021	Dearborn (DTP)	January 10, 2020 through November 20, 2021
F-150	2021	Kansas City (KCAP)	February 17, 2020 through October 19, 2021
F-150	2022	Dearborn (DTP)	October 29, 2021 through November 6, 2021
F-150	2022	Kansas City (KCAP)	October 13, 2021 through October 13, 2021

The eleventh VIN position is the assembly plant code.

- F - Dearborn Assembly (Dearborn, Michigan) = DTP
- K - Kansas City Assembly (Claycomo, Missouri) = KCAP

Affected vehicles are identified in OASIS and FSA VIN Lists.

**New! REASON FOR THIS SUPPLEMENT**

- Updated repair procedure for HEV vehicles.
- Updated labor operations/times and parts available for repairing Hybrid vehicles.
- Updated interim labor operation times when driveshafts are back-ordered.
- Updated inspection/replacement criteria for driveshafts.
- Due to continued back-orders on driveshafts, the rental deadline has been extended to June 30, 2022.
- Seed stock will continue for a few more weeks, then switch over to VIN-Specific Part Orders through the SSSC.

**REASON FOR THIS SAFETY RECALL**

In some of the affected vehicles, underbody insulators may loosen and contact the aluminum driveshaft, resulting in marking or scoring of the driveshaft. Over time, the aluminum driveshaft may fracture, which can result in loss of motive power while driving, unintended vehicle movement while the vehicle is in park if the parking brake is not applied, and secondary damage to surrounding components. A fractured driveshaft may also contact the ground which may cause loss of control of the vehicle while driving. A fractured driveshaft increases the risk of injury or crash.

**SERVICE ACTION**

Before demonstrating or delivering any new in-stock vehicles involved in this recall, dealers are to secure both the driver and passenger-side underbody insulators and inspect the driveshaft, fuel vapor lines and electrical connectors for damage and repair as required. This service must be performed on all affected vehicles at no charge to the vehicle owner.

## **OWNER NOTIFICATION MAILING SCHEDULE**

Owner letters were mailed the week of January 31, 2022. Dealers should repair any affected vehicles that arrive at their dealerships, whether or not the customer has received a letter.

### **PLEASE NOTE:**

**Federal law requires dealers to complete this recall service before a new vehicle is delivered to the buyer or lessee. Violation of this requirement by a dealer could result in a civil penalty of up to \$21,000 per vehicle. Correct all vehicles in your new vehicle inventory before delivery.**

### **New! ATTACHMENTS**

Attachment I: Administrative Information

*Attachment II: Labor Allowances and Parts Ordering Information*

*Attachment III: Technical Information - Gas Engines manufactured at Dearborn Truck*

*Attachment IV: Technical Information - Diesel Engine*

*Attachment V: Technical Information - Hybrid Engine*

*Attachment VI: Technical Information - Gas Engines manufactured at Kansas City*

Owner Notification Letter

### **QUESTIONS & ASSISTANCE**

For questions and assistance, contact the Special Service Support Center (SSSC) via the SSSC Web Contact Site. The SSSC Web Contact Site can be accessed through the Professional Technician System (PTS) website using the SSSC link listed at the bottom of the OASIS VIN report screen or listed under the SSSC tab.

Sincerely,



David J. Johnson

**NEW VEHICLE DEMONSTRATION / DELIVERY HOLD - Safety Recall 21S56 – Supplement #4**  
Certain 2021 - 2022 Model Year F-150 Vehicles Equipped with Crew Cab, 145" Wheelbase, 4x4, 302a &  
Above Option Package, and One-Piece Aluminum Driveshaft  
Loose/Sagging Underbody Insulators

**OASIS ACTIVATION**

OASIS was activated on December 17, 2021.

**FSA VIN LISTS ACTIVATION**

FSA VIN Lists were available through <https://web.fsavinlists.dealerconnection.com> on December 17, 2021. Owner names and addresses were available on February 18, 2022.

**NOTE:** Your FSA VIN Lists may contain owner names and addresses obtained from motor vehicle registration records. The use of such motor vehicle registration data for any purpose other than in connection with this recall is a violation of law in several states, provinces, and countries. Accordingly, you must limit the use of this listing to the follow-up necessary to complete this recall.

**SOLD VEHICLES**

- Ford has not issued instructions to stop selling/delivering or driving used vehicles under this safety recall. Owners should contact their dealer for an appointment to have their vehicles remedied as soon as practicable. Owners can continue to safely drive their vehicles.
- Immediately contact any of your affected customers whose vehicles are not on your VIN list but are identified in OASIS. Give the customer a copy of the Owner Notification Letter (when available) and schedule a service date.
- Correct other affected vehicles identified in OASIS which are brought to your dealership.
- Dealers are to prioritize repairs of customer vehicles over repairs of new and used vehicle inventory.

**STOCK VEHICLES**

- Correct all affected units in your new vehicle inventory before delivery.
- Use OASIS to identify any affected vehicles in your used vehicle inventory.

**DEALER-OPERATED RENTAL VEHICLES**

The Fixing America's Surface Transportation (FAST) Act law effective June 2016 prohibits a rental company from selling, renting or leasing vehicles subject to a safety or compliance recall. Please consult your legal counsel for legal advice.

**TITLE BRANDED / SALVAGED VEHICLES**

Affected title branded and salvaged vehicles are eligible for this recall.

**OWNER REFUNDS**

Refunds are not approved for this program.

**NEW VEHICLE DEMONSTRATION / DELIVERY HOLD - Safety Recall 21S56 – Supplement #4**  
 Certain 2021 - 2022 Model Year F-150 Vehicles Equipped with Crew Cab, 145" Wheelbase, 4x4, 302a &  
 Above Option Package, and One-Piece Aluminum Driveshaft  
 Loose/Sagging Underbody Insulators

**New!** **RENTAL VEHICLES**

- **PASS INSPECTION:** Vehicles that pass the applicable driveshaft, fuel systems, and electrical inspections are **NOT** affected and are not approved for rental vehicles. Refer to the 21S56 technical instructions for additional information.
- **FAIL INSPECTION:** Vehicles that fail either the applicable driveshaft, fuel systems, or electrical inspections
  - **Parts are NOT available:**
    - ✓ Driveshaft, vapor line, or pigtail is on back-order.
    - ✓ PARTS ESCALATION PROCESS (Vehicle Off Road) process has been followed and COPIS ticket with VOR flagged has been submitted.
    - ✓ Prior approval is required from the SSSC, submit contact type long-term rental for consideration and approval if appropriate.
- **A ten-digit prior-approval code is required from the SSSC for rental vehicles,** a new approval code is required from SSSC every 30 days.
- If rental vehicles are needed beyond **June 30, 2022**, dealers will have to contact SSSC for an extension.
- Approval for all rental vehicles for this program will end on **June 30, 2022**.
- Follow Extended Service Plan (ESP) guidelines for dollar amounts. Prior approval is required from the SSSC.

**ADDITIONAL REPAIR (LABOR TIME AND/OR PARTS)**

Additional repairs identified as necessary to complete the FSA should be managed as follows:

- For related damage and access time requirements, refer to the Warranty and Policy Manual / Section 6 – Ford & Lincoln Program Policies / General Information & Special Circumstances for FSA's / Related Damage.
- For vehicles within new vehicle bumper-to-bumper warranty coverage, no SSSC approval is required, although related damage must be on a separate repair line with the "Related Damage" radio button checked.
  - Ford vehicles – 3 years or 36,000 miles
- For vehicles outside new vehicle bumper-to-bumper warranty coverage, submit an Approval Request to the SSSC Web Contact Site prior to completing the repair.

**NEW VEHICLE DEMONSTRATION / DELIVERY HOLD - Safety Recall 21S56 – Supplement #4**  
Certain 2021 - 2022 Model Year F-150 Vehicles Equipped with Crew Cab, 145" Wheelbase, 4x4, 302a &  
Above Option Package, and One-Piece Aluminum Driveshaft  
Loose/Sagging Underbody Insulators

**CLAIMS PREPARATION AND SUBMISSION**

- **Claim Entry:** Enter claims using Dealer Management System (DMS) or One Warranty Solution (OWS) online.
  - When entering claims, select claim type 31: Field Service Action. The FSA number (21S56) is the sub code.
  - For additional claims preparation and submission information, refer to the Recall and Customer Satisfaction Program (CSP) Repairs in the OWS User Guide.
- **Related Damage/Additional labor and/or parts:** Must be claimed as Related Damage on a separate repair line from the FSA with same claim type and sub code as described in Claim Entry above.

**IMPORTANT:** Click the Related Damage Indicator radio button.
- **Rentals:** For rental vehicle claiming, follow Extended Service Plan (ESP) guidelines for dollar amounts. Enter the total amount of the rental expense under Miscellaneous Expense code RENTAL.
- Provision for Misc. Expense: Provision for Misc. Expense: Washers and Loctite 243 as needed.
  - Program Code: 21S56
  - Misc. Expense: OTHER
  - Amount: Actual cost up to \$15.00

**NEW VEHICLE DEMONSTRATION / DELIVERY HOLD - Safety Recall 21S56 – Supplement #4**  
 Certain 2021 - 2022 Model Year F-150 Vehicles Equipped with Crew Cab, 145" Wheelbase, 4x4, 302a &  
 Above Option Package, and One-Piece Aluminum Driveshaft  
 Loose/Sagging Underbody Insulators

**New!** **LABOR ALLOWANCES**

**Dearborn Truck Plant Build Dates** – Design change that removed underbody insulators from production

Passenger-Side Insulator 10/15/2021 and later

Driver-Side Insulator 11/19/2021 and later

1. Where was the vehicle manufactured?
  - a. Kansas City – see Attachment VI for correct Technical Instructions to complete repair.
  - b. Dearborn Truck - Proceed to step 2.
2. Passenger-Side:
  - a. What is the production date of the vehicle? \_\_\_\_\_
  - b. If production date = 10/15/2021 and later:
    - i. Passenger-side not present – follow technical instructions, per dealer bulletin claim 21S56B
3. Driver-Side:
  - a. What is the production date of the vehicle? \_\_\_\_\_
  - b. If production date = 11/19/2021 and later:
    - i. Driver-side not present - follow technical instructions, per dealer bulletin claim 21S56B
4. Both Passenger and Driver-side:
  - a. What is the production date of the vehicle? \_\_\_\_\_
  - b. If production date = 11/19/2021 and later:
    - i. If both passenger and driver-side not present – no repair is necessary, close recall – claim 21S56E with 0.3 hours.

**Kansas City Build Dates** - Design change that removed underbody insulators from production

Passenger-Side Insulator 10/18/2021 and later

Driver-Side Insulator 11/19/2021 and later

1. Where was the vehicle manufactured?
  - a. Dearborn Truck – see either Attachment III, IV, or V for correct Technical Instructions to complete repair.
  - b. Kansas City - Proceed to step 2.
2. Passenger-Side:
  - a. What is the production date of the vehicle? \_\_\_\_\_
  - b. If production date = 10/18/2021 and later:
    - i. Passenger-side not present – follow technical instructions, per dealer bulletin claim 21S56B
3. Driver-Side:
  - a. What is the production date of the vehicle? \_\_\_\_\_
  - b. If production date = 11/19/2021 and later:
    - i. Driver-side not present - follow technical instructions, per dealer bulletin claim 21S56B
4. Both Passenger and Driver-side:
  - a. What is the production date of the vehicle? \_\_\_\_\_
  - b. If production date = 11/19/2021 and later:
    - i. If both passenger and driver-side not present – no repair is necessary, close recall – claim 21S56E with 0.3 hours.

**NEW VEHICLE DEMONSTRATION / DELIVERY HOLD - Safety Recall 21S56 – Supplement #4**  
 Certain 2021 - 2022 Model Year F-150 Vehicles Equipped with Crew Cab, 145" Wheelbase, 4x4, 302a &  
 Above Option Package, and One-Piece Aluminum Driveshaft  
 Loose/Sagging Underbody Insulators

**New!** LABOR ALLOWANCES (continued)

Description	Labor Operation	Labor Time
<p><b><u>Parts are available to complete repair:</u></b></p> <ol style="list-style-type: none"> <li>Retrieve DTC's (gas engine only)</li> <li>Inspect both underbody insulators for contact with driveshaft, fuel vapor lines for gas engine and coolant sensor wiring for hybrid.</li> <li>Drill 2 holes (KCAP vehicles) or 5 holes (DTP vehicles) and install corresponding # of rivets and washers to secure insulators.</li> <li>Clean four driveshaft bolts and apply</li> </ol> <p>Note: Includes time to remove, and install or replace driveshaft</p> <p><i>Note: Hybrid Vehicles should claim labor operation code 21S56H or 21S56HH</i></p>	21S56B	0.9 Hours
<p><b><u>Driveshaft Replacement Necessary, part on back-order (this will not close recall):</u></b></p> <ol style="list-style-type: none"> <li>Retrieve DTC's (gas engine only)</li> <li>Inspect both underbody insulators for contact with driveshaft, fuel vapor lines for gas engine and coolant sensor wiring for hybrid.</li> <li>Drill 2 holes (KCAP vehicles) or 5 holes (DTP vehicles) and install corresponding # of rivets and washers to secure insulators.</li> <li>Clean four driveshaft bolts and apply</li> </ol> <p>Note: Includes time to remove, and install or replace driveshaft</p> <p><i>Note: Hybrid Vehicles should claim labor operation code 21S56H or 21S56HH</i></p>	21S56BB	0.9 Hours
<p>Gas engine only:</p> <ul style="list-style-type: none"> <li>Diagnose DTC P0442 and/or P0456 (PPT and inspection)</li> <li>Remove fuel tank for additional inspection (if necessary)</li> <li>Repair damage to vapor lines caused by the underbody insulator</li> </ul>	MT21S56C	Up to 2.0 Hours

**NEW VEHICLE DEMONSTRATION / DELIVERY HOLD - Safety Recall 21S56 – Supplement #4**  
 Certain 2021 - 2022 Model Year F-150 Vehicles Equipped with Crew Cab, 145" Wheelbase, 4x4, 302a &  
 Above Option Package, and One-Piece Aluminum Driveshaft  
 Loose/Sagging Underbody Insulators

**New!** **LABOR ALLOWANCES (continued)**

Hybrid – Repair damaged coolant sensor wiring cause by underbody insulator	MT21S56D	Up to 1.0 Hour
Time allowed to submit photos (required for driveshaft, vapor lines, electrical, underbody insulators, and other related damage)	21S56ZZ	0.2 Hours
If both underbody insulators are missing with build dates listed above, no repair necessary, close recall.	21S56E	0.3 Hours
Raptor Vehicles – extra time to remove muffler and tail pipe to install rivets	21S56G	0.5 Hours
<p><b><u>Parts are available to complete repair:</u></b>  <b>Hybrid -- Inspect drive shaft, remove drive shaft, remove under shield/clean, install one rivet, install drive shaft, and install/tape patch in interior of the vehicle</b>  <b>(can only be claimed with 21S56E, 21S56J, MT21S56D, 21S56ZZ)</b></p>	21S56H	1.5 Hours
<p><b><u>Driveshaft Replacement Necessary, part on back-order (this will not close recall):</u></b>  <b>Hybrid -- Inspect drive shaft, remove drive shaft, remove under shield/clean, install one rivet, install drive shaft, and install/tape patch in interior of the vehicle</b>  <b>(can only be claimed with 21S56E, 21S56J, MT21S56D, 21S56ZZ)</b></p>	21S56HH	1.5 Hours
<p><b>Hybrid Vehicles equipped with rear interior storage box Only</b>  <b>- Extra time to remove and install storage box if equipped</b>  <b>(can only be claimed with 21S56E, 21S56H, MT21S56D, 21S56ZZ)</b></p> <p><b>NOTE: Photo of rear interior storage box in vehicle must be attached to SSSC contact to claim this labor operation code</b></p>	21S56J	0.2 Hours
<p><b>All - Vehicle returns for driveshaft replacement</b>  <b>(part on back-order, COPIS ticket submitted, VOR flagged, SSSC 10 digit approval code required)</b></p>	21S56K	0.4 Hours



**NEW VEHICLE DEMONSTRATION / DELIVERY HOLD - Safety Recall 21S56 – Supplement #4**  
 Certain 2021 - 2022 Model Year F-150 Vehicles Equipped with Crew Cab, 145" Wheelbase, 4x4, 302a &  
 Above Option Package, and One-Piece Aluminum Driveshaft  
 Loose/Sagging Underbody Insulators

**New! PARTS REQUIREMENTS / ORDERING INFORMATION**

**Video Instruction:**

Review the following video clips before ordering parts or attempting to repair a vehicle:

<https://bcove.video/3rdmqR0>. *This video does not include the updated HEV repair procedure.*

**SSSC Web Contact Site:**

**Parts are not yet available to repair all vehicles. Until parts are available to repair all vehicles, dealers may only order parts and repair vehicles, which are customer-owned vehicles currently in the dealership and unsold vehicles with a signed sales contract.**

- To place an order for the following parts, submit a VIN-specific Part Order contact via the SSSC Web Contact Site - three or more photos as required per the technical instructions.
  1. Door label with VIN
  2. Odometer showing mileage of vehicle
  3. *Review the updated technical instructions and provide photos as requested for each step the driveshaft fails the inspection process.*
- Any unsold vehicles must include a copy of the signed sales contract.

**Driveshaft - Only replace the driveshaft if marks are present per the technical instructions.**

Part Number	Description	Order Quantity
*-4602-*	Driveshaft (part number varies by vehicle – use Ford ECat to identify the specific part number by VIN)	As Required

Dealers will be notified via a DOES II communication if circumstances warrant a change in part supply strategy and when open ordering resumes.

NOTE: The Driveshaft flange to pinion flange bolt part number N800594-S100 has been removed from the parts list for this program, and may be reused. Refer to the 21S56 Technical Information on updated instructions for thread cleaning and application of thread adhesive.

**New! Seed Stock:**

*Seed stock will continue for a few more weeks, then switch over to VIN-Specific Part Orders through the SSSC. Continue to monitor the FSA landing page and also DOES II communications.*

To ensure an equitable distribution of service parts, all the rivet part-numbers listed below will be seed stocked (to dealers with one or more VINs assigned to their dealership).

1. Effective immediately, rivets are available only through the seed stock program. SSSC will not be accepting orders for rivets until the seed stock program is complete.
2. Due to current supply-chain constraints, dealers will receive seed-stock beginning in mid-to-late February. Timing of the second and sequential seed-stocks will follow as parts are available.
3. The quantity shipped to each dealer will be equal to a percentage of the vehicles assigned to them.

Dealers will need to access <https://web.fsavinlists.dealerconnection.com> to determine the total number of affected vehicles assigned to their dealership.

**NOTE:** If a dealership wishes to discontinue their seed stock, contact the SSSC via the SSSC Web Contact Site. Please note that removing a dealership P&A Code from this seed stock program is a permanent action.

**NEW VEHICLE DEMONSTRATION / DELIVERY HOLD - Safety Recall 21S56 – Supplement #4**  
 Certain 2021 - 2022 Model Year F-150 Vehicles Equipped with Crew Cab, 145" Wheelbase, 4x4, 302a &  
 Above Option Package, and One-Piece Aluminum Driveshaft  
 Loose/Sagging Underbody Insulators

Dealers will be notified via a DOES II communication if circumstances warrant a change in part supply strategy and when open ordering resumes.

Rivet Part Number's	Description	Order Quantity	Claim Quantity
Any of the following part numbers may be used: • W702554-S900 • W702554-S900C • W702554-S437 • W708777-S900 • W708777-S900C • W705297-S417 • W705297-S300 • W719880-S417	Rivets (Pack of 4, 5 needed per DTP vehicles, 2 needed per KCAP vehicles)  NOTE: Part numbers ending in S900C are packages of 100	2 DTP	5 Rivets
		1 KCAP	2 Rivets

**Order the chemicals/fluids below through normal order processing channels:**

Repair	Part Number	Description	Order Quantity	Claim Quantity
All	PM-13-A or Equivalent (use OSP)	Motorcraft Anti-Corrosion Coating (16 fl. Oz per container, applied to 5 rivets liberally, ½ Container per repair)	1	<i>As Required</i>
All	TA-2-B or Equivalent (use OSP)	Motorcraft Seam Sealer (9.5 fl. Oz per container, applied to 5 rivets liberally, 1 per vehicle)	1	1
Driveshaft Replacement	XG-1-E1	Motorcraft® Premium Long-Life Grease	1	As Required
Driveshaft Replacement	XT-10-QLVC	MERCON® LV Automatic Transmission Fluid (12 per case, 1 Quart bottle required)	1	1 Quart

To guarantee the shortest delivery time, an emergency order for parts must be placed.

**Obtain the parts below locally:**

Part Number	Description	Quantity Needed
Obtain Locally	Zinc coated steel or Aluminum washers, ¼ inch ID, 2-inch OD, Thickness 2mm (Max).	5 needed per <u>DTP</u> Vehicle Claim as Misc. Other
		2 needed per <u>KCAP</u> Vehicle Claim as Misc. Other
Obtain Locally	LOCTITE 243 Blue Medium Strength Threadlocker or equivalent – Specification WSK-M2G349-A7	1 tube needed per vehicle Claim as Misc. Other

**NEW VEHICLE DEMONSTRATION / DELIVERY HOLD - Safety Recall 21S56 – Supplement #4**  
Certain 2021 - 2022 Model Year F-150 Vehicles Equipped with Crew Cab, 145" Wheelbase, 4x4, 302a &  
Above Option Package, and One-Piece Aluminum Driveshaft  
Loose/Sagging Underbody Insulators

**DEALER PRICE**

For latest prices, refer to DOES II.

**PARTS RETENTION, RETURN, & SCRAPPING**

Follow the provisions of the Warranty and Policy Manual, Section 1 - WARRANTY PARTS RETENTION AND RETURN POLICIES. If a replaced part receives a scrap disposition, the part must be scrapped in accordance with all applicable local, state and federal environmental protection and hazardous material regulations. Federal law prohibits selling motor vehicle parts or components that are under safety, compliance, or emissions recall.

**EXCESS STOCK RETURN**

Excess stock returned for credit must have been purchased from Ford Customer Service Division in accordance with Policy Procedure Bulletin 4000.

**REPLACED FSA PARTS INSPECTION AND SIGN OFF**

Effective March 1<sup>st</sup> 2021 all parts replaced as part of an FSA repair with a repair order open date of March 1<sup>st</sup> 2021 or later must be inspected and signed off on the repair order by a member of your dealers fixed operations management team or an employee the task has been delegated to. If the task is to be delegated to a non-management employee, the employee needs to be someone other than the technician who completed the repair and needs to understand the importance of completing this task consistently and accurately.

- All parts replaced as part of an FSA repair should be returned to the parts department following the Warranty Parts Retention and Return Policies.
- Inspect the replaced parts to verify the FSA repair was completed.
- If the FSA repair is found to be complete, the designated employee signs the repair order line or parts return stamp area (electronic or hand signed) for the FSA repair indicating the parts were inspected and validated to have been replaced.
- After the parts have been inspected, they should be handled based on the guidance in the parts status report in the Online Warranty System (Hold, Return, CORE, Scrap, etc.).
- This process is subject to review during warranty audits for FSA repairs with a repair order open date of March 1<sup>st</sup>, 2021 or later. Any eligible FSA claims requiring parts replacement, found not to have been inspected and signed off during a warranty audit will be subject to chargeback and consideration for enrollment into the Dealer Incomplete Recall Repair Process.

**Note:** Other approvals (electronic or handwritten) for add-on repair lines, dealer owned vehicle repairs, and repeat repairs do not qualify as FSA parts inspection approvals. The post repair FSA parts inspection process (electronic or handwritten) is independent from other warranty approval requirements. The approval by the designated employee implies that the FSA parts were found to be replaced and must be able to be clearly identified on the Repair Order. If multiple FSA's require approval on a single Repair Order, each applicable occurrence will require individual post repair approval by the designated employee.

**CERTAIN 2021-2022 MODEL YEAR F-150 VEHICLES EQUIPPED WITH A CREW CAB, 145" WHEELBASE, 4X4, 302A AND ABOVE OPTION PACKAGE, AND ONE-PIECE ALUMINUM DRIVESHAFT – LOOSE/SAGGING UNDERBODY INSULATORS**

**NEW ! SERVICE PROCEDURE**

**GAS ENGINES – VEHICLES MANUFACTURED AT DEARBORN TRUCK ASSEMBLY PLANT**

*Table Of Contents*

*Check for DTCs.....3*

*Inspection.....3*

*Driveshaft.....3*

*Zones 1, 3 and 4.....3*

*Zone 2.....5*

*Driver Side Insulator.....7*

*Vapor Line.....7*

*Securing Underbody Insulators.....9*

*Appendix A - Acceptable Photos.....13*

**Review the video link below before starting this repair procedure:**

 <https://bcove.video/3rdmqR0>

**Materials List**

Ruler/Scale/ <b>Straight Edge</b>	13 mm (1/2 in) Drill Stop	Small Brush
Drill	6.7 mm (17/64 in) Drill Bit	Marker
1/4" Rivet Gun	5.1 mm (13/64 in) Drill Bit – Rivet W719880-S417	Tape

**NOTE:** A ¼" air over hydraulic rivet gun was used for the service trials for this program, however a pneumatic rivet gun or a manual rivet gun may also be used. However, it may not be possible to access and properly secure the rivets into the floor pan using a manual rivet gun. It is important to always confirm the rivet is properly secured to the floor pan of the vehicle.



**NOTE:** The driver side insulator is located directly above the fuel tank.

**NOTE:** The passenger side insulator is located directly above the exhaust.

**NOTE:** Insulators are highlighted for illustration purposes only.

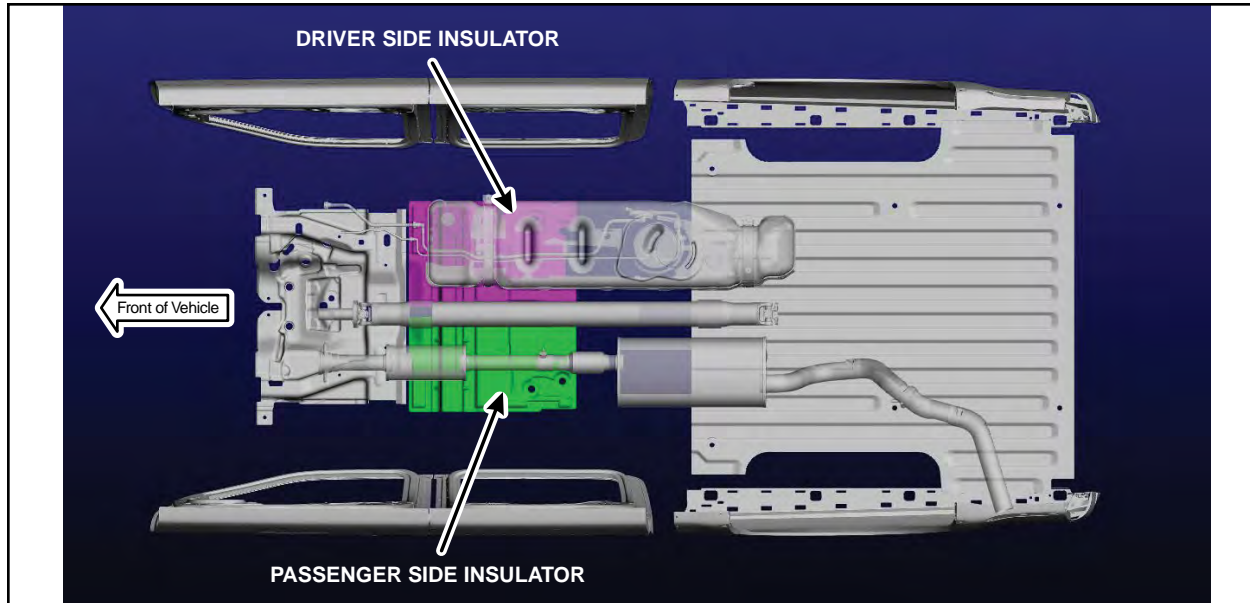

**FIGURE 1**

Dearborn Truck Plant Build Date - Design change that removed underbody insulators from production

Passenger Side Insulator	10/15/2021 and later
Driver Side Insulator	11/19/2021 and later

1. Where was the vehicle manufactured?

Kansas City – See Attachment VI for correct Technical Instructions to complete repair.  
Dearborn Truck – Proceed to step 2.

2. Is the production date of the vehicle 10/15/2021 and later?

Yes – If the passenger-side insulator is not present, follow technical instructions and per dealer bulletin claim 21S56B.  
No – Proceed to step 3.

3. Is the production date of the vehicle 11/19/2021 and later?

Yes – If the driver-side insulator is not present, follow technical instructions and per dealer bulletin claim 21S56B.  
– If both the passenger-side and driver-side insulators are not present, no repair is necessary, close recall and claim 21S56E with 0.3 hours.  
No – Proceed to step 4.

**NOTE:** Underbody Insulators should not be installed on vehicles where they were removed from production as indicated above.



### Check for DTCs

- Using the Ford Diagnostic and Repair System (FDRS), check the Powertrain Control Module (PCM) for DTCs. Are either of the following DTC's present in the PCM, P0442 and/or P0456?

Yes - Please follow Workshop Manual (WSM) procedures for pinpoint test HX in Section 303-13, then proceed to step 5.

No - Proceed to step 5.

### Inspection

- With the vehicle in NEUTRAL, position it on a hoist. Please follow Workshop Manual (WSM) procedures in Section 100-02.

- Is the vehicle a Raptor?

Yes – Proceed to step 7.

No – Proceed to step 8.

- Remove the muffler inlet pipe. Please follow WSM procedures in Section 309-00C then proceed to step 9.

- Remove the driveshaft. Please follow WSM procedures in Section 205-01.

**NOTE:** Do NOT discard the driveshaft flange to pinion flange bolts.

### Zones 1, 3 and 4

- Inspect Zones 1, 3 and 4 of the rear driveshaft for any marks caused by the front and/or rear edges of the passenger side insulator. Are there any marks present in Zones 1, 3 or 4? See Figure 2.**

**Yes – Proceed to step 10.**

**No – Proceed to step 12.**

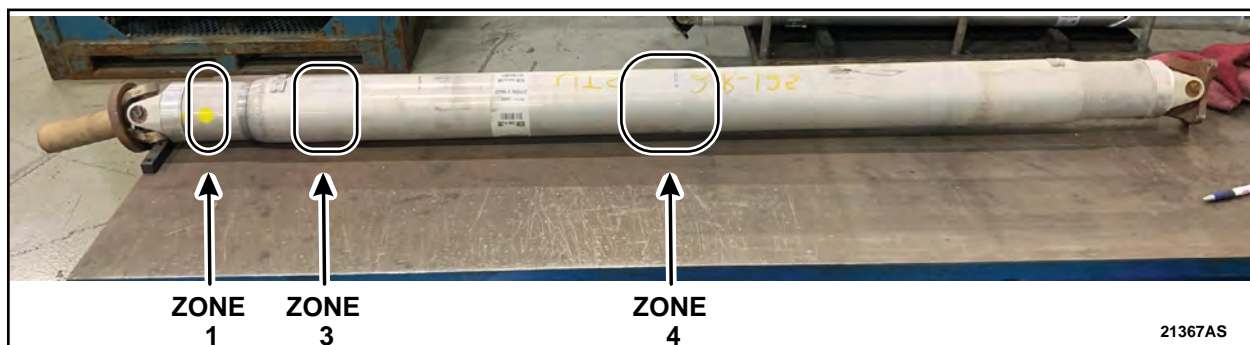

**FIGURE 2**





**10. What is the current odometer reading?**

**> 2,500 miles – Proceed to step 11.**

**< 2,500 miles – Proceed to step 12.**

**11. Place a straight edge along the driveshaft over the wear mark and attempt to fit a 0.018in (0.45mm) feeler gauge between the flat edge and the wear mark. Can the feeler gauge fit between the straight edge and anywhere along the wear mark? See Figures 3 and 4.**

**Yes – Does not pass inspection. Contact the SSSC and provide a picture of the driveshaft with the feeler gauge fitting between the straight edge and wear mark. Once approved, rear driveshaft replacement will be required, but do not install at this time. Proceed to step 14.**

**No – Passes inspection. Proceed to step 12.**

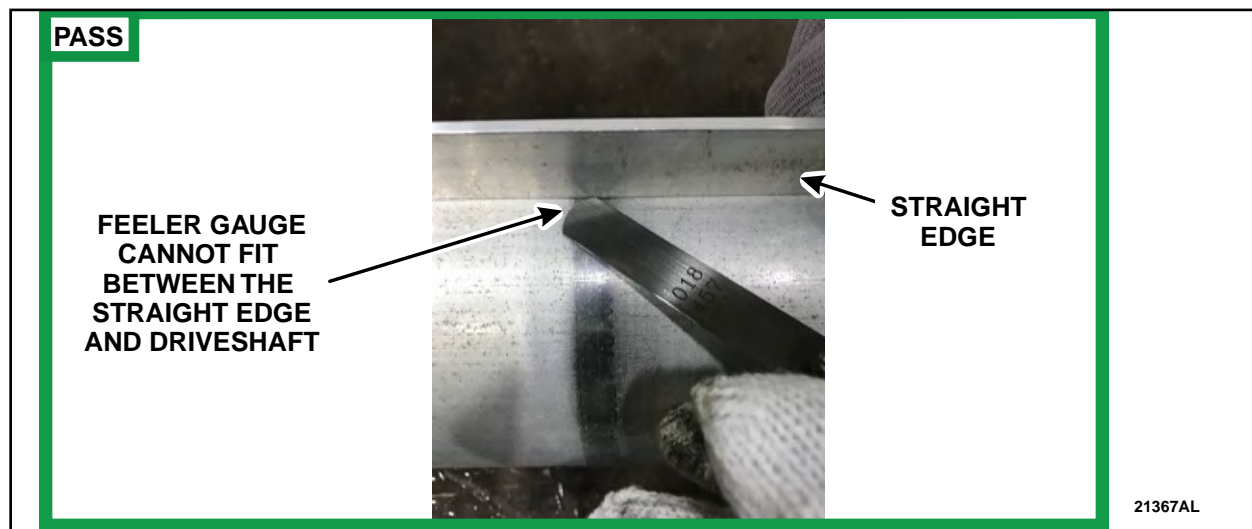

**FIGURE 3**

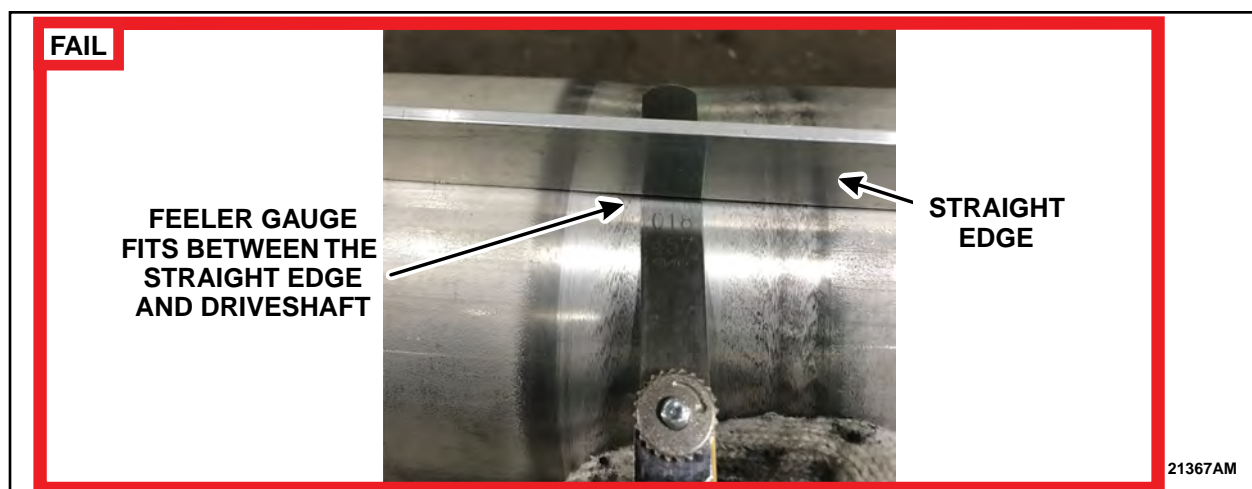

**FIGURE 4**



**Zone 2**

**12. Inspect Zone 2 (transition from larger tube diameter to smaller diameter section) of the driveshaft tube for any marks caused by the front edge of the passenger side insulator. Are there any marks present? See Figure 5.**

**Yes – Does not pass inspection. Proceed to step 13.**

**No – Passes inspection. Driveshaft may be reused. Proceed to step 14.**

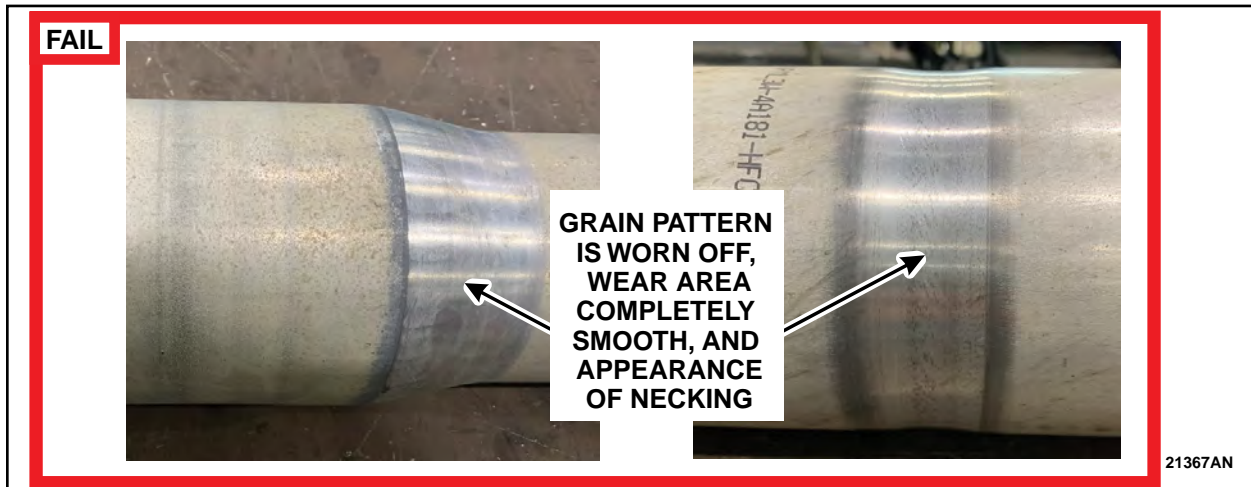

**FIGURE 5**

**13. Inspect the marks found on Zone 2. Is the aluminum tube surface grain pattern worn off, completely smooth, or have an appearance of necking? See Figures 6 through 9.**

**Yes – Does not pass inspection. Contact the SSSC and provide a picture of the driveshaft with the grain pattern worn off. Be sure to show a clear image of the grain pattern missing. Once approved, rear driveshaft replacement will be required, but do not install at this time. Proceed to step 14.**

**No – Passes inspection. Driveshaft may be reused. Proceed to step 14.**



**FIGURE 6**





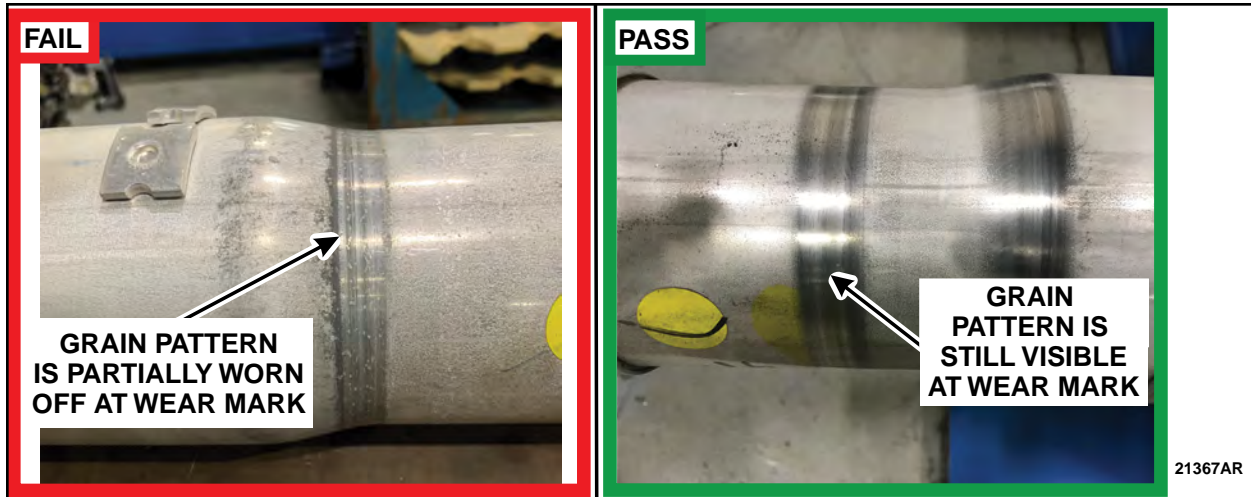

FIGURE 7

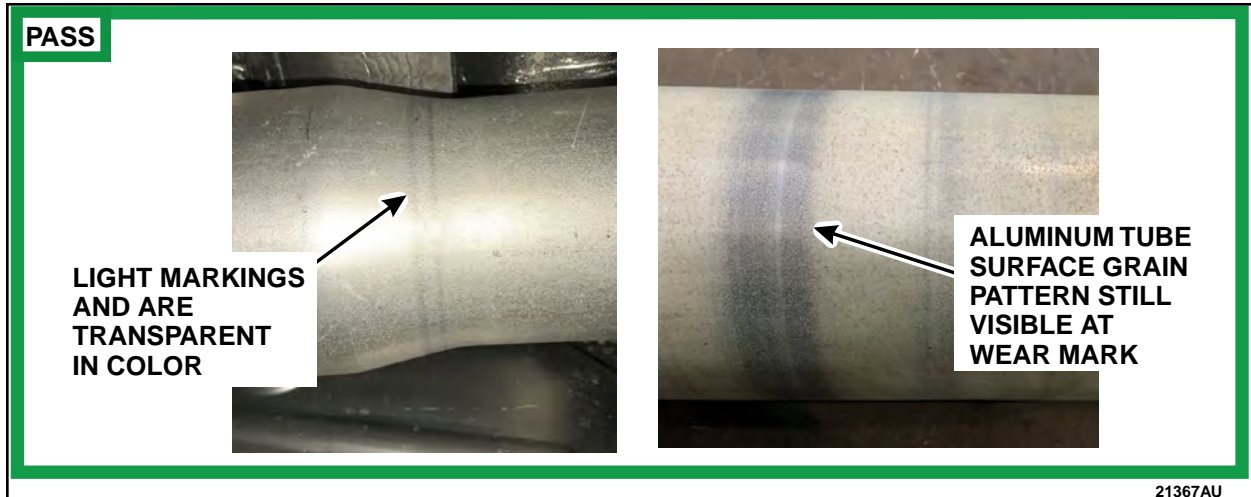

FIGURE 8



FIGURE 9



### Driver Side Insulator

14. Inspect the driver side insulator for any edges hanging down or touching the fuel tank. Is the insulator hanging down or touching the fuel tank? See Figure 10.

Yes – Does not pass inspection. Proceed to step 15.

No – Passes inspection. Proceed to step 17.

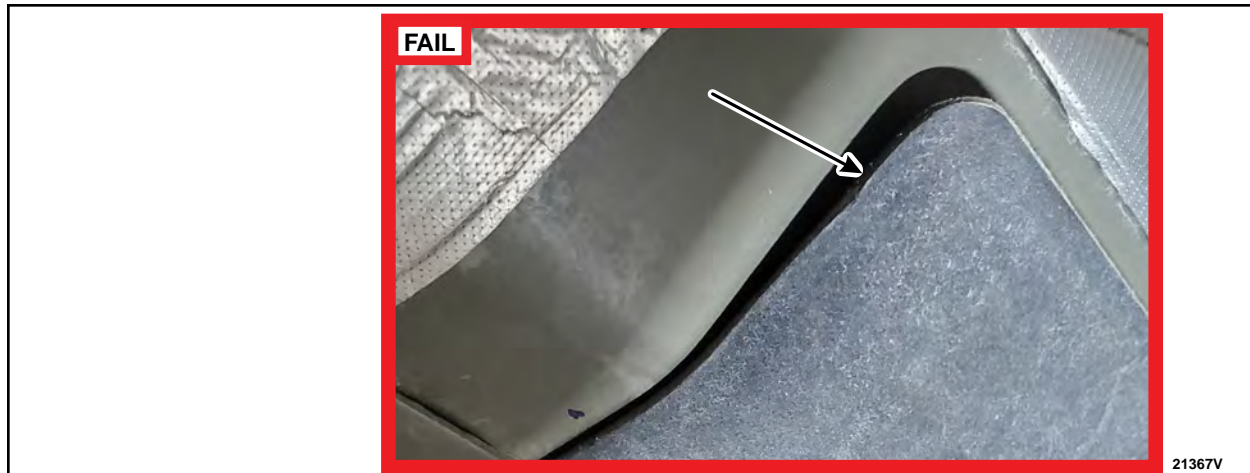

**FIGURE 10**

15. Remove the fuel tank to gain access to the vapor line. Please follow WSM procedures in Section 310-01.

16. Inspect the vapor line for any damage caused by the driver side insulator. Is there any damage to the line? See Figures 11 through 13.

Yes – Does not pass inspection. Replace the damaged line. Please follow WSM procedures in Section 310-01, then proceed to step 17.

No – Passes inspection. Proceed to step 17.

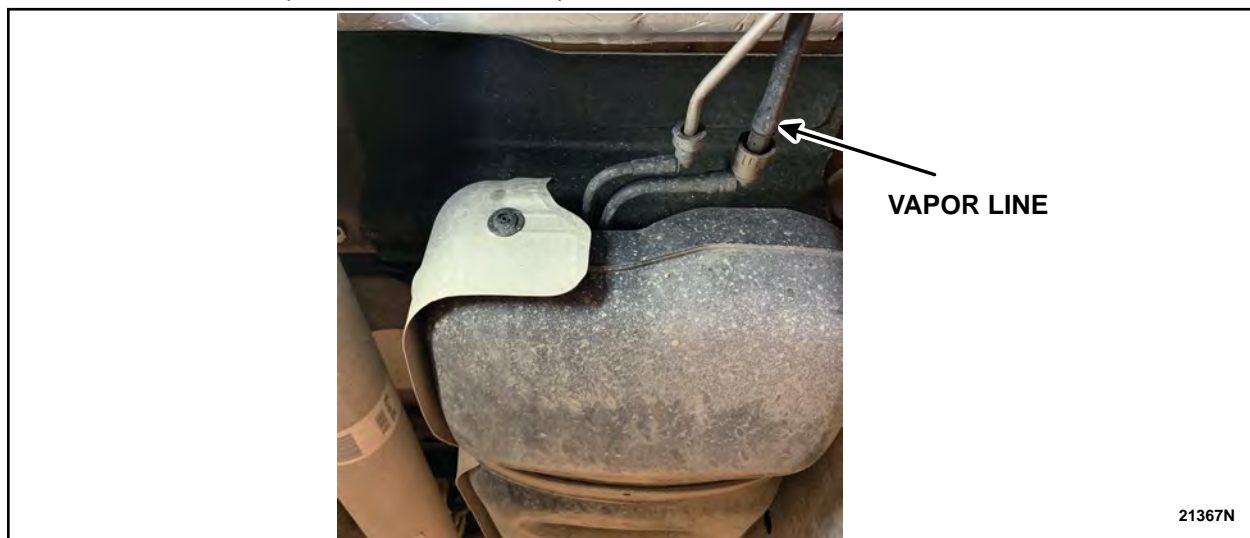

**FIGURE 11**



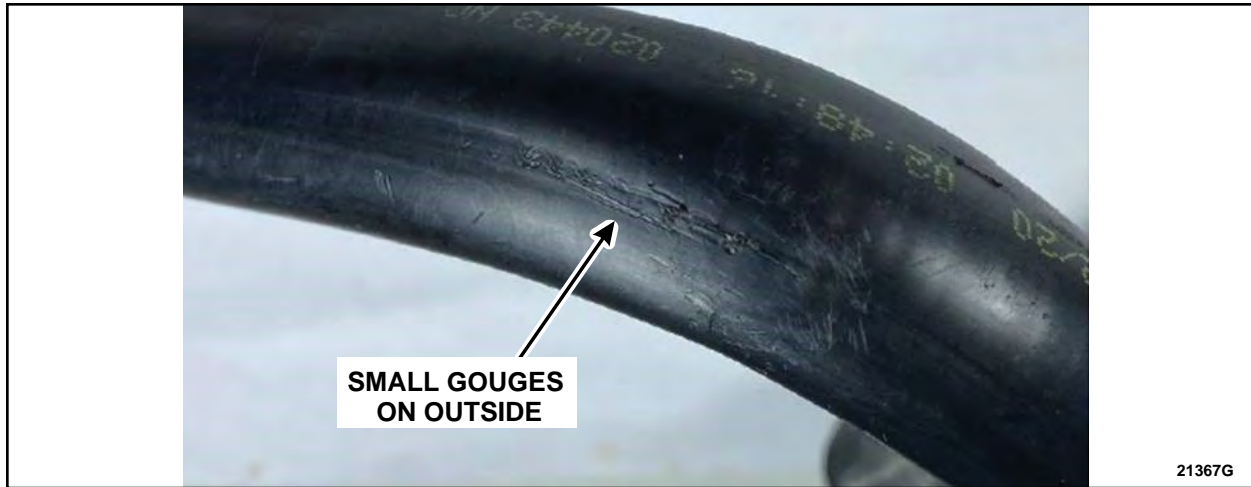

FIGURE 12

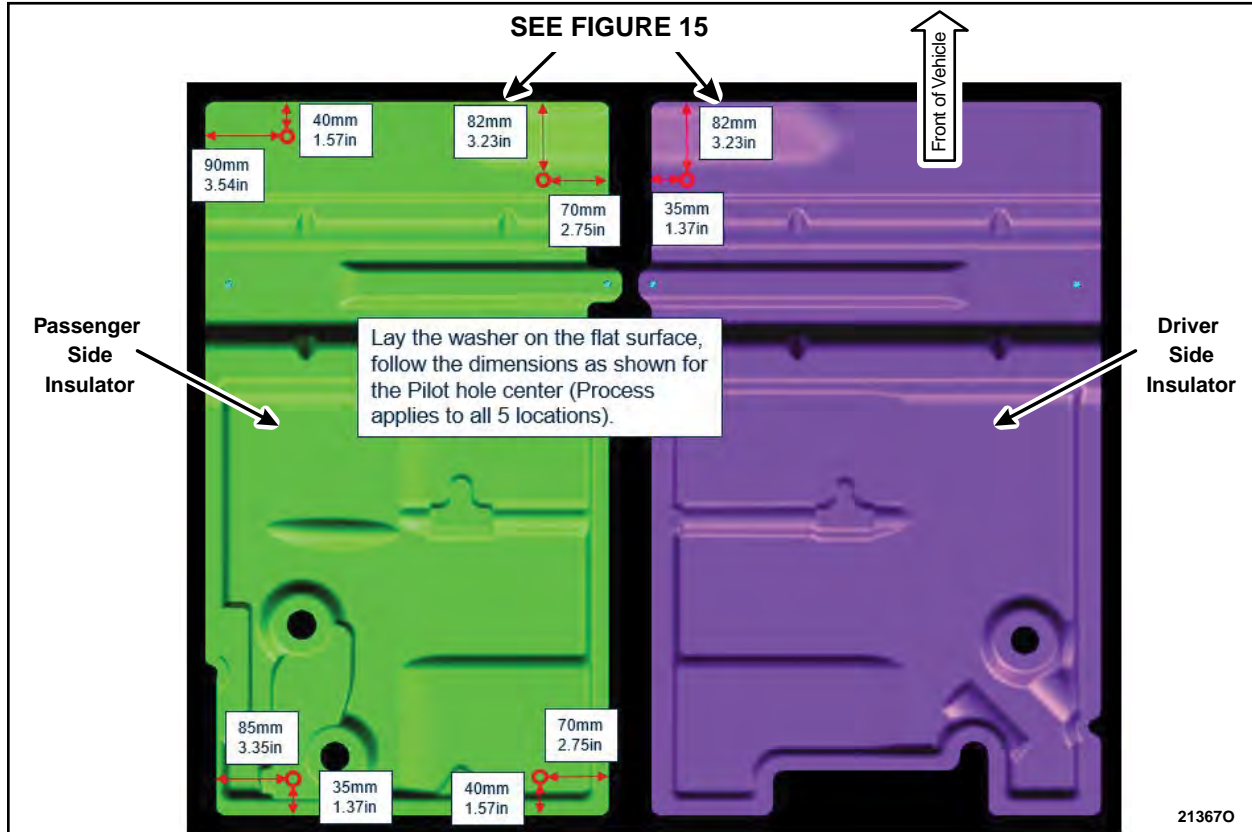

FIGURE 13



### Securing Underbody Insulators

17. Measure and mark the four locations on the passenger side insulator and mark the one location on the driver side insulator. See Figures 14 and 15.



**FIGURE 14**

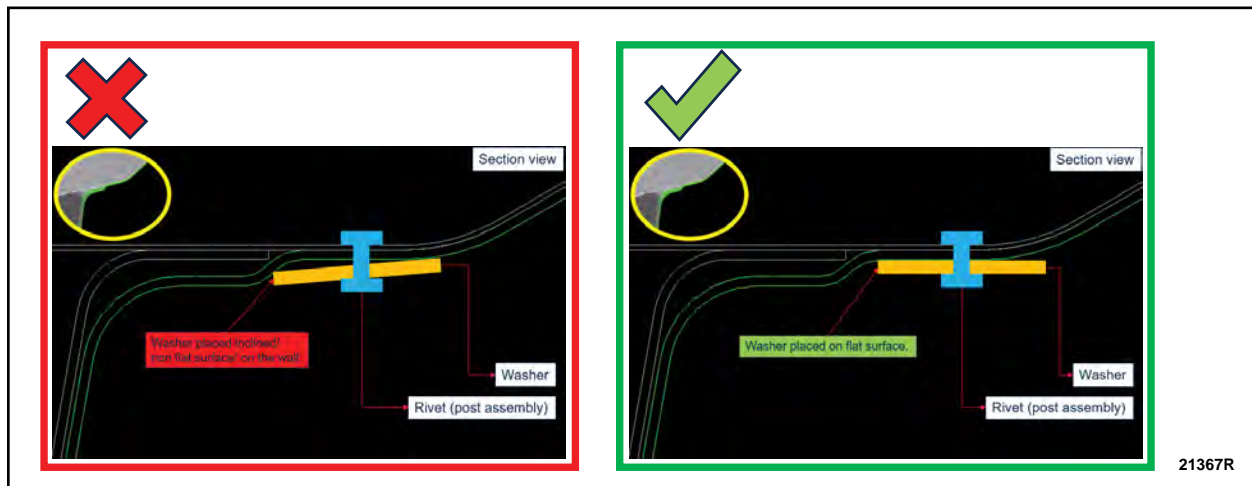

**FIGURE 15**





18. Use the 5.1 mm (13/64 in) drill bit for rivet part number W719880-S417 or the 6.7mm (17/64 in) drill bit for all other rivet part numbers to drill a hole through the insulator and into the floor. See Figure 16.

**NOTE:** Use the 13 mm (1/2 in) drill stop to ensure you do not drill through the carpet.



**FIGURE 16**

19. Repeat step 18 for the remaining four marked locations.
20. Using a small brush, apply a layer of the anti-corrosion coating to the edges of the newly drilled holes.
21. Install the washer onto the rivet. See Figure 17.

**NOTE:** All approved listed rivet part numbers may not look identical to the photos in the technical instructions.



**FIGURE 17**



22. Apply a thick layer of seam sealer to the rivet, and the backside of the washer. See Figure 18.



**FIGURE 18**

23. Using a 1/4" rivet gun, install the rivet and washer to the drilled hole. See Figure 19.

**NOTE:** To ensure the rivet is properly secured, apply as much force to the rivet gun as possible.

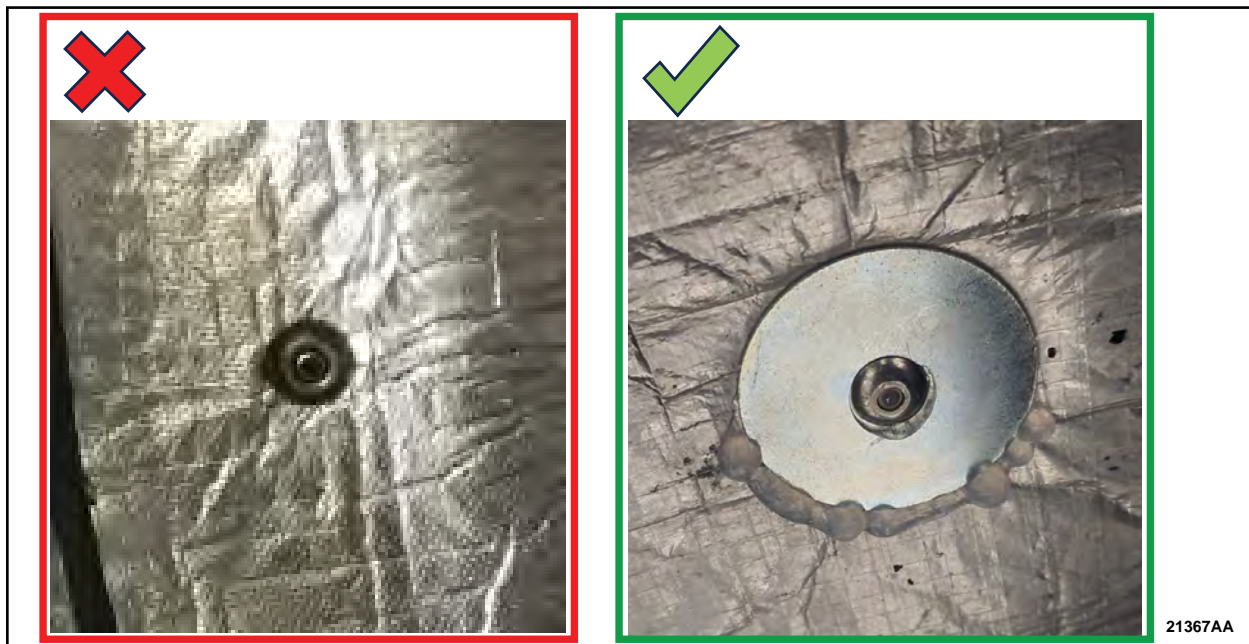

**FIGURE 19**

24. Attempt to move the washer/rivet to confirm it is properly secured.

25. Using a small brush, apply a layer of the anti-corrosion coating to the washer and rivet.

26. Repeat steps 21-25 for the remaining four drilled holes.



27. Install the fuel tank if it was removed in the inspection. Please follow WSM procedures in Section 310-01.
28. Using an air blow gun, remove any debris from threaded holes in axle flange. See Figure 20.

**NOTE:** Make sure that the mating faces are clean and free of foreign material.

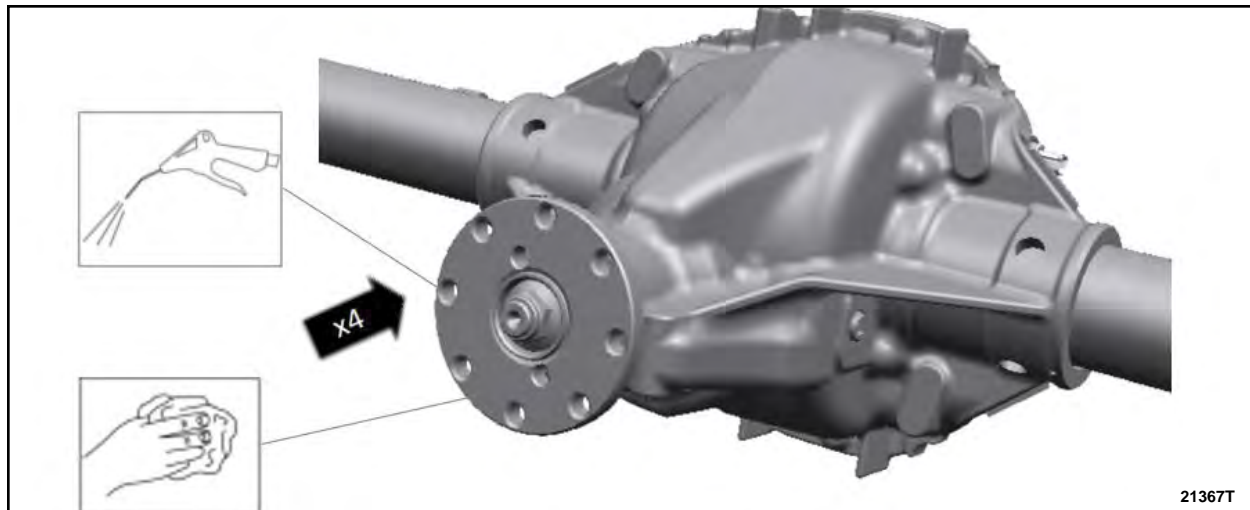

**FIGURE 20**

29. Inspect the original driveshaft flange to pinion flange bolts for rust in the threads and replace if rusted or damaged. Clean threads of the original driveshaft flange to pinion flange bolts with a wire brush and coat the threads with LOCTITE 243 Blue Medium Strength Threadlocker or equivalent. See Figure 21.

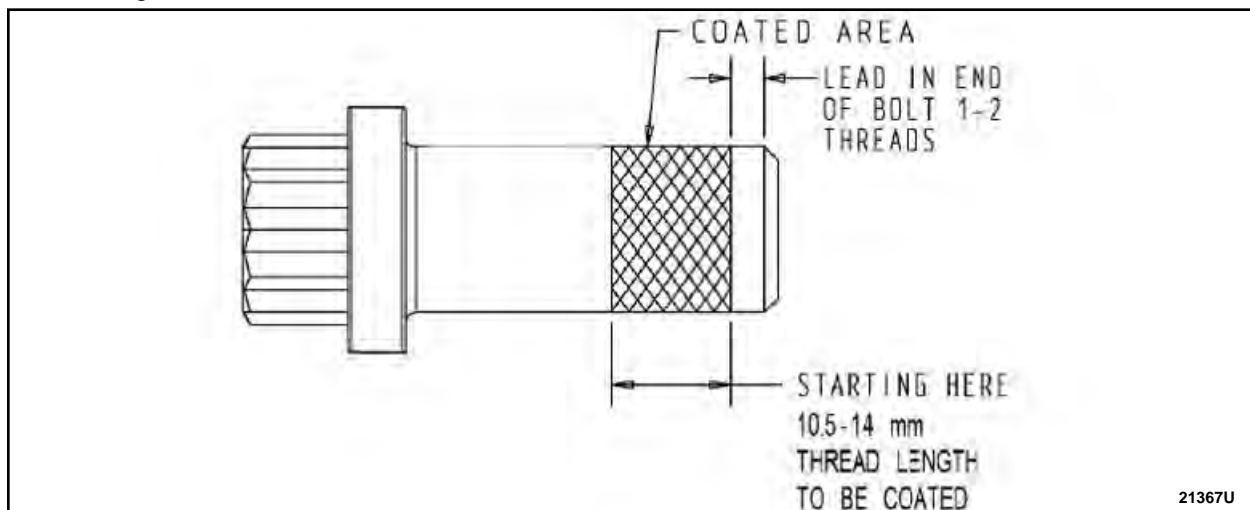

**FIGURE 21**

30. Install the driveshaft if it was removed in the inspection. Please follow WSM procedures in Section 205-01.
31. Install the muffler inlet pipe if it was removed in the inspection. Please follow WSM procedures in Section 309-00C.



Appendix A – Acceptable Photos



FIGURE 22

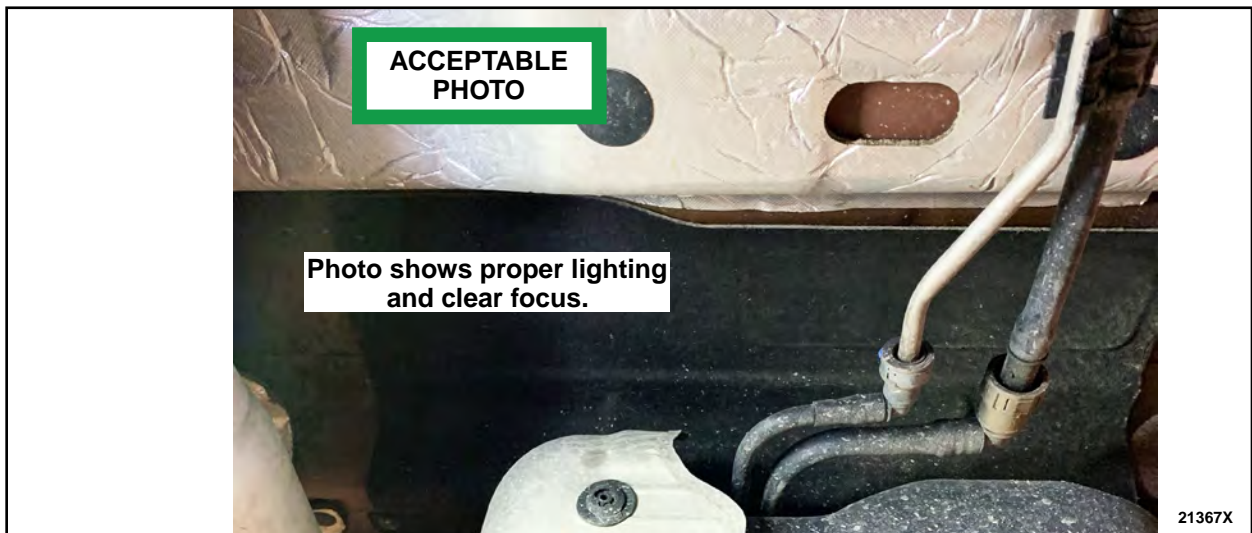

FIGURE 23





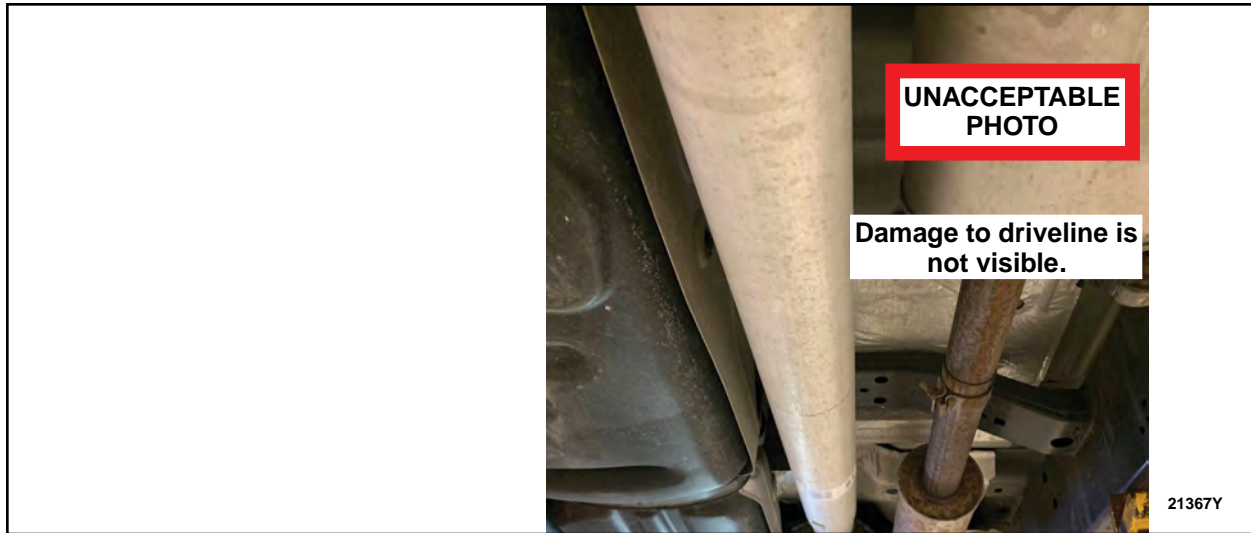

FIGURE 24



FIGURE 25



**CERTAIN 2021-2022 MODEL YEAR F-150 VEHICLES EQUIPPED WITH A CREW CAB, 145" WHEELBASE, 4X4, 302A AND ABOVE OPTION PACKAGE, AND ONE-PIECE ALUMINUM DRIVESHAFT – LOOSE/SAGGING UNDERBODY INSULATORS**

**NEW ! SERVICE PROCEDURE**

**DIESEL ENGINES**

*Table Of Contents*

*Inspection.....3*

*Driveshaft.....3*

*Zones 1, 3 and 4.....3*

*Zone 2.....5*

*Securing Underbody Insulators.....7*

*Appendix A - Acceptable Photos.....11*

**Review the video link below before starting this repair procedure:**

 <https://bcove.video/3rdmqR0>

**Materials List**

Ruler/Scale/ <b>Straight Edge</b>	13 mm (1/2 in) Drill Stop	Small Brush
Drill	6.7 mm (17/64 in) Drill Bit	Marker
1/4" Rivet Gun	5.1 mm (13/64 in) Drill Bit – Rivet W719880-S417	Tape

**NOTE:** A ¼” air over hydraulic rivet gun was used for the service trials for this program, however a pneumatic rivet gun or a manual rivet gun may also be used. However, it may not be possible to access and properly secure the rivets into the floor pan using a manual rivet gun. It is important to always confirm the rivet is properly secured to the floor pan of the vehicle.

**NOTE:** The driver side insulator is located directly above the fuel tank.

**NOTE:** The passenger side insulator is located directly above the exhaust.

**NOTE:** Insulators are highlighted for illustration purposes only.



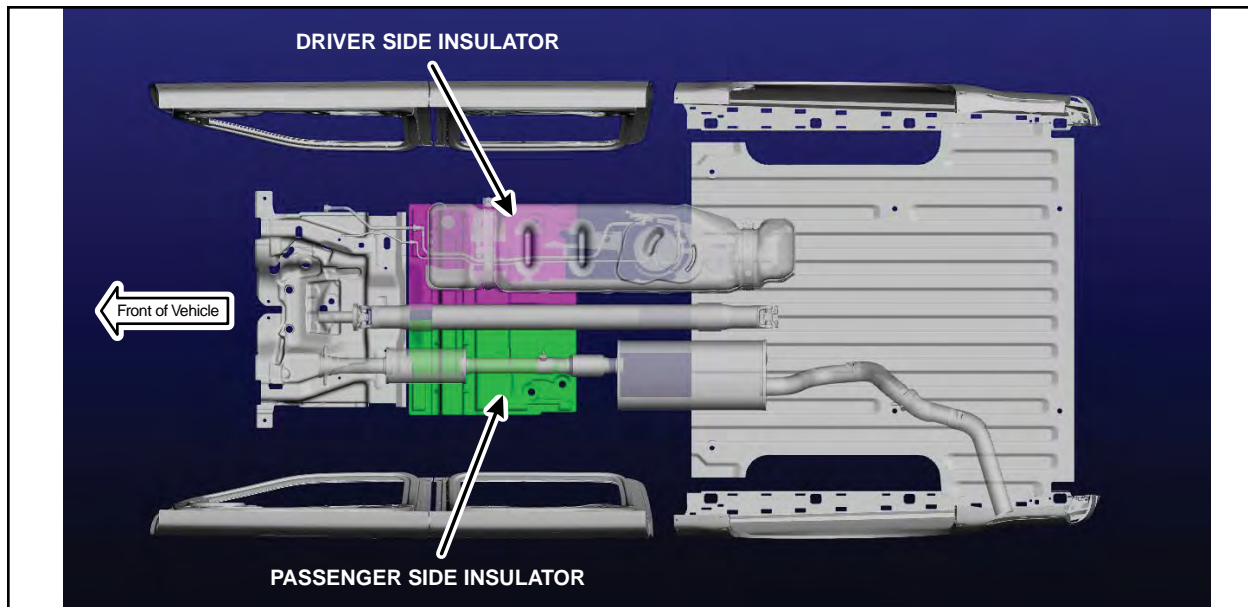

**FIGURE 1**

Dearborn Truck Plant Build Date - Design change that removed underbody insulators from production

Passenger Side Insulator	10/15/2021 and later
Driver Side Insulator	11/19/2021 and later

1. Where was the vehicle manufactured?

Kansas City – See Attachment VI for correct Technical Instructions to complete repair.  
Dearborn Truck – Proceed to step 2.

2. Is the production date of the vehicle 10/15/2021 and later?

Yes – If the passenger-side insulator is not present, follow technical instructions and per dealer bulletin claim 21S56B.  
No – Proceed to step 3.

3. Is the production date of the vehicle 11/19/2021 and later?

Yes – If the driver-side insulator is not present, follow technical instructions and per dealer bulletin claim 21S56B.  
– If both the passenger-side and driver-side insulators are not present, no repair is necessary, close recall and claim 21S56E with 0.3 hours.  
No – Proceed to step 4.

**NOTE:** Underbody Insulators should not be installed on vehicles where they were removed from production as indicated above.



## Inspection

4. With the vehicle in NEUTRAL, position it on a hoist. Please follow Workshop Manual (WSM) procedures in Section 100-02.
5. Remove the driveshaft. Please follow WSM procedures in Section 205-01.

**NOTE:** Do NOT discard the driveshaft flange to pinion flange bolts.

### Zones 1, 3 and 4

6. **Inspect Zones 1, 3 and 4 of the rear driveshaft for any marks caused by the front and/or rear edges of the passenger side insulator. Are there any marks present in Zones 1, 3 or 4? See Figure 2.**

**Yes – Proceed to step 7.**

**No – Proceed to step 9.**

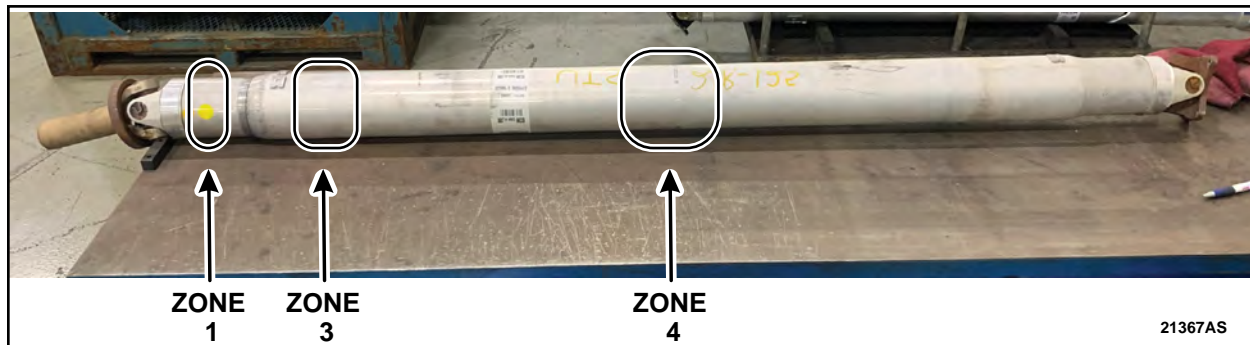

**FIGURE 2**

7. **What is the current odometer reading?**

**> 2,500 miles – Proceed to step 8.**

**< 2,500 miles – Proceed to step 9.**

8. **Place a straight edge along the driveshaft over the wear mark and attempt to fit a 0.018in (0.45mm) feeler gauge between the flat edge and the wear mark. Can the feeler gauge fit between the straight edge and anywhere along the wear mark? See Figures 3 and 4.**

**Yes – Does not pass inspection. Contact the SSSC and provide a picture of the driveshaft with the feeler gauge fitting between the straight edge and wear mark. Once approved, rear driveshaft replacement will be required, but do not install at this time. Proceed to step 11.**

**No – Passes inspection. Proceed to step 9.**



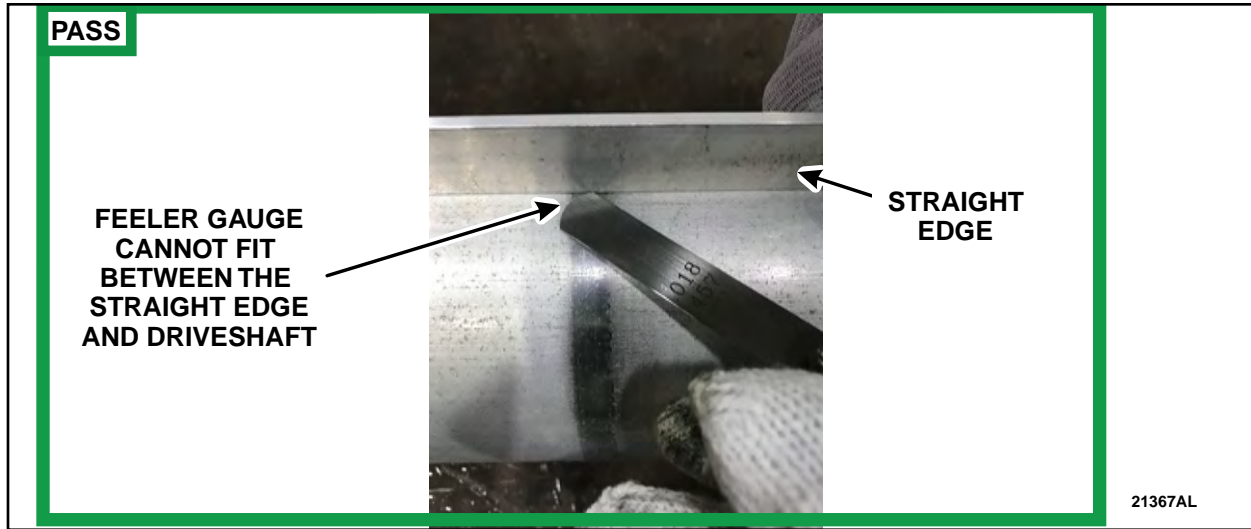

**FIGURE 3**

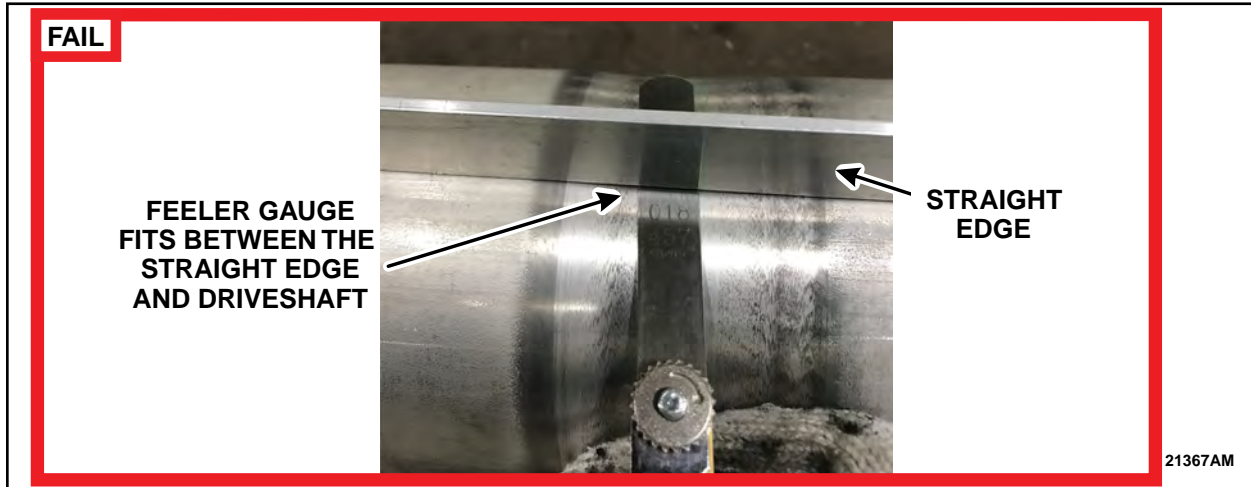

**FIGURE 4**





**Zone 2**

9. Inspect Zone 2 (transition from larger tube diameter to smaller diameter section) of the driveshaft tube for any marks caused by the front edge of the passenger side insulator. Are there any marks present? See Figure 5.

**Yes – Does not pass inspection. Proceed to step 10.**

**No – Passes inspection. Driveshaft may be reused. Proceed to step 11.**

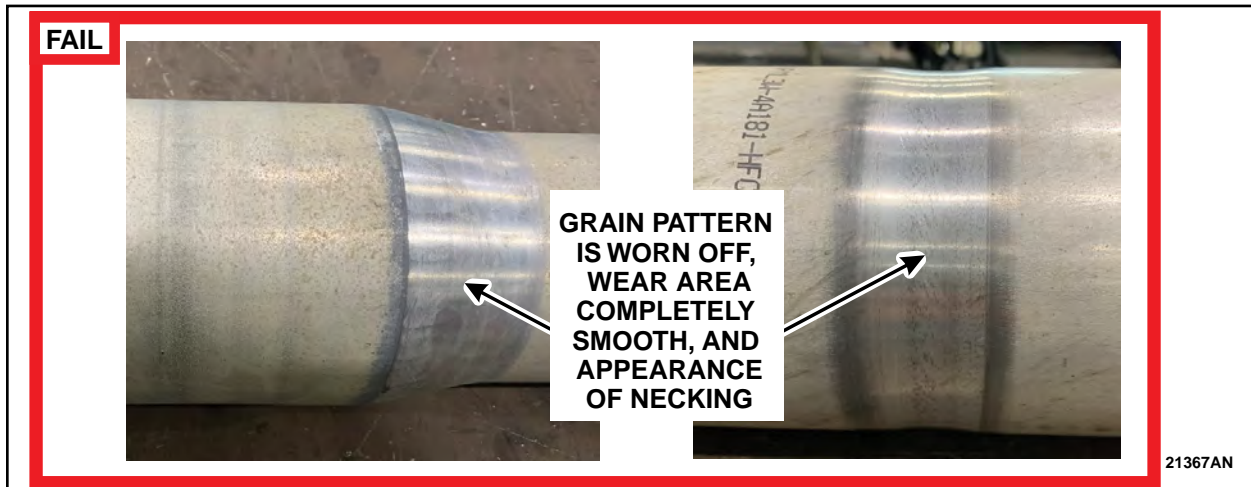

**FIGURE 5**

10. Inspect the marks found on Zone 2. Is the aluminum tube surface grain pattern worn off, completely smooth, or have an appearance of necking? See Figures 6 through 9.

**Yes – Does not pass inspection. Contact the SSSC and provide a picture of the driveshaft with the grain pattern worn off. Be sure to show a clear image of the grain pattern missing. Once approved, rear driveshaft replacement will be required, but do not install at this time. Proceed to step 11.**

**No – Passes inspection. Driveshaft may be reused. Proceed to step 11.**



**FIGURE 6**



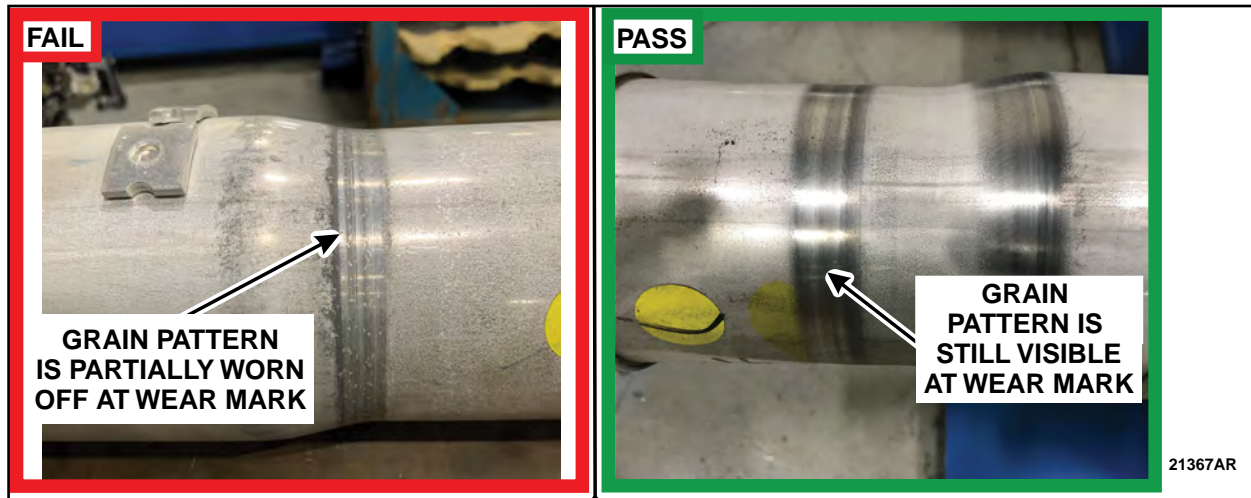

FIGURE 7

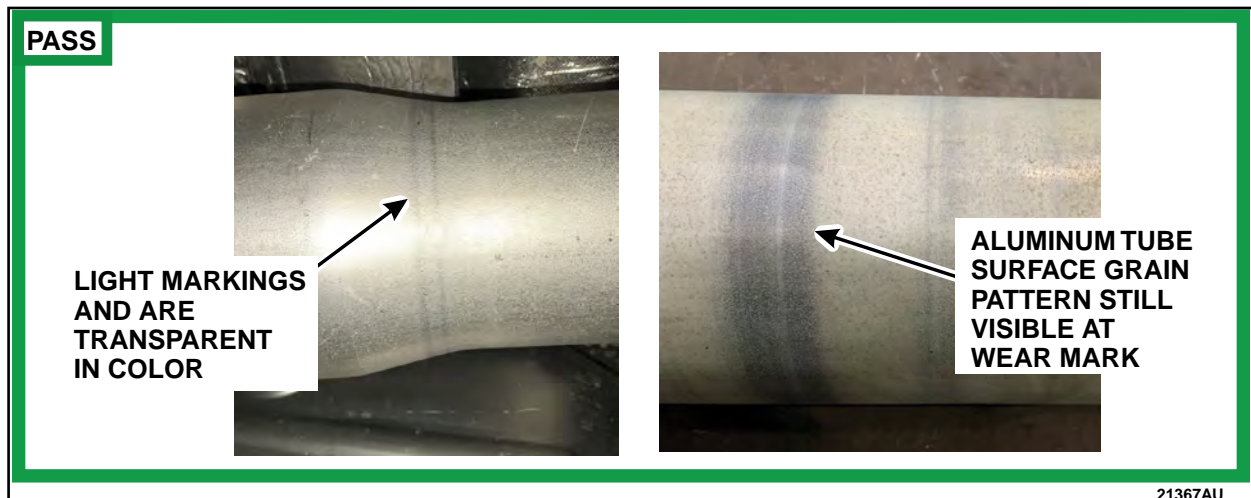

FIGURE 8

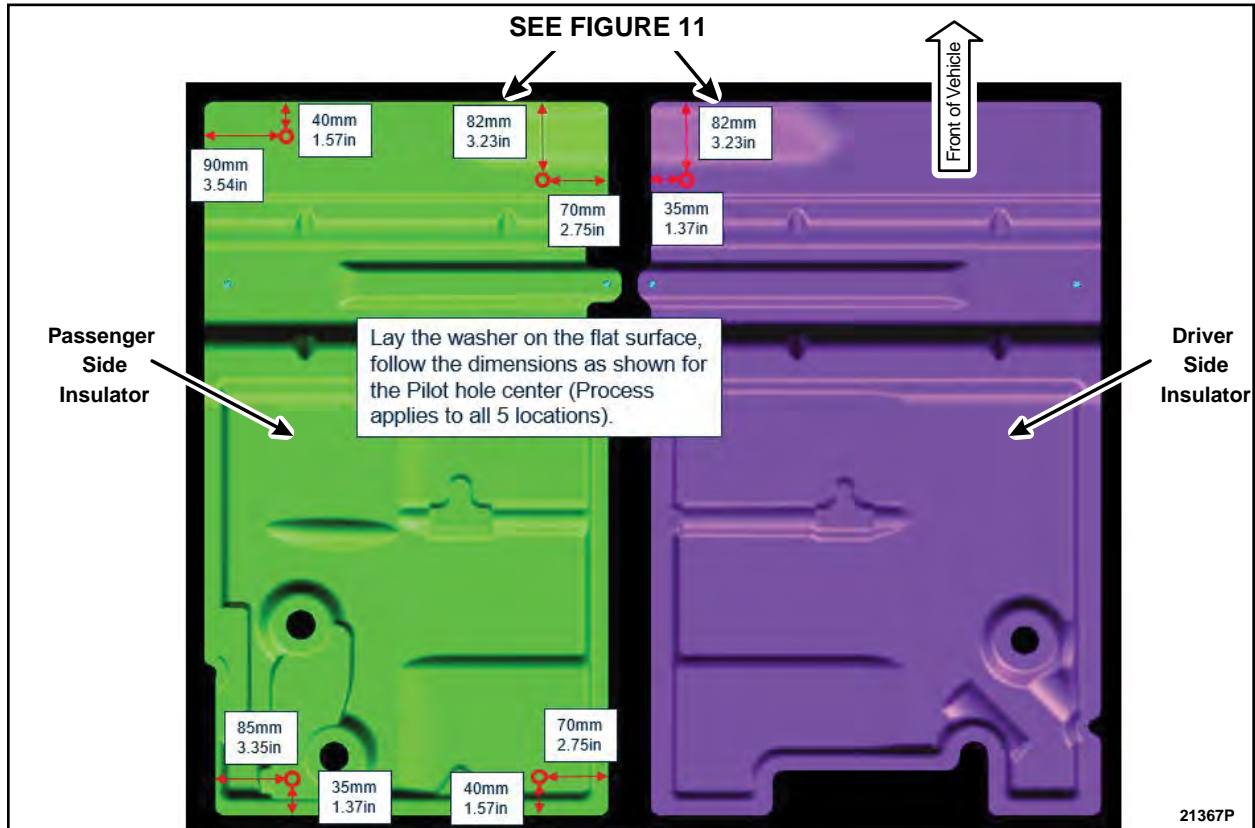

FIGURE 9



### Securing Underbody Insulators

11. Measure and mark the four locations on the passenger side insulator and mark the one location on the driver side insulator. See Figures 10 and 11.



**FIGURE 10**

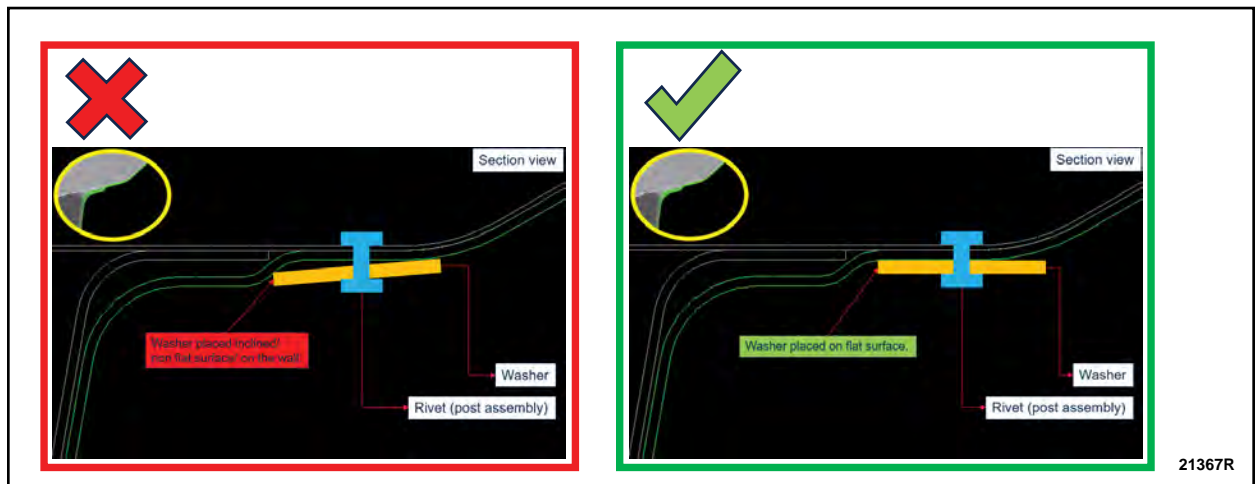

**FIGURE 11**





12. Use the 5.1 mm (13/64 in) drill bit for rivet part number W719880-S417 or the 6.7mm (17/64 in) drill bit for all other rivet part numbers to drill a hole through the insulator and into the floor. See Figure 12.

**NOTE:** Use the 13mm (1/2 in) drill stop to ensure you do not drill through the carpet.



**FIGURE 12**

13. Repeat step 12 for the remaining four marked locations.
14. Using a small brush, apply a layer of the anti-corrosion coating to the edges of the newly drilled holes.
15. Install the washer onto the rivet. See Figure 13.

**NOTE:** All approved listed rivet part numbers may not look identical to the photos in the technical instructions.



**FIGURE 13**



16. Apply a thick layer of seam sealer to the rivet, and the backside of the washer. See Figure 14.



**FIGURE 14**

17. Using a 1/4" rivet gun, install the rivet and washer to the drilled hole. See Figure 15.

**NOTE:** To ensure the rivet is properly secured, apply as much force to the rivet gun as possible.

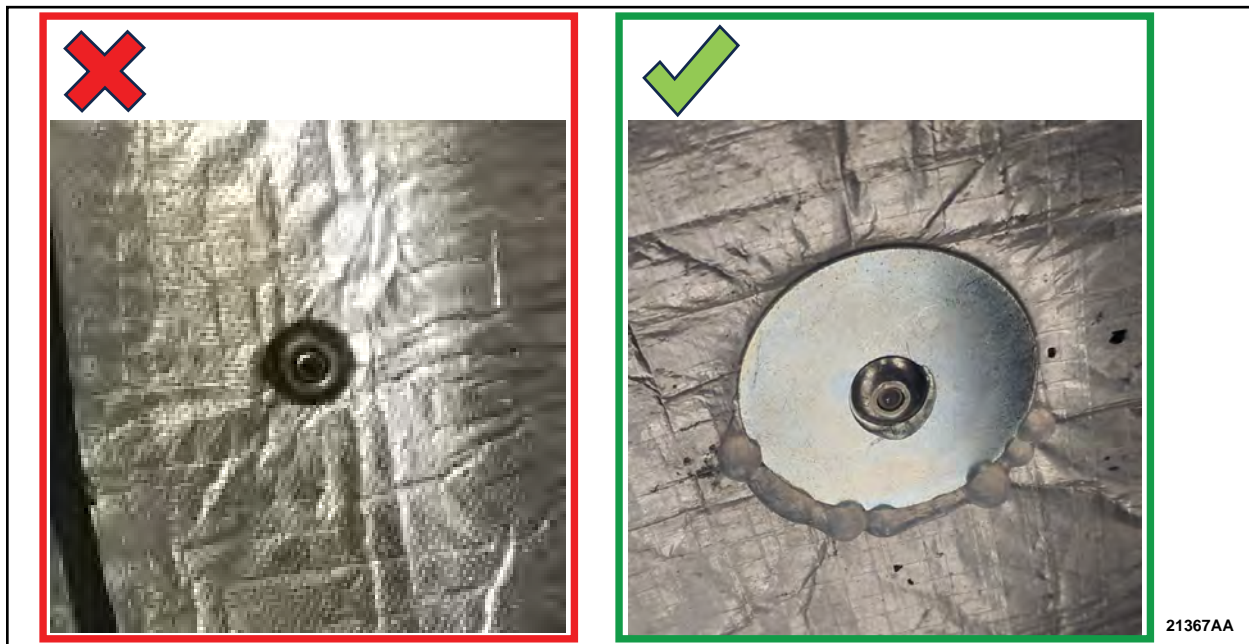

**FIGURE 15**

18. Attempt to move the washer/rivet to confirm it is properly secured.

19. Using a small brush, apply a layer of the anti-corrosion coating to the washer and rivet.

20. Repeat steps 15-19 for the remaining four drilled holes.



21. Using an air blow gun, remove any debris from threaded holes in axle flange. See Figure 16.

**NOTE:** Make sure that the mating faces are clean and free of foreign material.

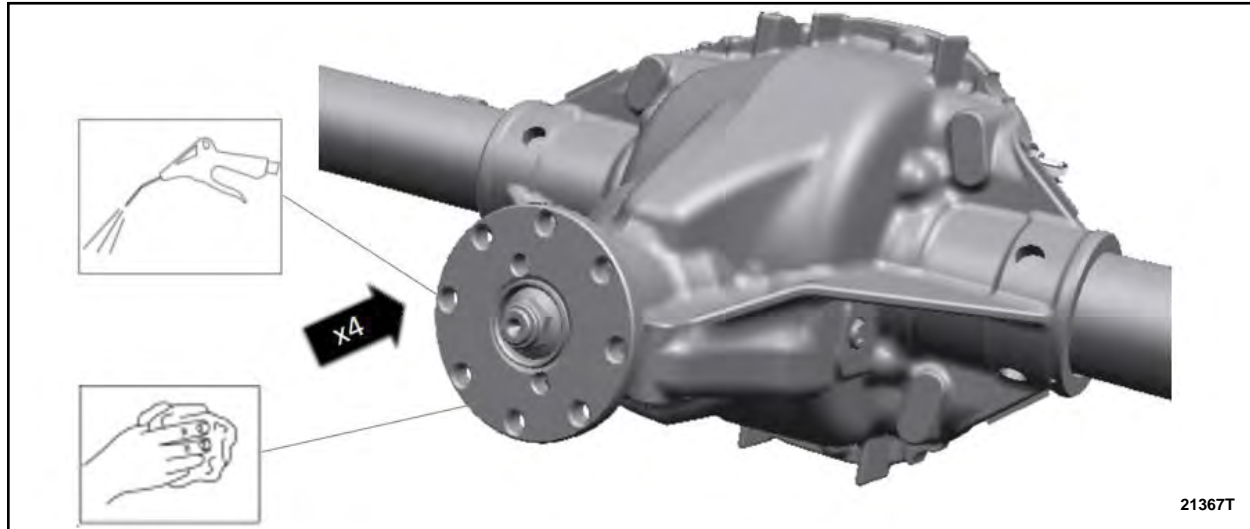

**FIGURE 16**

22. Inspect the original driveshaft flange to pinion flange bolts for rust in the threads and replace if rusted or damaged. Clean threads of the original driveshaft flange to pinion flange bolts with a wire brush and coat the threads with LOCTITE 243 Blue Medium Strength Threadlocker or equivalent. See Figure 17.

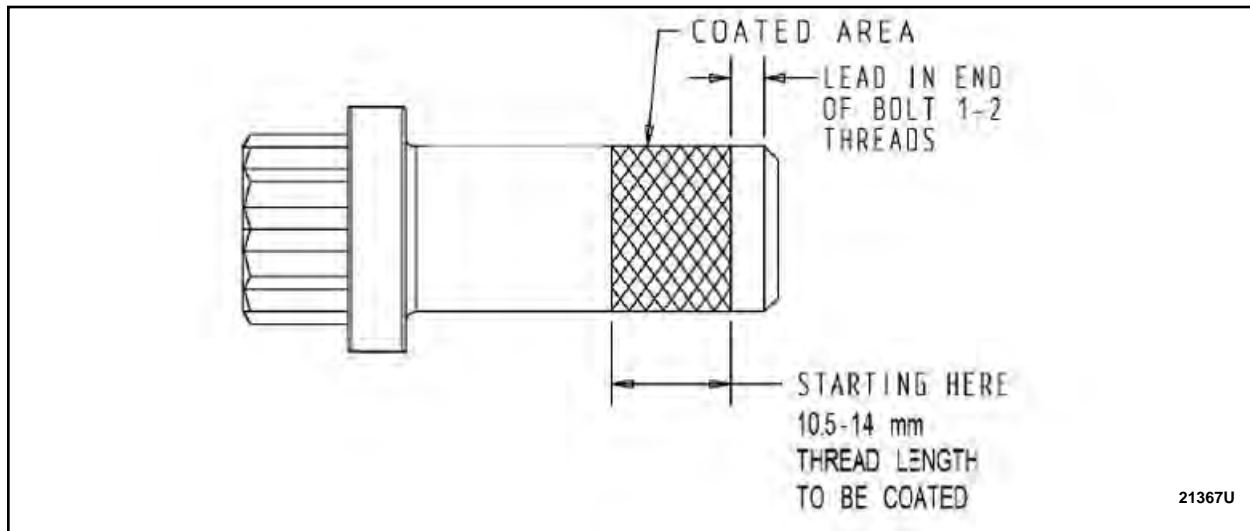

**FIGURE 17**

23. Install the driveshaft. Please follow WSM procedures in Section 205-01.



Appendix A – Acceptable Photos



FIGURE 18

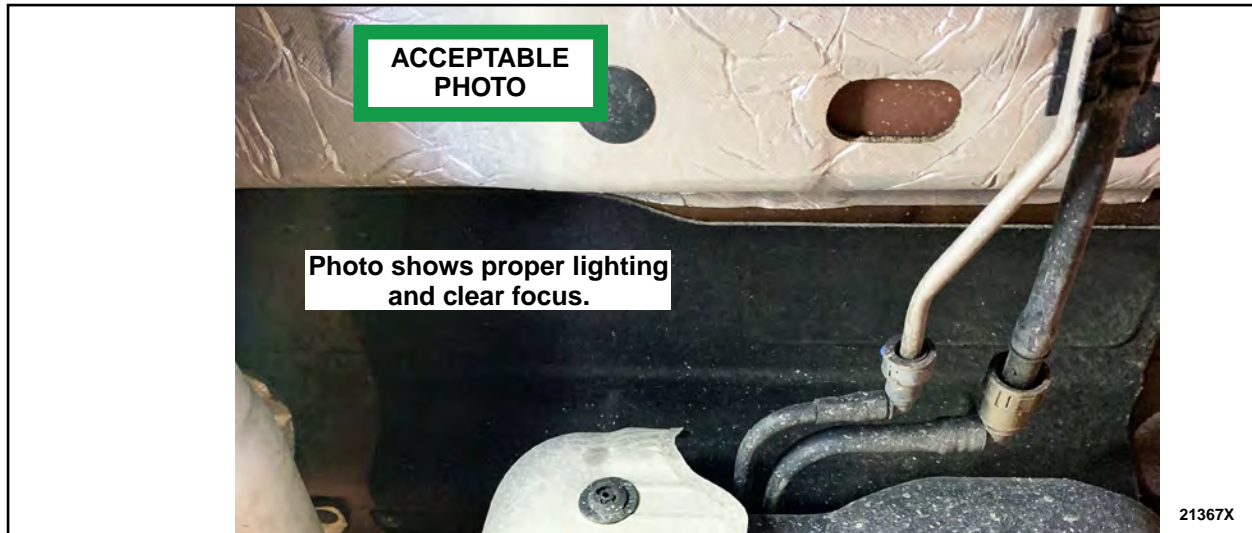

FIGURE 19



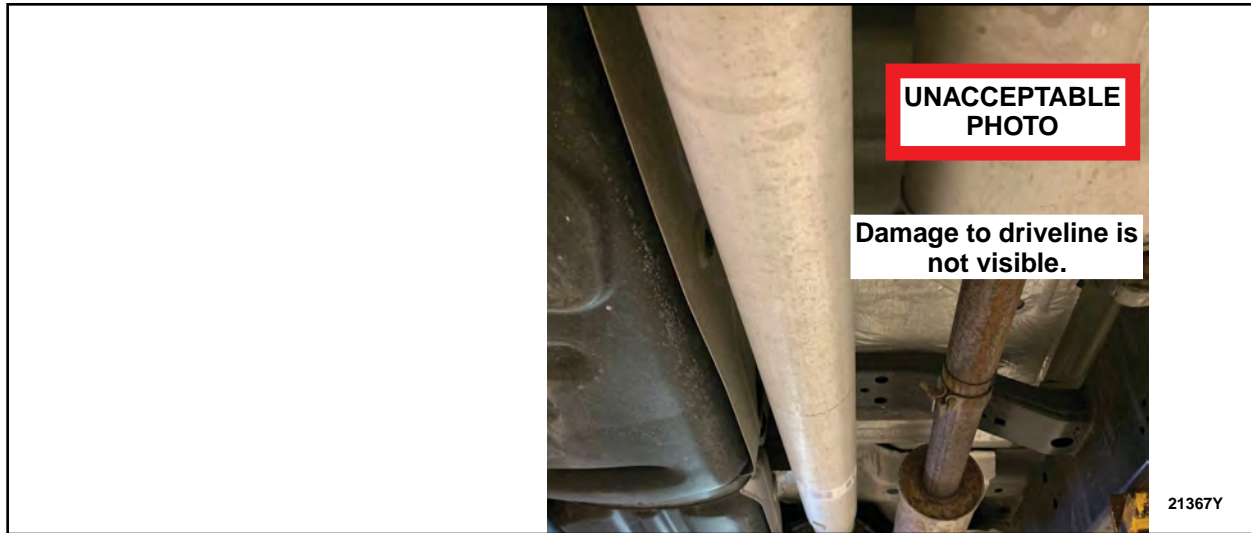

FIGURE 20



FIGURE 21





**CERTAIN 2021-2022 MODEL YEAR F-150 VEHICLES EQUIPPED WITH A CREW CAB, 145" WHEELBASE, 4X4, 302A AND ABOVE OPTION PACKAGE, AND ONE-PIECE ALUMINUM DRIVESHAFT – LOOSE/SAGGING UNDERBODY INSULATORS**

**NEW ! SERVICE PROCEDURE**

**HYBRID ENGINES**

*Table Of Contents*

*Inspection.....3*

*Driveshaft.....3*

*Zones 1, 3 and 4.....3*

*Zone 2.....5*

*ECT Sensor Connectors.....7*

*Underneath Vehicle.....8*

*Remove Passenger Side Insulator.....8*

*Clean Sheet Metal Surface.....8*

*Secure Driver Side Insulator.....9*

*Inside Vehicle.....13*

*Installing LyTherm Patch.....13*

*Appendix A - Acceptable Photos.....17*

**Materials List**

Ruler/Scale/ <b><i>Straight Edge</i></b>	13 mm (1/2 in) Drill Stop	Small Brush
Drill	6.7 mm (17/64 in) Drill Bit	Marker
1/4" Rivet Gun	5.1 mm (13/64 in) Drill Bit – Rivet W719880-S417	Tape
<b><i>Lint-Free Rags</i></b>	<b><i>Adhesive Remover</i></b>	<b><i>Plastic Scraper</i></b>

**NOTE:** A ¼" air over hydraulic rivet gun was used for the service trials for this program, however a pneumatic rivet gun or a manual rivet gun may also be used. However, it may not be possible to access and properly secure the rivets into the floor pan using a manual rivet gun. It is important to always confirm the rivet is properly secured to the floor pan of the vehicle.

**NOTE:** The driver side insulator is located directly above the fuel tank.

**NOTE:** The passenger side insulator is located directly above the exhaust.

**NOTE:** Insulators are highlighted for illustration purposes only.



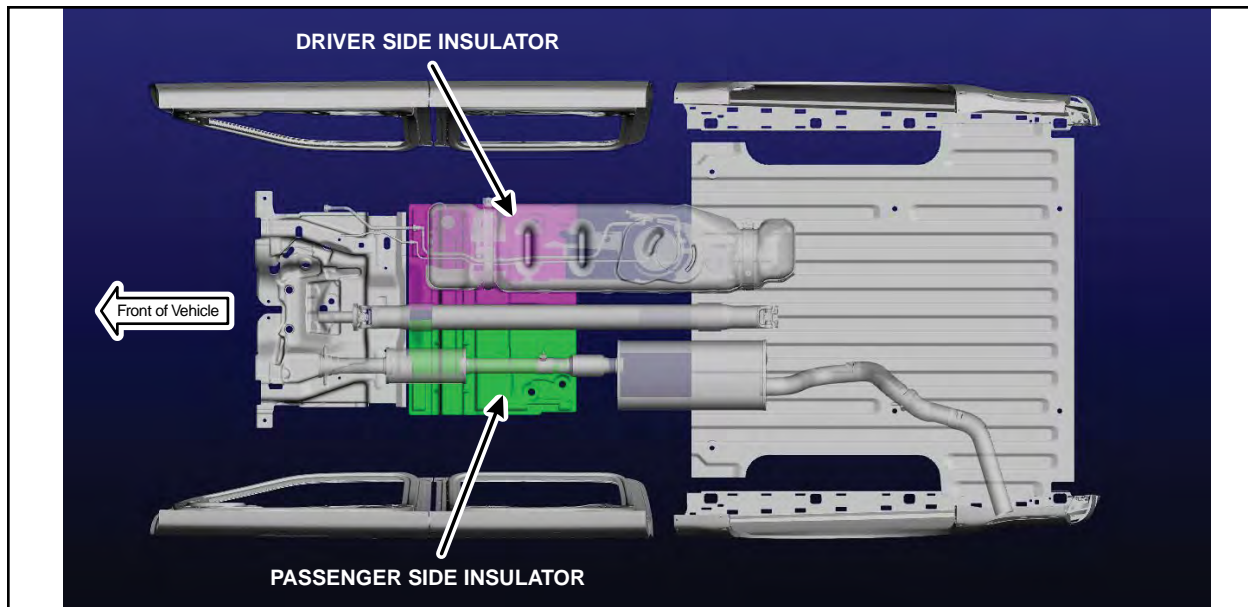

**FIGURE 1**

Dearborn Truck Plant Build Date - Design change that removed underbody insulators from production

Driver Side Insulator      11/19/2021 and later

1. Where was the vehicle manufactured?

Kansas City – See Attachment VI for correct Technical Instructions to complete repair.  
Dearborn Truck – Proceed to step 2.

2. Is the production date of the vehicle 11/19/2021 and later?

Yes – If the driver-side insulator is not present, follow technical instructions and per dealer bulletin claim 21S56B.

– If both the passenger-side and driver-side insulators are not present, no repair is necessary, close recall and claim 21S56E with 0.3 hours.

No – Proceed to step 3.

**NOTE:** Underbody Insulators should not be installed on vehicles where they were removed from production as indicated above.



## Inspection

3. With the vehicle in NEUTRAL, position it on a hoist. Please follow Workshop Manual (WSM) procedures in Section 100-02.
4. Remove the driveshaft. Please follow WSM procedures in Section 205-01.

**NOTE:** Do NOT discard the driveshaft flange to pinion flange bolts.

### Zones 1, 3 and 4

5. **Inspect Zones 1, 3 and 4 of the rear driveshaft for any marks caused by the front and/or rear edges of the passenger side insulator. Are there any marks present in Zones 1, 3 or 4? See Figure 2.**

**Yes – Proceed to step 6.**

**No – Proceed to step 8.**

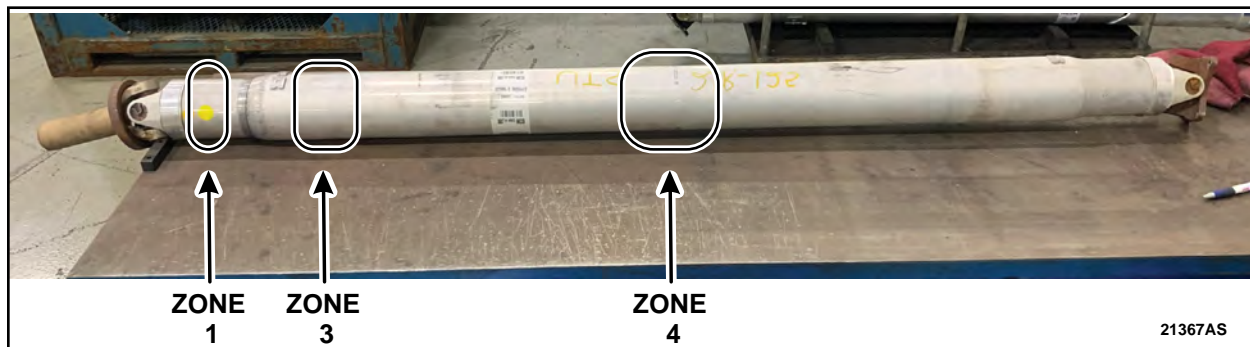

**FIGURE 2**

6. **What is the current odometer reading?**

**> 2,500 miles – Proceed to step 7.**

**< 2,500 miles – Proceed to step 8.**

7. **Place a straight edge along the driveshaft over the wear mark and attempt to fit a 0.018in (0.45mm) feeler gauge between the flat edge and the wear mark. Can the feeler gauge fit between the straight edge and anywhere along the wear mark? See Figures 3 and 4.**

**Yes – Does not pass inspection. Contact the SSSC and provide a picture of the driveshaft with the feeler gauge fitting between the straight edge and wear mark. Once approved, rear driveshaft replacement will be required, but do not install at this time. Proceed to step 10.**

**No – Passes inspection. Proceed to step 8.**





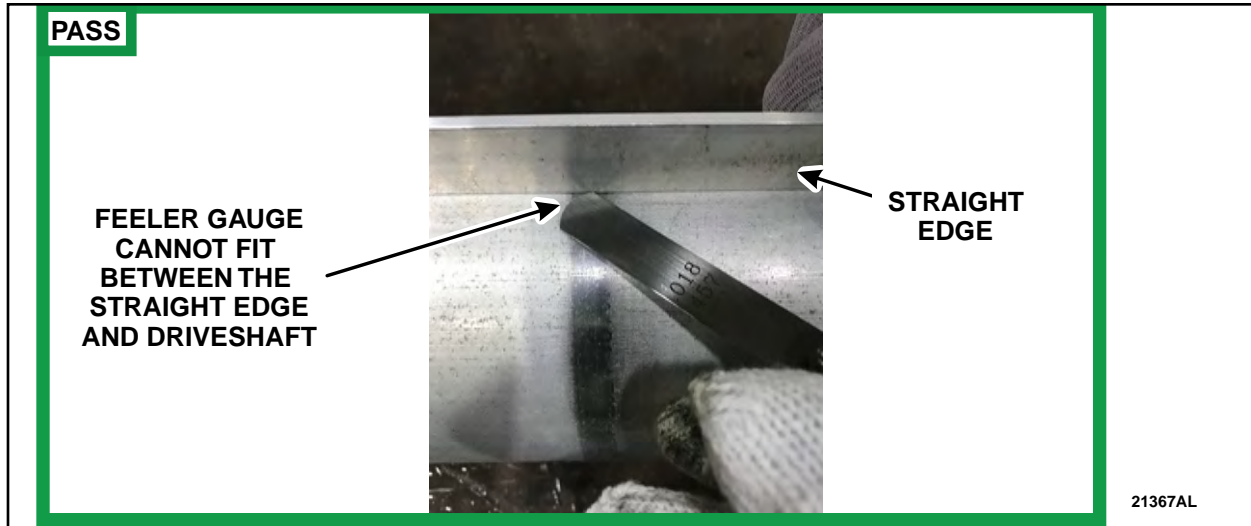

**FIGURE 3**

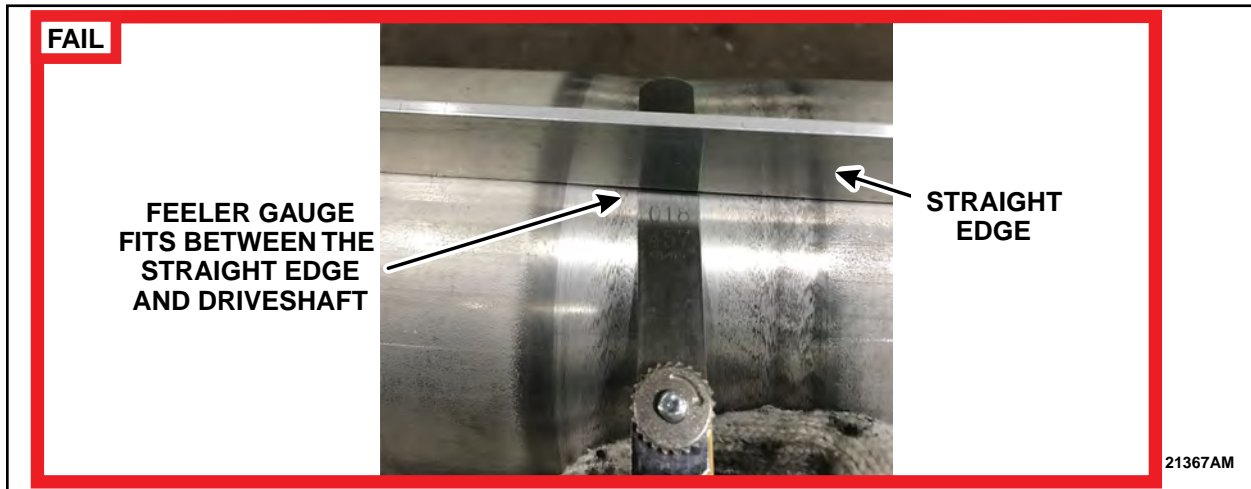

**FIGURE 4**



**Zone 2**

8. Inspect Zone 2 (transition from larger tube diameter to smaller diameter section) of the driveshaft tube for any marks caused by the front edge of the passenger side insulator. Are there any marks present? See Figure 5.

**Yes – Does not pass inspection. Proceed to step 9.**

**No – Passes inspection. Driveshaft may be reused. Proceed to step 10.**

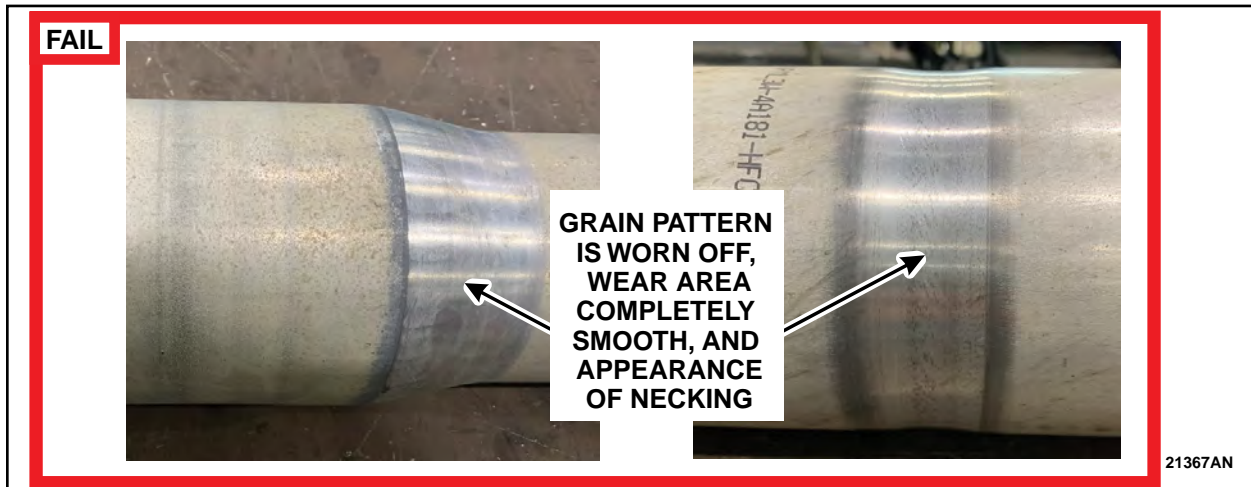

**FIGURE 5**

9. Inspect the marks found on Zone 2. Is the aluminum tube surface grain pattern worn off, completely smooth, or have an appearance of necking? See Figures 6 through 9.

**Yes – Does not pass inspection. Contact the SSSC and provide a picture of the driveshaft with the grain pattern worn off. Be sure to show a clear image of the grain pattern missing. Once approved, rear driveshaft replacement will be required, but do not install at this time. Proceed to step 10.**

**No – Passes inspection. Driveshaft may be reused. Proceed to step 10.**



**FIGURE 6**



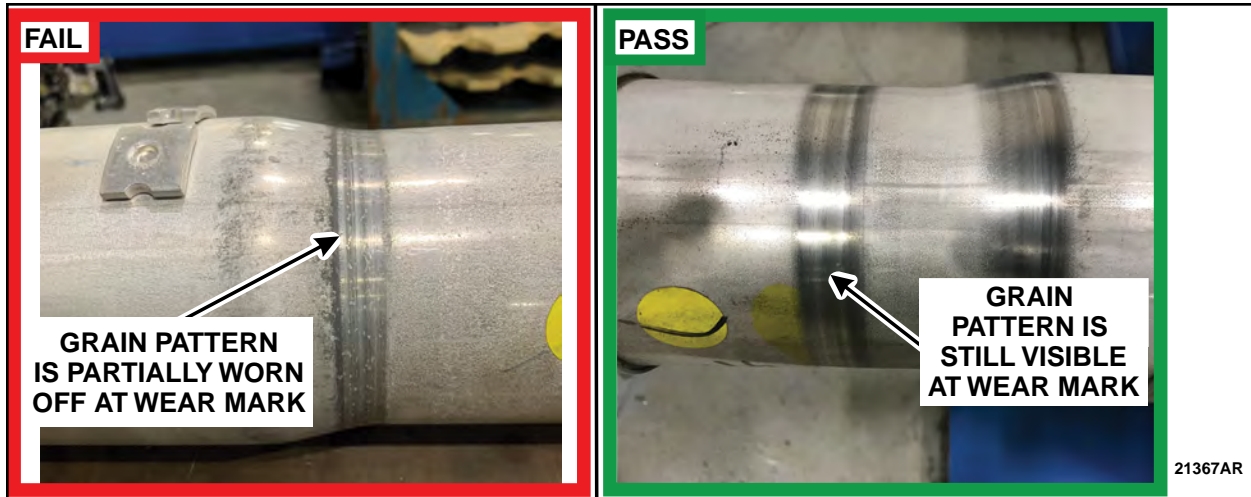

FIGURE 7

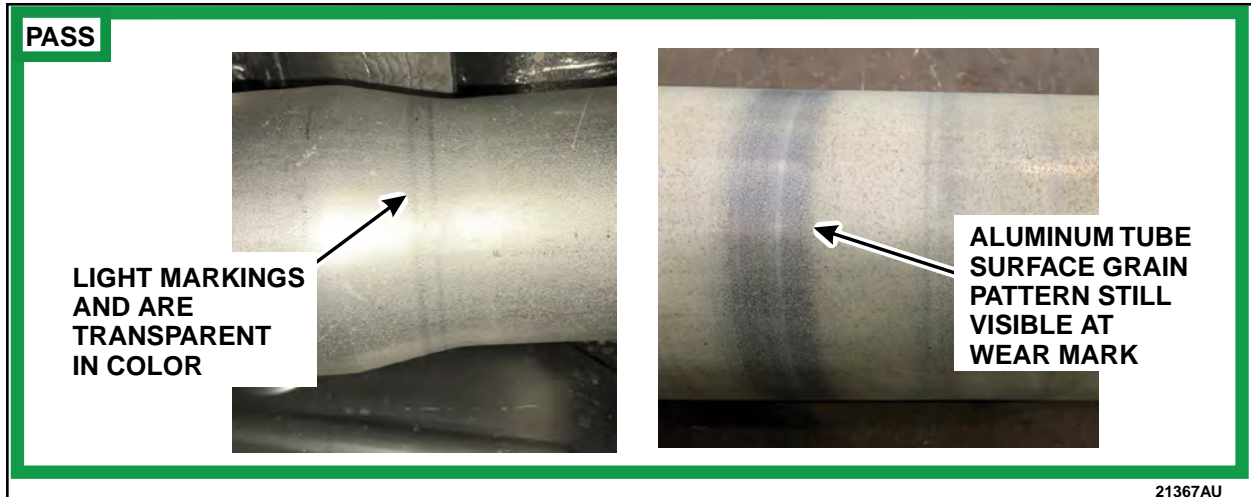

FIGURE 8



FIGURE 9



10. Inspect the front Engine Coolant Temperature (ECT) sensor connectors for any damage caused by the passenger side insulator. Is there any damage? See Figure 10.

Yes – Does not pass inspection. Contact the SSSC and provide a picture of the damage for proper technical instructions and part numbers, then proceed to step 11.

No – Proceed to step 11.

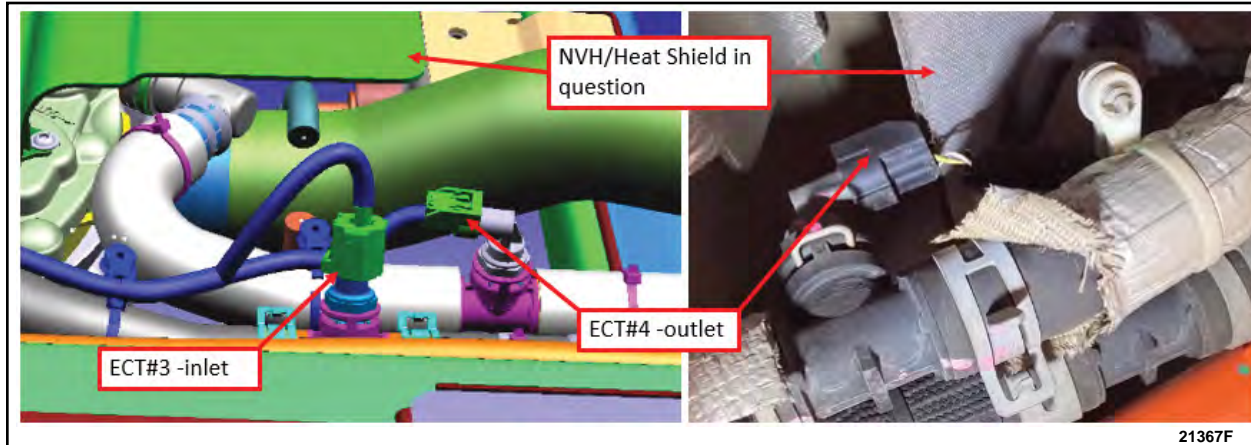

FIGURE 10





**Underneath Vehicle**

**Remove Passenger Side Insulator**

11. Carefully remove and discard the passenger side insulator from the underside of the pickup bed. See Figure 11.

**NOTE:** Do NOT use metal scrapers, wire brushes, power sanding or grinding discs, or any abrasive means to clean surfaces. These tools cause scratches and gouges which make leak paths.



**FIGURE 11**

**Clean Sheet Metal Surface**

12. Using both hands and/or a plastic scraper, remove as much of the remaining substrate material as possible. See Figure 12.

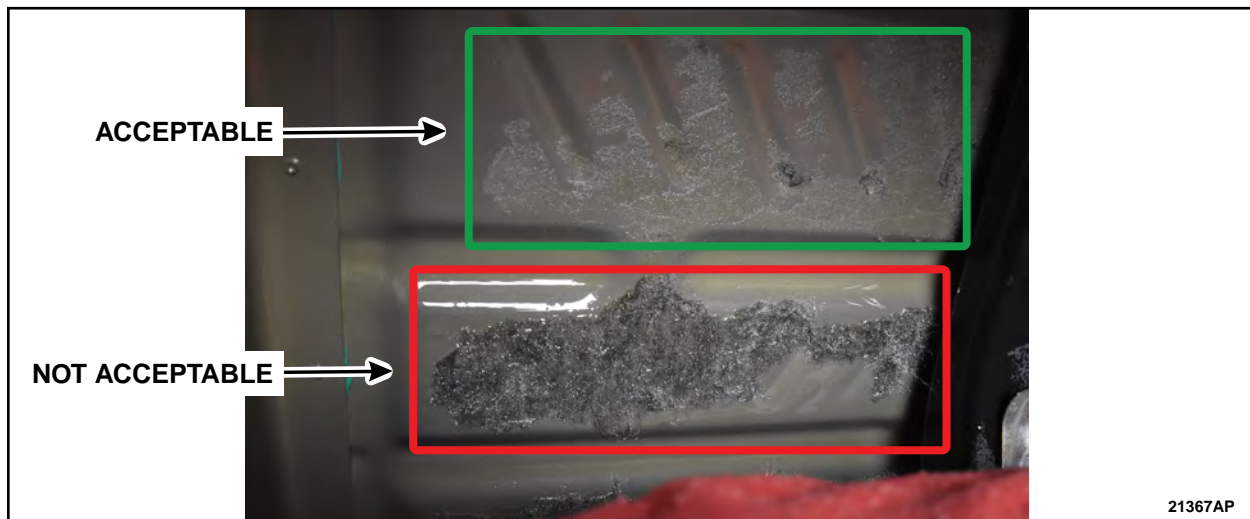

**FIGURE 12**

13. Using Mineral Spirits/Goo-Gone/3M Adhesive Remover/Brake Cleaner and lint-free rags or equivalent, clean the sheet metal surface.





### Secure *Driver Side* Insulator

14. Measure and mark the one location on the driver side insulator. See Figures 13 and 14.

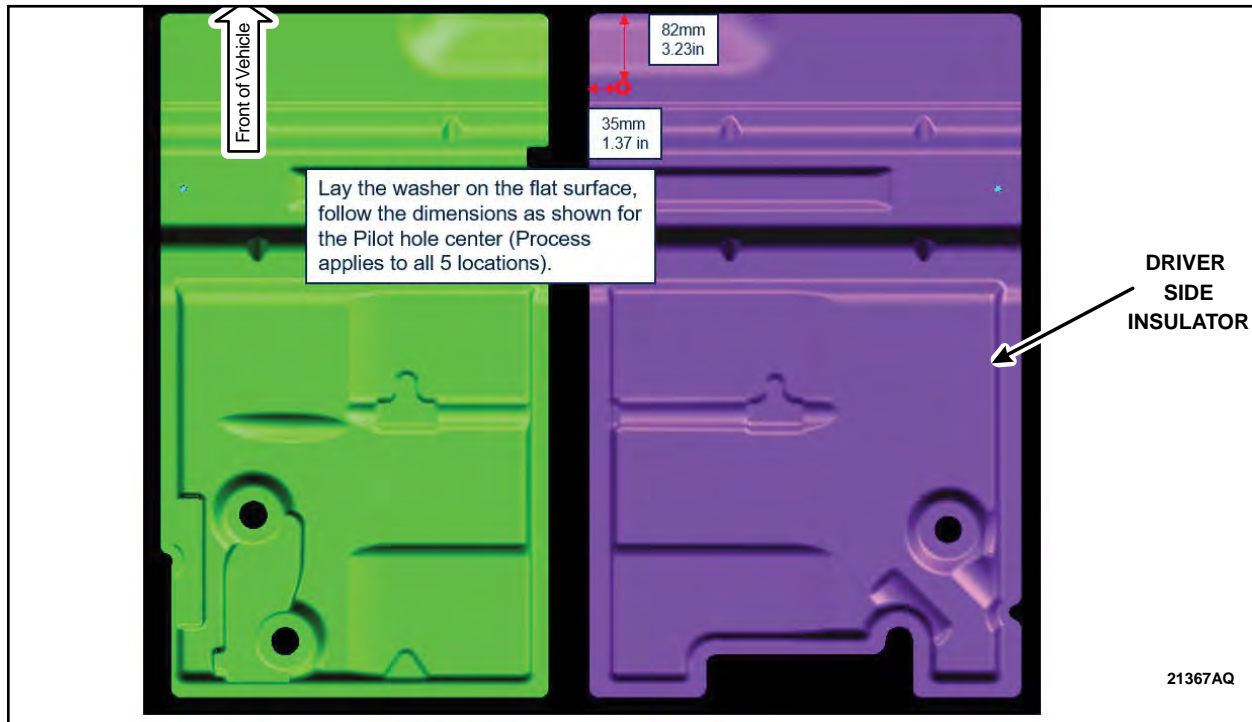

**FIGURE 13**

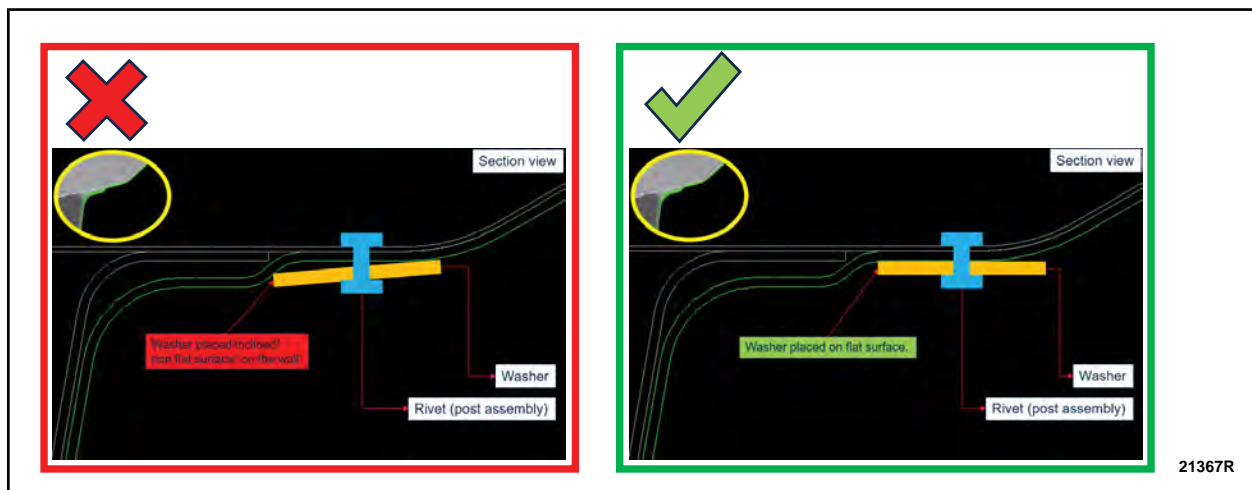
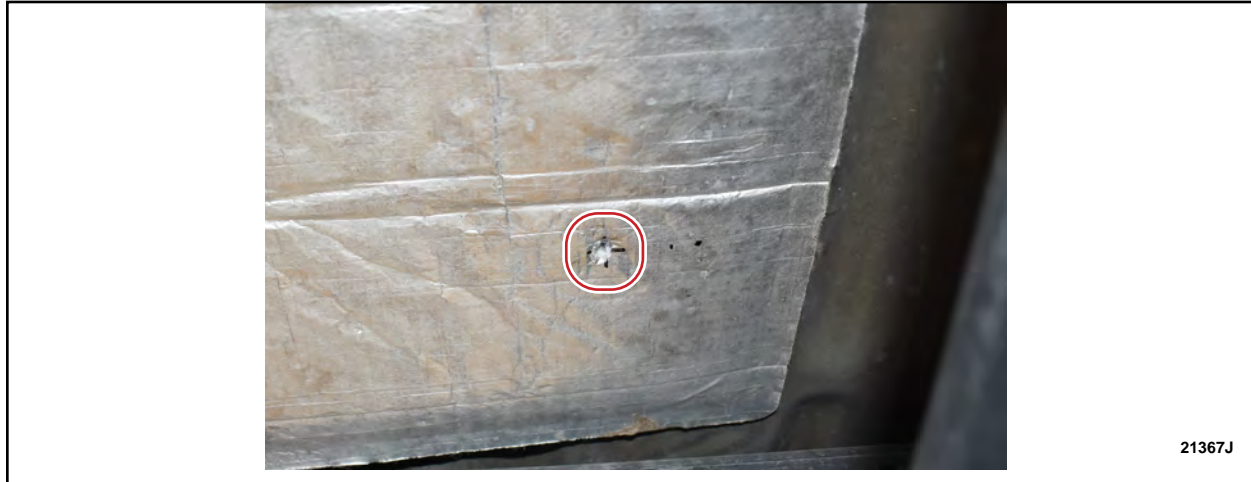

**FIGURE 14**



15. Use the 5.1 mm (13/64 in) drill bit for rivet part number W719880-S417 or the 6.7mm (17/64 in) drill bit for all other rivet part numbers to drill a hole through the insulator and into the floor. See Figure 15.

**NOTE:** Use the 13mm (1/2 in) drill stop to ensure you do not drill through the carpet.



**FIGURE 15**

16. Using a small brush, apply a layer of the anti-corrosion coating to the edges of the newly drilled hole.
17. Install the washer onto the rivet. See Figure 16.

**NOTE:** All approved listed rivet part numbers may not look identical to the photos in the technical instructions.



**FIGURE 16**



18. Apply a thick layer of seam sealer to the rivet, and the backside of the washer. See Figure 17.



**FIGURE 17**

19. Using a 1/4" rivet gun, install the rivet and washer to the drilled hole. See Figure 18.

**NOTE:** To ensure the rivet is properly secured, apply as much force to the rivet gun as possible.

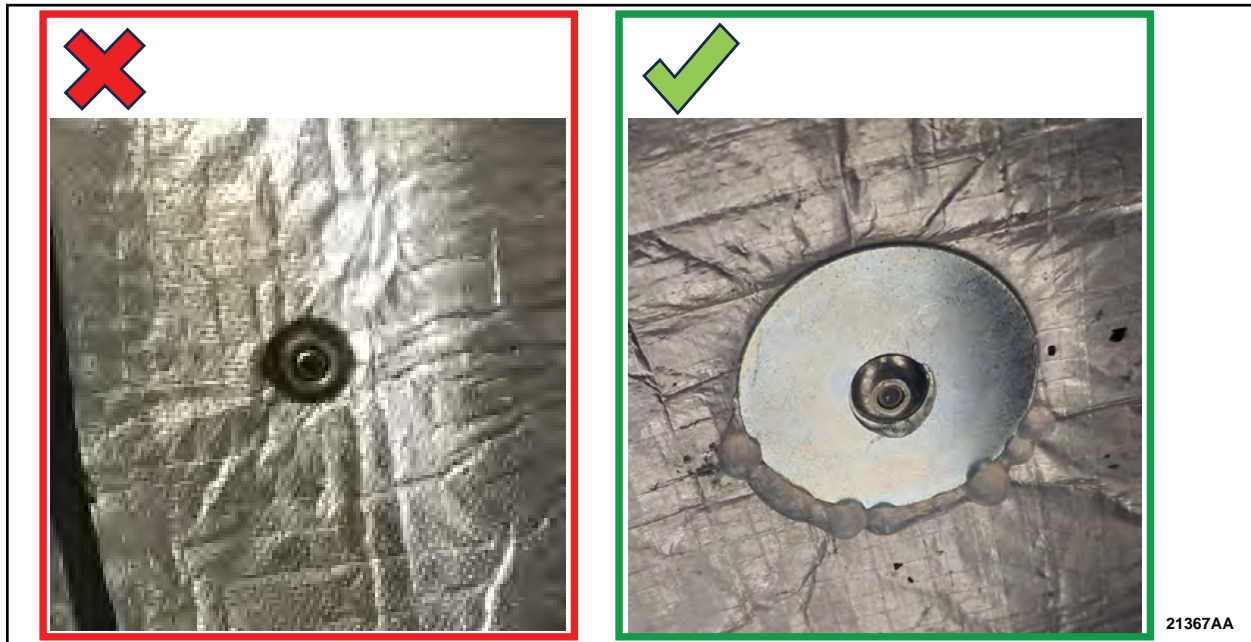

**FIGURE 18**

20. Attempt to move the washer/rivet to confirm it is properly secured.

21. Using a small brush, apply a layer of the anti-corrosion coating to the washer and rivet.



22. Using an air blow gun, remove any debris from threaded holes in axle flange. See Figure 19.

**NOTE:** Make sure that the mating faces are clean and free of foreign material.

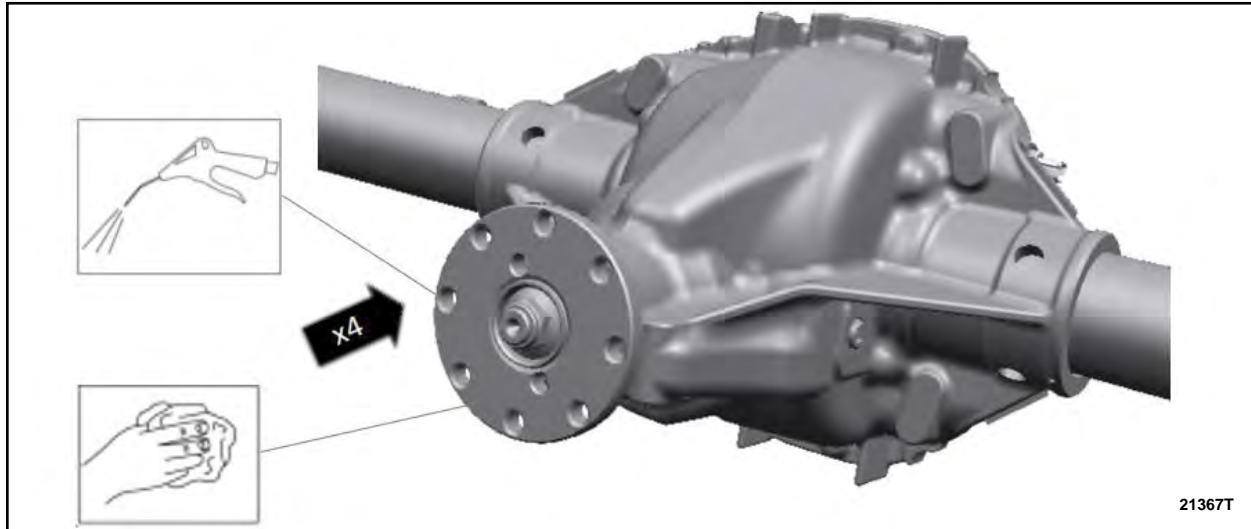

**FIGURE 19**

23. Inspect the original driveshaft flange to pinion flange bolts for rust in the threads and replace if rusted or damaged. Clean threads of the original driveshaft flange to pinion flange bolts with a wire brush and coat the threads with LOCTITE 243 Blue Medium Strength Threadlocker or equivalent. See Figure 20.

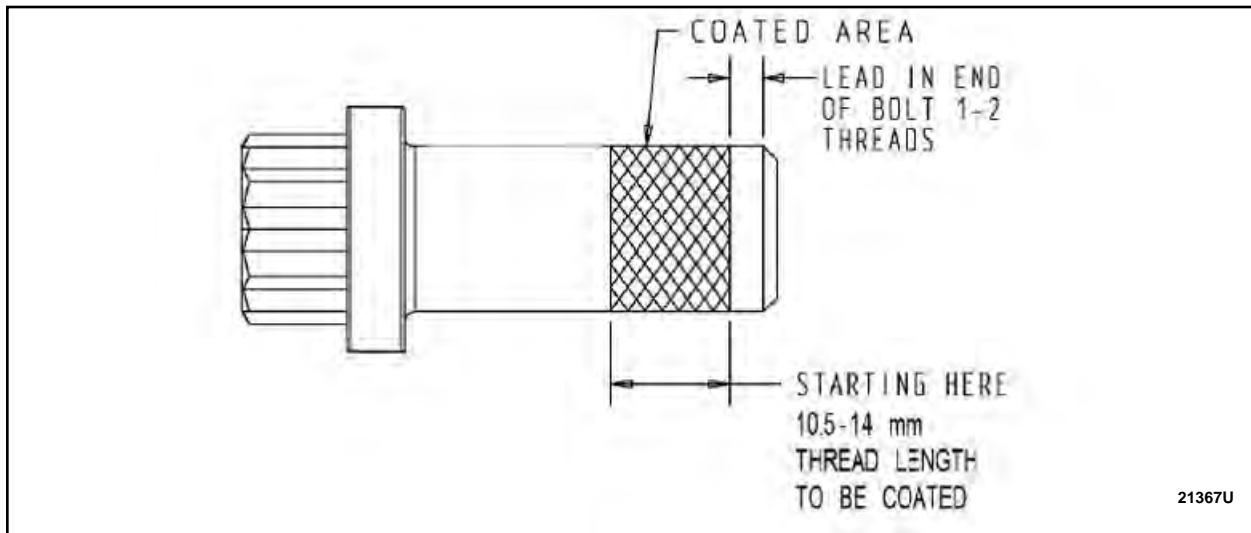

**FIGURE 20**

24. Install the driveshaft. Please follow WSM procedures in Section 205-01.



**Inside Vehicle**

**Installing LyTherm Patch**

25. Position the front RH seat in the full forward position.
26. Remove the RH front scuff plate trim panel. Please follow WSM procedures in Section 501-05.
27. Remove the RH rear scuff plate trim panel. Please follow WSM procedures in Section 501-05.
28. Release the tabs and remove the RH front seatbelt retractor and pretensioner opening trim cover. See Figure 21.

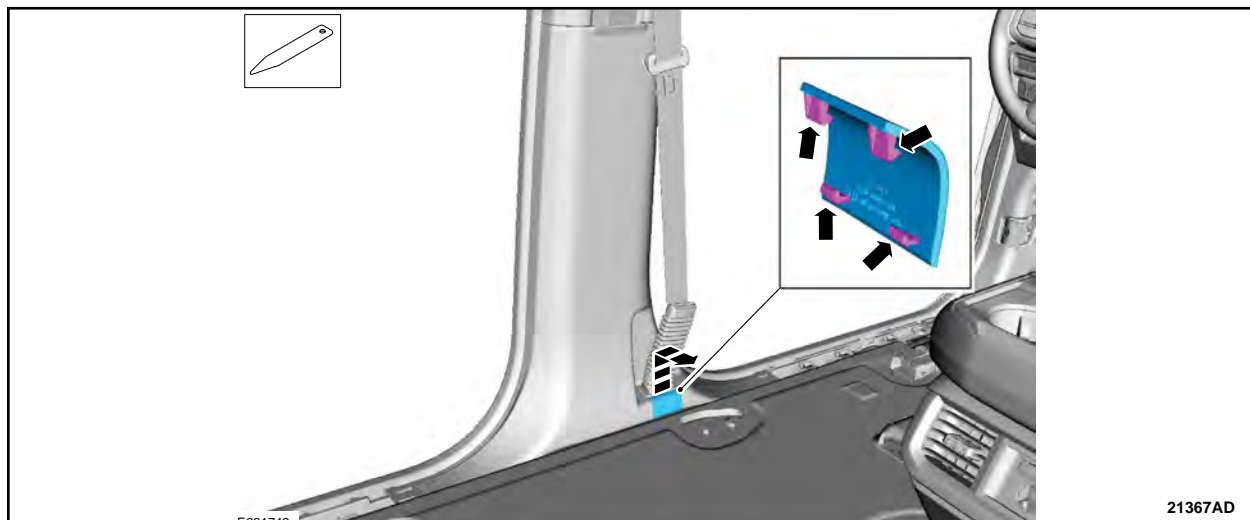

**FIGURE 21**

29. Release the RH front seatbelt retractor and pretensioner boot from the lower B-pillar trim panel and position upward on the seatbelt. See Figure 22.

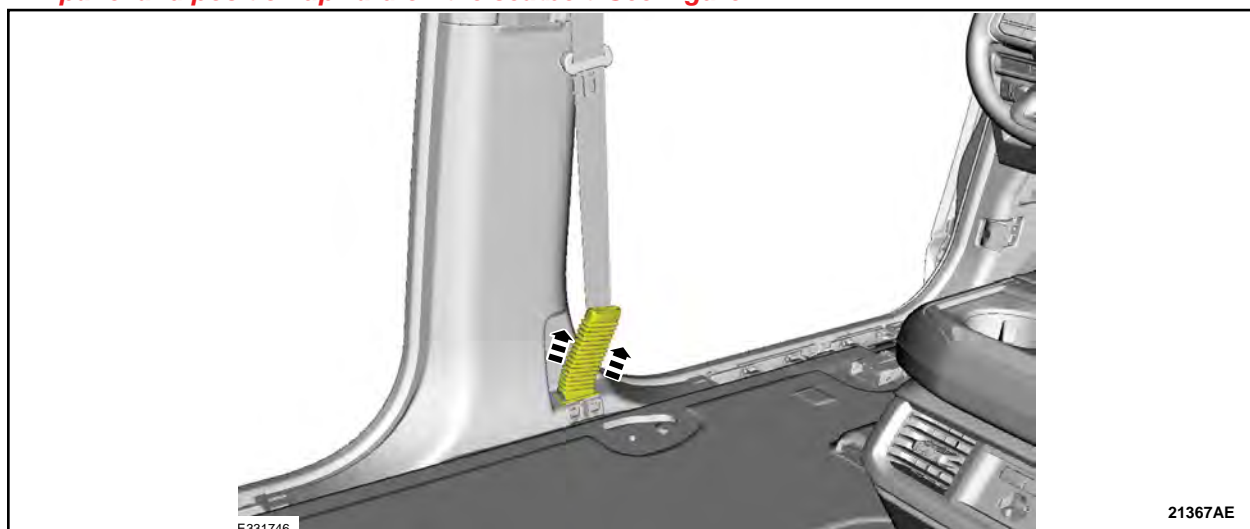

**FIGURE 22**





**30. Release the RH lower B-pillar trim panel clips and position the lower B-pillar trim panel aside.  
See Figure 23.**

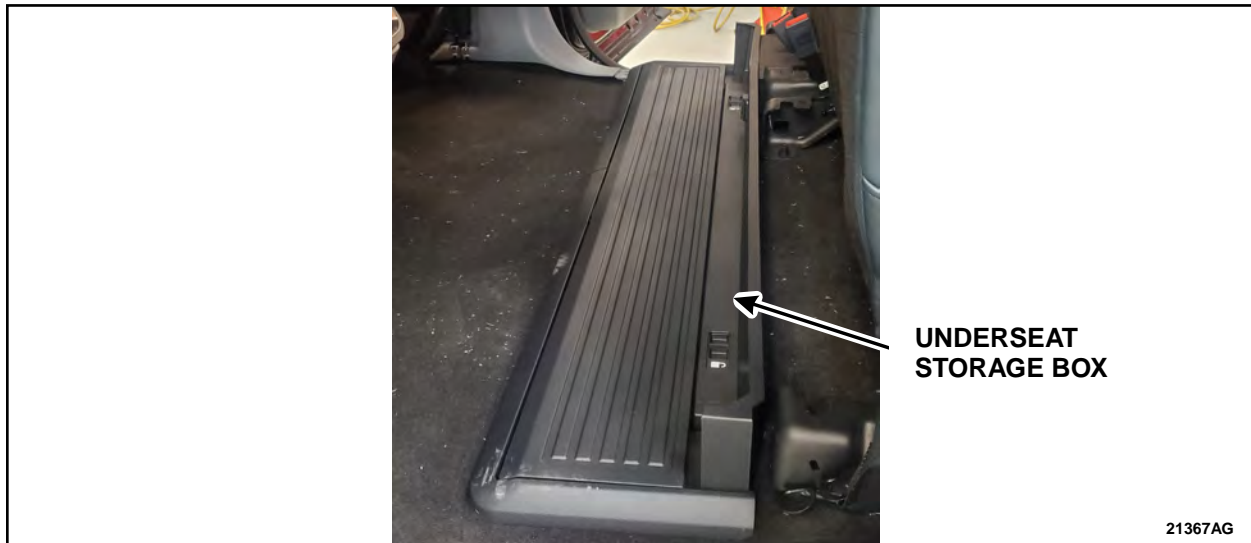

**FIGURE 23**

**31. Is the vehicle equipped with a rear underseat storage box? See Figure 24.**

**Yes – For additional allowed labor time to remove, contact the SSSC and provide a picture of the rear underseat storage box. Once approved, proceed to step 32.**

**No – Proceed to step 33.**



**FIGURE 24**



**32. Remove the rear underseat storage box.**

- a. Remove all four nut covers.**
- b. Remove all four nuts.**
- c. Remove the rear underseat storage box.**

**33. Lift up the carpet and slide the LyTherm patch between the floor and the carpet into the proper location. See Figures 25 and 26.**

**NOTE: Make sure there are no bumps or folds in the patch after installing.**

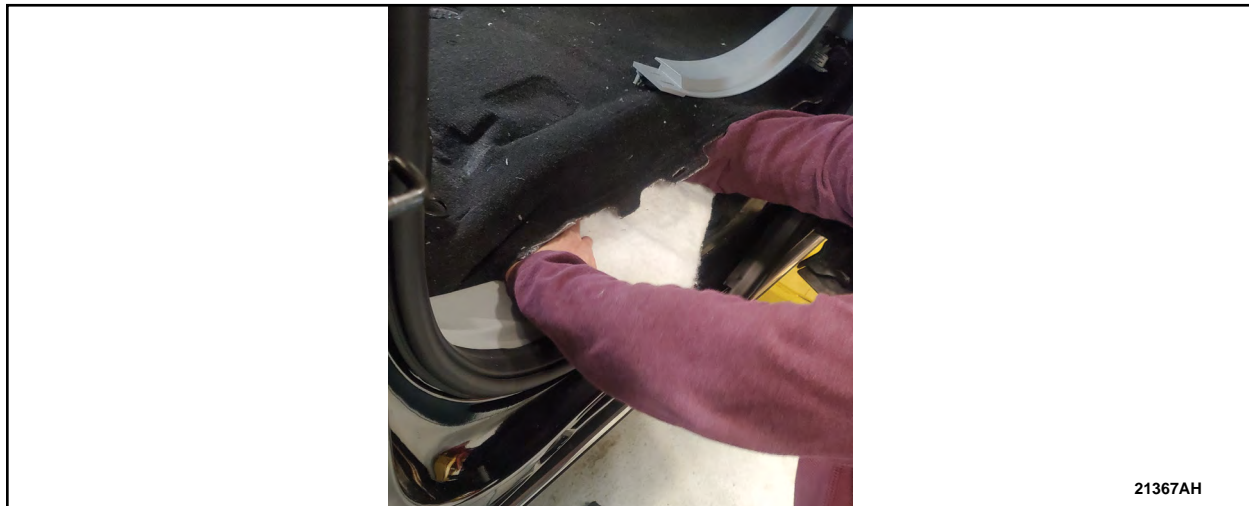

**FIGURE 25**

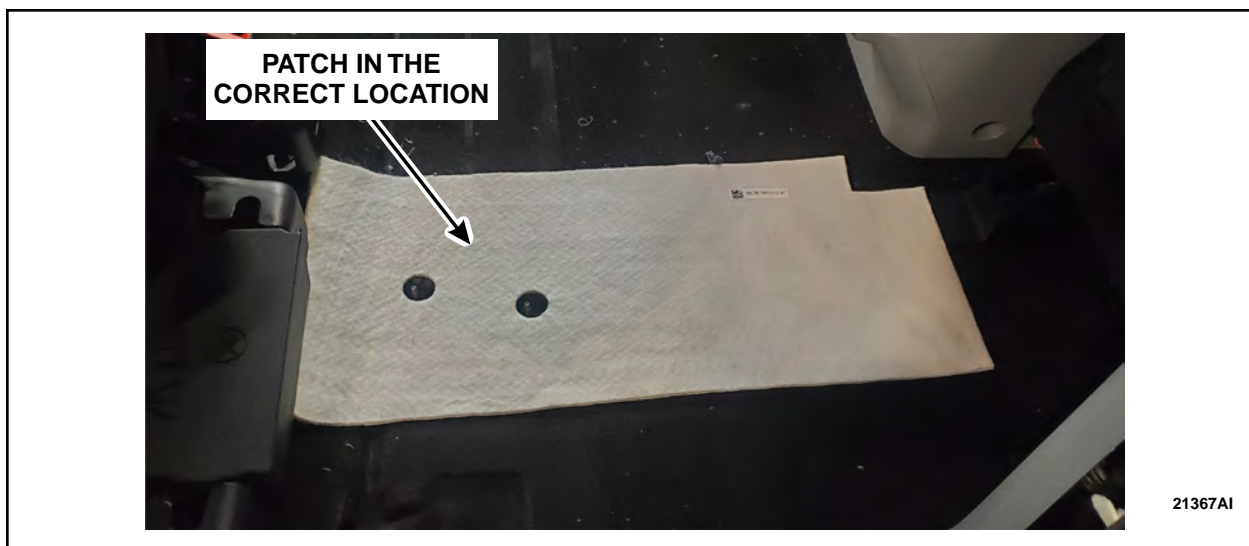

**FIGURE 26**



**34. Cut two 8 inch long pieces of tape and install them to the edge of the patch. See Figure 27.**

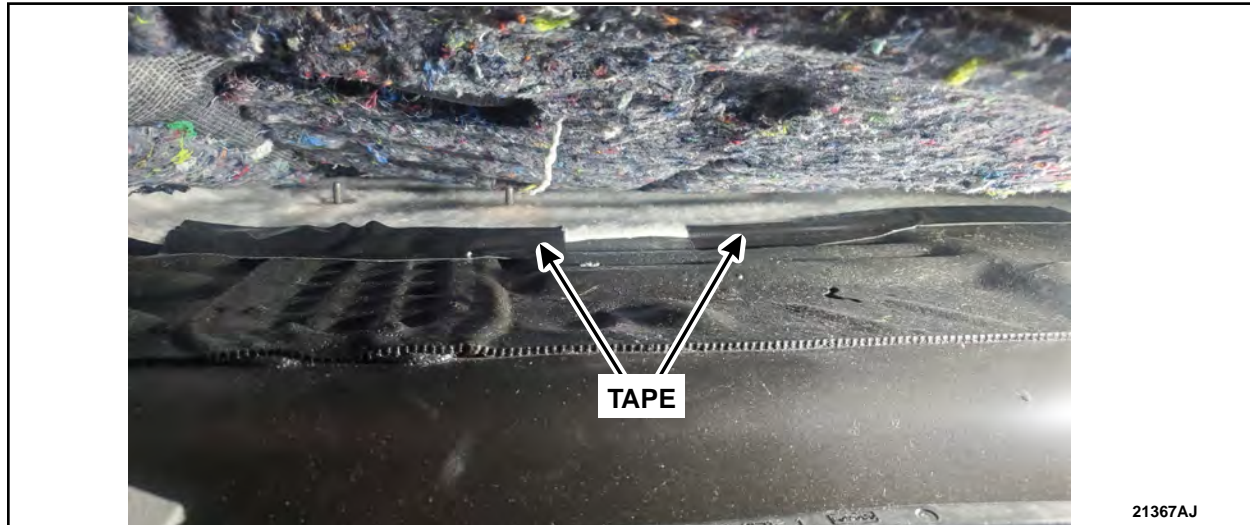

**FIGURE 27**

**35. Install the rear underseat storage box if it was removed.**

- a. Install the rear underseat storage box.**
- b. Install all four nuts.**
  - Torque: 14.75 lb. ft (20Nm)
- c. Install all four nut covers.**

**36. Re-install all previously removed components by reversing steps 25 through 30.**



Appendix A – Acceptable Photos



FIGURE 28

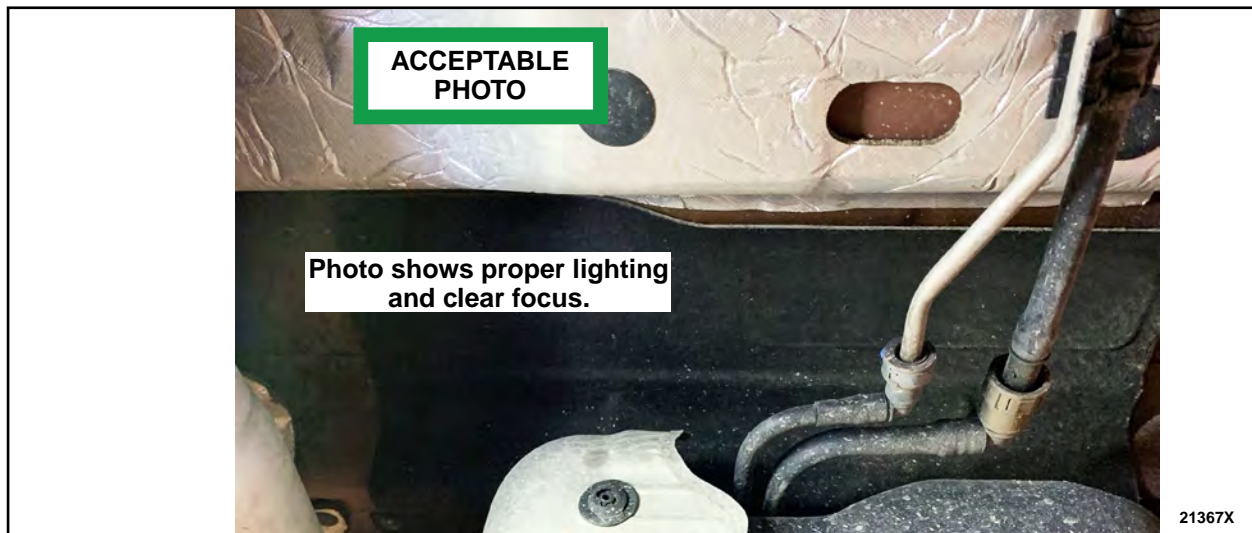

FIGURE 29



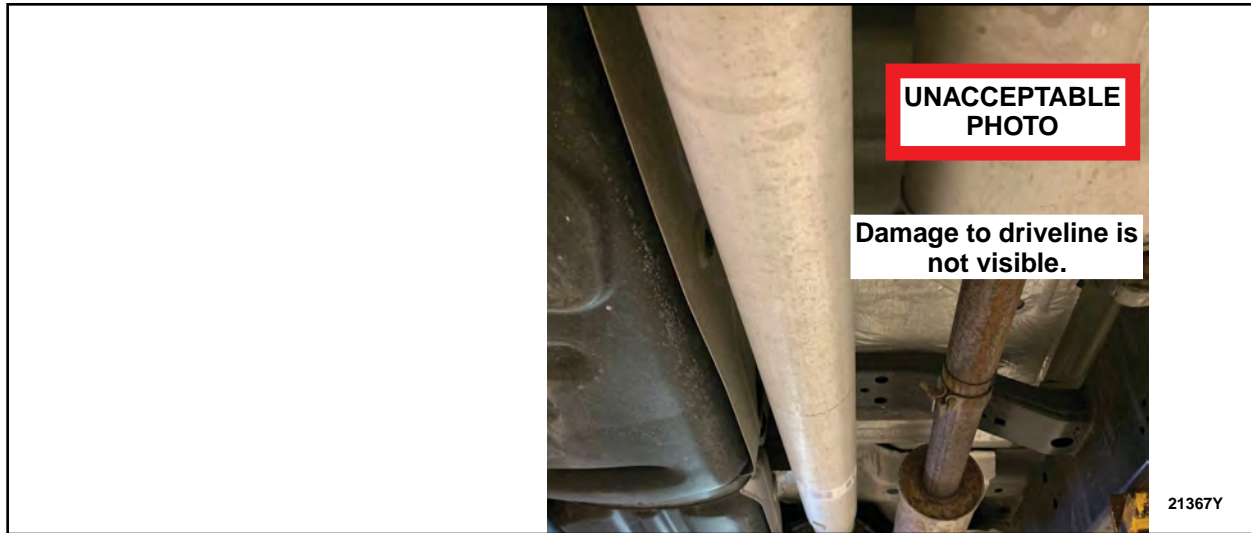

FIGURE 30



FIGURE 31





**CERTAIN 2021-2022 MODEL YEAR F-150 VEHICLES EQUIPPED WITH A CREW CAB, 145" WHEELBASE, 4X4, 302A AND ABOVE OPTION PACKAGE, AND ONE-PIECE ALUMINUM DRIVESHAFT – LOOSE/SAGGING UNDERBODY INSULATORS**

**NEW ! SERVICE PROCEDURE**

**GAS ENGINES – VEHICLES MANUFACTURED AT KANSAS CITY TRUCK ASSEMBLY PLANT**

*Table Of Contents*

*Check for DTCs.....3*

*Inspection.....3*

*Driveshaft.....3*

*Zones 1, 3 and 4.....3*

*Zone 2.....5*

*Securing Underbody Insulators.....7*

*Appendix A - Acceptable Photos.....11*

**Review the video link below before starting this repair procedure:**

 <https://bcove.video/3rdmqR0>

**Materials List**

Ruler/Scale/ <b><i>Straight Edge</i></b>	13 mm (1/2 in) Drill Stop	Small Brush
Drill	6.7 mm (17/64 in) Drill Bit	Marker
1/4" Rivet Gun	5.1 mm (13/64 in) Drill Bit – Rivet W719880-S417	Tape

**NOTE:** A ¼" air over hydraulic rivet gun was used for the service trials for this program, however a pneumatic rivet gun or a manual rivet gun may also be used. However, it may not be possible to access and properly secure the rivets into the floor pan using a manual rivet gun. It is important to always confirm the rivet is properly secured to the floor pan of the vehicle.

**NOTE:** The driver side insulator is located directly above the fuel tank.

**NOTE:** The passenger side insulator is located directly above the exhaust.

**NOTE:** Insulators are highlighted for illustration purposes only.



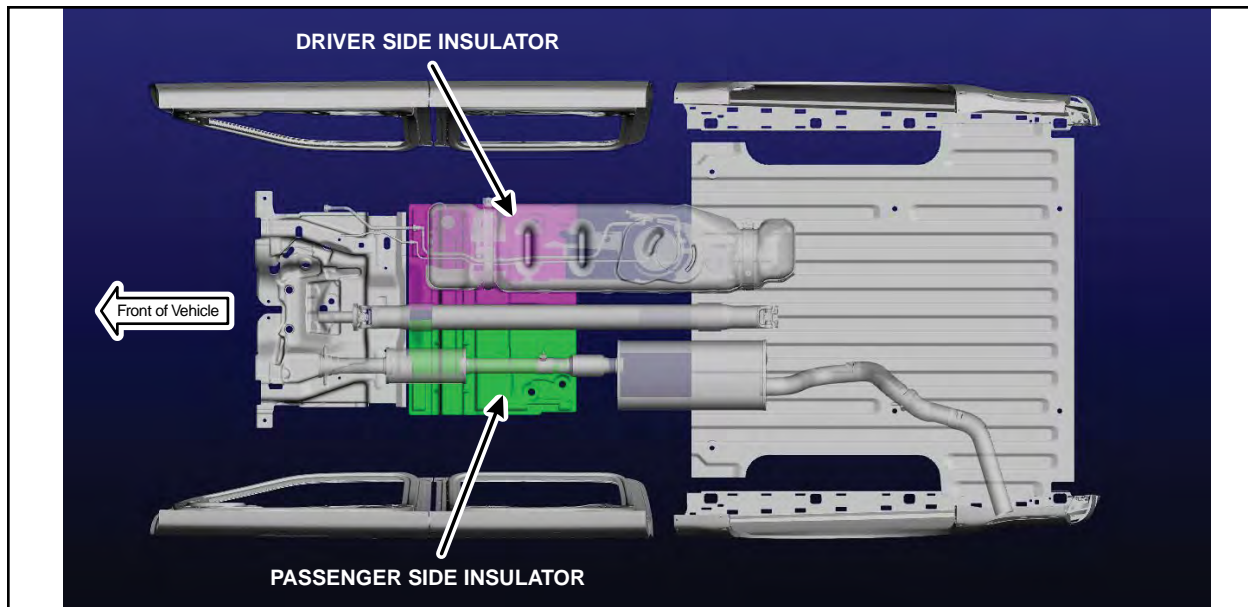

**FIGURE 1**

Kansas City Build Date - Design change that removed underbody insulators from production

Passenger Side Insulator	10/18/2021 and later
Driver Side Insulator	11/19/2021 and later

1. Where was the vehicle manufactured?

Dearborn Truck – See either Attachment III, IV, or V for correct Technical Instructions to complete repair.

Kansas City– Proceed to step 2.

2. Is the production date of the vehicle 10/18/2021 and later?

Yes – If the passenger-side insulator is not present, follow technical instructions and per dealer bulletin claim 21S56B.

No – Proceed to step 3.

3. Is the production date of the vehicle 11/19/2021 and later?

Yes – If the driver-side insulator is not present, follow technical instructions and per dealer bulletin claim 21S56B.

– If both the passenger-side and driver-side insulators are not present, no repair is necessary, close recall and claim 21S56E with 0.3 hours.

No – Proceed to step 4.

**NOTE:** Underbody Insulators should not be installed on vehicles where they were removed from production as indicated above.



### Check for DTCs

- Using the Ford Diagnostic and Repair System (FDRS), check the Powertrain Control Module (PCM) for DTCs. Are either of the following DTC's present in the PCM, P0442 and/or P0456?

Yes - Please follow Workshop Manual (WSM) procedures for pinpoint test HX in Section 303-13, then proceed to step 5.  
No - Proceed to step 5.

### Inspection

- With the vehicle in NEUTRAL, position it on a hoist. Please follow Workshop Manual (WSM) procedures in Section 100-02.
- Remove the driveshaft. Please follow WSM procedures in Section 205-01.

**NOTE:** Do NOT discard the driveshaft flange to pinion flange bolts.

### Zones 1, 3 and 4

- Inspect **Zones 1, 3 and 4** of the rear driveshaft for any marks caused by the front and/or rear edges of the passenger side insulator. Are there any marks present in Zones 1, 3 or 4? See Figure 2.

Yes – Proceed to step 8.  
No – Proceed to step 10.

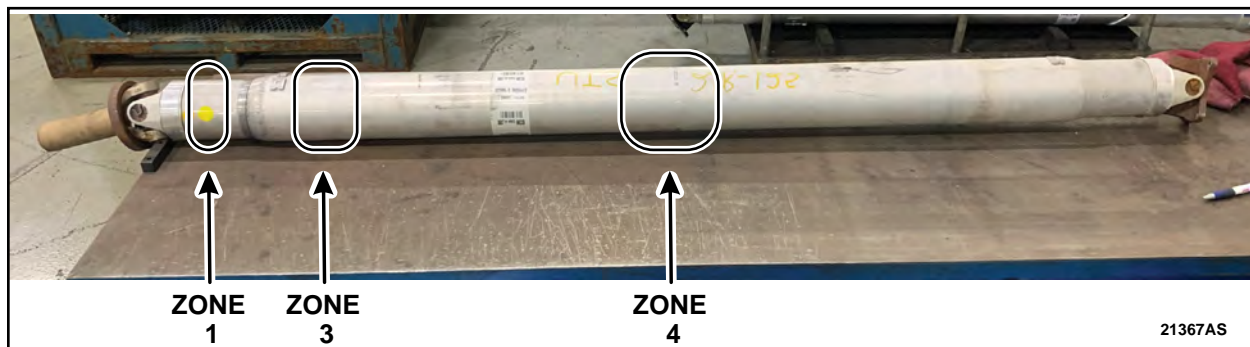

**FIGURE 2**

- What is the current odometer reading?

> 2,500 miles – Proceed to step 9.  
< 2,500 miles – Proceed to step 10.



9. Place a straight edge along the driveshaft over the wear mark and attempt to fit a 0.018in (0.45mm) feeler gauge between the flat edge and the wear mark. Can the feeler gauge fit between the straight edge and anywhere along the wear mark? See Figures 3 and 4.

**Yes** – Does not pass inspection. Contact the SSSC and provide a picture of the driveshaft with the feeler gauge fitting between the straight edge and wear mark. Once approved, rear driveshaft replacement will be required, but do not install at this time. Proceed to step 12.

**No** – Passes inspection. Proceed to step 10.

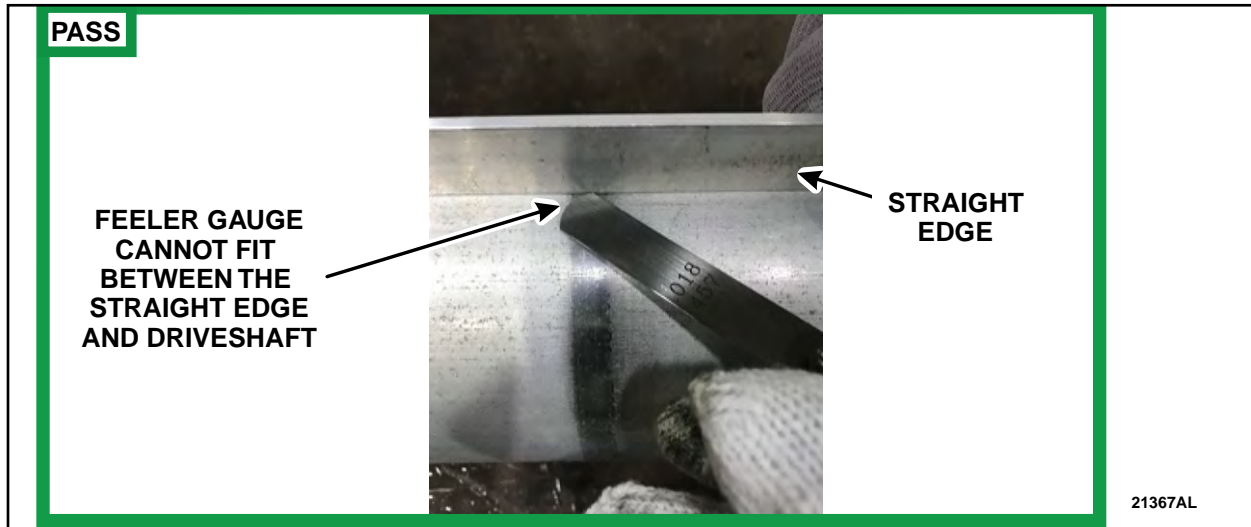

**FIGURE 3**

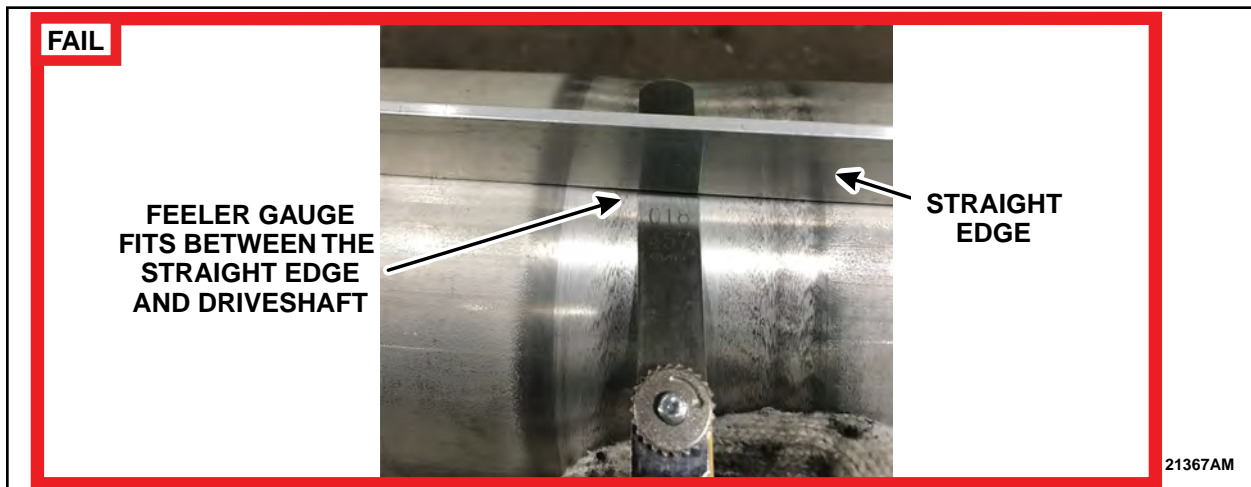

**FIGURE 4**



**Zone 2**

**10. Inspect Zone 2 (transition from larger tube diameter to smaller diameter section) of the driveshaft tube for any marks caused by the front edge of the passenger side insulator. Are there any marks present? See Figure 5.**

**Yes – Does not pass inspection. Proceed to step 11.**

**No – Passes inspection. Driveshaft may be reused. Proceed to step 12.**

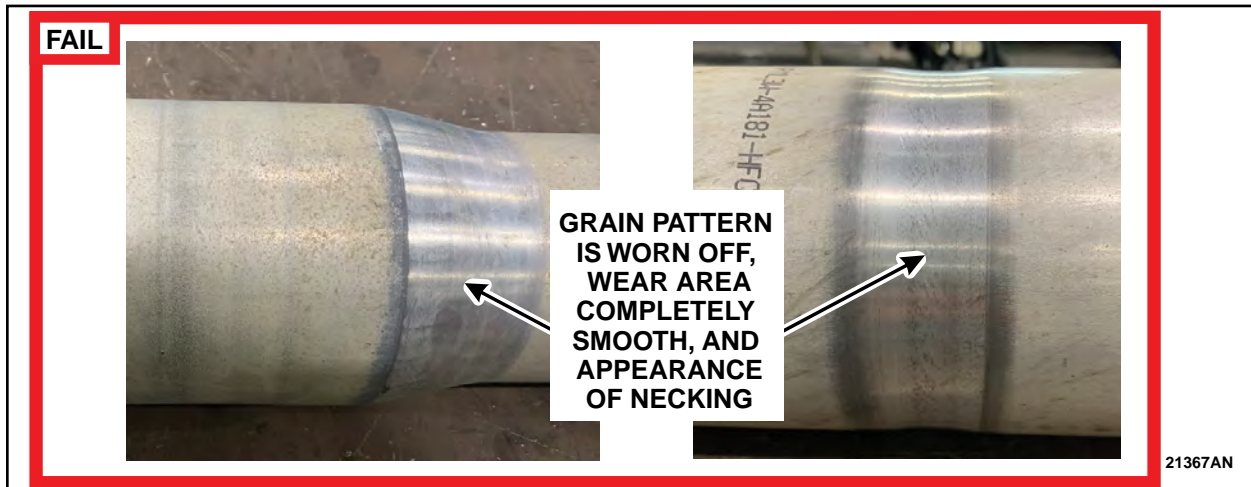

**FIGURE 5**

**11. Inspect the marks found on Zone 2. Is the aluminum tube surface grain pattern worn off, completely smooth, or have an appearance of necking? See Figures 6 through 9.**

**Yes – Does not pass inspection. Contact the SSSC and provide a picture of the driveshaft with the grain pattern worn off. Be sure to show a clear image of the grain pattern missing. Once approved, rear driveshaft replacement will be required, but do not install at this time. Proceed to step 12.**

**No – Passes inspection. Driveshaft may be reused. Proceed to step 12.**



**FIGURE 6**





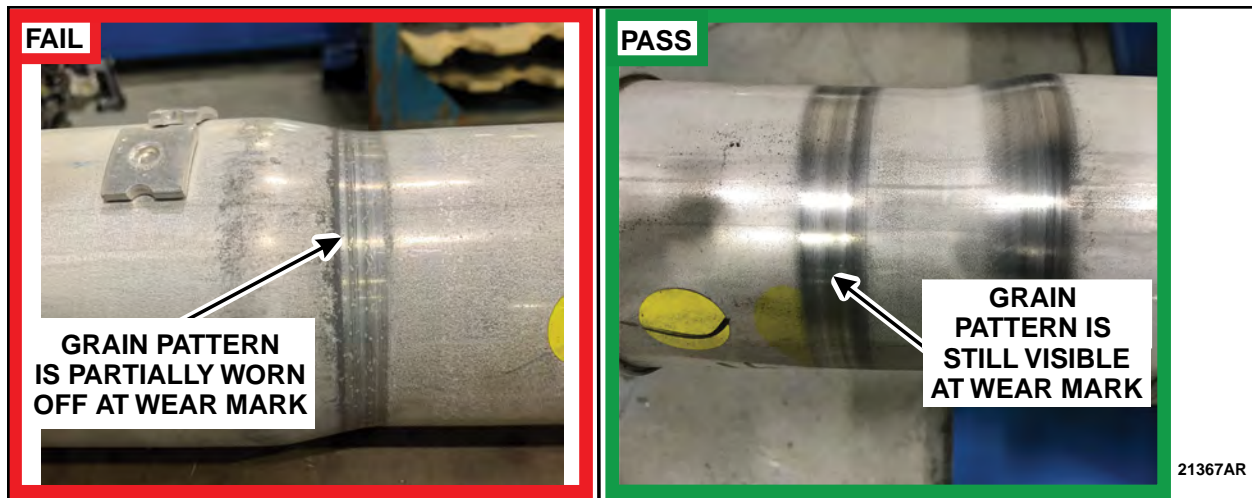

**FIGURE 7**

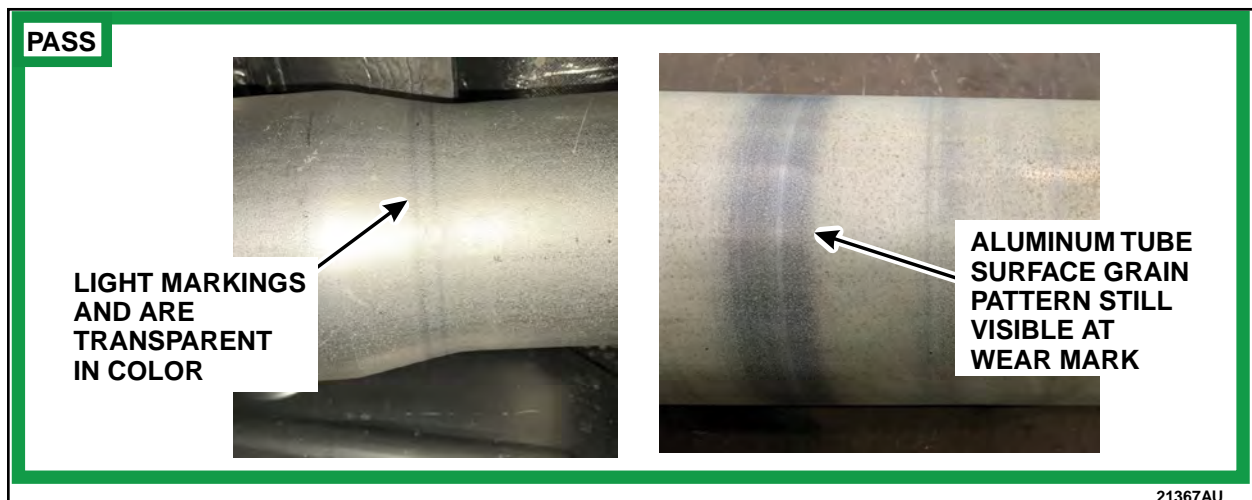

**FIGURE 8**

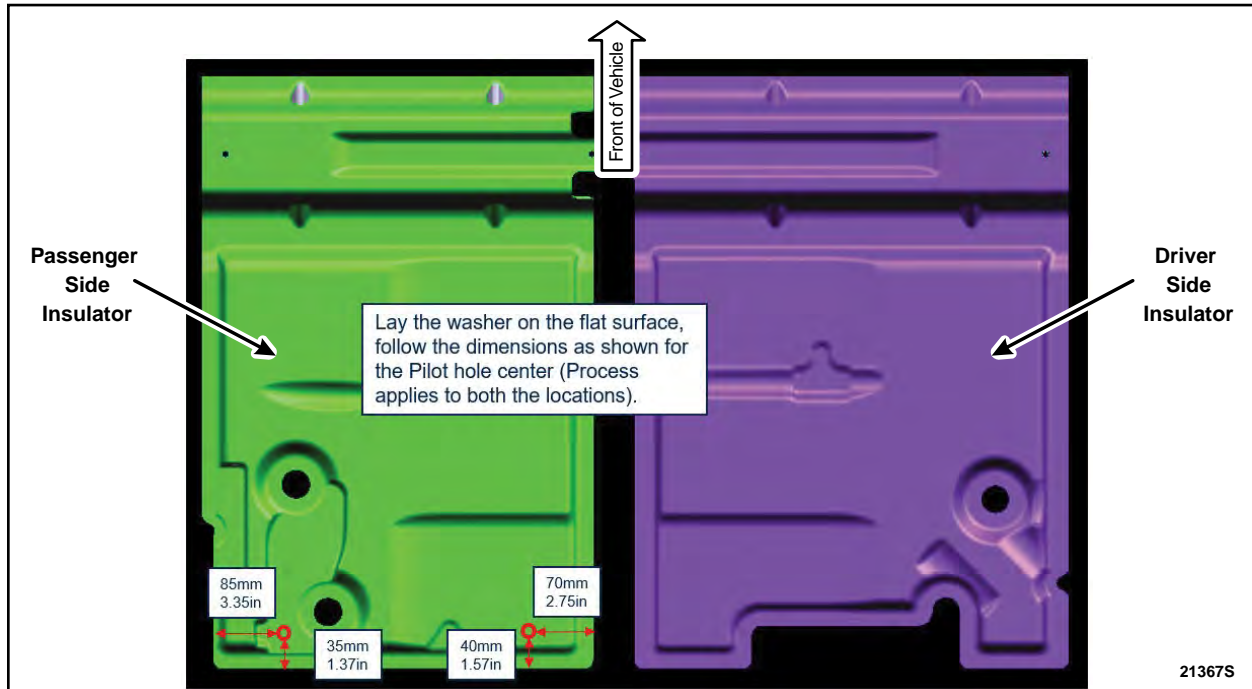

**FIGURE 9**



### Securing Underbody Insulators

12. Measure and mark the two locations on the passenger side insulator. See Figure 10.



**FIGURE 10**

13. Use the 5.1 mm (13/64 in) drill bit for rivet part number W719880-S417 or the 6.7mm (17/64 in) drill bit for all other rivet part numbers to drill a hole through the insulator and into the floor. See Figure 11.

**NOTE:** Use the 13mm (1/2 in) drill stop to ensure you do not drill through the carpet.

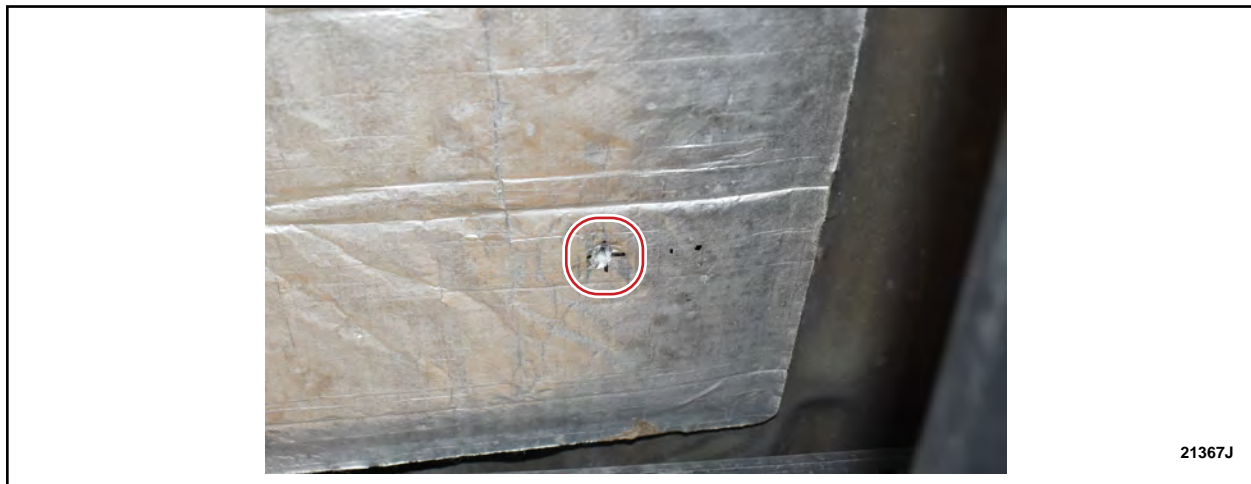

**FIGURE 11**



14. Repeat step 13 for the second marked location.
15. Using a small brush, apply a layer of the anti-corrosion coating to the edges of the newly drilled holes.
16. Install the washer onto the rivet. See Figure 12.

**NOTE:** All approved listed rivet part numbers may not look identical to the photos in the technical instructions.



**FIGURE 12**

17. Apply a thick layer of seam sealer to the rivet, and the backside of the washer. See Figure 13.

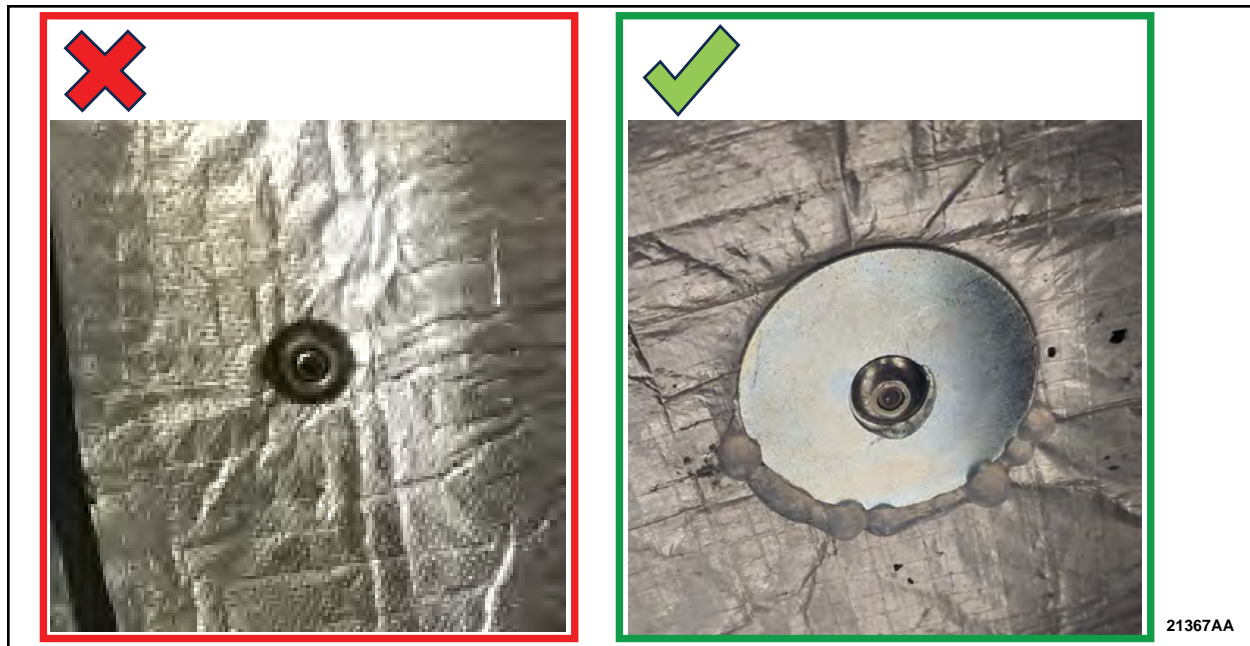

**FIGURE 13**



18. Using a 1/4" rivet gun, install the rivet and washer to the drilled hole. See Figure 14.

**NOTE:** To ensure the rivet is properly secured, apply as much force to the rivet gun as possible.



**FIGURE 14**

19. Attempt to move the washer/rivet to confirm it is properly secured.

20. Using a small brush, apply a layer of the anti-corrosion coating to the washer and rivet.

21. Repeat steps 16-20 for the second drilled hole.





22. Using an air blow gun, remove any debris from threaded holes in axle flange. See Figure 15.

**NOTE:** Make sure that the mating faces are clean and free of foreign material.

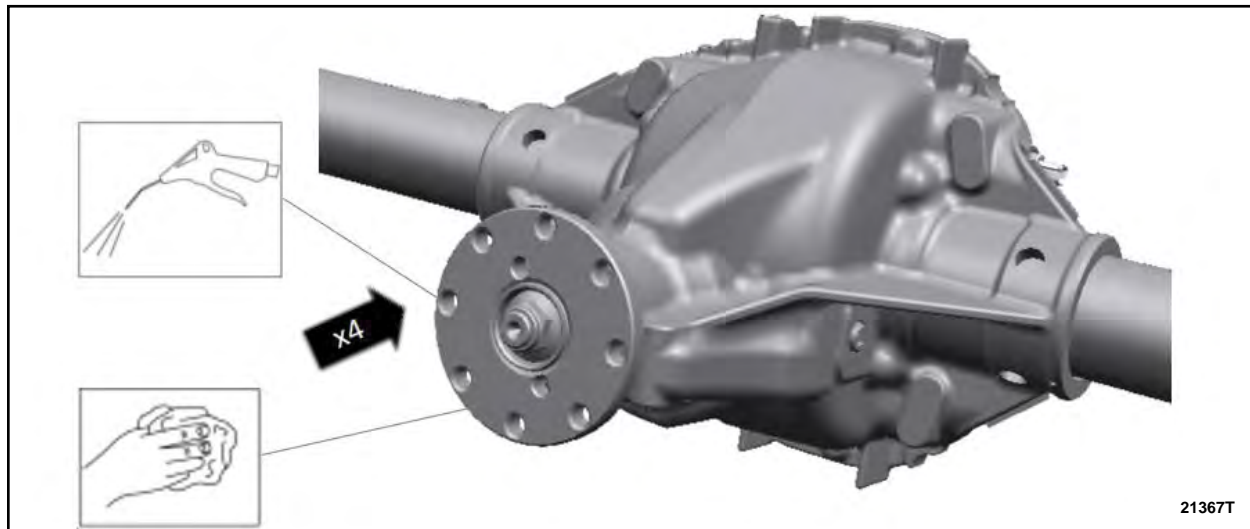

**FIGURE 15**

23. Inspect the original driveshaft flange to pinion flange bolts for rust in the threads and replace if rusted or damaged. Clean threads of the original driveshaft flange to pinion flange bolts with a wire brush and coat the threads with LOCTITE 243 Blue Medium Strength Threadlocker or equivalent. See Figure 16.

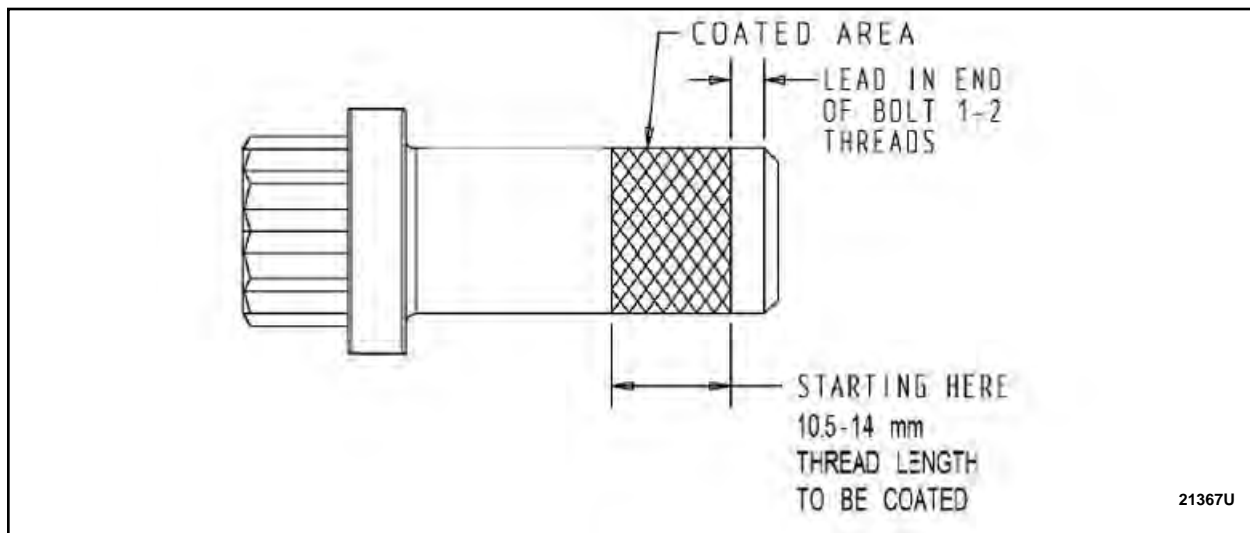

**FIGURE 16**

24. Install the driveshaft. Please follow WSM procedures in Section 205-01.





Appendix A – Acceptable Photos



FIGURE 17

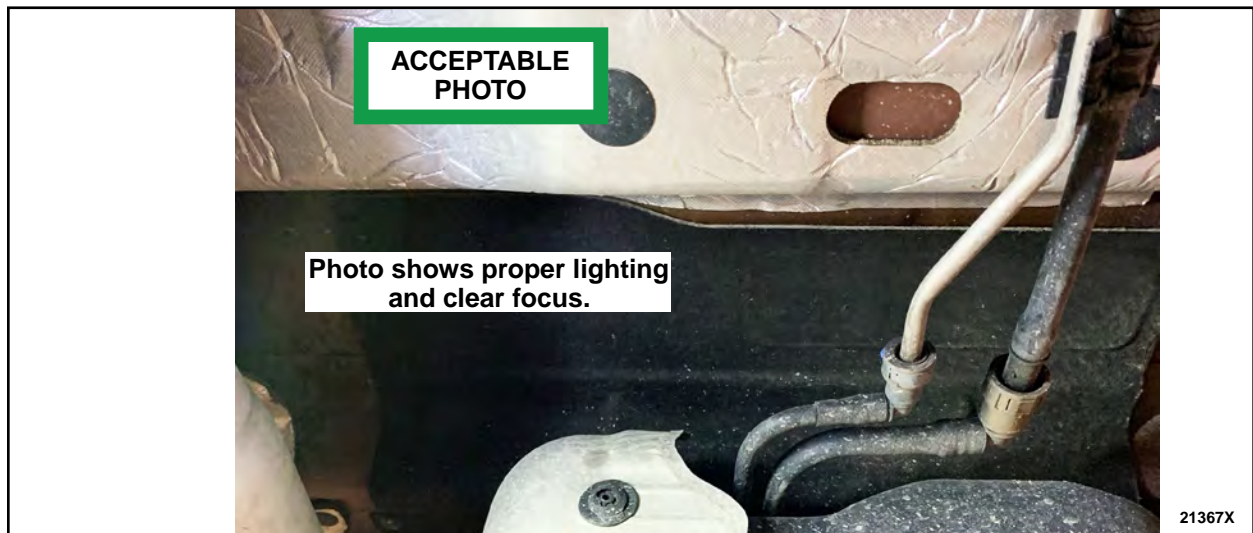

FIGURE 18



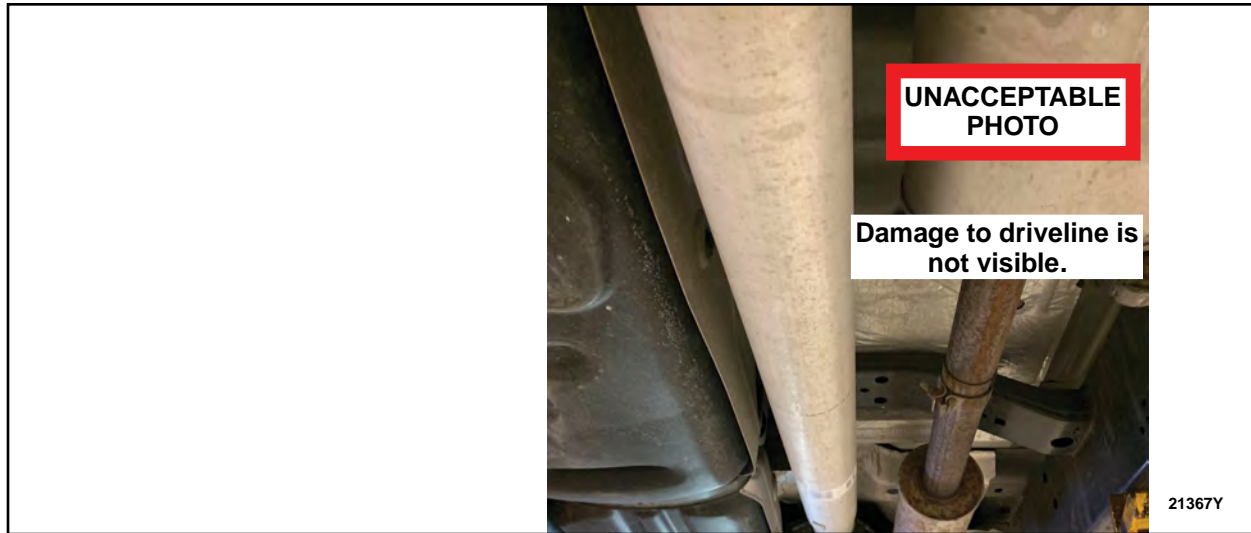

FIGURE 19



FIGURE 20

