

## For Subaru Field Service Engineer Use ONLY

**Applicability:** 2019MY Ascent

**Number:** WRK-21

**Subject:** TR690 Chain Guide Inspection / TCM Reprogramming

**Date:** 4/15/22

**Introduction:** This Service Campaign focuses on inspection of the CVT chain guide and reprogramming of the TR690 Transmission Control Module (TCM). The chain guide may be damaged as a result of chain slippage. Outlined below is an inspection procedure and the correct courses of action to be taken depending on the inspection result.

### Part Information:

Model	Part Description	Part Number	Quantity
Ascent with CVTF Cooler	CVT Assembly	31000AK130	1
Ascent Without CVTF Cooler	CVT Assembly	31000AK140	1
All	GSKT-16.3X22X1.0	803916100	1
	Subaru Extra MT	SOA748V0100	As Needed

**NOTE:** The plug gasket **803916100** is required for the inspection process.

CVTF				
Model	Transmission Fluid	Part Number	Quantity/Unit/Pack	Warranty Part #
Ascent	High Torque CVTF-LV	SOA748V0300	5 Gallon Pail	SOA635312
		SOA748V0310	16 Gallon Keg	

### Additional Required Tools:

- **CRITICAL:** ONLY a Videoscope Kit **PROVIDED BY SOA** is the **ONLY** scope that can be used for this inspection. NO other scopes are to be used for chain inspection.
  - The **OTC 16-3880X Videoscope** has a removable tip. It is suggested to add thread lock to ensure the tip is not lost during inspection.
  - The **Autel MV400-5.5** has a removable tip. This tip **MUST** be removed prior to inspection. This action will ensure the proper holder/scope fitment.
- **Holder 18361AA090:** This specialty plug is used in conjunction with the OTC 16-3880X Videoscope Kit. It sets the position of the scope's camera to provide an optimum inspection of the chain guide affected area .



## For Subaru Field Service Engineer Use ONLY

**IMPORTANT NOTE:** When the FSEs receive their OTC 16-3880X Videoscope Kits , they should SAVE THE PACKAGING so, when they have completed their “list” of affected vehicles, they can reuse it to ship the scope back to **SOA**.

### Requirements:

A Quality Monitoring Report (QMR) submission is required on all vehicles regardless of outcome. The QMR MUST include the following:

1. SSM4 Data files.
2. Clear photo of the transmission serial number.

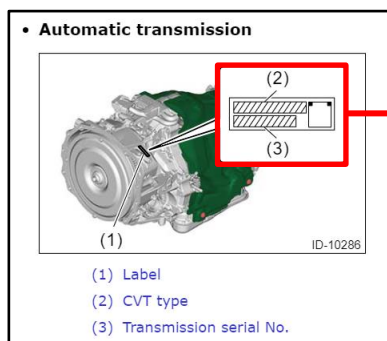

3. Clear photo of the inspection scope images (if scope inspection is required).



4. A clear screenshot or photo of the “Slip A” Information displayed on SSM4.

	Item	Value	Unit	Maximum	Minimum	Average
<input type="checkbox"/>	Drive Test	No request		-	-	-
<input type="checkbox"/>	Slip A Information	1		1	1	1

## For Subaru Field Service Engineer Use ONLY

### Service Procedure / Information:

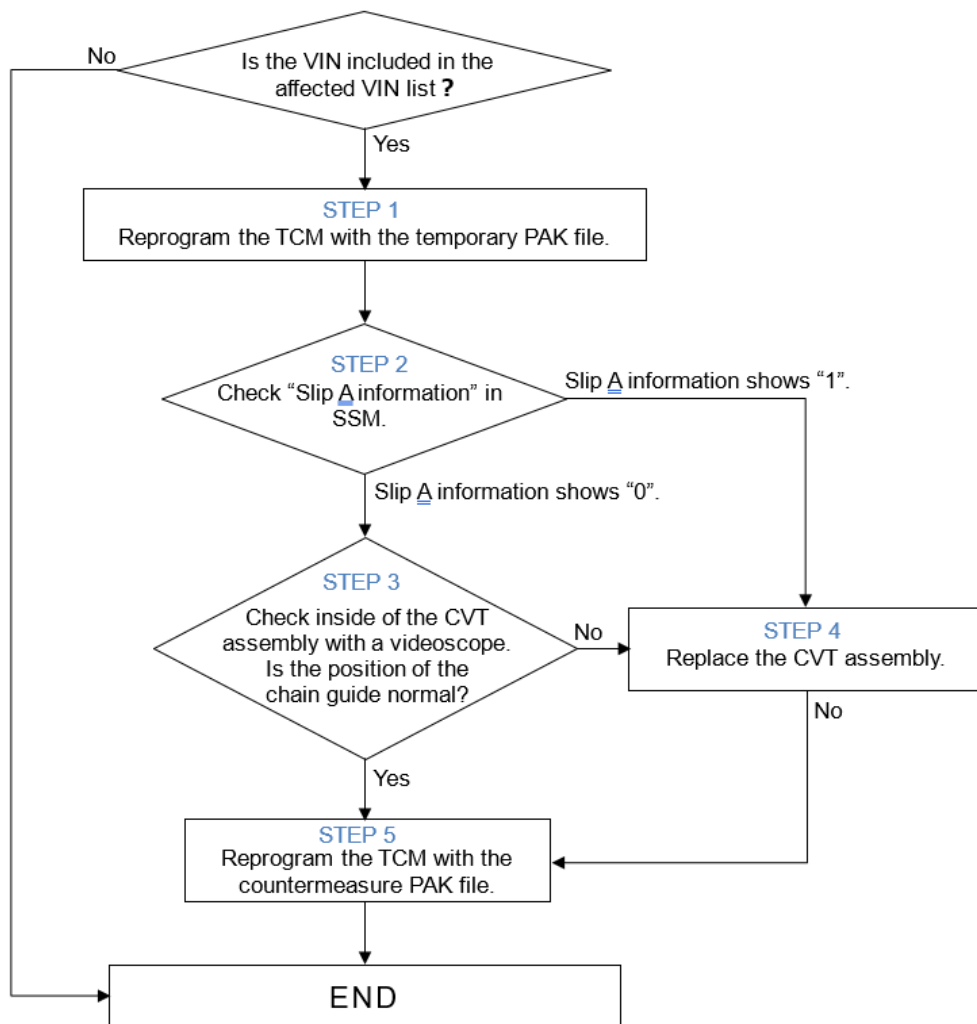

**STEP 1-A:** Reprogram the Transmission Control Module (TCM) with the **TEMPORARY** PAK file.

TEMPORARY PAK FILES							
Model	MY	Specification	PAK File Name	New ECU Part #	Old ECU Part #	Decryption Keyword	New CID Number
ASCENT	19	2.4L DIT CVT without CVTF cooler	QMBT-0109_30919AF98D.pak	30919AF98D	30919AF98A 30919AF98B 30919AF98C 30919AF98D	F6C70FD8	R8FEE800
		2.4L DIT CVT with CVTF cooler	QMBT-0109_30919AF99D.pak	30919AF99D	30919AF99A 30919AF99B 30919AF99C 30919AF99D	9D2EE2D9	R8FEF800

**NOTE:** See **Appendix A** for additional information regarding control module reprogramming.

# For Subaru Field Service Engineer Use ONLY

**STEP 1-B:** Display the following data using the Subaru Select Monitor (SSM4).

- Switch the ignition switch to the OFF position and wait 30 seconds, then switch to the ON position.
- **IMPORTANT:** Restart the SSM application after the TEMPORARY pak file is installed.
- Verify the VIN information and select “Diagnosis”.
- Select “Target Each System.”
- Select “Transmission” then select “Data Monitor”.

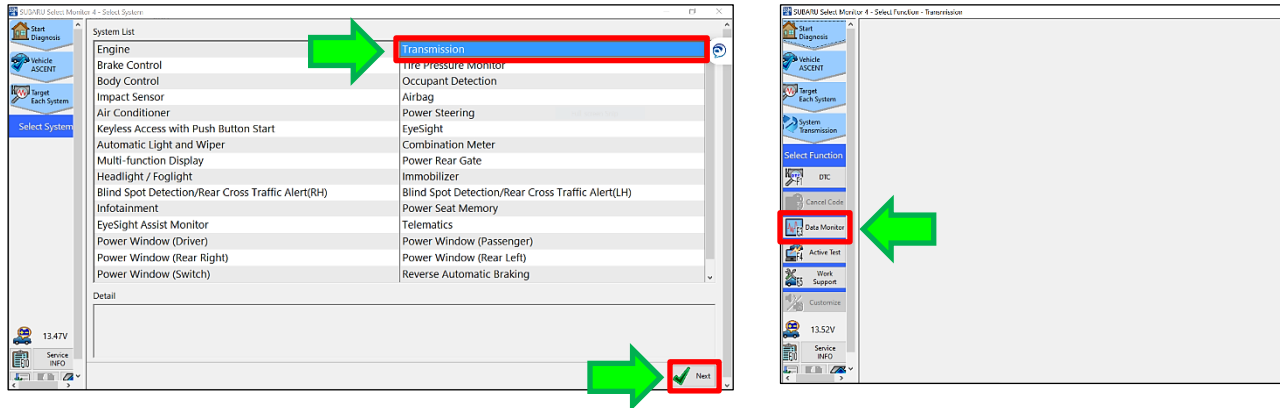

- Scroll through the select signal list and confirm the “Slip A Information” item is selected (Blue Highlighted). Once the item is highlighted, click the “Add” button.

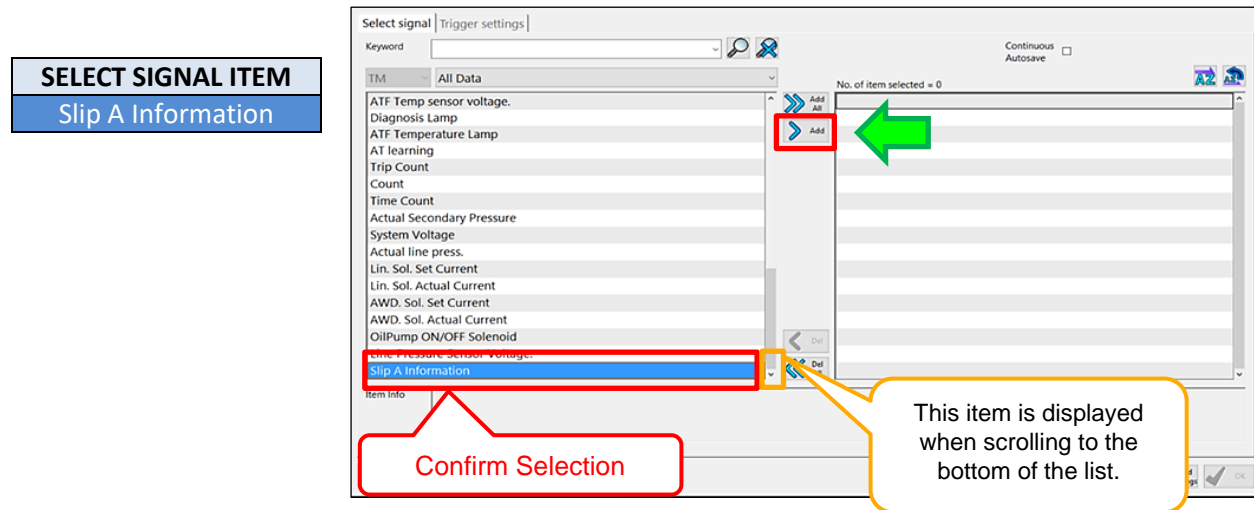

**IMPORTANT:** In the case of failed control module communication with SSM after the installation of the temporary pak file, check and confirm the interface setting is matched to the equipment being used (SDI, DSTI, & DST 010).

## For Subaru Field Service Engineer Use ONLY

- Confirm the selection is now transferred to the column on the right side. Continue by clicking the “OK” button.

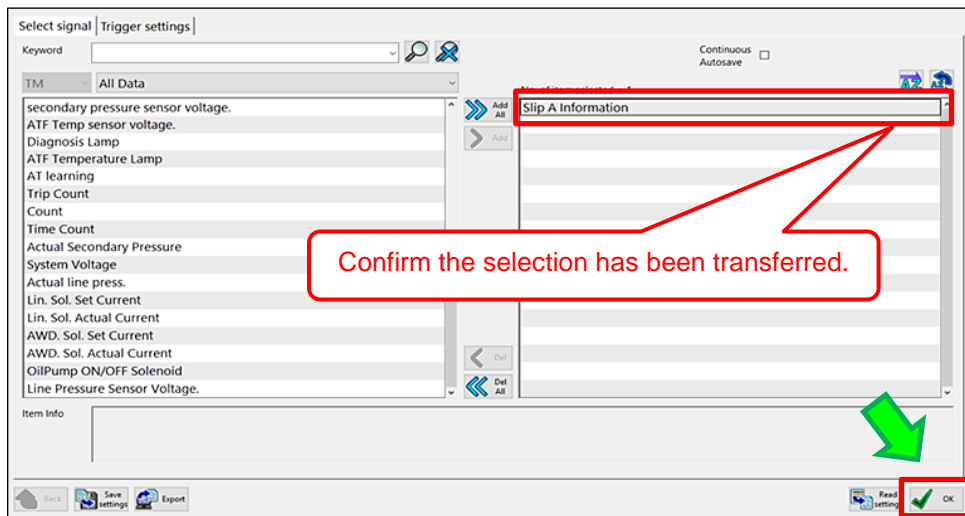

**SELECT SIGNAL ITEM**  
Slip A Information

### STEP 2A: Review the “Slip A Information” value.

- If CVT chain slip has been detected, the value of “Slip A Information” will display a value of one.
- If the CVT chain slip has Not been detected, the value of “Slip A Information” will display a value of zero.

Check item	Value	Result	Next step
Slip A Information	0	CVT is OK.	Go to <b>STEP 3</b>
	1	Replace CVT with a new one.	Go to <b>STEP 4</b>

## For Subaru Field Service Engineer Use ONLY

**STEP 3A:** Disconnect the vehicle from the SSM at this time. Remove the 10mm bolt retaining the insulator cover on the right side of the CVT.

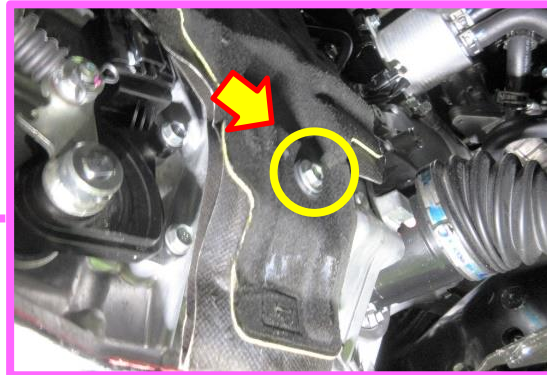
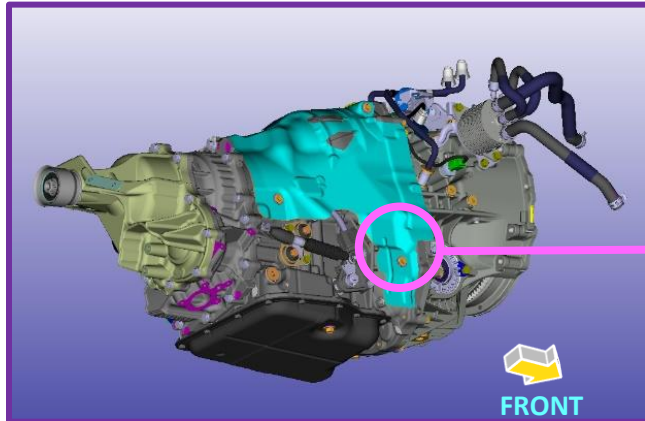

**STEP 3B:** **CAREFULLY** lift the insulation only as far as necessary to expose the plug as shown below.

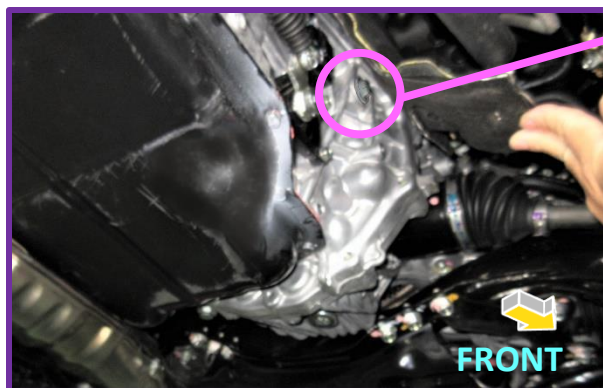
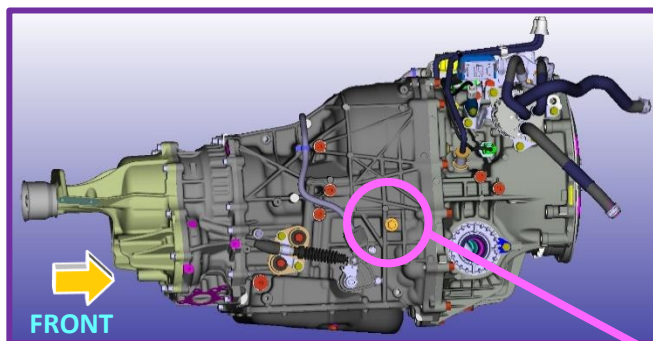

## For Subaru Field Service Engineer Use ONLY

**STEP 3C:** Install and align the specialty plug / holder (18361AA090) as shown below.

- The holder is designed to provide the proper insertion angle for the videoscope camera.
- Install the tool by tightening the holder down **BY HAND ONLY**.
- Slightly loosen the holder so the flat section of the tool is facing downward (parallel to the floor). See the example illustrations below.

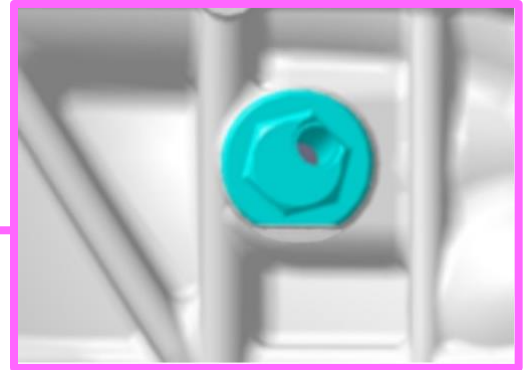
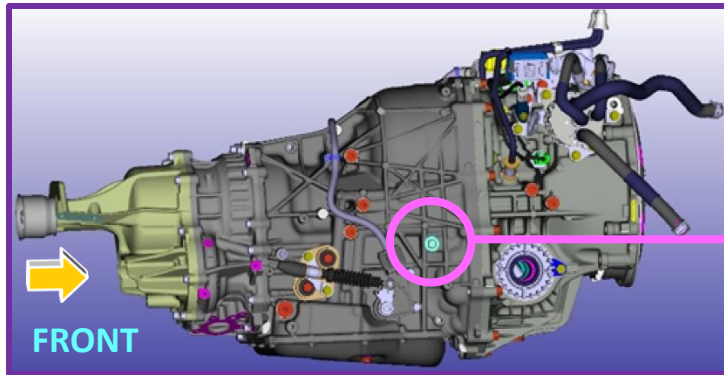

**Flat Section of the Holder  
18361AA090**



**NOTE:** **NEVER** use any wrench, socket, etc. when tightening the plug / holder tool. Teflon Tape can be applied to the holder threads for added stability.

**STEP 3D:** Perform a visual inspection of the chain guide rail.

- Make sure the OTC threaded camera tip is screwed on tight prior to usage. Prepare the videoscope camera by measuring and marking approximately 5mm (0.2inch) from where the metal section of the scope tip meets the flexible portions. This section can be marked using a marker or tape. Use the example photos below as a guide.



**5mm (Approx. 0.2 Inch)**

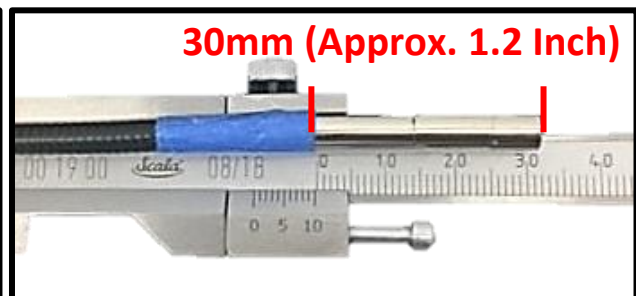

**30mm (Approx. 1.2 Inch)**

## For Subaru Field Service Engineer Use ONLY

- Identify the top section of the scope camera lens while performing a function test of the scope. This can help for the scope view positioning.
- Insert the scope camera into the plug / holder up to the previously marked line.

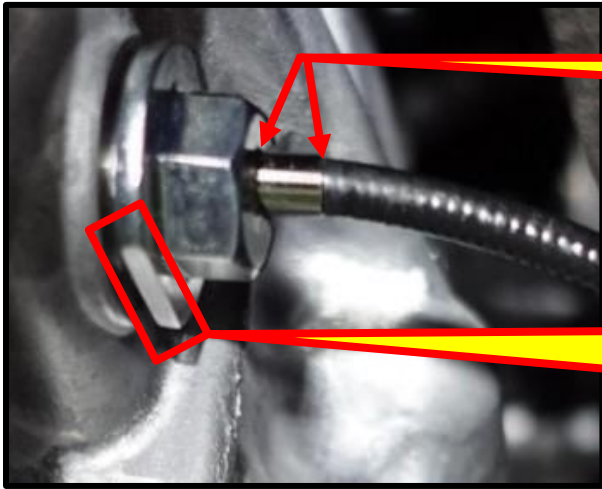

**5mm (Approx. 0.2 inch)**

**Maintain the "Parallel to the Floor" Position of the Plug / Holder Tool**

- Set the magnification of the videoscope to 1.0.





**For Subaru Field Service Engineer Use ONLY**

**STEP 3E:** Inspect the position of the lower end of the chain guide rail and the drive pinion shaft.

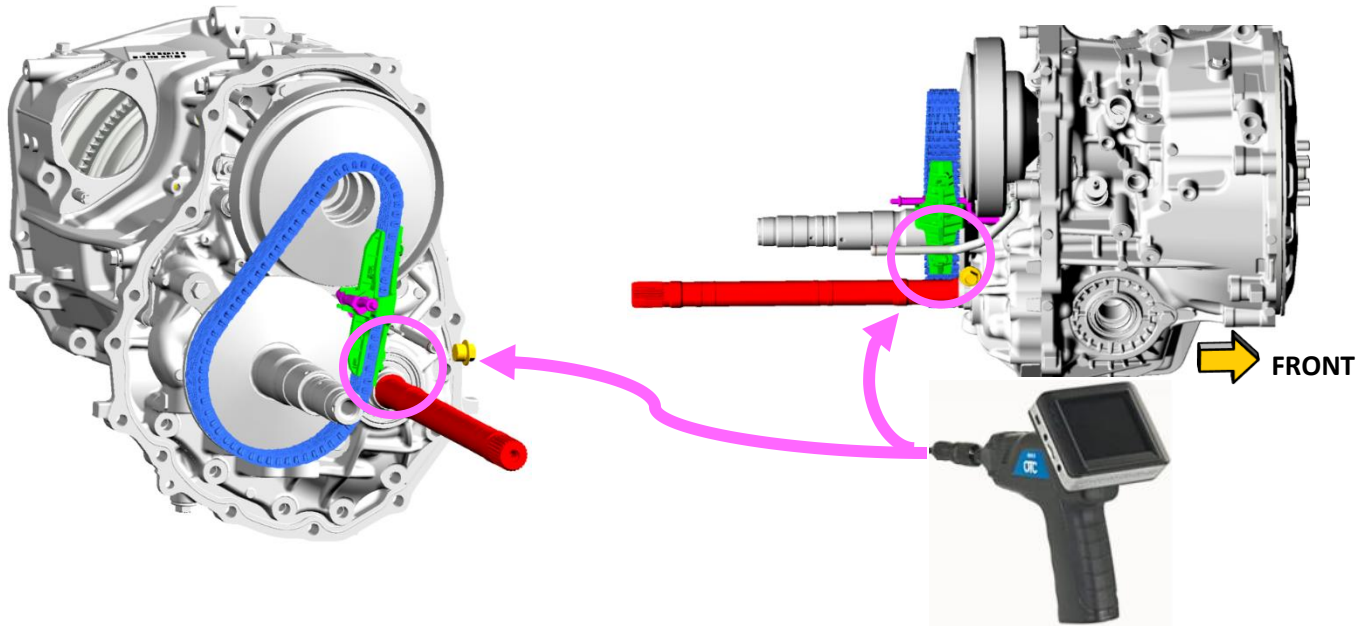

**CORRECT GUIDE POSITIONING:**

The chain guide is properly engaged with the guide pin.

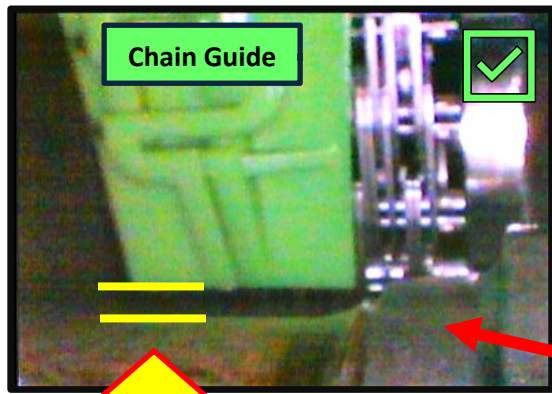

Here, the gap between the guide and pinion shaft is narrow and the guide is **PARALLEL** to the drive pinion shaft.

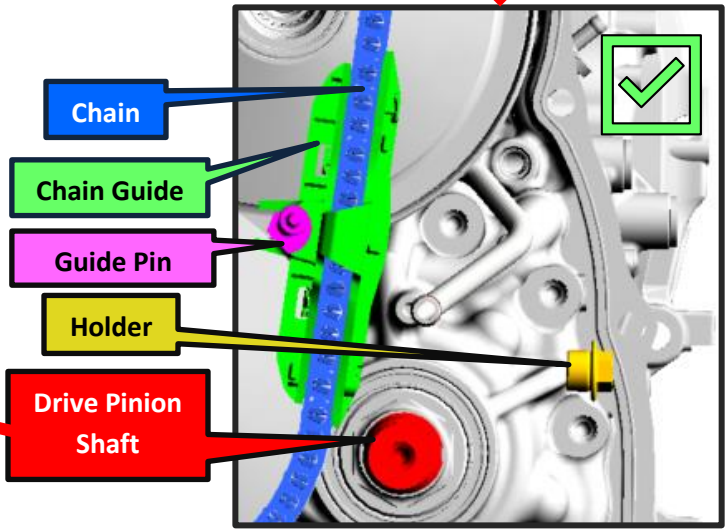

**For Subaru Field Service Engineer Use ONLY**

**INCORRECT GUIDE POSITIONING 1:**

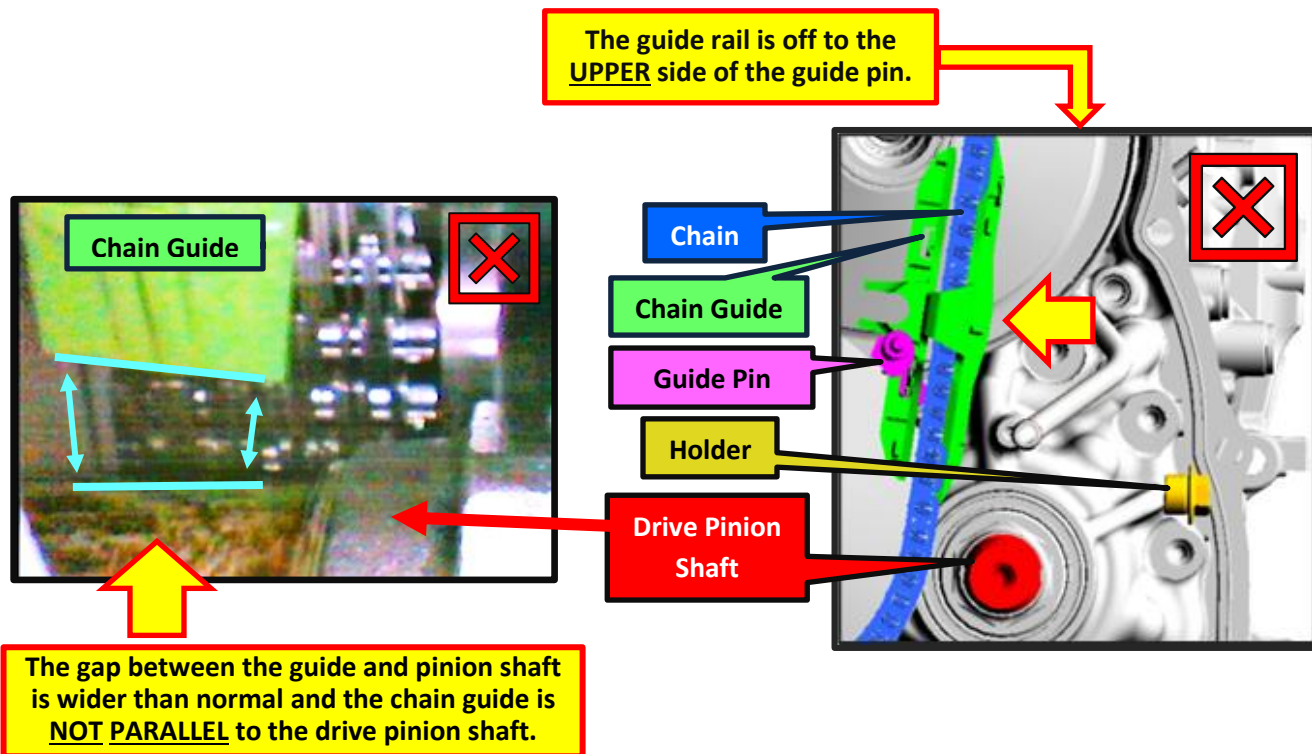

**INCORRECT GUIDE POSITIONING 2:**

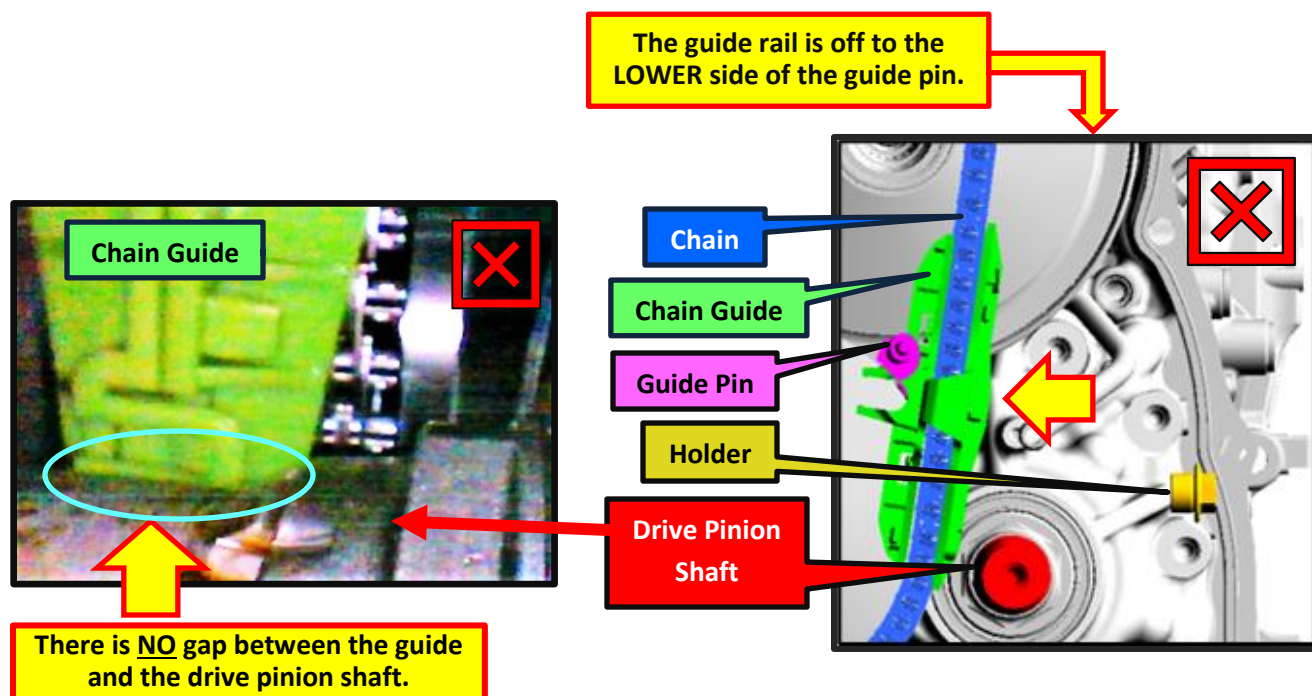

## For Subaru Field Service Engineer Use ONLY

**STEP 3F:** Remove the holder (18361AA090).

- Reinstall the original plug with a **NEW gasket**.  
**Tightening torque: 35 N·m (25.8ft-lbs.)**
  
- Install the bolt retaining the insulator cover.  
**Tightening torque : 8 N·m (5.9ft-lbs.)**

**STEP 3G:** Using the inspection results from **STEP 3E**, use the table below to determine the next course of action.

Result	Next step
<b>CORRECT POSITION</b>	Proceed to <b>STEP 10</b>
<b>INCORRECT POSITION 1 OR 2</b>	Proceed to <b>STEP 9</b>

**STEP 4A:** Replace the CVT assembly.

The service procedures for CVT assembly replacement remain unchanged. Always refer to the applicable Service Manual and review the full requirements of the repair being performed. The Service Manual procedures contain information critical to performing an effective repair the first time, every time. This includes but is not limited to important SAFETY precautions, proper inspection criteria, necessary special tools, required processes and related one-time-use parts needed for a complete and lasting repair.

**Refer to STIS:** Transmission/Transaxle > CONTINUOUSLY VARIABLE TRANSMISSION > Transmission Assembly > Removal/Installation

**STEP 4B:** Proceed to **STEP 5**.

**STEP 5:** Reprogram the Transmission Control Module (TCM) with the **CORRECTION** PAK file.

WRK-21 CORRECTION PAK FILES							
Model	MY	Specification	PAK file name	New ECU Part #	Old ECU Part #	Decryption Keyword	New CID Number
ASCENT	19	2.4L DIT CVT without CVTF cooler	30919AF98D.pak	30919AF98D	30919AF98D	E4C281C7	R8FEE900
		2.4L DIT CVT with CVTF cooler	30919AF99D.pak	30919AF99D	30919AF99D	019C3F2F	R8FEF900

**NOTE:** See **Appendix A** for additional information regarding control module reprogramming.

**CAUTION:** Confirm the ATF oil temp warning light stays off after all reprogramming has been performed.

## For Subaru Field Service Engineer Use ONLY

### CALIFORNIA “VEHICLE EMISSION RECALL - PROOF OF CORRECTION” CERTIFICATE

The California Air Resources Board and the Department of Motor Vehicles Registration/Recall Program requires that all emission related Recall/Campaign or Service Program repairs be completed before a vehicle registration is renewed. Please provide owners of vehicles registered in the state of California a completed “Vehicle Emission Recall - Proof of Correction” certificate. Vehicle owners should be advised to retain this certificate because the California Department of Motor Vehicles may require they provide proof this service program repair has been completed. Additional certificates are available through normal parts ordering channels using part number MSA6P1301. Quantity 1 = 1 booklet of 50 certificates.

### SERVICE PROGRAM IDENTIFICATION LABEL:

Type or print the necessary information on a Campaign Identification Label. The completed label should be attached to the vehicle’s upper radiator support. Additional labels are available through normal parts ordering channels. The part number is **MSA6P1302**, which comes as one sheet of 20 labels.

Part Number	Applicability	Description	Order Quantity
MSA6P1302	All Models	Campaign Completion Labels (contains one sheet of 20 labels)	1

**SUBARU**

Campaign Code

**WRK-21**

COMPLETED

DIST./DEALER NO.

SERIAL NO.

**DO NOT REMOVE**

## For Subaru Field Service Engineer Use ONLY

### Claim Reimbursement and Entry Procedures:

Credit to perform this recall will be based on properly completed repair order information. Retailers may submit claims through Subarunet.com.

**IMPORTANT:** The **FINAL** Calibration Identification number (CID) for the **CORRECTION** programming (not the testing file) **MUST** be noted on the repair order as this information is required for claim submission.

Labor Description	Labor Operation #	Labor Time	Fail Code	Claim Type
TCM REPROGRAMMING, SSM DATA CHECK & VEHICLE INSPECTION WITH VIDEOSCOPE	A103-008	1	WRK-21	RC
TCM REPROGRAMMING, SSM DATA CHECK & CVT ASSEMBLY REPLACEMENT	A103-000	5.3		
TCM REPROGRAMMING, SSM DATA CHECK, VEHICLE INSPECTION WITH VIDEOSCOPE & CVT ASSEMBLY REPLACEMENT	A103-010	5.5		

### IMPORTANT REMINDERS:

- SOA strongly discourages the printing and/or local storage of service information as previously released information and electronic publications may be updated at any time.
- Always check for any open recalls or campaigns anytime a vehicle is in for servicing.
- Always refer to STIS for the latest service information before performing any repairs.

# For Subaru Field Service Engineer Use ONLY

## Appendix A

**STEP 1:** Subaru of America, Inc. (SOA) highly recommends connecting either the Subaru Midtronics DCA-8000 Dynamic Diagnostic Charging System or the Subaru Midtronics GR8-100 Diagnostic Battery Charger to the vehicle and utilizing the Power Supply Mode feature to supply a stable **13.5 volts** anytime a vehicle control module is being reprogrammed.

Once the Midtronics charger is connected to the vehicle, **if the battery is fully charged**, it takes less than three (3) minutes to boot-up the charger, select the Power Supply Mode, and have the battery voltage stabilized and ready for reprogramming.

### NOTES:

- For instructions on using the power supply mode, reference the applicable User Manual for the Midtronics DCA-8000 Dynamic Diagnostic Charging System and the Midtronics GR8-1100 Diagnostic Battery Charger on STIS.
- Confirm all electrical loads such as lights, audio, HVAC, seat heaters, and rear defroster are all switched **OFF** before setting up the charger for Power Supply Mode.
- Select the correct battery type (Flooded, EFB, Gel, AGM or AGM Spiral).
- Input the CCA which matches the vehicle's battery. **NOTE:** OE and replacement batteries have different CCA ratings. Always confirm the battery's CCA rating before proceeding.
- If using a DCA-8000 Dynamic Diagnostic Charging System, set the power supply voltage to 13.5 volts.
- **DO NOT** connect the DST-I, DST 010, or SDI until the Power Supply mode function has completed its battery test mode and the Charging Voltage has dropped to and shows a steady 13.5 Volts on the display.
- Once Power Supply Mode reaches a steady **13.5 volts**, connect the DST-I, DST 010, or SDI to the OBD connector and proceed with initiating the normal FlashWrite reprogramming process.
- Amperage will fluctuate based upon the vehicle's demand for power. **NOTE:** If the voltage rises beyond 14V while programming is in process, the procedure will abort. This can indicate a need to test or charge the vehicle battery before any further attempt at programming is made.

### VERY IMPORTANT:

This information is applicable to the Subaru Midtronics DCA-8000 Dynamic Diagnostic Charging System and the Subaru Midtronics GR8-1100 Diagnostic Battery Charger **ONLY**. It does not apply to any other brand / type of "generic" battery charger whatsoever. **ONLY** the DCA-8000 and the GR8-1100 and their Power Supply Mode feature have been tested and approved by SOA.

**REMINDER:** If the DCA-8000 or GR8-1100 indicates the vehicle's battery must be charged, charge it fully using the DCA-8000 or GR8-1100 before proceeding to reprogram the vehicle using the Power Supply Mode.

### NOTES:

- Control module failures resulting from battery discharge during reprogramming are not a matter for warranty. Should any DTCs reset after the reprogramming update is performed, diagnose per the procedure outlined in the applicable Service Manual.

## For Subaru Field Service Engineer Use ONLY

- **IMPORTANT:** The **FINAL** Calibration Identification number (CID) for the **CORRECTION** programming (not the testing file) **MUST** be noted on the repair order as this information is required for claim submission.
- The testing and correction pack file listings provided in this bulletin are the latest available at the time of publishing. Updates are often released thereafter without revision to the original bulletin. For this reason, it is critical to always have the latest version of Select Monitor software installed on your system. You can confirm if a later version is available by entering the CID listed in this bulletin into FlashWrite. If a newer CID is shown as available in FlashWrite, reprogram using that file.
- AT Learning Procedure is **ONLY** required with CVT replacement.

**STEP 2: (ONLY IF CVT HAS BEEN REPLACED)** Using the SSM4, clear the AT Learning Data using the following procedure:

- Start > Diagnosis > Vehicle Selection > Each System > Transmission > Work Support > Clear AT Learning Data.
- Click “YES” and when “Execute Clear AT Learning” is displayed, click “YES” again.
- Turn the ignition OFF, wait at LEAST 30 seconds then turn the ignition back ON. At this point, the AT Temp light will start blinking; 4 times in 2 seconds to signify the Clear AT Learning procedure has completed successfully. If the AT Temp light does not flash as described, repeat Step 2 again from the beginning.