

## For Subaru Field Service Engineer Use ONLY

**Applicability:** 2019-20MY Ascent  
2020-21MY Legacy & Outback

**Number:** WRK-21

**Subject:** TR690 Chain Guide Inspection / TCM Reprogramming

**Date:** 1/24/22

**Introduction:** This Service Campaign focuses on inspection of the CVT chain guide and reprogramming of the TR690 Transmission Control Module (TCM). The chain guide may be damaged as a result of chain slippage. Outlined below is an inspection procedure and the correct courses of action to be taken depending on the inspection result.

**Part Information:**

Model	Part Description	Part Number	Quantity
Ascent with CVTF Cooler	CVT Assembly	31000AK130	1
Ascent Without CVTF Cooler	CVT Assembly	31000AK140	1
Legacy	CVT Assembly	31000AK270	1
Outback	CVT Assembly	31000AK280	1
ALL	GSKT-16.3X22X1.0	803916100	1

**NOTE:** The plug gasket **803916100** is required for the inspection process.

CVTF				
Model	Transmission Fluid	Part Number	Quantity/Unit/Pack	Warranty Part #
Legacy & Outback	High Torque CVTF-LV	SOA748V0300	5 Gallon Pail	SOA635312
Ascent		SOA748V0310	16 Gallon Keg	

**Additional Required Tools:**

- **Videoscope Kit** (provided by SOA): This scope is required for the chain guide inspection procedure. Each retailer will be shipped ONE of these kits when they become available.



**CRITICAL:** The Videoscope Kit **PROVIDED BY SOA** is the **ONLY** scope that can be used for this inspection. **NO** other scopes are to be used for chain inspection.

- **Holder 18361AA090:** This specialty plug is used in conjunction with the Videoscope Kit. It sets the position of the scope's camera to provide an optimum inspection of the chain guide affected area .



## For Subaru Field Service Engineer Use ONLY

### Service Procedure / Information:

**STEP 1-A:** Reprogram the Transmission Control Module (TCM) with the **TEMPORARY** PAK file.

TEMPORARY PAK FILES							
Model	MY	Specification	PAK File Name	New ECM Part #	Old ECM Part #	Decryption Keyword	New CID Number
ASCENT	19	2.4L DIT CVT <b>without</b> CVTF cooler	QMBT-0109_ 30919AF98D.pak	30919AF98D	30919AF98A 30919AF98B 30919AF98C 30919AF98D	343F77BD	R8FEE800
		2.4L DIT CVT <b>with</b> CVTF cooler	QMBT-0109_ 30919AF99D.pak	30919AF99D	30919AF99A 30919AF99B 30919AF99C 30919AF99D	94725282	R8FEF800
	20	2.4L DIT CVT <b>without</b> CVTF cooler	QMBT-0109_ 30919AH13E.pk2	30919AH13E	30919AH13A 30919AH13B 30919AH13C 30919AH13D 30919AH13E	474040BE	Q9FEE900
		2.4L DIT CVT <b>with</b> CVTF cooler	QMBT-0109_ 30919AH14E.pk2	30919AH14E	30919AH14A 30919AH14B 30919AH14C 30919AH14D 30919AH14E	84FD5C70	Q9FEF900
LEGACY	20-21	2.4L DIT CVT	QMBT-0109_ 30919AG75C.pk2	30919AG75C	30919AG75A 30919AG75B 30919AG75C	960FEB54	C7FEC740
OUTBACK	20-21	2.4L DIT CVT	QMBT-0109_ 30919AG76C.pk2	30919AG76C	30919AG76A 30919AG76B 30919AG76C	DEA0BDD9	C7FEF740

**NOTE:** See **Appendix A** for additional information regarding control module reprogramming.

**STEP 1-B:** Display the following data using the Subaru Select Monitor (SSM4).

- **IMPORTANT:** Restart the SSM application after the TEMPORARY pak file is installed.
- Verify the VIN information and select "Diagnosis".
- Select "Target Each System."

# For Subaru Field Service Engineer Use ONLY

- Select “Transmission” then select “Data Monitor”.

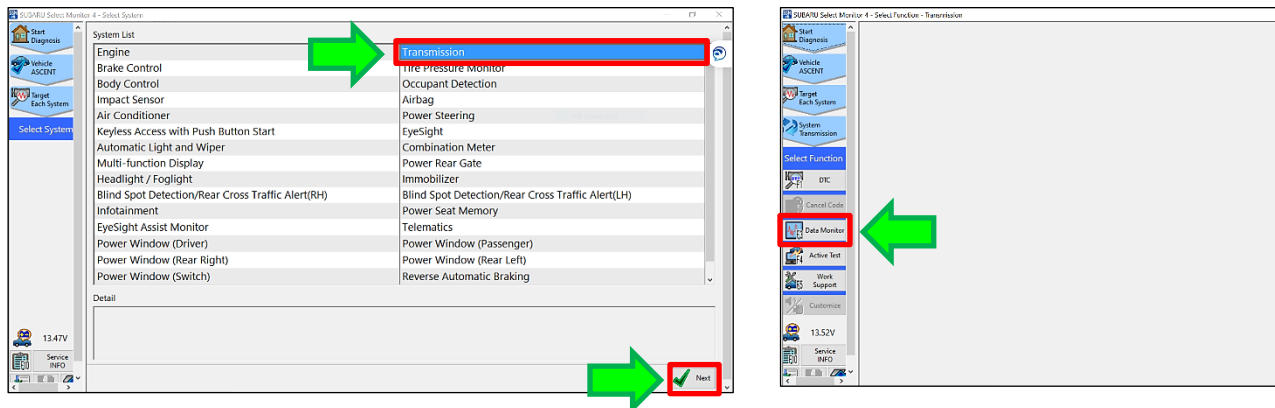

- Scroll through the select signal list and confirm the following items are selected (Blue Highlighted). Once all items are highlighted, click the “Add” button.

SELECT SIGNAL ITEMS
Run Confirmation
Slip A Information
Slip A Distance 1
Slip A Distance 2
Slip A Distance 3
Slip B Information
Slip B Distance 1
Slip B Distance 2
Slip B Distance 3

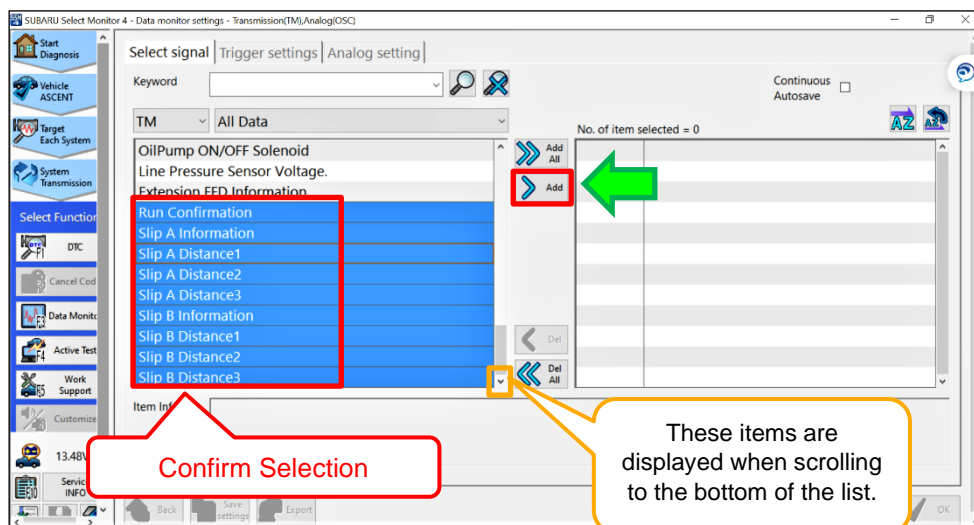

- Confirm the selections are now transferred to the column on the right side. Continue by clicking the “OK” button.

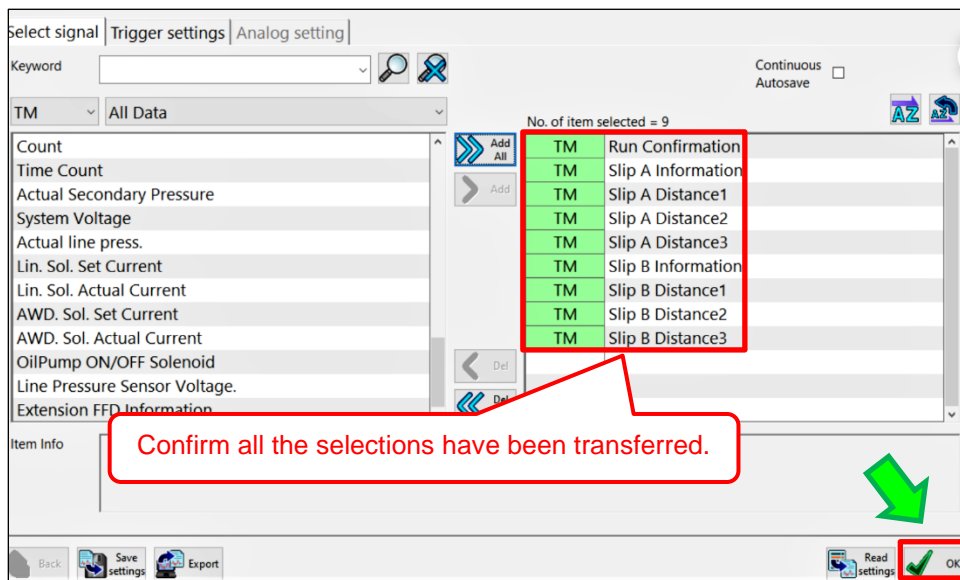

## For Subaru Field Service Engineer Use ONLY

**STEP 2A:** Review the “Slip A Information” & “Slip B Information” values.

- If CVT chain slip has been detected, the value of “Slip A Information” and/or “Slip B Information” will display up to three counts depending on the driving conditions.
- If the CVT chain slip has Not been detected, the value of “Slip A Information” and/or “Slip B Information” will display a count of zero.

**EXAMPLE:**

Item	Value	Unit
Run Confirmation	With Request	
Slip A Information	0	
Slip A Distance 1	0.0	Mile
Slip A Distance 2	0.0	Mile
Slip B Distance 3	0.0	Mile
Slip B Information	0	
Slip A Distance 1	0.0	Mile
Slip A Distance 2	0.0	Mile
Slip B Distance 3	0.0	Mile

**STEP 2A:** Apply the data values gathered from the **STEP 2A** to the table below to determine the next course of action.

Pattern	Monitor Items	Value	Result	Next Step
Pattern 1	Slip A Information	0	CVT chain slip has <b>NOT</b> been detected.	Proceed to <b>STEP 3</b>
	Slip B Information	0		
Pattern 2	Slip A Information	1, 2, or 3	CVT chain slip has been detected	Proceed to <b>STEP 4</b>
	Slip B Information	0		
Pattern 3	Slip A Information	0		
	Slip B Information	1, 2, or 3		
Pattern 4	Slip A Information	1, 2, or 3		
	Slip B Information	1, 2, or 3		

## For Subaru Field Service Engineer Use ONLY

**STEP 3A:** Check the “Run Confirmation” monitor item value.

**EXAMPLE:**

Item	Value	Unit
Run Confirmation	With Request	
Slip A Information	0	
Slip A Distance 1	0.0	Mile
Slip A Distance 2	0.0	Mile
Slip A Distance 3	0.0	Mile
Slip B Information	0	
Slip B Distance 1	0.0	Mile
Slip B Distance 2	0.0	Mile
Slip B Distance 3	0.0	Mile

**STEP 3B:** Apply the data values gathered from the **STEP 3A** to the table below to determine the next course of action.

Monitor Items	Value	Result	Next Step
Run Confirmation	With Request	Drive Test is necessary	Proceed to <b>STEP 6</b>
	No Request	Drive Test is <b>NOT</b> necessary	Proceed to <b>STEP 8</b>

**STEP 4A:** Check the vehicle history and determine if the CVT assembly has been previously replaced.

Has the CVT assembly has been previously replaced?

**YES** – Proceed to **STEP 5**

**NO** – Proceed to **STEP 9**

## For Subaru Field Service Engineer Use ONLY

**STEP 5A:** Review the Slip A & Slip B Distance data values.

- If CVT chain slip has been detected, the mileage will be recorded in any of the six mileage monitor items.
- If CVT chain slip is NOT detected, there will be a zero in all six mileage monitor items.

**EXAMPLE:**

Item	Value	Unit
Run Confirmation	No Request	
Slip A Information	1	
Slip A Distance 1	1500.1	Mile
Slip A Distance 2	0.0	Mile
Slip A Distance 3	0.0	Mile
Slip B Information	2	
Slip B Distance 1	0.0	Mile
Slip B Distance 2	43000.0	Mile
Slip B Distance 3	45001.0	Mile

**STEP 5B:** Compare the mileage of the latest CVT chain slip checked in **STEP 5A** with the mileage of the previous CVT assembly replacement.

Result	Next Step
<b>If the CVT assembly has been replaced after latest CVT chain slip.</b>	<b>STEP 8</b>
Result	Next Step
<b>If the CVT assembly has been replaced before the latest CVT chain slip.</b>	<b>STEP 9</b>

## For Subaru Field Service Engineer Use ONLY

**STEP 6:** Perform a road test under the conditions described below.

1. Move the gear selector to the D Range and **STOP** the vehicle.
2. **CAREFULLY** accelerate to 25 mph under **FULL** throttle then safely decelerate.



Proceed to **STEP 7**

**STEP 7A:** Switch the ignition switch to the OFF position and wait 30 seconds.

**STEP 7B:** Switch the ignition switch back to the ON position. Using SSM, check the displayed value of the “Slip A Information” monitor item.

**STEP 7C:** Apply the data values gathered from the **STEP 7B** to the table below to determine the next course of action.

Pattern	Monitor Items	Value	Result	Next Step
Pattern 1	Slip A Information	0	CVT chain slip has <b>NOT</b> been detected.	Proceed to <b>STEP 8</b>
	Slip B Information	0		
Pattern 2	Slip A Information	1, 2, or 3	CVT chain slip has been detected	Proceed to <b>STEP 9</b>
	Slip B Information	0		
Pattern 3	Slip A Information	0		
	Slip B Information	1, 2, or 3		
Pattern 4	Slip A Information	1, 2, or 3		
	Slip B Information	1, 2, or 3		

## For Subaru Field Service Engineer Use ONLY

**STEP 8A:** Disconnect the vehicle from the SSM at this time. Remove the 10mm bolt retaining the insulator cover on the right side of the CVT.

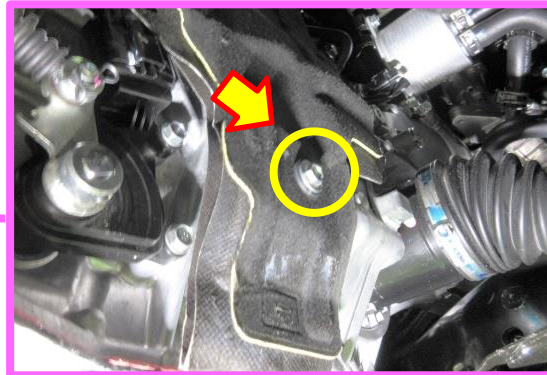
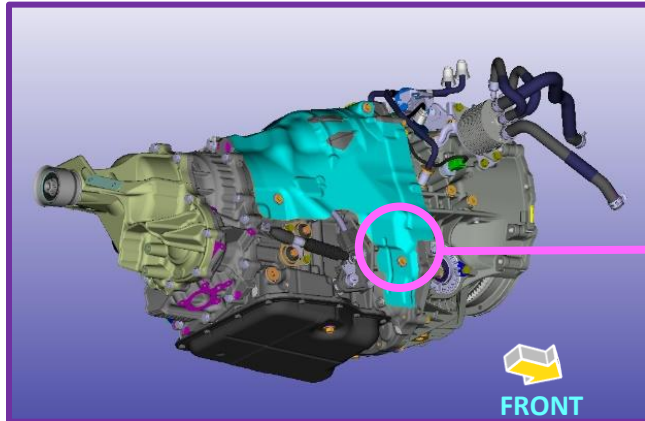

**STEP 8B:** **CAREFULLY** lift the insulation only as far as necessary to expose the plug as shown below.

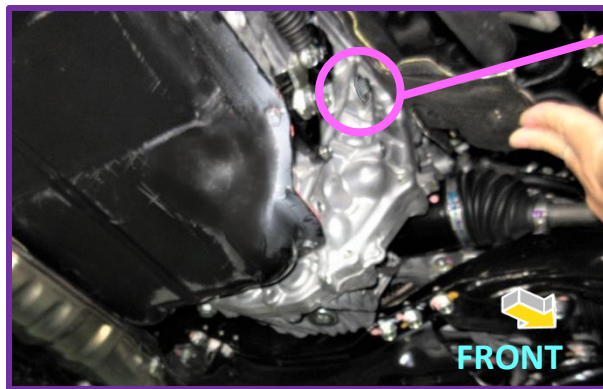
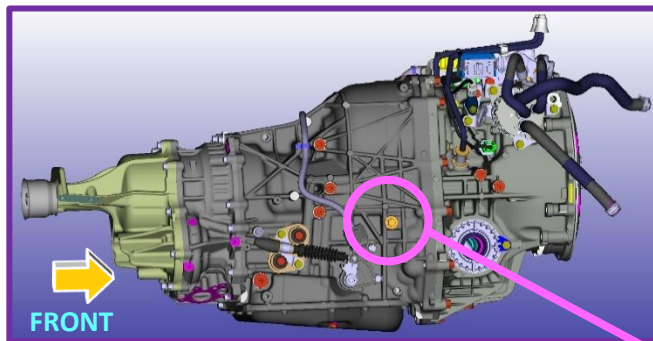



## For Subaru Field Service Engineer Use ONLY

**STEP 8C:** Install and align the specialty plug / holder (18361AA090) as shown below.

- The holder is designed to provide the proper insertion angle for the videoscope camera.
- Install the tool by tightening the holder down **BY HAND ONLY**.
- Slightly loosen the holder so the flat section of the tool is facing downward (parallel to the floor). See the example illustrations below.

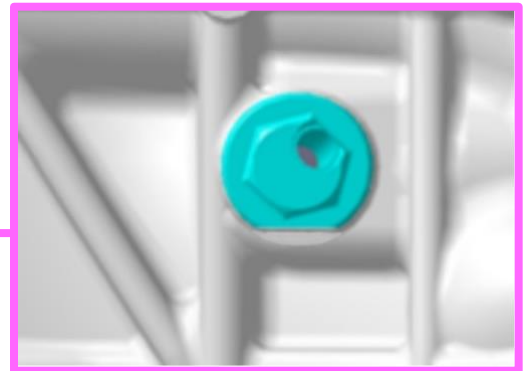
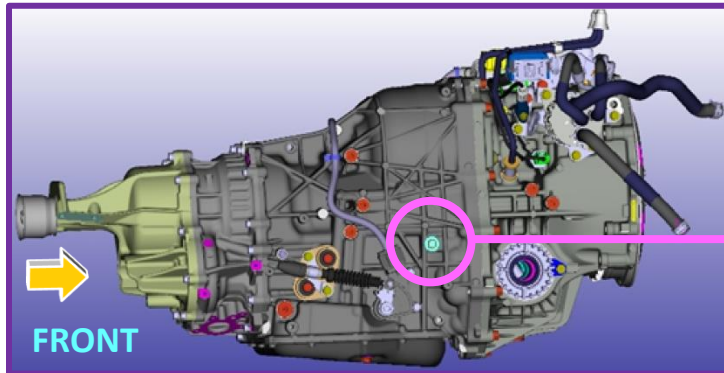

**Flat Section of the Holder  
18361AA090**



**NOTE:** **NEVER** use any wrench, socket, etc. when tightening the plug / holder tool.

**STEP 8D:** Perform a visual inspection of the chain guide rail.

- Prepare the videoscope camera by measuring and marking approximately 5mm (0.2inch) from where the metal section of the scope tip meets the flexible portions. This section can be marked using a marker or tape. Use the example photos below as a guide.



## For Subaru Field Service Engineer Use ONLY

- Identify the top section of the scope camera lens while performing a function test of the scope. This can help for the scope view positioning.
- Insert the scope camera into the plug / holder up to the previously marked line.

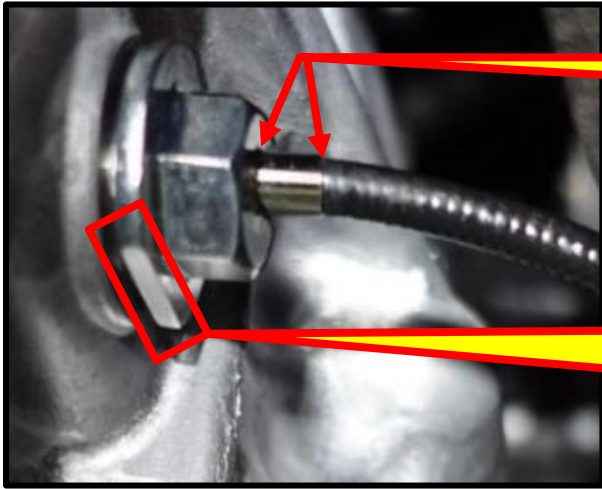

**5mm (Approx. 0.2 inch)**

**Maintain the “Parallel to the Floor” Position of the Plug / Holder Tool**

- Set the magnification of the videoscope to 1.0.



**For Subaru Field Service Engineer Use ONLY**

**STEP 8E:** Inspect the position of the lower end of the chain guide rail and the drive pinion shaft.

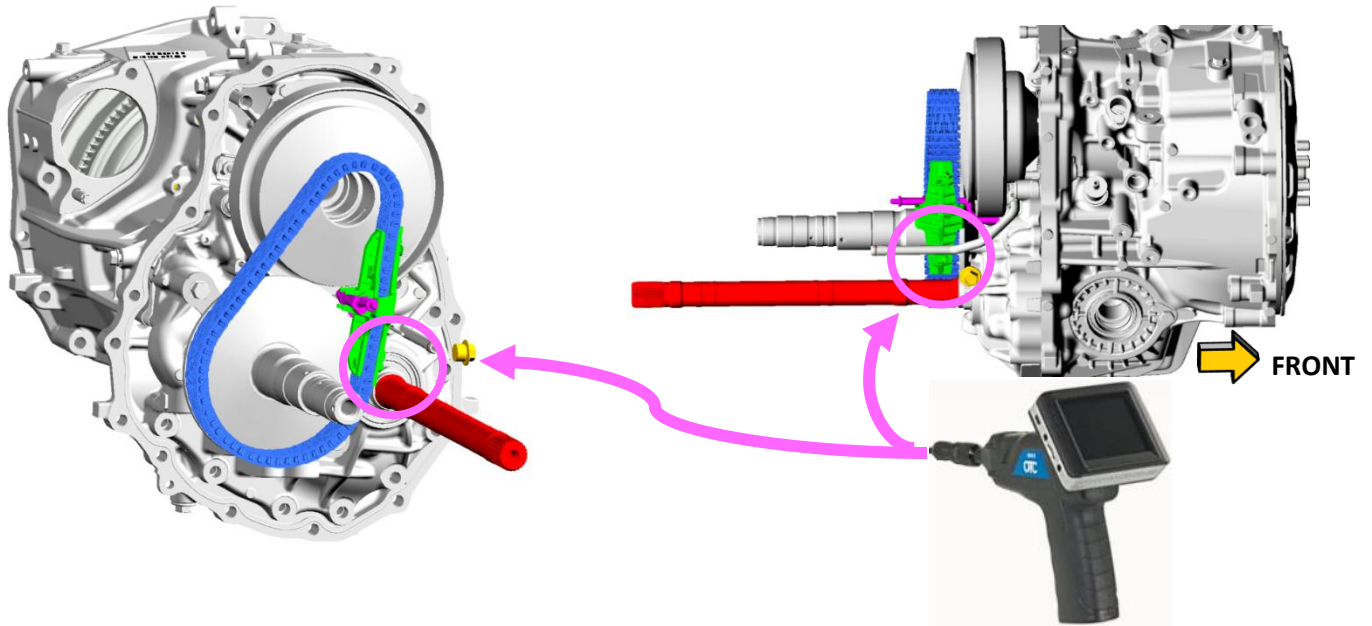

**CORRECT GUIDE POSITIONING:**

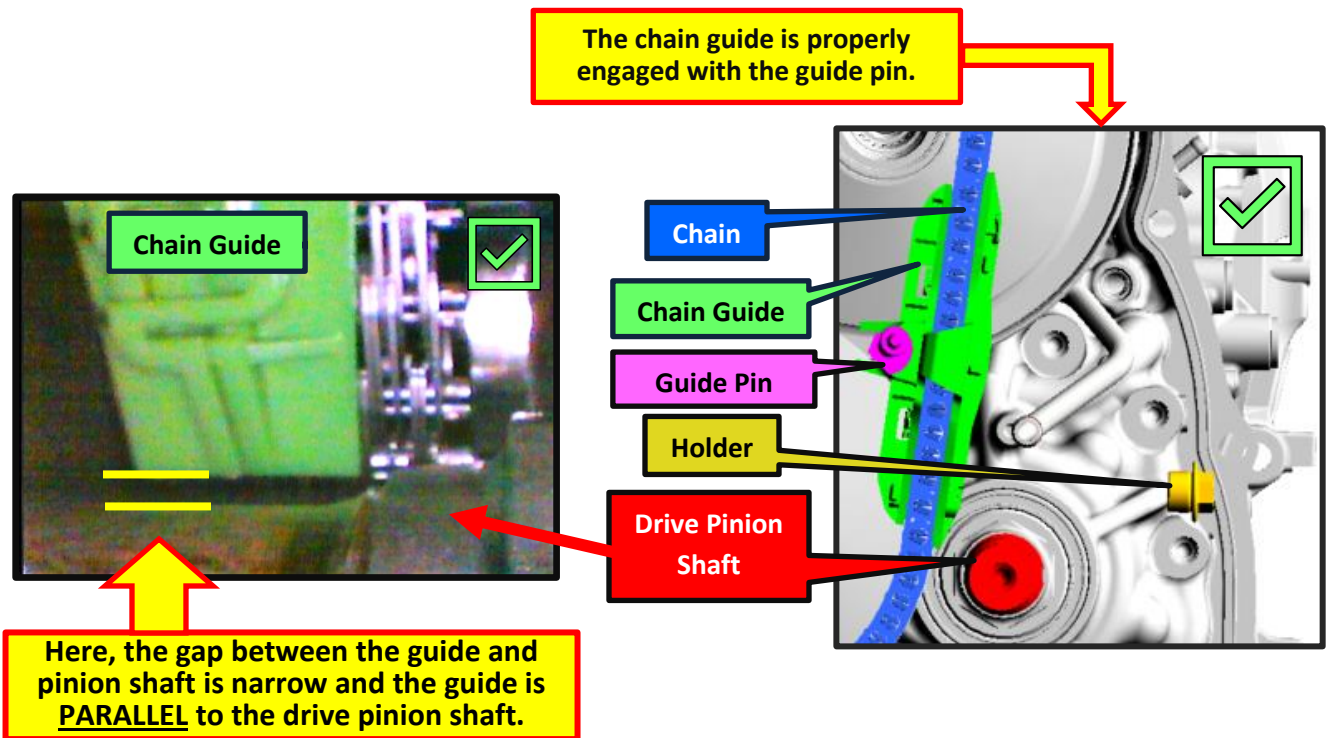

**For Subaru Field Service Engineer Use ONLY**

**INCORRECT GUIDE POSITIONING 1:**

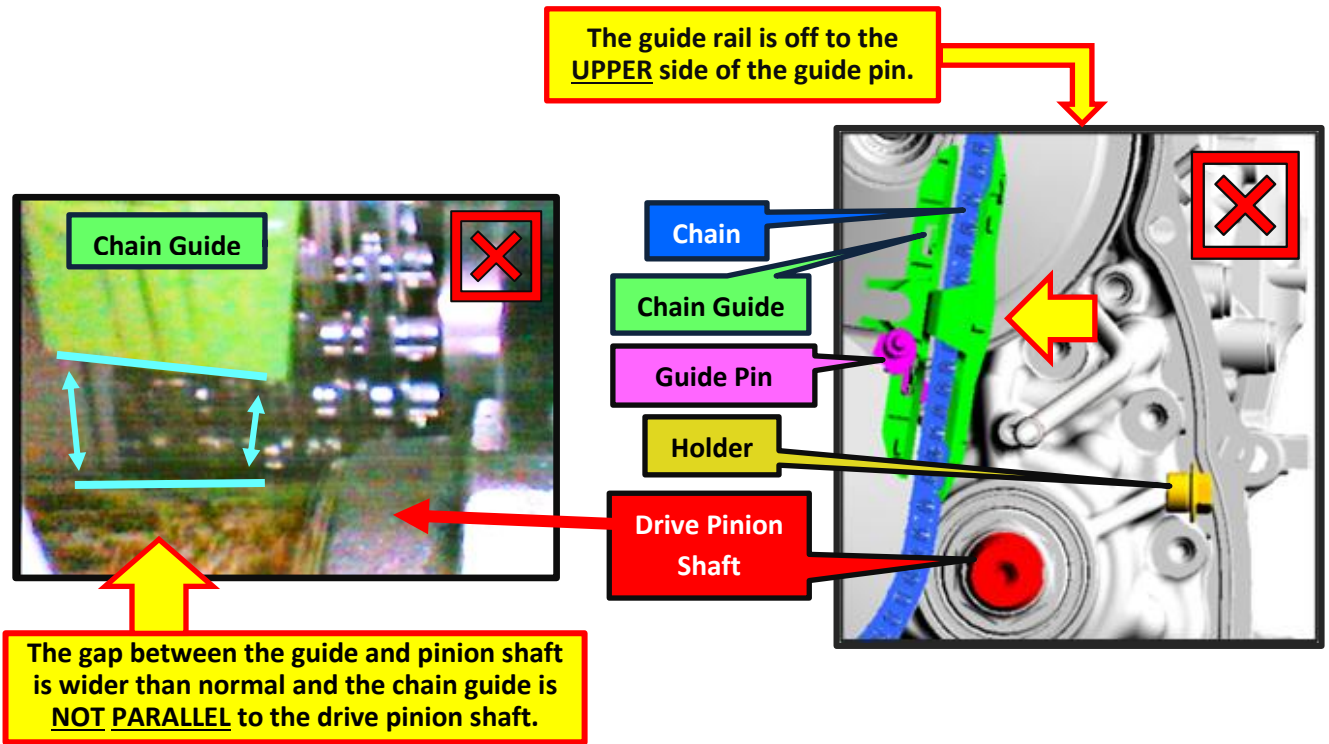

**INCORRECT GUIDE POSITIONING 2:**

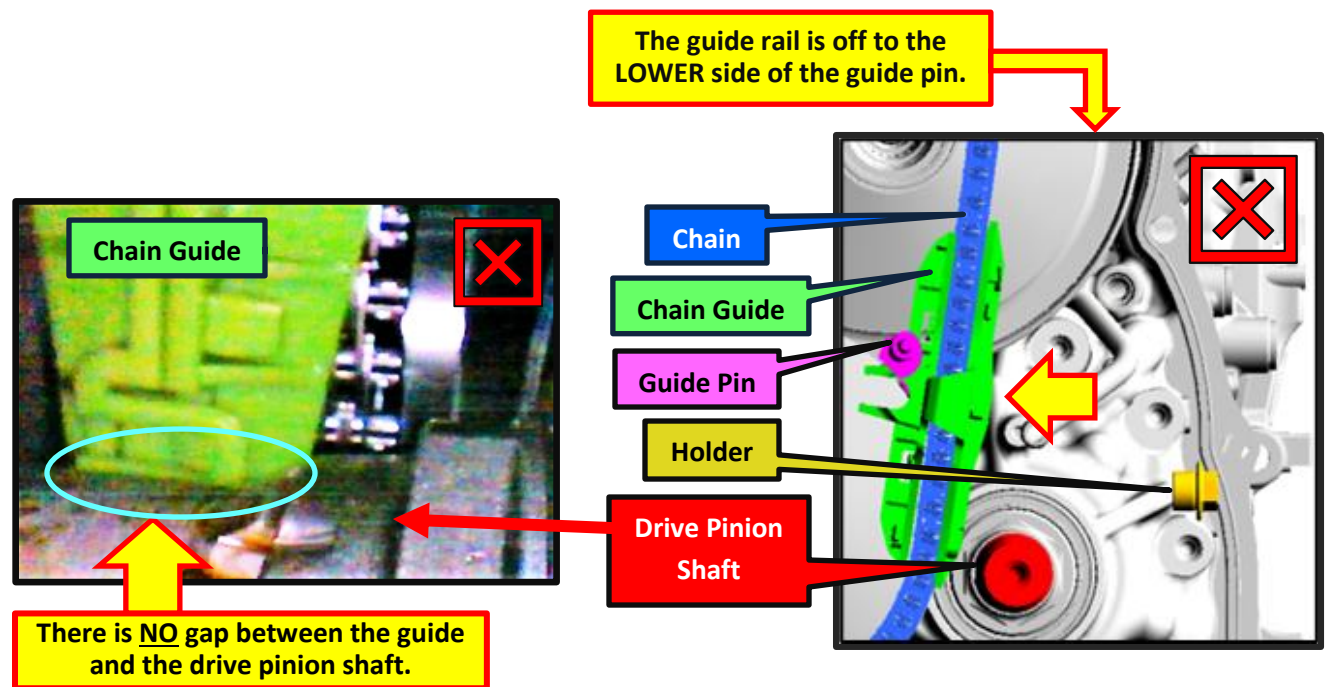

## For Subaru Field Service Engineer Use ONLY

**STEP 8F:** Remove the holder (18361AA090).

- Reinstall the original plug with a **NEW gasket**.  
**Tightening torque: 35 N·m (25.8ft-lbs.)**
  
- Install the bolt retaining the insulator cover.  
**Tightening torque : 8 N·m (5.9ft-lbs.)**

**STEP 8G:** Using the inspection results from **STEP 8E**, use the table below to determine the next course of action.

Result	Next step
<b>CORRECT POSITION</b>	Proceed to <b>STEP 10</b>
<b>INCORRECT POSITION 1 OR 2</b>	Proceed to <b>STEP 9</b>

**STEP 9A:** Replace the CVT assembly.

The service procedures for CVT assembly replacement remain unchanged. Always refer to the applicable Service Manual and review the full requirements of the repair being performed. The Service Manual procedures contain information critical to performing an effective repair the first time, every time. This includes but is not limited to important SAFETY precautions, proper inspection criteria, necessary special tools, required processes and related one-time-use parts needed for a complete and lasting repair.

**Refer to STIS:** [Transmission/Transaxle > CONTINUOUSLY VARIABLE TRANSMISSION > Transmission Assembly > Removal/Installation](#)

**STEP 9B:** Proceed to **STEP 10**.

**STEP 10:** Reprogram the Transmission Control Module (TCM) with the **CORRECTION** PAK file.

WRK-21 CORRECTION PAK FILES							
Model	MY	Specification	PAK file name	New ECM Part #	Old ECM Part #	Decryption Keyword	New CID Number
ASCENT	19	2.4L DIT CVT without CVTF cooler	30919AF98D.pak	30919AF98D	30919AF98D	8F890D29	R8FEE800
		2.4L DIT CVT with CVTF cooler	30919AF99D.pak	30919AF99D	30919AF99D	0340D26F	R8FEF800
	20	2.4L DIT CVT without CVTF cooler	30919AH13E.pk2	30919AH13E	30919AH13E	E84E7990	Q9FEE900
		2.4L DIT CVT with CVTF cooler	30919AH14E.pk2	30919AH14E	30919AH14E	42B81D46	Q9FEF900
LEGACY	20-21	2.4L DIT CVT	30919AG75C.pk2	30919AG75C	30919AG75C	E12DA33D	C7FEC740
OUTBACK	20-21	2.4L DIT CVT	30919AG76C.pk2	30919AG76C	30919AG76C	F615CC67	C7FEF740

**NOTE:** See **Appendix A** for additional information regarding control module reprogramming.

**CAUTION:** Confirm the ATF oil temp warning light stays off after all reprogramming has been performed.

## For Subaru Field Service Engineer Use ONLY

### CALIFORNIA “VEHICLE EMISSION RECALL - PROOF OF CORRECTION” CERTIFICATE

The California Air Resources Board and the Department of Motor Vehicles Registration/Recall Program requires that all emission related Recall/Campaign or Service Program repairs be completed before a vehicle registration is renewed. Please provide owners of vehicles registered in the state of California a completed “Vehicle Emission Recall - Proof of Correction” certificate. Vehicle owners should be advised to retain this certificate because the California Department of Motor Vehicles may require they provide proof this service program repair has been completed. Additional certificates are available through normal parts ordering channels using part number MSA6P1301. Quantity 1 = 1 booklet of 50 certificates.

### SERVICE PROGRAM IDENTIFICATION LABEL:

Type or print the necessary information on a Campaign Identification Label. The completed label should be attached to the vehicle’s upper radiator support. Additional labels are available through normal parts ordering channels. The part number is **MSA6P1302**, which comes as one sheet of 20 labels.

Part Number	Applicability	Description	Order Quantity
MSA6P1302	All Models	Campaign Completion Labels (contains one sheet of 20 labels)	1

**SUBARU**

Campaign Code

**WRK-21**

COMPLETED

DIST./DEALER NO.

SERIAL NO.

**DO NOT REMOVE**

## For Subaru Field Service Engineer Use ONLY

### Claim Reimbursement and Entry Procedures:

Credit to perform this recall will be based on properly completed repair order information. Retailers may submit claims through [Subarunet.com](http://Subarunet.com).

Labor Description	Labor Operation #	Labor Time	Fail Code	Claim Type
TCM REPROGRAMMING, SSM DATA CHECK & VEHICLE INSPECTION WITH VIDEOSCOPE	A103-008	1	WRK-21	RC
TCM REPROGRAMMING, SSM DATA CHECK, TEST DRIVE & VEHICLE INSPECTION WITH VIDEOSCOPE	A103-018	1.3		
TCM REPROGRAMMING, SSM DATA CHECK & CVT ASSEMBLY REPLACEMENT	A103-000	5.3		
TCM REPROGRAMMING, SSM DATA CHECK, VEHICLE INSPECTION WITH VIDEOSCOPE & CVT ASSEMBLY REPLACEMENT	A103-010	5.5		
TCM REPROGRAMMING, SSM DATA CHECK, TEST DRIVE & CVT ASSEMBLY REPLACEMENT	A103-020	5.6		
TCM REPROGRAMMING, SSM DATA CHECK, VEHICLE INSPECTION WITH VIDEOSCOPE, TEST DRIVE & CVT ASSEMBLY REPLACEMENT	A103-030	5.8		

### IMPORTANT REMINDERS:

- SOA strongly discourages the printing and/or local storage of service information as previously released information and electronic publications may be updated at any time.
- Always check for any open recalls or campaigns anytime a vehicle is in for servicing.
- Always refer to STIS for the latest service information before performing any repairs.

# For Subaru Field Service Engineer Use ONLY

## Appendix A

**STEP 1:** Subaru of America, Inc. (SOA) highly recommends connecting either the Subaru Midtronics DCA-8000 Dynamic Diagnostic Charging System or the Subaru Midtronics GR8-100 Diagnostic Battery Charger to the vehicle and utilizing the Power Supply Mode feature to supply a stable **13.5 volts** anytime a vehicle control module is being reprogrammed.

Once the Midtronics charger is connected to the vehicle, **if the battery is fully charged**, it takes less than three (3) minutes to boot-up the charger, select the Power Supply Mode, and have the battery voltage stabilized and ready for reprogramming.

### NOTES:

- For instructions on using the power supply mode, reference the applicable User Manual for the Midtronics DCA-8000 Dynamic Diagnostic Charging System and the Midtronics GR8-1100 Diagnostic Battery Charger on STIS.
- Confirm all electrical loads such as lights, audio, HVAC, seat heaters, and rear defroster are all switched **OFF** before setting up the charger for Power Supply Mode.
- Select the correct battery type (Flooded, EFB, Gel, AGM or AGM Spiral).
- Input the CCA which matches the vehicle's battery. **NOTE:** OE and replacement batteries have different CCA ratings. Always confirm the battery's CCA rating before proceeding.
- If using a DCA-8000 Dynamic Diagnostic Charging System, set the power supply voltage to 13.5 volts.
- **DO NOT** connect the DST-i or SDI until the Power Supply mode function has completed its battery test mode and the Charging Voltage has dropped to and shows a steady 13.5 Volts on the display.
- Once Power Supply Mode reaches a steady **13.5 volts**, connect the DST-i or SDI to the OBD connector and proceed with initiating the normal FlashWrite reprogramming process.
- Amperage will fluctuate based upon the vehicle's demand for power. **NOTE:** If the voltage rises beyond 14V while programming is in process, the procedure will abort. This can indicate a need to test or charge the vehicle battery before any further attempt at programming is made.

### VERY IMPORTANT:

This information is applicable to the Subaru Midtronics DCA-8000 Dynamic Diagnostic Charging System and the Subaru Midtronics GR8-1100 Diagnostic Battery Charger **ONLY**. It does not apply to any other brand / type of "generic" battery charger whatsoever. **ONLY** the DCA-8000 and the GR8-1100 and their Power Supply Mode feature have been tested and approved by SOA.

**REMINDER:** If the DCA-8000 or GR8-1100 indicates the vehicle's battery must be charged, charge it fully using the DCA-8000 or GR8-1100 before proceeding to reprogram the vehicle using the Power Supply Mode.

### NOTES:

- Control module failures resulting from battery discharge during reprogramming are not a matter for warranty. Should any DTCs reset after the reprogramming update is performed, diagnose per the procedure outlined in the applicable Service Manual.



## For Subaru Field Service Engineer Use ONLY

- The **NEW** Calibration Identification number (CID) for any newly-installed programming (as confirmed from the actual control module **AFTER** installation) **MUST** be noted on the repair order as this information is required for claim submission.
- The pack file listings provided in this bulletin are the latest available at the time of publishing. Updates are often released thereafter without revision to the original bulletin. For this reason, it is critical to always have the latest version of Select Monitor software installed on your system. You can confirm if a later version is available by entering the CID listed in this bulletin into FlashWrite. If a newer CID is shown as available in FlashWrite, reprogram using that file.

**STEP 2:** Using the SSM4, clear the AT Learning Data using the following procedure:

- Start > Diagnosis > Vehicle Selection > Each System > Transmission > Work Support > Clear AT Learning Data.
- Click “YES” and when “Execute Clear AT Learning” is displayed, click “YES” again.
- Turn the ignition OFF, wait at LEAST 30 seconds then turn the ignition back ON. At this point, the AT Temp light will start blinking; 4 times in 2 seconds to signify the Clear AT Learning procedure has completed successfully. If the AT Temp light does not flash as described, repeat Step 2 again from the beginning.

**NOTE:** AT Learning Procedure is **ONLY** required with CVT replacement.