

ATTENTION:
 GENERAL MANAGER
 PARTS MANAGER
 CLAIMS PERSONNEL
 SERVICE MANAGER

IMPORTANT - All Service Personnel Should Read and Initial in the boxes provided, right.

© 2022 Subaru of America, Inc. All rights reserved.



QUALITY DRIVEN® SERVICE

PRODUCT CAMPAIGN BULLETIN

APPLICABILITY: 2019-20MY Ascent
 2020MY Legacy 2.4L (turbo models)
 2020MY Outback 2.4L (turbo models)

SUBJECT: CVT Chain Guide Breakage

NUMBER: WRK-21R
DATE: 07/05/22
REVISED: 07/13/22
NHTSA ID: 21V-955

INTRODUCTION:

Subaru of America, Inc. (Subaru) is initiating a new safety and emissions Recall for certain 2019 - 2020 model year Ascent vehicles, 2020 model year turbo Legacy vehicles, and 2020 model year turbo Outback vehicles in which the Continuously Variable Transmission (CVT) chain may slip and/or break.

DESCRIPTION OF THE DEFECT AND SAFETY RISK

Due to an improper program in the transmission control module (TCM), the CVT chain may slip, resulting in breakage of the chain guide. If the chain guide breaks, fragments of the guide could inhibit the shift select mechanism. If the vehicle continues operation with the drive chain slipping, over time the CVT drive chain could break.

If a drive chain breakage occurs while the vehicle is in motion, the vehicle may experience a loss of motive power, increasing the risk of a crash.

AFFECTED VEHICLES

The number of U.S. vehicles included in this recall is 198,255.

Model Year	Carline	Production Date Range
2019-2020	Ascent	February 22, 2018 - July 20, 2020
2020	Legacy (turbo models)	July 15, 2019 – August 13, 2020
2020	Outback (turbo models)	July 15, 2019 – August 13, 2020

Not all vehicles in the production date ranges listed above may be included in this recall. Coverage for all affected vehicles must be confirmed by using the Vehicle Coverage Inquiry function on subarunet.com.

The tools and reprogramming files are now available to perform this repair. Therefore, the status of this recall has been set to 'Open-Limited Parts Available' for all affected vehicles to allow for repairs to begin if they are presented for service prior to owner notification.

CAUTION: VEHICLE SERVICING PERFORMED BY UNTRAINED PERSONS COULD RESULT IN SERIOUS INJURY TO THOSE PERSONS OR TO OTHERS.

Subaru Service Bulletins are intended for use by professional technicians ONLY. They are written to inform those technicians of conditions that may occur in some vehicles, or to provide information that could assist in the proper servicing of the vehicle. Properly trained technicians have the equipment, tools, safety instructions, and know-how to do the job correctly and safely. If a condition is described, DO NOT assume that this Service Bulletin applies to your vehicle, or that your vehicle will have that condition.

Subaru of America, Inc. is ISO 14001 Compliant

ISO 14001 is the international standard for excellence in Environmental Management Systems. Please recycle or dispose of automotive products in a manner that is friendly to our environment and in accordance with all local, state and federal laws and regulations.

Continued...

Note: This recall replaces Subaru’s previous WUV-07 recall issued in January 2020 for certain 2019 model year Ascent vehicles. Any open WUV-07 coverage has been expired. Vehicles affected by the previous recall must return to complete the WRK-21 recall repair, even if the previous recall repair was completed.

DESCRIPTION OF THE REMEDY

Each retailer will receive one videoscope kit and holder required for the chain guide inspection, at no charge.

For all affected vehicles, Subaru retailers will reprogram the TCM. The historical TCM data will be analyzed for chain slip characteristics and the chain guide will be visually inspected. If the vehicle is confirmed to have experienced drive chain slip or if the chain guide is damaged, the transmission assembly will be replaced. All remedy repairs necessary will be completed at no cost to the customer.

OWNER NOTIFICATION

Subaru previously notified affected vehicle owners of this recall with an interim letter by first class mail on February 7, 2022.

Affected vehicle owners will be notified that the remedy is available by first class mail, in phases beginning in August. Details of the phased owner notification schedule will be provided in subsequent subarunet.com announcements. Therefore, please refer to the “Communications/Announcements” section on subarunet.com for that information.

Copies of the interim and final owner notification letters will be included at the end of this bulletin.

RETAILER RESPONSIBILITY:

Please be advised that it is a violation of Federal law for a dealer to deliver a new motor vehicle covered by a recall under a sale or lease until the defect is remedied. Therefore, any Authorized Subaru Retailer failing to perform the applicable service procedures to correct all affected vehicles in their inventory prior to the vehicle being placed in service may be subject to civil penalties of up to \$22,423 per violation (i.e., for each vehicle), as provided in 49 CFR §578.6 and will also be in breach of the Subaru Dealer Agreement.

Any vehicles listed in any recall/campaign that are in retailer stock must be:

- Immediately identified
- Tagged or otherwise marked to prevent their delivery or use prior to repair
- Repaired in accordance with the repair procedures outlined in the Product Campaign Bulletin

Retailers are to promptly perform the applicable service procedures to correct all affected vehicles in their inventory (used, demo & SSLP). Whenever a vehicle subject to this recall is taken into retailer inventory, necessary steps should be taken to ensure the recall correction has been made before selling or releasing the vehicle.

Continued...

PART INFORMATION:

REMINDER: Always order the most up-to-date replacement parts based on the specific VIN being repaired.

Model	Part Description	Part Number	Quantity
Ascent with CVTF Cooler	CVT Assembly	31000AK130	1
Ascent Without CVTF Cooler	CVT Assembly	31000AK140	1
Outback & Legacy	CVT Assembly	31000AK270	1
Outback & Legacy	CVT Assembly	31000AK280	1
ALL	Subaru Extra MT	SOA748V0100	As Needed
	GSKT-16.3X22X1.0 (Inspection Plug Gasket)	803916100	1
	Transmission Cooler Flush	SOA868V9255	As Needed

IMPORTANT NOTES:

- The CVT Assembly **31000AK130** MUST be ordered through PRIME.
- All parts highlighted in gray are placed on hold and restricted from Partseye. The PIC team will release the ordered parts when contacted and provided with a valid VIN and order number. Contact must be made within five business days of the order or it will be canceled.
- The inspection plug gasket **803916100** is required for the inspection process. If CVT replacement is required, this gasket is to be used for the front differential fill overflow plug.

One-Time Use Parts Kit Contents for CVT Replacement SOA635172		
Part Description	Part Number	Quantity
GASKET	803914060	4
GASKET A	44011AL000	2
SELF LOCKING NUT	902330011	4
GASKET-EXHAUST PIPE REAR	44022AA123	1
GASKET-AIR INTAKE DUCT	14497AA080	1
GASKET-INTER COOLER	21896AA130	1
GASKET-EXHAUST PIPE REAR	44011AG000	1
NUT	902170049	2
GASKET 18X24X1.0	803918060	1
NUT FLG M12	902380023	2

IMPORTANT NOTE: The One-Time Use Parts Kit (**SOA635172**) MUST Be ordered through PRIME. This kit is **ONLY** to be ordered in the event of CVT replacement. **Do not order the items listed above individually.**

CVTF				
Model	Transmission Fluid	Part Number	Quantity/Unit/Pack	Warranty Part #
Ascent	High Torque CVTF-LV	SOA748V0300	5 Gallon Pail	SOA635312

Continued...

REQUIRED TOOLS:

This procedure will require Specialty Tool Kit **SOA635170**. The information below provides details on the individual components supplied in the kit.

- **CRITICAL:** At this time, Videoscope Kit **PROVIDED BY SOA** is the **ONLY** scope that can be used for this inspection. **NO** other scopes are to be used for chain inspection. **All retailers have been provided ONE Videoscope at no charge. Additional Videoscopes can be purchased from online automotive equipment suppliers at the retailers expense.**

- The **OTC 16-3880X Videoscope:** This is the approved Videoscope kit that is to be used for chain guide inspections.

IMPORTANT: This Videoscope has a removable tip. It is suggested to add thread lock (e.g. “blue” Loctite or equivalent) to ensure the tip is not lost during inspection.



- **Holder 18361AA090:** This specialty plug is used in conjunction with the OTC 16-3880X Videoscope Kit. It sets the position of the scope’s camera to provide an optimum inspection of the chain guide affected area.



NOTE: Any replacement orders for the holder will require a release from the PIC team.

SD Card Information:

ALWAYS confirm the Micro SD card is securely seated within the camera slot. If the card is not secure, it will be indicated by a **RED circle/slash** icon located on the lower left corner of the screen.



Removal of the Micro SD card from the display unit is **NOT REQUIRED** to transfer the camera (photo) image(s). A USB cable is provided in the OTC scope kit to connect the display unit directly to a PC for direct image transfer. In rare cases, the Micro SD card may require added effort during installation. A plastic trim tool can be used to **CAREFULLY** apply pressure to the card during installation. A “click-type” noise can be heard when the card is engaged. Successful card installation is indicated by the icon located on the lower left corner of the screen (**NO RED circle/slash**).



Continued...

DATA REQUIREMENTS:

The table below outlines the information required to be retained by the retailer for all WRK-21 service, per SOA warranty policy.

The table also outlines the information required to be attached to the service claim in the event of CVT replacement.

No QMR will be required.

RETAIN	ATTACH
Retailer must RETAIN this information on ALL WRK-21-related repair orders. (see below) per SOA warranty policy, up to 2 years, for the purpose of future review.	Retailer must ATTACH to the CLAIM this information on all CVT replacement claims (see below).
<u>SSM Data</u> Files (PREFERRED), screen or photo of SSM screen showing mileage data, "Slip A mileage 1, Slip A mileage 2, and Slip A mileage 3" displayed on SSM4	<u>SSM Data</u> Files (PREFERRED), screen capture or photo of SSM screen showing mileage data, "Slip A mileage 1, Slip A mileage 2, and Slip A mileage 3" displayed on SSM4 (If the CVT is being replaced due to slip data readings)
Inspection Scope Image: Clear photo or screen shot of 3880X OTC (SOA635170) Inspection Scope image	Inspection Scope Image: Clear photo or screen shot of 3880X OTC Inspection Scope image (ONLY in a situation when no CVT chain slip is detected with SSM and the chain guide is found to be in the INCORRECT position during inspection)
Transmission Serial Number: Clear photo of both the old transmission serial number, and new transmission's serial number (if CVT is replaced)	Transmission Serial Number: Clear photo of both the new and replaced CVT's serial number
WRK-21 RO Notes must include repair order out (repair completion) mileage) of any prior CVT replacement(s)	Write in the Claim Comment Section: The mileage of the prior CVT replacement used as part of the judgement (where applicable)

EXAMPLES

Clear photos of the transmission serial number. Required for the unit currently in the vehicle and of the replacement (if CVT is replaced).

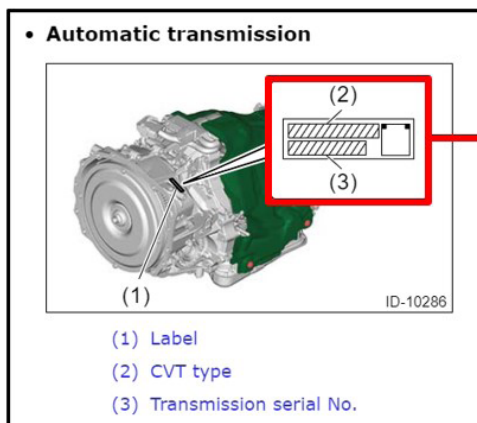

Continued...

A clear screenshot or photo of the “Slip A Information, Slip A mileage 1, Slip A Mileage 2, and Slip A Mileage 3” displayed on SSM.

Item	Value	Unit	Maximum	Minimum	Average
Slip A Information	1		1	1	1
Slip A Mileage 1	1250.0	mile	1250.0	1250.0	1250.0
Slip A Mileage 2	1875.0	mile	1875.0	1875.0	1875.0
Slip A Mileage 3	625.0	mile	625.0	625.0	625.0

ONLY in a situation when no CVT chain slip is detected with SSM and the chain guide is found to be in the incorrect position during inspection, a clear photo or screenshot of the scope image is required to be stored and noted along with the previously mentioned items 1 through 3.



Continued...

SERVICE PROCEDURE / INFORMATION:

IMPORTANT NOTE: If any concerns are reported with CVT operation, complete this recall **FIRST** and then proceed with related diagnosis if still needed. Reference TSBs 16-132-20R and 16-136-22R where appropriate.

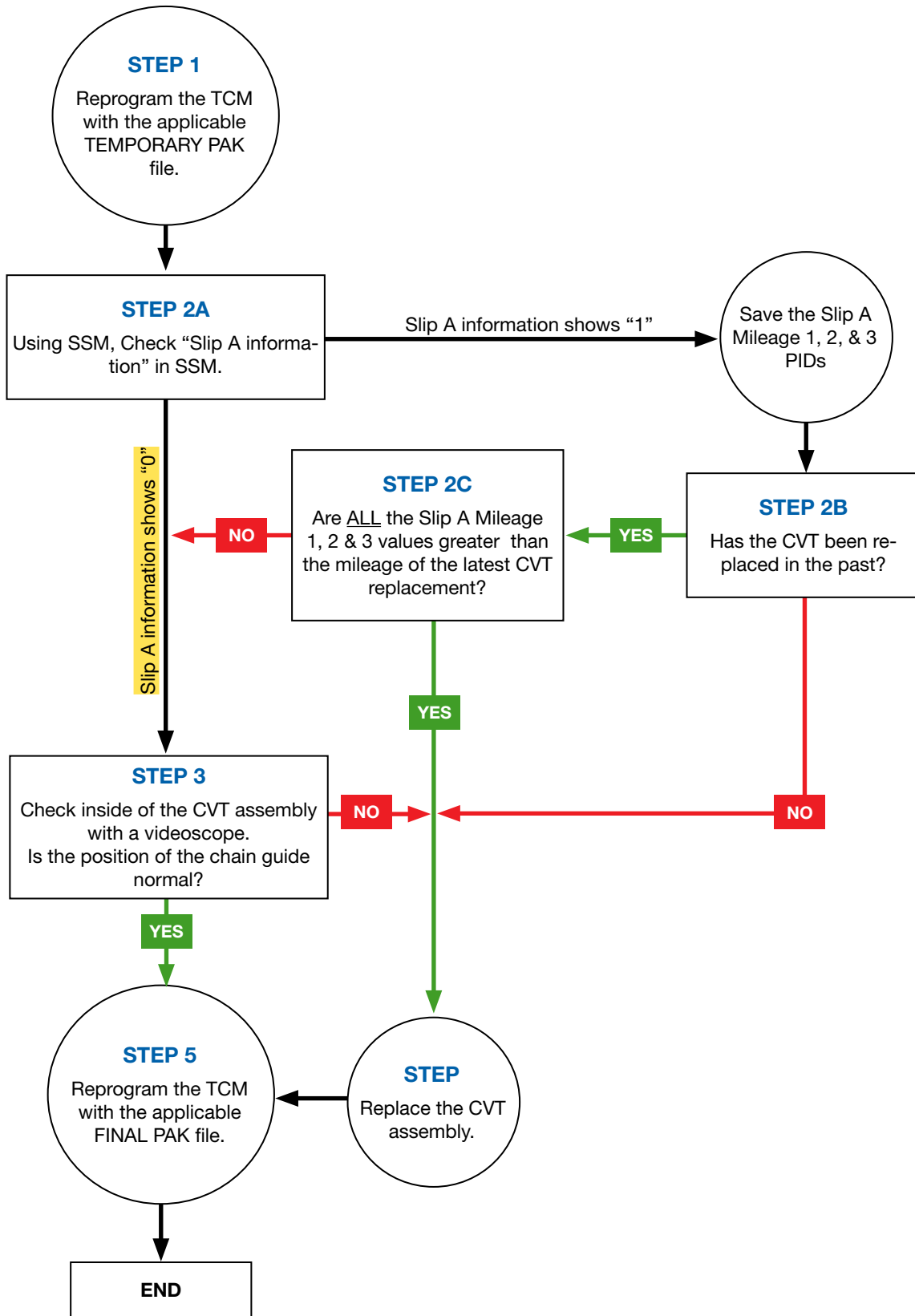

Continued...

STEP 1-A: Perform a DTC check of the TCM and confirm there are no current faults. Any previous faults must be diagnosed, repaired, and cleared prior to reprogramming. Reprogram the Transmission TCM with the **TEMPORARY** PAK file.

TEMPORARY PAK FILES							
Model	MY	Specification	PAK File Name	New ECM Part #	Old ECM Part #	Decryption Keyword	New CID Number
ASCENT	19	2.4L DIT CVT without CVTF cooler	QMBT-0141_ 30919AF98D.pak	30919AF98D	30919AF98A 30919AF98B 30919AF98C 30919AF98D	1A855E79	R8FEE800
		2.4L DIT CVT with CVTF cooler	QMBT-0141_ 30919AF99D.pak	30919AF99D	30919AF99A 30919AF99B 30919AF99C 30919AF99D	BF018535	R8FEF800
	20	2.4L DIT CVT without CVTF Air cooler	QMBT-0138_ 30919AH13E.pk2	30919AH13E	30919AH13A 30919AH13B 30919AH13C 30919AH13D 30919AH13E	2A8F4837	Q9FEE900
		2.4L DIT CVT with CVTF Air cooler	QMBT-0138_ 30919AH14E.pk2	30919AH14E	30919AH14A 30919AH14B 30919AH14C 30919AH14D 30919AH14E	43D63952	Q9FEF900
LEGACY	20	2.4L DIT CVT	QMBT-0138_ 30919AG75C.pk2	30919AG75C	30919AG75A 30919AG75B 30919AG75C	933736B4	C7FEC740
OUTBACK	20	2.4L DIT CVT	QMBT-0138_ 30919AG76C.pk2	30919AG76C	30919AG76A 30919AG76B 30919AG76C	CD3719E3	C7FEF740

NOTE: See **Appendix A** for additional information regarding control module reprogramming.

STEP 1-B: Display the following data using the Subaru Select Monitor (SSM4).

- Switch the ignition switch to the OFF position, **wait 30 seconds** then switch back to the ON position.
- **IMPORTANT:** Restart the SSM application after the **TEMPORARY** PAK file is installed.
- Verify the VIN information is correct and select “Diagnosis”.
- Select “Target Each System.”
- Select “Transmission” then select “Data Monitor”.

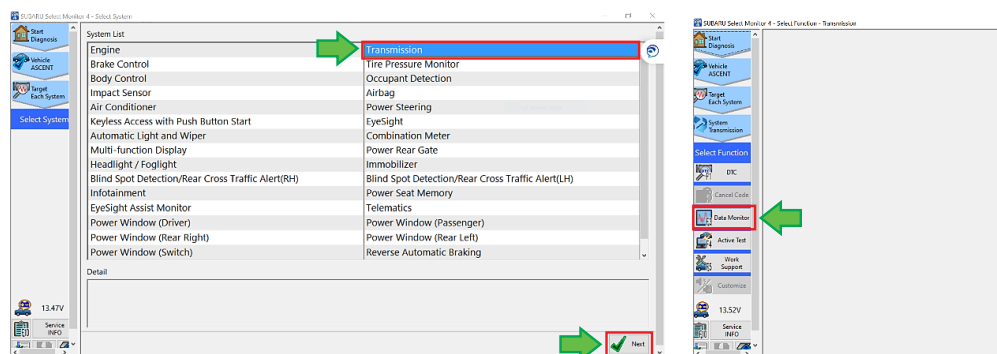

Continued...

- If required, click the “Delete All” button to move all items to the left side of the screen before making the selection. Scroll through the select signal list and confirm the “Slip A Information, Slip A Mileage 1, Slip A Mileage 2, and Slip A Mileage 3” items are selected (Blue Highlighted). Once the items are highlighted, click the “Add” button.

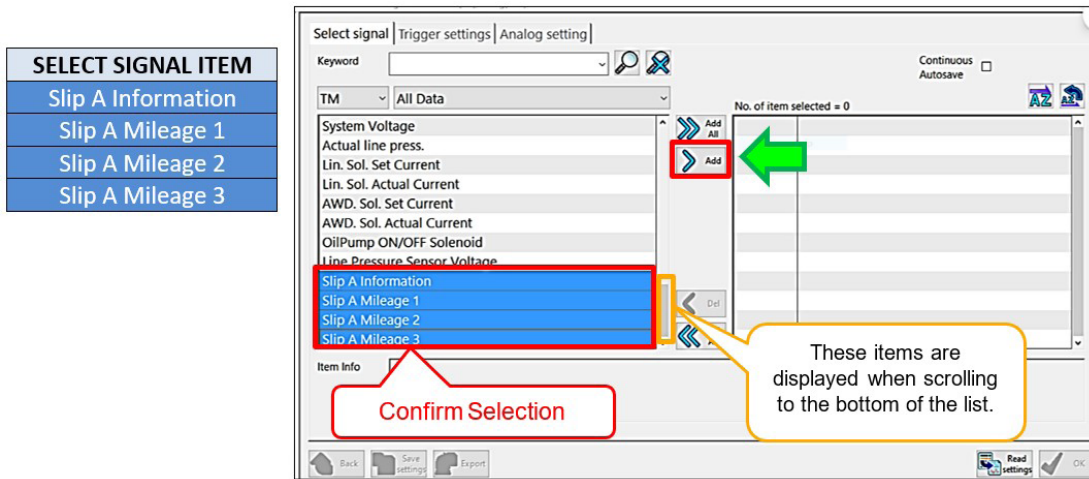

IMPORTANT: In the case of failed control module communication with SSM after the installation of the temporary PAK file, check and confirm the interface setting is matched to the equipment being used (SDI, DSTI, & DST 010).

- Confirm the selections are now transferred to the column on the right side. Continue by clicking the “OK” button.

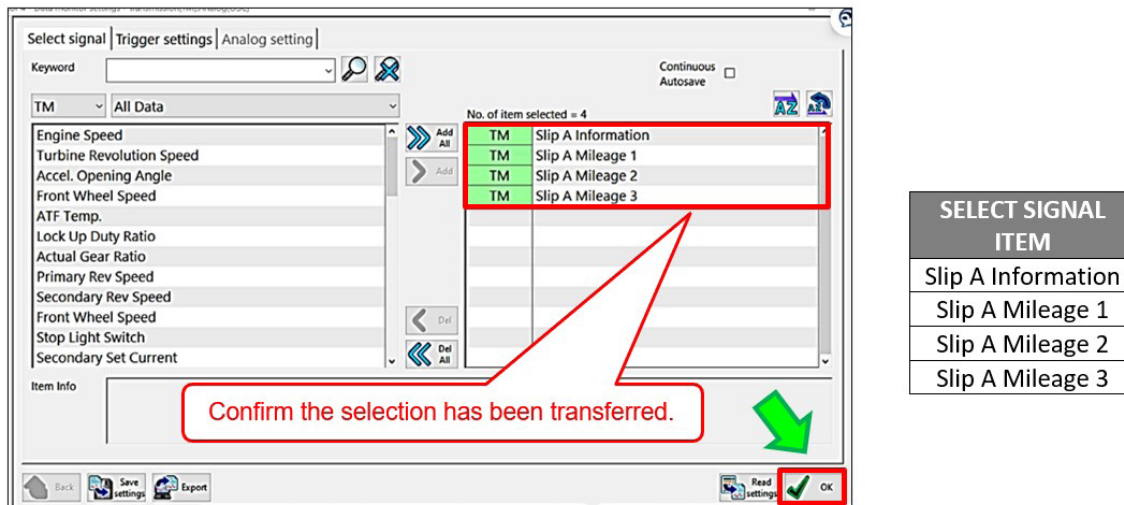

SELECT SIGNAL ITEM
Slip A Information
Slip A Mileage 1
Slip A Mileage 2
Slip A Mileage 3

STEP 2A: Determining the CVT chain slip data.

- If CVT chain slip has been detected, the “Slip A Information” will display a value higher than zero and the mileage will be recorded in any of the three mileage monitor (Maximum, Minimum, Average) items.

Item	Value	Unit	Maximum	Minimum	Average
Slip A Information	1		1	1	1
Slip A Mileage 1	1250.0	mile	1250.0	1250.0	1250.0
Slip A Mileage 2	1875.0	mile	1875.0	1875.0	1875.0
Slip A Mileage 3	625.0	mile	625.0	625.0	625.0

Continued...

- If CVT chain slip is NOT detected, there will be a zero in all four mileage monitor items.

Item	Value	Unit	Maximum	Minimum	Average
Slip A Information	0		0	0	0
Slip A Mileage 1	0.0	mile	0.0	0.0	0.0
Slip A Mileage 2	0.0	mile	0.0	0.0	0.0
Slip A Mileage 3	0.0	mile	0.0	0.0	0.0

- Review the “Slip A Information” value.

Select Signal Item	Value	Result	Next step
Slip A Information	0	CVT has no recorded slippage	Go to STEP 3
	1	Review the vehicle repair history	Go to STEP 2B

STEP 2B: Check the vehicle repair history and confirm if the vehicle has had any previous CVT replacements.

NOTE: For the best accuracy, always refer to the “out mileage” of the repair claim history.

Has the CVT assembly been previously replaced?

YES – Proceed to **STEP 2C**.

NO – Proceed to **STEP 4**.

STEP 2C: Compare the mileage of the latest CVT chain slip checked in STEP 2A with the mileage of the previous CVT assembly replacement.

NOTE: The Slip A Mileage values shown within the data will ALWAYS be in miles regardless of what unit is specified.

Item	Value	Unit	Maximum	Minimum	Average
Slip A Information	0		0	0	0
Slip A Mileage 1	0.0	mile	0.0	0.0	0.0
Slip A Mileage 2	0.0	mile	0.0	0.0	0.0
Slip A Mileage 3	0.0	mile	0.0	0.0	0.0

- If the values of “Slip A Mileage 1, 2, and 3” are **ALL** greater than the mileage of the last CVT replacement , proceed to **STEP 4**.
- If the values of “Slip A Mileage 1, 2, and 3” are **NOT ALL** greater than the mileage of the last CVT replacement, proceed to **STEP 3**.

STEP 3A: Disconnect the vehicle from the SSM. Remove the 10mm bolt retaining the insulator cover on the right side of the CVT.

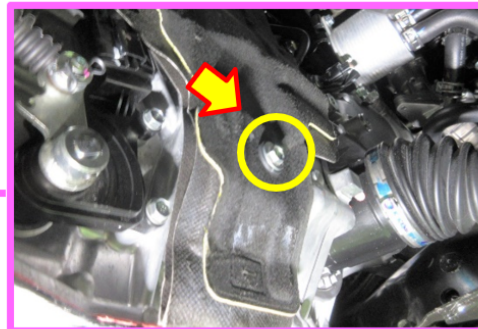
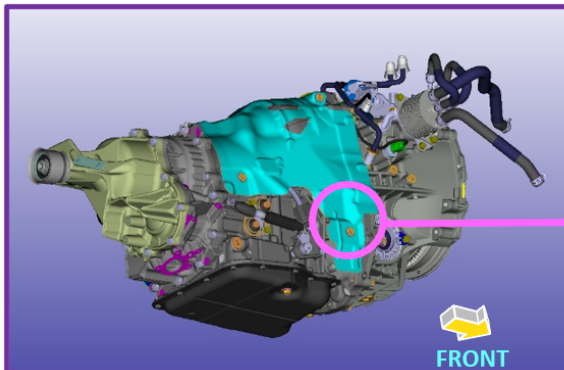

Continued...

STEP 3B: **CAREFULLY** lift the insulation **only as far as necessary** to expose the plug as shown below.

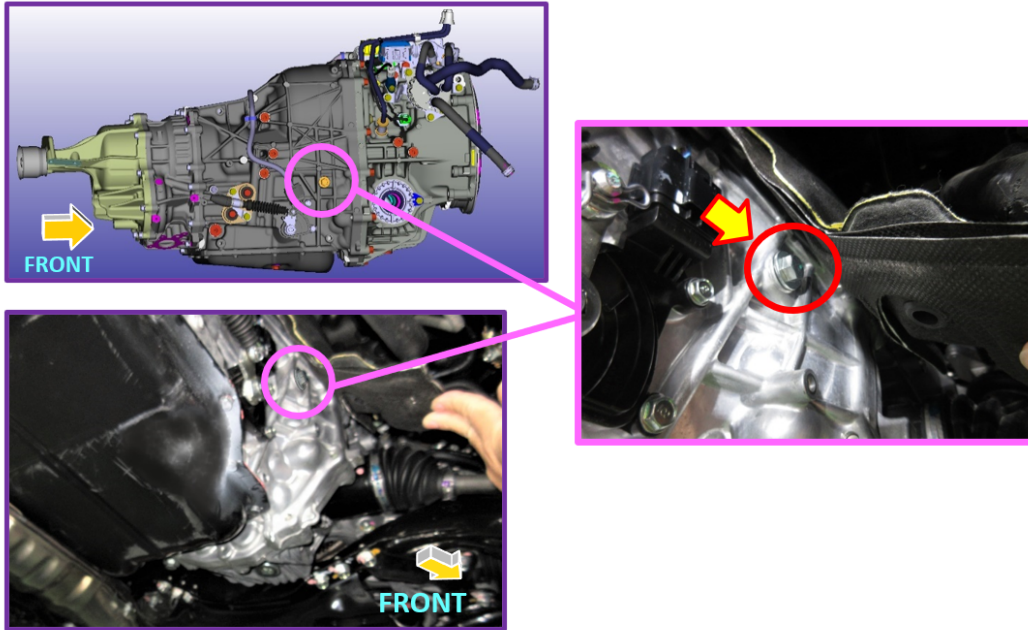

STEP 3C: Install and align the specialty plug / holder (**18361AA090**) as shown below.

- The holder is designed to provide the proper insertion angle for the videoscope camera.
- Install the tool by tightening the holder down **BY HAND ONLY**.
- Slightly loosen the holder so the flat section of the tool is facing downward (parallel to the floor). See the example illustrations below.

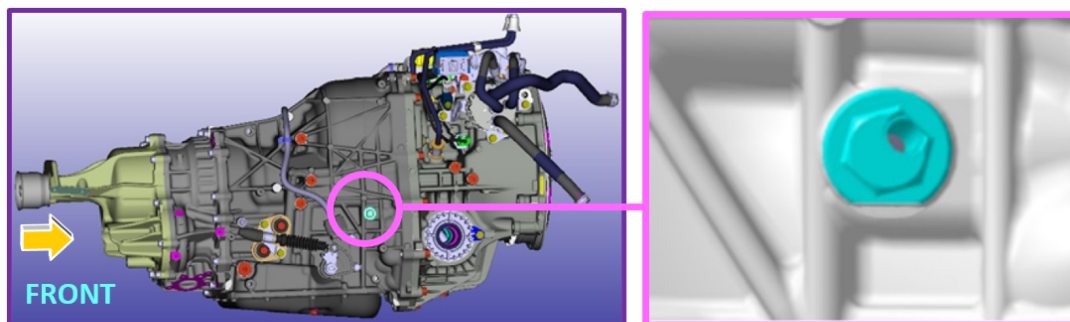

**Flat Section of the Holder
18361AA090**

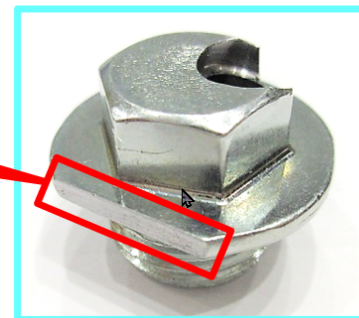

NOTE: **NEVER** use any wrench, socket, etc. when tightening the plug / holder tool. Teflon Tape can be applied to the holder threads for added stability.

Continued...

STEP 3D: Perform a visual inspection of the chain guide rail.

- Make sure the OTC videoscope's threaded camera tip is screwed on tight prior to usage. Prepare the videoscope camera by measuring and marking approximately 5mm (0.2inch) from where the metal section of the scope tip meets the flexible portion. This section can be marked using a marker or tape. Use the example photos below as a guide.

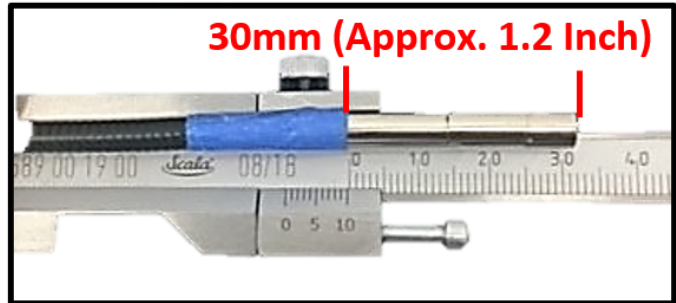
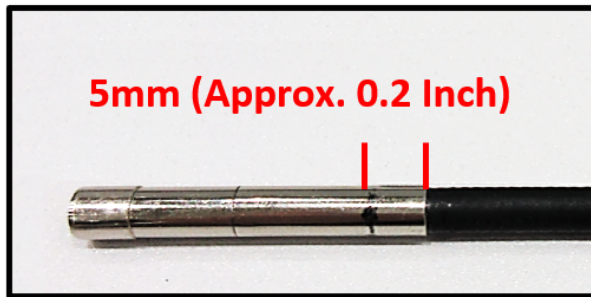

- Identify the top section of the scope camera lens while performing a function test of the videoscope. This can help for the scope view positioning.
- Insert the videoscope camera into the plug / holder up to the previously marked line

CRITICAL: To prevent any unwanted damage to the videoscope tip, ALWAYS use caution when inserting and removing the videoscope camera into the holder.

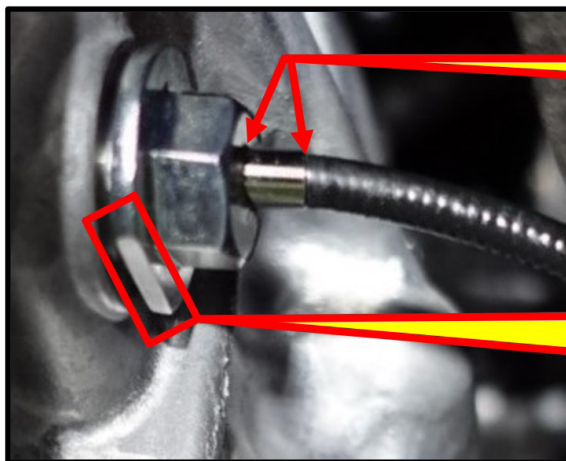

5mm (Approx. 0.2 inch)

Maintain the "Parallel to the Floor" Position of the Plug / Holder Tool

- Set the magnification of the videoscope to 1.0.

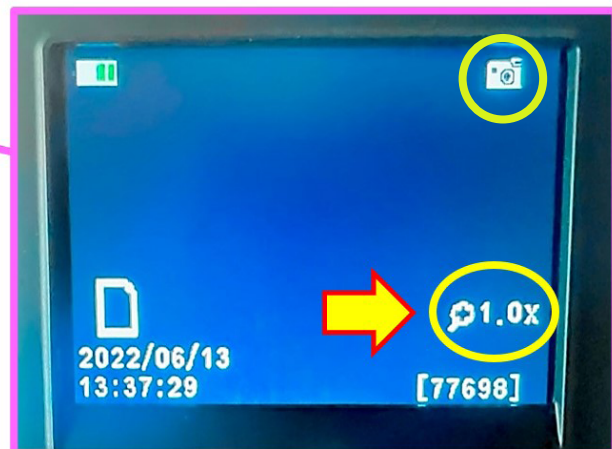

Continued...

STEP 3E: Inspect the position of the lower end of the chain guide rail and the drive pinion shaft.

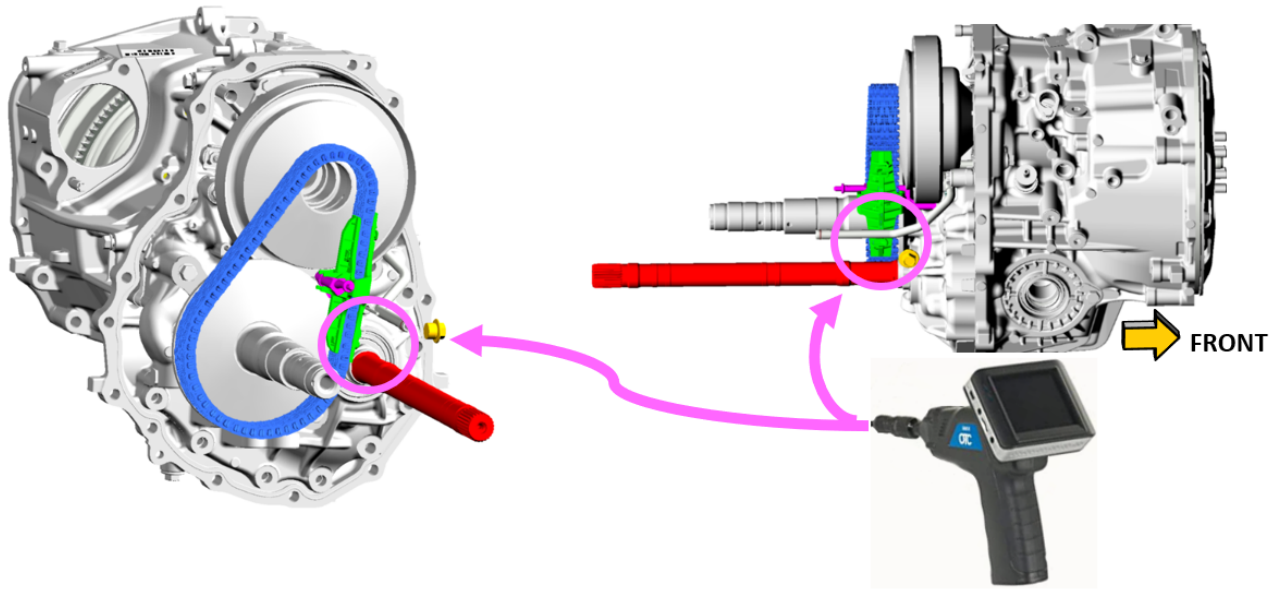

CORRECT GUIDE POSITIONING:

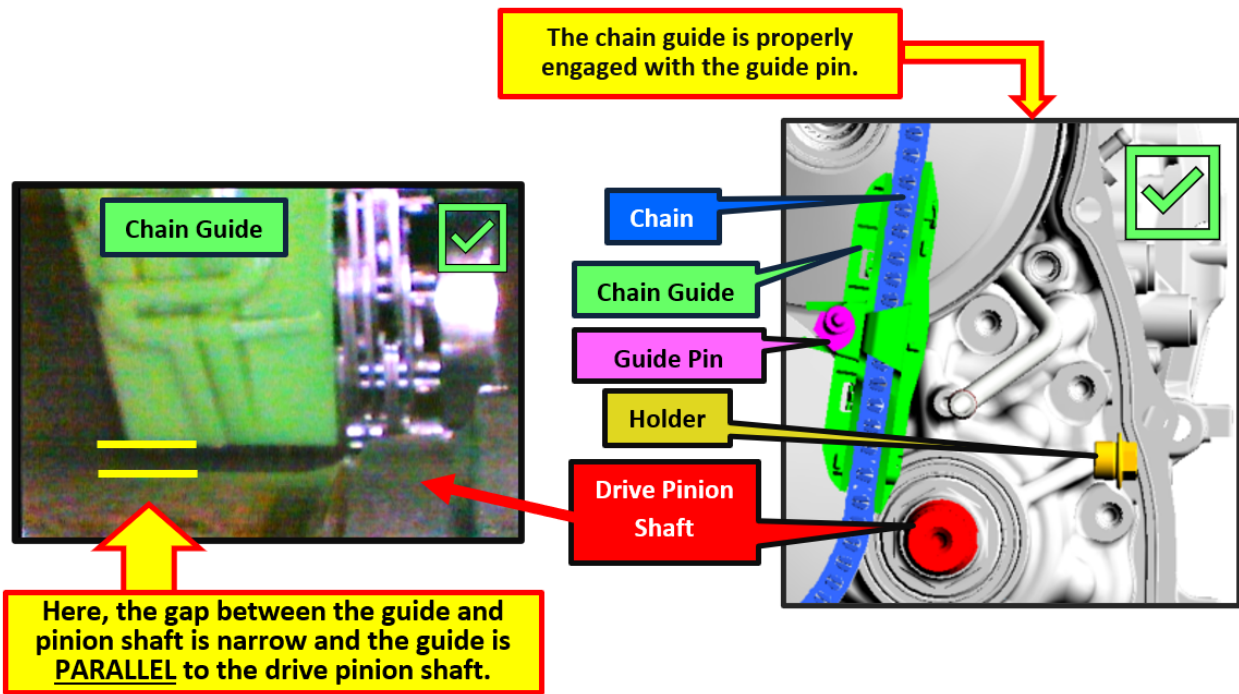

Continued...

INCORRECT GUIDE POSITIONING 1:

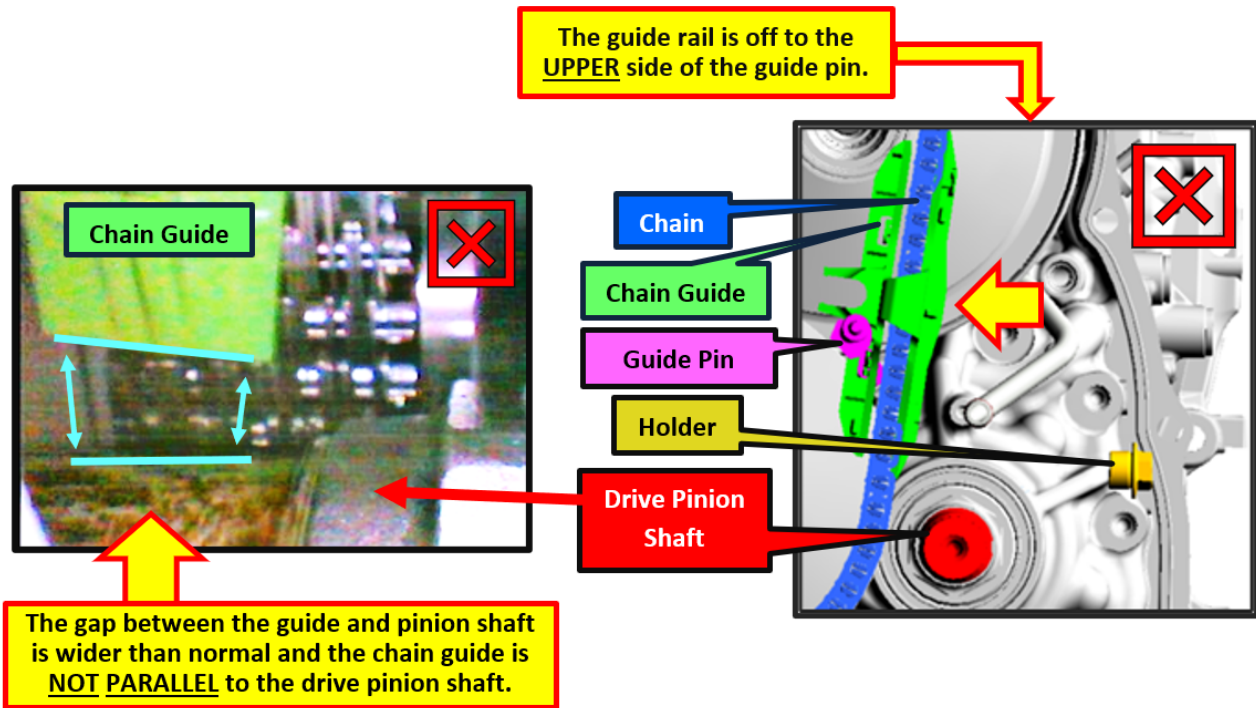

INCORRECT GUIDE POSITIONING 2:

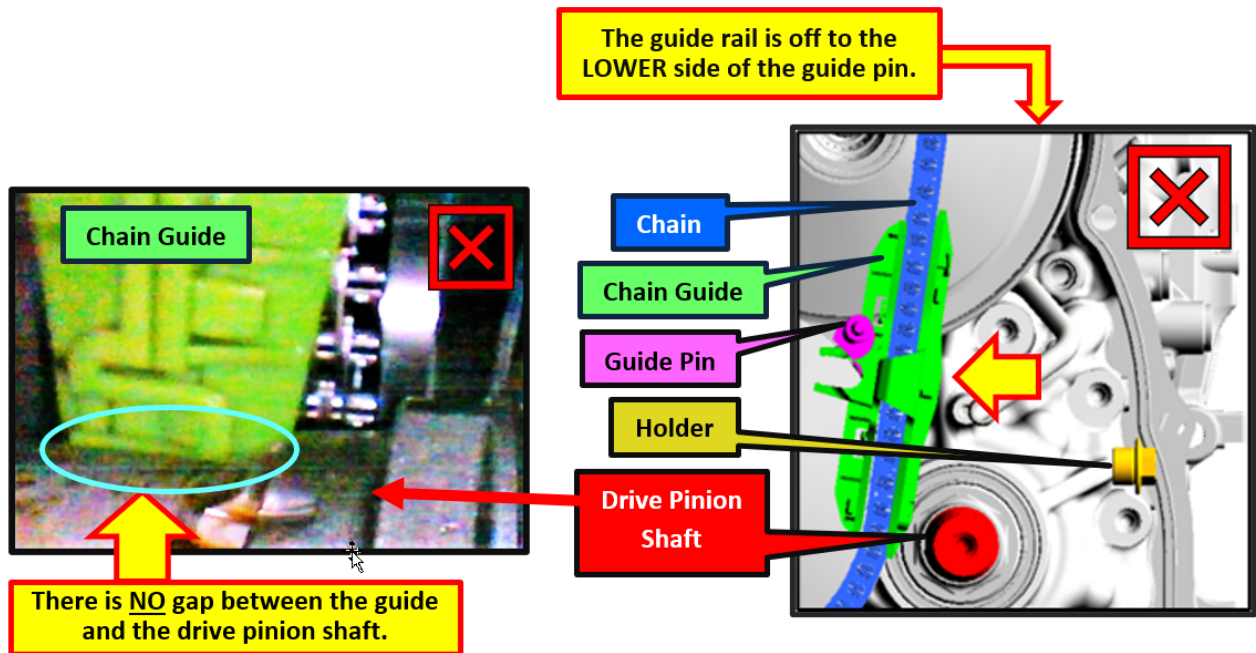

Continued...

STEP 3F: Remove the holder (18361AA090).

- Reinstall the original plug **with a NEW gasket.**
Tightening torque: 35 N·m (25.8ft-lbs.)
- Install the bolt retaining the insulator cover.
Tightening torque: 8 N·m (5.9ft-lbs.)

STEP 3G: Using the inspection results from **STEP 3E**, see the table below to determine the next course of action.

Result	Next step
CORRECT POSITION	Proceed to STEP 5
INCORRECT POSITION 1 OR 2	Proceed to STEP 4A

STEP 4A: Replace the CVT assembly.

The service procedures for CVT assembly replacement remain unchanged. Always refer to the applicable Service Manual and review the full requirements of the repair being performed. The Service Manual procedures contain information critical to performing an effective repair the first time, every time. This includes but is not limited to important SAFETY precautions, proper inspection criteria, necessary special tools, required processes and related one-time-use parts needed for a complete and lasting repair.

Refer to STIS: Transmission/Transaxle > CONTINUOUSLY VARIABLE TRANSMISSION > Transmission Assembly > Removal/Installation

IMPORTANT NOTE: When replacing the CVT assembly, **ALWAYS** perform a transmission cooler flush as per the Claims Policies and Procedures Manual using **SOA868V9255**.

STEP 4B: Proceed to **STEP 5**.

STEP 5: Reprogram the TCM with the applicable PAK file. When reprogramming is complete, confirm there are no faults stored in the TCM.

WRK-21 FINAL PAK FILES							
Model	MY	Specification	PAK file name	New ECU Part #	Old ECU Part #	Decryption Keyword	New CID Number
ASCENT	19	2.4L DIT CVT without CVTF cooler	30919AF98E.pak	30919AF98E	30919AF98D	347BBBA5	R8FEE900
		2.4L DIT CVT with CVTF cooler	30919AF99E.pak	30919AF99E	30919AF99D	AF4E5A81	R8FEF900
	20	2.4L DIT CVT without CVTF Air cooler	30919AH13F.pk2	30919AH13F	30919AH13E	68297EB0	Q9FEEA00
		2.4L DIT CVT with CVTF Air cooler	30919AH14F.pk2	30919AH14F	30919AH14E	935CAE53	Q9FEFA00
LEGACY	20	2.4L DIT CVT	30919AG75D.pk2	30919AG75D	30919AG76C	F7DE7793	C7FEC840
OUTBACK	20	2.4L DIT CVT	30919AG76D.pk2	30919AG76D	30919AG75C	C084BD9F	C7FEF840

Continued...

NOTE: See **Appendix A** for additional information regarding control module reprogramming.

CAUTION: Confirm the ATF oil temp warning light stays off after all reprogramming has been performed.

CALIFORNIA “VEHICLE EMISSION RECALL - PROOF OF CORRECTION” CERTIFICATE

The California Air Resources Board and the Department of Motor Vehicles Registration/Recall Program requires that all emission related Recall/Campaign or Service Program repairs be completed before a vehicle registration is renewed. Please provide owners of vehicles registered in the state of California a completed “Vehicle Emission Recall - Proof of Correction” certificate. Vehicle owners should be advised to retain this certificate because the California Department of Motor Vehicles may require they provide proof this service program repair has been completed. Additional certificates are available through normal parts ordering channels using part number MSA6P1301. Quantity 1 = 1 booklet of 50 certificates.

SERVICE PROGRAM IDENTIFICATION LABEL:

Type or print the necessary information on a Campaign Identification Label. The completed label should be attached to the vehicle’s upper radiator support. Additional labels are available through normal parts ordering channels. The part number is **MSA6P1302**, which comes as one sheet of 20 labels.

Part Number	Applicability	Description	Order Quantity
MSA6P1302	All Models	Campaign Completion Labels (contains one sheet of 20 labels)	1

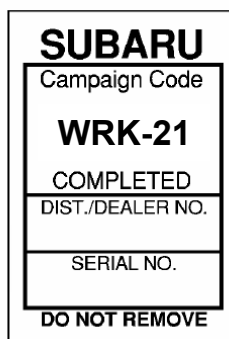

Continued...

CLAIM REIMBURSEMENT AND ENTRY PROCEDURES:

Credit to perform this recall will be based on properly completed repair order information. Retailers may submit claims through Subarunet.com.

IMPORTANT: The Calibration Identification number (CID) for the **FINAL** programming (not the testing file) **MUST** be noted on the repair order as this information is required for claim submission.

Labor Description	Labor Operation #	Labor Time	Fail Code	Claim Type
TCM REPROGRAMMING, SSM DATA CHECK & VEHICLE INSPECTION WITH VIDEOSCOPE	A103-008	1.0	WRK-21	RC
TCM REPROGRAMMING, SSM DATA CHECK & CVT ASSEMBLY REPLACEMENT/ CVTF COOLER FLUSH AND PERFORM AT LEARNING PROCEDURE*	A103-000	5.3		
TCM REPROGRAMMING, SSM DATA CHECK, VEHICLE INSPECTION WITH VIDEOSCOPE & CVT ASSEMBLY REPLACEMENT/ CVTF COOLER FLUSH AND PERFORM AT LEARNING PROCEDURE*	A103-010	5.5		

*Operations include time for necessary CVTF Cooler flushing. Please refer to 16-42-90R for further information.

IMPORTANT REMINDERS:

- SOA strongly discourages the printing and/or local storage of service information as previously released information and electronic publications may be updated at any time.
- Always check for any open recalls or campaigns anytime a vehicle is in for servicing.
- Always refer to STIS for the latest service information before performing any repairs.

Continued...

Appendix A

STEP A-1: Subaru of America, Inc. (SOA) highly recommends connecting either the Subaru Midtronics DCA-8000 Dynamic Diagnostic Charging System or the Subaru Midtronics GR8-100 Diagnostic Battery Charger to the vehicle and utilizing the Power Supply Mode feature to supply a stable 13.5 volts anytime a vehicle control module is being reprogrammed.

Once the Midtronics charger is connected to the vehicle, **if the battery is fully charged**, it takes less than three (3) minutes to boot-up the charger, select the Power Supply Mode, and have the battery voltage stabilized and ready for reprogramming.

NOTES:

- For instructions on using the power supply mode, reference the applicable User Manual for the Midtronics DCA-8000 Dynamic Diagnostic Charging System and the Midtronics GR8-1100 Diagnostic Battery Charger on STIS.
- Confirm all electrical loads such as lights, audio, HVAC, seat heaters, and rear defroster are all switched **OFF** before setting up the charger for Power Supply Mode.
- Select the correct battery type (Flooded, EFB, Gel, AGM, or AGM Spiral).
- Input the CCA which matches the vehicle's battery. **NOTE:** OE and replacement batteries have different CCA ratings. Always confirm the battery's CCA rating before proceeding.
- If using a DCA-8000 Dynamic Diagnostic Charging System, set the power supply voltage to 13.5 volts.
- **DO NOT** connect the DST-I, DST 010, or SDI until the Power Supply mode function has completed its battery test mode and the Charging Voltage has dropped to and shows a steady 13.5 Volts on the display.
- Once Power Supply Mode reaches a steady **13.5 volts**, connect the DST-I, DST 010, or SDI to the OBD connector and proceed with initiating the normal FlashWrite reprogramming process.
- Amperage will fluctuate based upon the vehicle's demand for power. **NOTE:** If the voltage rises beyond 14V while programming is in process, the procedure will abort. This can indicate a need to test or charge the vehicle battery before any further attempt at programming is made.

VERY IMPORTANT:

This information is applicable to the Subaru Midtronics DCA-8000 Dynamic Diagnostic Charging System and the Subaru Midtronics GR8-1100 Diagnostic Battery Charger **ONLY**. It does not apply to any other brand / type of "generic" battery charger whatsoever. **ONLY** the DCA-8000 and the GR8-1100 and their Power Supply Mode feature have been tested and approved by SOA.

REMINDER: If the DCA-8000 or GR8-1100 indicates the vehicle's battery must be charged, charge it fully using the DCA-8000 or GR8-1100 before proceeding to reprogram the vehicle using the Power Supply Mode.

Continued...

NOTES:

- Control module failures resulting from battery discharge during reprogramming are not a matter for warranty. Should any DTCs reset after the reprogramming update is performed, diagnose per the procedure outlined in the applicable Service Manual.
- **IMPORTANT:** The **FINAL** Calibration Identification number (CID) for the **FINAL** programming (not the testing file) **MUST** be noted on the repair order as this information is required for claim submission.
- The testing and FINAL pack file listings provided in this bulletin are the latest available at the time of publishing. Updates are often released thereafter without revision to the original bulletin. For this reason, it is critical to always have the latest version of Select Monitor software installed on your system. You can confirm if a later version is available by entering the CID listed in this bulletin into FlashWrite. If a newer CID is shown as available in FlashWrite, reprogram using that file.
- AT Learning Procedure is **ONLY** required with CVT replacement.

STEP A-2: (ONLY IF THE CVT HAS BEEN REPLACED) Using the SSM4, clear the AT Learning Data using the following procedure:

- Start > Diagnosis > Vehicle Selection > Each System > Transmission > Work Support > Clear AT Learning Data.
- Click “YES” and when “Execute Clear AT Learning” is displayed, click “YES” again.
- Turn the ignition OFF, **wait at LEAST 30 seconds** then turn the ignition back ON. At this point, the AT Temp light will start blinking; 4 times in 2 seconds to signify the Clear AT Learning procedure has completed successfully. If the AT Temp light does not flash as described, repeat **Step 2** again from the beginning.

Continued...

URGENT
IMPORTANT SAFETY RECALL
This notice applies to the VIN below



SUBARU

Subaru of America, Inc
PO Box 9103
Camden, NJ 08101-9877
844-373-6614
www.subaru.com

Subaru Safety Recall WRK-21
NHTSA Recall ID 21V-955
February 2022
Interim Notification

Dear Subaru Owner:

This notice is sent to you in accordance with the National Traffic and Motor Vehicle Safety Act.

Subaru of America, Inc. (Subaru) has decided that a defect, which relates to motor vehicle safety, exists in certain 2019-2020 model year Ascent vehicles and certain 2020 Legacy and Outback vehicles.

You received this notice because our records indicate that you currently own one of these vehicles.

DESCRIPTION OF THE DEFECT AND SAFETY RISK

Due to a programming error in the transmission control unit (TCU), the drive chain may slip, resulting in breakage of the chain guide. If the drive chain guide breaks, resulting fragments could inhibit the shift select mechanism. If the vehicle continues operation with the drive chain slipping, over time the drive chain could break.

If the drive chain breaks while the vehicle is in motion, the vehicle may experience a loss of motive power, increasing the risk of a crash.

WHAT YOU SHOULD DO

Subaru is in the process of acquiring the tools and reprogramming files necessary to perform this repair and expects to have a sufficient supply available in May. Once the repair is available, Subaru will contact you again by mail advising you to proceed with scheduling an appointment with your Subaru retailer (dealer).

WHAT SUBARU WILL DO

Once the tools and reprogramming files are available to perform this repair, your Subaru retailer will reprogram the TCU. The historical TCU data will be analyzed for chain slip characteristics and the chain guide will be visually inspected. If the vehicle is confirmed to have experienced drive chain slip or if the chain guide is damaged, the transmission assembly will be replaced. All remedy repairs necessary will be completed at no cost to you.

OWNER INFORMATION

Government regulations require that recall notifications be sent to the last known owner of record. That information is based primarily on state registration and title data. If you are a lessor of this vehicle, federal regulations require you to forward this notice to your lessee within ten days.

If you have moved or sold your vehicle, please update this information online at www.subaru.com, select 'Customer Support,' then select 'Address Update' or 'Ownership Update' from the "Quick Links" menu.

IF YOU HAVE PREVIOUSLY PAID FOR A REPAIR

If you have already paid for repairs associated with this condition, you may be eligible for reimbursement. Reimbursement consideration will be based on the amount an authorized Subaru retailer in your area would charge for the same repair.

Please send the original service repair order, which has the name of the repair facility, date of repair, mileage at the time of repair, complete 17-digit vehicle identification number (VIN), and your name, with correct mailing address and telephone number to the address listed below.

Subaru of America, Inc.
Customer-Retailer Services Department, Attention: WRK-21 Recall
P.O. Box 9103, Camden, NJ 08101-9877

Please send original receipts only and retain a photocopy for your records. Please be assured that we will attempt to process your reimbursement request as quickly as possible, but it may take up to 60 days for this process to be completed.

IF YOU NEED FURTHER ASSISTANCE:

To locate the nearest Subaru retailer, you can access our website at www.subaru.com and select 'Find a Retailer.'

For additional information, please go to: <http://www.wrk21.service-campaign.com>.

If you need additional assistance, please contact us directly:

- By e-mail: Go to www.subaru.com and select "Customer Support"
- By telephone: 1-844-373-6614
Monday through Friday between 8:00 a.m. and 7:00 p.m. ET
- By U.S. Postal mail: Write us at Subaru of America, Inc.
Attn: Customer-Retailer Services Department
P.O. Box 9103, Camden, NJ 08101-9877

To subscribe to the NHTSA Recall Notification email System, please go to: <https://www-odi.nhtsa.dot.gov/nhtsa/subscriptions>.

Please contact us immediately if the Subaru retailer fails or is unable to make the necessary repairs free of charge.

Continued...

You may also contact the Administrator, National Highway Traffic Safety Administration (NHTSA), 1200 New Jersey Ave., SE, Washington, DC 20590 or call the toll-free Vehicle Safety Hotline at 1-888-327-4236 (TTY: 1-800-424-9153) or go to <http://www.safercar.gov> if you believe the Subaru retailer has failed or is unable to remedy your vehicle without charge within a reasonable amount of time.

Your continued satisfaction with your Subaru is important to us. Please understand that we have taken this action in the interest of your safety and your vehicle's proper operation. We sincerely apologize for any inconvenience this matter may cause and urge you to schedule an appointment once you are notified that the remedy is available.

Sincerely,

Subaru of America, Inc.

A subsidiary of SUBARU CORPORATION

Continued...

URGENT
IMPORTANT SAFETY RECALL
This notice applies to the VIN below



SUBARU

Subaru of America, Inc
PO Box 9103
Camden, NJ 08101-9877
844-373-6614
www.subaru.com

Subaru Safety Recall WRK-21
NHTSA Recall ID 21V-955
February 2022
Interim Notification

Dear Subaru Owner:

This notice is sent to you in accordance with the National Traffic and Motor Vehicle Safety Act.

Subaru of America, Inc. (Subaru) has decided that a defect, which relates to motor vehicle safety, exists in certain 2019-2020 model year Ascent vehicles and certain 2020 Legacy and Outback vehicles.

You received this notice because our records indicate that you currently own one of these vehicles.

This recall replaces Subaru's previous WUV-07 recall issued in January 2020 for certain 2019 model year Ascent vehicles. Vehicles affected by the previous recall must return to complete the WRK-21 recall repair, even if the previous recall repair was complete.

DESCRIPTION OF THE DEFECT AND SAFETY RISK

Due to a programming error in the transmission control unit (TCU), the drive chain may slip, resulting in breakage of the chain guide. If the drive chain guide breaks, resulting fragments could inhibit the shift select mechanism. If the vehicle continues operation with the drive chain slipping, over time the drive chain could break.

If the drive chain breaks while the vehicle is in motion, the vehicle may experience a loss of motive power, increasing the risk of a crash.

WHAT YOU SHOULD DO

As mentioned above, vehicles affected by the previous recall must return to complete the WRK-21 recall repair, even if the previous recall repair was completed.

Subaru is in the process of acquiring the tools and reprogramming files necessary to perform this repair and expects to have a sufficient supply available in May. Once the repair is available, Subaru will contact you again by mail advising you to proceed with scheduling an appointment with your Subaru retailer (dealer).

WHAT SUBARU WILL DO

Once the tools and reprogramming files are available to perform this repair, your Subaru retailer will reprogram the TCU. The historical TCU data will be analyzed for chain slip characteristics and the chain guide will be visually inspected. If the vehicle is confirmed to have experienced drive chain slip or if the chain guide is damaged, the transmission assembly will be replaced. All remedy repairs necessary will be completed at no cost to you.

Continued...

OWNER INFORMATION

Government regulations require that recall notifications be sent to the last known owner of record. That information is based primarily on state registration and title data. If you are a lessor of this vehicle, federal regulations require you to forward this notice to your lessee within ten days.

If you have moved or sold your vehicle, please update this information online at www.subaru.com, select 'Customer Support,' then select 'Address Update' or 'Ownership Update' from the "Quick Links" menu.

IF YOU HAVE PREVIOUSLY PAID FOR A REPAIR

If you have already paid for repairs associated with this condition, you may be eligible for reimbursement. Reimbursement consideration will be based on the amount an authorized Subaru retailer in your area would charge for the same repair.

Please send the original service repair order, which has the name of the repair facility, date of repair, mileage at the time of repair, complete 17-digit vehicle identification number (VIN), and your name, with correct mailing address and telephone number to the address listed below.

Subaru of America, Inc.
Customer-Retailer Services Department, Attention: WRK-21 Recall
P.O. Box 9103, Camden, NJ 08101-9877

Please send original receipts only and retain a photocopy for your records. Please be assured that we will attempt to process your reimbursement request as quickly as possible, but it may take up to 60 days for this process to be completed.

IF YOU NEED FURTHER ASSISTANCE:

To locate the nearest Subaru retailer, you can access our website at www.subaru.com and select 'Find a Retailer.'

For additional information, please go to: <http://www.wrk21.service-campaign.com>.

If you need additional assistance, please contact us directly:

- By e-mail: Go to www.subaru.com and select "Customer Support"
- By telephone: 1-844-373-6614
Monday through Friday between 8:00 a.m. and 7:00 p.m. ET
- By U.S. Postal mail: Write us at Subaru of America, Inc.
Attn: Customer-Retailer Services Department
P.O. Box 9103, Camden, NJ 08101-9877

To subscribe to the NHTSA Recall Notification email System, please go to: <https://www-odi.nhtsa.dot.gov/nhtsa/subscriptions>.

Please contact us immediately if the Subaru retailer fails or is unable to make the necessary repairs free of charge.

Continued...

You may also contact the Administrator, National Highway Traffic Safety Administration (NHTSA), 1200 New Jersey Ave., SE, Washington, DC 20590 or call the toll-free Vehicle Safety Hotline at 1-888-327-4236 (TTY: 1-800-424-9153) or go to <http://www.safercar.gov> if you believe the Subaru retailer has failed or is unable to remedy your vehicle without charge within a reasonable amount of time.

Your continued satisfaction with your Subaru is important to us. Please understand that we have taken this action in the interest of your safety and your vehicle's proper operation. We sincerely apologize for any inconvenience this matter may cause and urge you to schedule an appointment once you are notified that the remedy is available.

Sincerely,

Subaru of America, Inc.

A subsidiary of SUBARU CORPORATION