

Safety Recall

Code: 90S9



REVISION

Subject	Gateway Control Module																									
Release Date	March 23, 2022																									
REVISION SUMMARY	Updated requirements for contacting Audi Warranty in the event a gateway control module is damaged																									
Affected Vehicles	<table border="1"><thead><tr><th>Country</th><th>Beginning Model Year</th><th>Ending Model Year</th><th>Vehicle</th><th>Vehicle Count</th></tr></thead><tbody><tr><td>USA</td><td>2018</td><td>2022</td><td>Q5</td><td>251,971</td></tr><tr><td>USA</td><td>2018</td><td>2022</td><td>SQ5</td><td>37,020</td></tr><tr><td>CAN</td><td>2018</td><td>2022</td><td>Q5</td><td>41,214</td></tr><tr><td>CAN</td><td>2018</td><td>2022</td><td>SQ5</td><td>6,932</td></tr></tbody></table> <p>Check Campaigns/Actions screen in Elsa on the day of repair to verify that a VIN qualifies for repair under this action. Elsa is the <u>only</u> valid campaign inquiry & verification source.</p> <ul style="list-style-type: none">✓ Campaign status must show "open."✓ If Elsa shows other open action(s), inform your customer so that the work can also be completed at the same time the vehicle is in the workshop for this campaign.	Country	Beginning Model Year	Ending Model Year	Vehicle	Vehicle Count	USA	2018	2022	Q5	251,971	USA	2018	2022	SQ5	37,020	CAN	2018	2022	Q5	41,214	CAN	2018	2022	SQ5	6,932
Country	Beginning Model Year	Ending Model Year	Vehicle	Vehicle Count																						
USA	2018	2022	Q5	251,971																						
USA	2018	2022	SQ5	37,020																						
CAN	2018	2022	Q5	41,214																						
CAN	2018	2022	SQ5	6,932																						
Problem Description	<p>If liquid reaches and enters the gateway control module, mostly due to a liquid spill on the rear seats, it is being switched off as part of the safety concept. In very rare cases (such as when driving through heavy rain or deep water) there may also be water ingress through an insufficient underbody seam. Water/liquid ingress into the gateway control module may lead to various internal errors due to short circuits within the control unit.</p> <p>The gateway control module has a safety concept in case implausible signals are detected in the control unit. If such implausible signals are detected, the gateway switches off its function in order to avoid unwanted vehicle reactions. The vehicle remains steerable and the brake system is fully operable. The engine goes into emergency mode and remains in operation with reduced power.</p> <p>Unexpected reduced engine power may create an increased risk of a crash in certain driving situations.</p>																									
Corrective Action	Install a protective cover for the gateway control module which will protect the part from liquid ingress. In addition, on vehicles produced until end of August 2021, the dealer will also seal the insufficient underbody seam.																									
Precautions	Several warning messages will appear if the gateway control module shuts down. The error messages occur due to the interrupted communication between several systems. Even though several systems are displaying a malfunction, not all of these systems are impacted. Customers seeing error messages are advised to make arrangements to have the vehicle diagnosed/repared by an authorized Audi dealer without delay.																									
Code Visibility	On or about January 18, 2022, the campaign code was applied to affected vehicles.																									
Owner Notification	Owner notification took place in January 2022. Owner letter examples are included in this bulletin for your reference.																									
Additional Information	Please alert everyone in your dealership about this action, including Sales, Service, Parts and Accounting personnel. Contact Warranty if you have any questions.																									

The repair information in this document is intended for use only by skilled technicians who have the proper tools, equipment and training to correctly and safely maintain your vehicle. These procedures are not intended to be attempted by "do-it-yourselfers," and you should not assume this document applies to your vehicle, or that your vehicle has the condition described. To determine whether this information applies, contact an authorized Audi dealer. ©2022 Audi of America, Inc. and Audi Canada. All Rights Reserved.

IMPORTANT REMINDER ON VEHICLES AFFECTED BY SAFETY & COMPLIANCE RECALLS

New Vehicles in Dealer Inventory: It is a violation of federal law for a dealer to deliver a new motor vehicle or any new or used item of motor vehicle equipment (including a tire) covered by this notification under a sale or lease until the defect or noncompliance is remedied. By law, dealers must correct, prior to delivery for sale or lease, any vehicle that fails to comply with an applicable Federal Motor Vehicle Safety Standard or that contains a defect relating to motor vehicle safety.

Pre-Owned Vehicles in Dealer Inventory: Dealers should not deliver any pre-owned vehicles in their inventory which are involved in a safety or compliance recall until the defect has been remedied.

Dealers must ensure that every affected inventory vehicle has this campaign completed before delivery to consumers.

Parts Information

Parts Control Type:
Upper Order Limit

Parts will be managed with a weekly Upper Order Limit. Please see Parts On Command (POC) for your Upper Order Limit quantity.

Initial Allocation:
YES

Dealers will be sent an initial allocation prior to customer notification. If no initial allocation was received, please reference the Repair Projection Tool (below) to view your potential VIN population.

Repair Projection Tool:
(right click to open)



Criteria	Quantity	Part Number	P.O.C. Part Description	Ordering Method
01	1	80A-907-577-C	COVER	UOL
	2	N -107-370-01	NUT	UOL
	2	80A-886-373	GROMMET	UOL
02	0.2	D -476-KD1-M2	SEALANT	UOL

NOTE

The specified part numbers reflect the status at the start of this action. Interim updates made in ETKA can cause a listed part number to become unavailable. In this case, the new part number specified in ETKA should be used.

Claim Entry Instructions

The labor times listed here may differ from the labor operations and labor times listed in ELSA.

After campaign has been completed, enter claim as soon as possible to help prevent work from being duplicated elsewhere. Attach the Elsa screen print showing action open on the day of repair to the repair order.

If customer refused campaign work:

- ✓ U.S. dealers: Submit the request through Audi Warranty Online under the Campaigns/Update option.
- ✓ Canada dealers: Upload the repair order [signed by customer] to Audi WIN/Operations/Campaign Closure.

Service Number	90S9		
Damage Code	0099		
Parts Vendor Code	002		
Claim Type	Sold vehicle: 7 10 Unsold vehicle: 7 90		
Causal Indicator	Mark COVER* as causal part		
Vehicle Wash/Loaner	Do not claim wash/loaner under this action		
Vehicles may have more than one criteria. Complete and claim all applicable criteria on <u>one</u> claim.			
Criteria I.D.	01		
	Remove rear bench seat. Install protective cover over gateway control module.		
	LABOR		
	Labor Op	Time Units	Description
	9035 49 99	45	Install protective cover
	PARTS		
	Quantity	Part Number	Description
	1.00	80A907577C	COVER*
	2.00	80A886373	GROMMET
	2.00	N 10737001	HEX. NUT, SELF-LOCKING

Continued on next page

Criteria I.D.	01 AND 02		
	Remove rear bench seat. Install protective cover over gateway control module. Apply sealant around stud.		
	LABOR		
	Labor Op	Time Units	Description
	9035 50 99	60	Install protective cover and apply sealant
	PARTS		
	Quantity	Part Number	Description
	1.00	80A907577C	COVER*
	2.00	80A886373	GROMMET
	0.20	D 476KD1M2	SEALANT
	2.00	N 10737001	HEX. NUT, SELF-LOCKING

	<p><i>Add ONLY if liquid was found on gateway and gateway required replacement</i></p> <p>NOTE:</p> <p><i>U.S. Dealers - Photos showing liquid or traces of liquid on the gateway must be uploaded to Doc-It. The claim for the gateway will be cancelled if photos are not uploaded.</i></p> <p><i>Canada Dealers - Photos showing liquid or traces of liquid on the gateway must be uploaded to an ATA case. The claim for the gateway will be cancelled if photos are not uploaded.</i></p>		
	LABOR		
	Labor Op	Time Units	Description
	0150 00 00	Time stated on diagnostic protocol	Program new gateway control module
	PARTS		
	Quantity	Part Number	Description
	1.00	SEE ETKA	Gateway control module

Customer Letter Example (USA)

<MONTH YEAR>

<CUSTOMER NAME>

<CUSTOMER ADDRESS>

<CUSTOMER CITY STATE ZIPCODE>

This notice applies to your vehicle: <MODEL YEAR> <BRAND> <CARLINE>, <VIN>

NHTSA: 21V947

Subject: Safety Recall 90S9 – Gateway Control Module

Dear Audi Owner,

This notice is sent to you in accordance with the National Traffic and Motor Vehicle Safety Act. Audi has decided that a defect, which relates to motor vehicle safety, exists in certain 2018-2022 model year Audi vehicles. Our records show that you are the owner of a vehicle affected by this action.

What is the issue?

If liquid reaches and enters the gateway control module, mostly due to a liquid spill on the rear seats, it is being switched off as part of the safety concept. In very rare cases (such as when driving through heavy rain or deep water) there may also be water ingress through an insufficient underbody seam. Water/liquid ingress into the gateway control module may lead to various internal errors due to short circuits within the control unit.

The gateway control module has a safety concept in case implausible signals are detected in the control unit. If such implausible signals are detected, the gateway switches off its function in order to avoid unwanted vehicle reactions. The vehicle remains steerable and the brake system is fully operable. The engine goes into emergency mode and remains in operation with reduced power.

Unexpected reduced engine power may create an increased risk of a crash in certain driving situations.

What will we do?

To correct this defect, your authorized Audi dealer will install a protective cover for the gateway control module, which will protect the part from liquid ingress. In addition, on vehicles produced until end of August 2021, the dealer will also seal the insufficient underbody seam. This work will take about an hour to complete and will be performed for you free of charge. Please keep in mind that your dealer may need additional time for the preparation of the repair, as well as to accommodate their daily workshop schedule.

What should you do?

Please contact your authorized Audi dealer without delay to schedule this recall repair. For your convenience, you can also visit www.audiusa.com and click on the "Find a Dealer" link to locate a dealer near you and schedule this service.

Precautions you should take

Several warning messages will appear if the gateway control module shuts down. The error messages occur due to the interrupted communication between several systems. Even though several systems are displaying a malfunction, not all of these systems are impacted. Customers seeing error messages are advised to make arrangements to have the vehicle diagnosed/repared by an authorized Audi dealer without delay.

Lease vehicles and address changes

If you are the lessor and registered owner of the vehicle identified in this action, the law requires you to forward this letter immediately via first-class mail to the lessee within ten (10) days of receipt. If you have changed your address or sold the vehicle, please fill out the enclosed prepaid Owner Reply card and mail it to us so we can update our records.

Can we assist you further?

If your authorized Audi dealer fails or is unable to complete this work free of charge within a reasonable time, please contact Audi Customer Experience at 1-800-253-2834 or via our "Contact Us" page at www.audiusa.com.

Checking your vehicle for open Recalls and Service Campaigns

To check your vehicle's eligibility for repair under this or any other recall/service campaign, please visit the **Recall/Service Campaign Lookup** tool at www.audiusa.com and enter your Vehicle Identification Number (VIN).

If you still cannot obtain satisfaction, you may file a complaint with: The Administrator, National Highway Traffic Safety Administration, 1200 New Jersey Avenue, SE., Washington, DC 20590; or call the toll-free Vehicle Safety Hotline at 1-888-327-4236 (TTY: 1-800-424-9153); or go to <http://www.safercar.gov>.

We apologize for any inconvenience this matter may cause; however we are taking this action to help ensure your safety and continued satisfaction with your vehicle.

Sincerely,

Audi Customer Protection

Customer Letter Example (Canada)

<MONTH YEAR>

<CUSTOMER NAME>

<CUSTOMER ADDRESS>

<CUSTOMER CITY STATE ZIPCODE>

This notice applies to your vehicle: <MODEL YEAR> <BRAND> <CARLINE>, <VIN>

Transport Canada Recall: 2021-740

Subject: Safety Recall 90S9 – Gateway Control Module

Dear Audi Owner,

This notice is sent to you in accordance with the requirements of the *Motor Vehicle Safety Act*. This is to inform you that your vehicle may contain a defect that could affect the safety of a person. Our records show that you are the owner of a vehicle affected by this action.

What is the issue? If liquid reaches and enters the gateway control module, mostly due to a liquid spill on the rear seats, it is being switched off as part of the safety concept. In very rare cases (such as when driving through heavy rain or deep water) there may also be water ingress through an insufficient underbody seam. Water/liquid ingress into the gateway control module may lead to various internal errors due to short circuits within the control unit.

The gateway control module has a safety concept in case implausible signals are detected in the control unit. If such implausible signals are detected, the gateway switches off its function in order to avoid unwanted vehicle reactions. The vehicle remains steerable and the brake system is fully operable. The engine goes into emergency mode and remains in operation with reduced power.

Unexpected reduced engine power may create an increased risk of a crash in certain driving situations.

What will we do? To correct this defect, your authorized Audi dealer will install a protective cover for the gateway control module which will protect the part from liquid ingress. In addition, on vehicles produced until end of August 2021, the dealer will also seal the insufficient underbody seam. This work will take about an hour to complete and will be performed for you free of charge. Please keep in mind that your dealer may need additional time for the preparation of the repair, as well as to accommodate their daily workshop schedule.

What should you do? Please contact your authorized Audi dealer without delay to schedule this recall repair.

Precautions you should take Several warning messages will appear if the gateway control module shuts down. The error messages occur due to the interrupted communication between several systems. Even though several systems are displaying a malfunction, not all of these systems are impacted. Customers seeing error messages are advised to make arrangements to have the vehicle diagnosed/repared by an authorized Audi dealer without delay.

Lease vehicles and address changes If you are the lessor and registered owner of the vehicle identified in this letter, you shall forward this letter (and any subsequent notice, if applicable) to the lessee within ten (10) days of receipt. If you have changed your address or sold the vehicle identified in this letter, please fill out the enclosed prepaid Owner Reply Card and mail it to us so we can update our records.

Can we assist you further? If your authorized Audi dealer fails or is unable to complete this work free of charge within a reasonable time, please contact Audi Customer Relations Monday through Friday from 8AM to 8PM EST at 1-800-822-2834 or via our "Contact Audi Canada" page at www.audi.ca.

We apologize for any inconvenience this matter may cause; however we are taking this action to help ensure your safety and continued satisfaction with your vehicle.

Sincerely,

Audi Customer Protection

Repair Overview



Criteria 01

- Install protective cover over Gateway Control Module.

Criteria 02:

- Apply sealant around a stud, which is open to the exterior of the vehicle.

! NOTE

- These repair instructions may differ from the labor operations and labor times listed in ELSA.
- Damages resulting from improper repair or failure to follow these work instructions are the dealer's responsibility and are not eligible for reimbursement under this action.
- This procedure must be read in its entirety prior to performing the repair.
- Due to variations in vehicle equipment and options, the steps/illustrations in this work procedure may not identically match all affected vehicles.
- Diagnosis and repair of pre-existing conditions in the vehicle are not covered under this action.
- When working during extreme temperatures, it is recommended that the vehicle be allowed to acclimate inside the shop to avoid temperature-related component damage/breakage.

Required Tools



Cartridge Gun
-VAG1628-
(or equivalent)

Repair Instruction

Section A - Check for Previous Repair

Applicable criteria ID(s)	Campaign/Action Status
01 ← 2	Open ← 1

EXAMPLE

Campaign/Action	Start	Designation
← 3	2015-11-10	W-SERV_ACT -
	2018-12-13	RECALL -
	2017-05-16	A-RECALL -

EXAMPLE

- Enter the VIN in Elsa and proceed to the “Campaign/Action” screen.

TIP

On the date of repair, print this screen and keep a copy with the repair order.

- Confirm the Campaign/Action is open <arrow 1>. If the status is closed, no further work is required.
- Note the Applicable Criteria ID <arrow 2> for use in determining the correct work to be done and corresponding parts associated.

CRITICAL REPAIR STEP

 **STOP!** 

If multiple software update Campaign/Actions are open, they must be performed in order of the Start date <arrow 3>. The oldest should be performed first.

- **All Safety Recalls must be completed prior to completing this campaign.**
- **Proceed to Section B.**

Section B – Installing Protective Cover (Criteria 01)

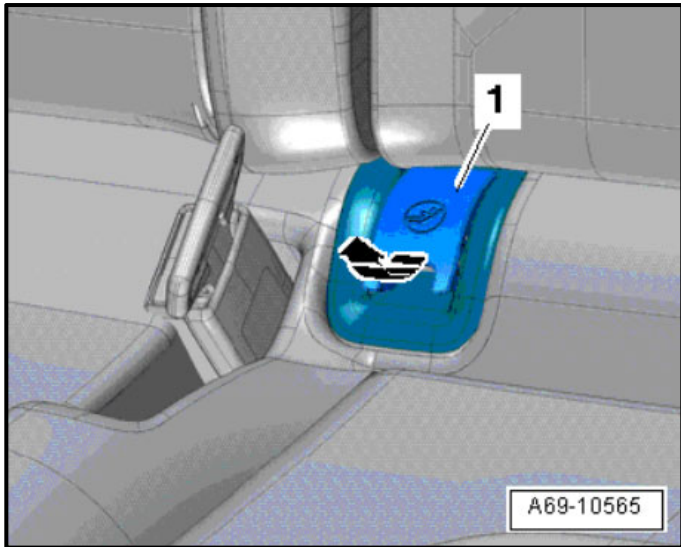

Remove child seat anchor guides from driver rear seat bench:

- Unclip the child seat anchor cover <1> from the anchor in direction of <arrow> and remove.

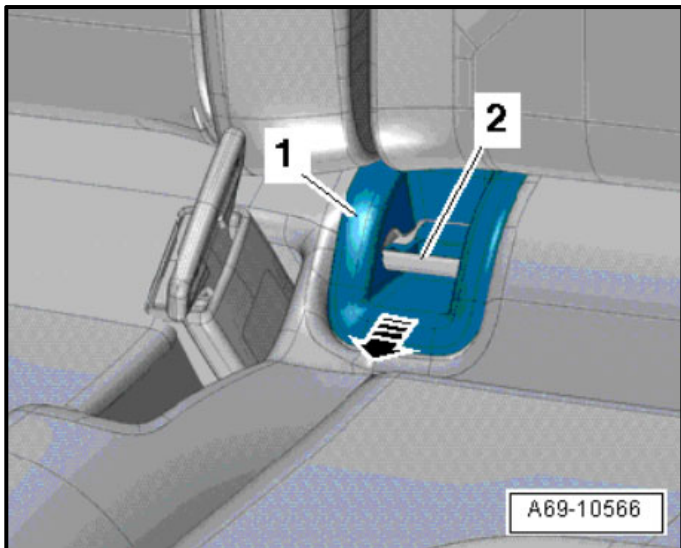

- Push the child seat anchor guide <1> downward according to the cut-out, and disengage it from the anchor <2>.
- Pull out the child seat anchor guide toward the front in direction of <arrow> and move it to the side with the strap.
- If necessary, disengage the strap and remove the child seat anchor guide.

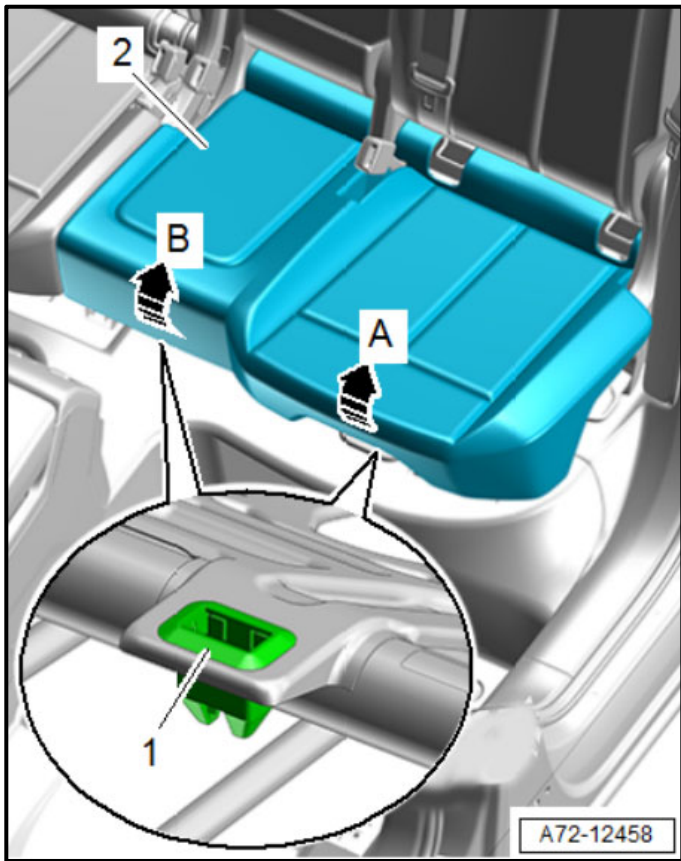

Remove driver side rear seat bench:

- Grab under the seat cushion <2> on one side with both hands.
- Using both hands, pull the seat cushion upward with force in direction of <arrow A> to release the seat cushion from the mount <1>.
- Repeat the procedure on the other side of the seat cushion in direction of <arrow B>.
- Tilt the seat cushion upward and disengage at the back of the seat frame.
- Disconnect seat heating connectors (if equipped).

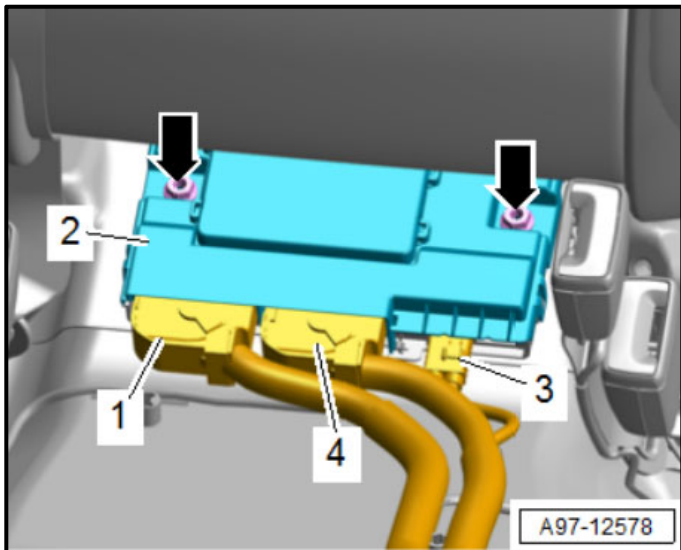

Unbolt gateway control module:

⚠ NOTE

The electrical connectors remain connected.

- Remove and discard the nuts <arrows>.

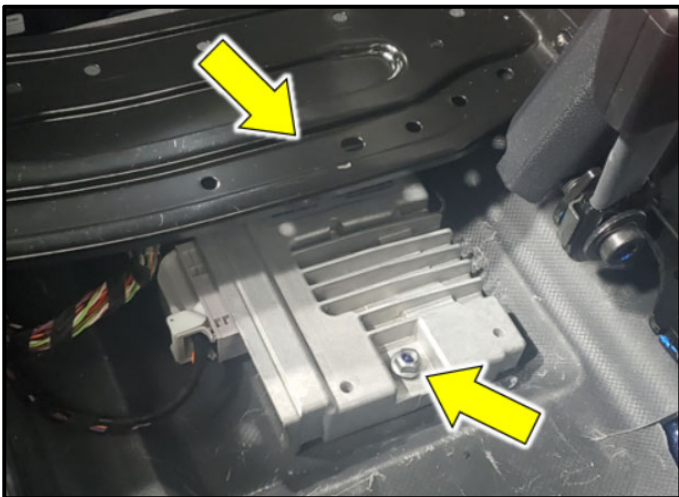

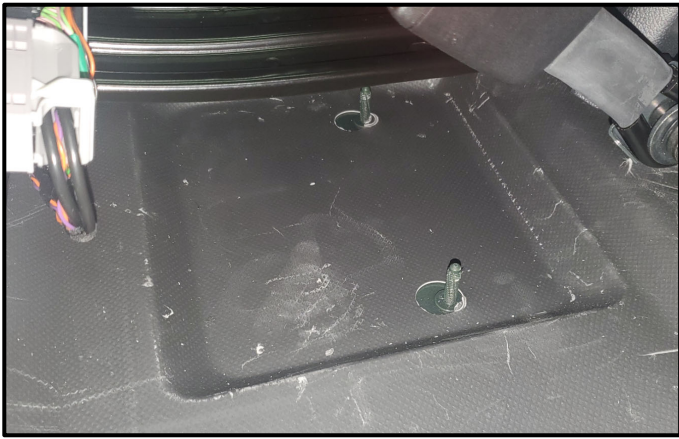

- Inspect the recessed well that the gateway was in.
- If any liquid or traces of liquid are present:
 - Take photos showing liquid or traces of liquid are present.
 - U.S. Dealers - Upload photos to Doc-It.
 - Canada Dealers - Upload photos to an ATA WEB Ticket
 - The gateway control module must be replaced.
 - The connector pins must be inspected and any corroded pins replaced.

! NOTE

If liquid is found on gateway, it is not necessary to contact Audi Warranty.
 If photos are not uploaded to Doc-It (U.S. Dealers) or to an ATA WEB Ticket (Canadian dealers), the claim for the gateway control module will be cancelled.

! NOTE

If connector pins are damaged or other consequential damage is found:

- U.S. dealers: Upload documentation to Doc-It for review. Contact Audi Warranty for authorization.
- Canadian dealers: Create an ATA WEB ticket and attach documentation for review.

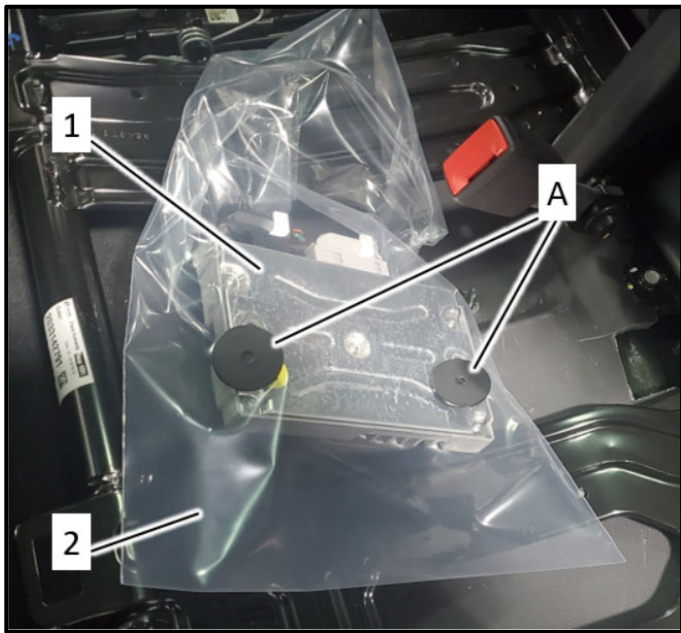

Install cover over gateway control module:

Part Number	Part Description
80A-907-577-C	Protective cover

- Place the gateway control module <1> into protective cover <2>.
- The gaskets <A> will be placed over the studs on the floor.

i TIP

It's also possible to install the cover onto the studs first, then install the gateway control module into the cover.



Reinstall gateway control module:

- The gateway must be fastened with new nuts.
- Tightening the nuts must be performed inside the protective cover, as shown.
- Torque the new nuts to 5 Nm.

Part Number	Part Description
N -107-370-01	Self-locking nut





Final positioning of protective cover:

- Smooth out the protective cover and place the open end of the cover under the carpet <1>.

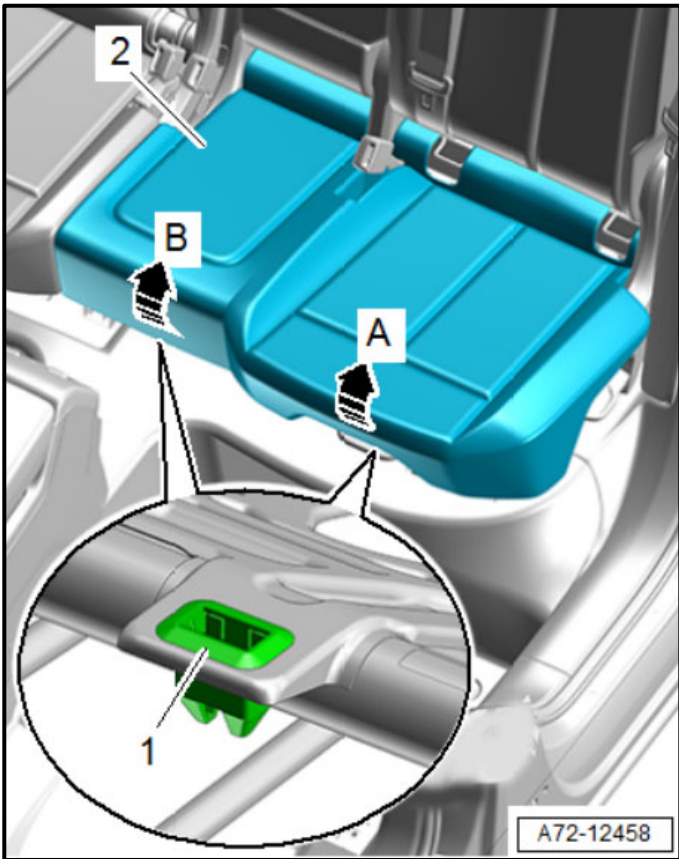

Reinstall seat bench and child seat anchor covers:

- Installation is the reverse order of removal.
- Seat grommets <1> must be replaced.

Part Number	Part Description
80A-886-373	Seat grommet

Vehicles with Criteria 01 and 02:

- Proceed to Section C

Vehicles with only Criteria 01:

- Proceed to Section D

Section C – Sealing Around Stud (Criteria 02)

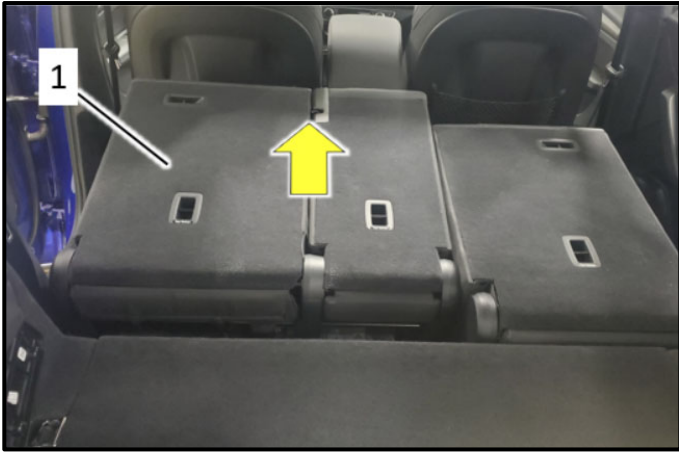

Position driver side rear seat:

- Slide driver side rear seat forward, as shown.

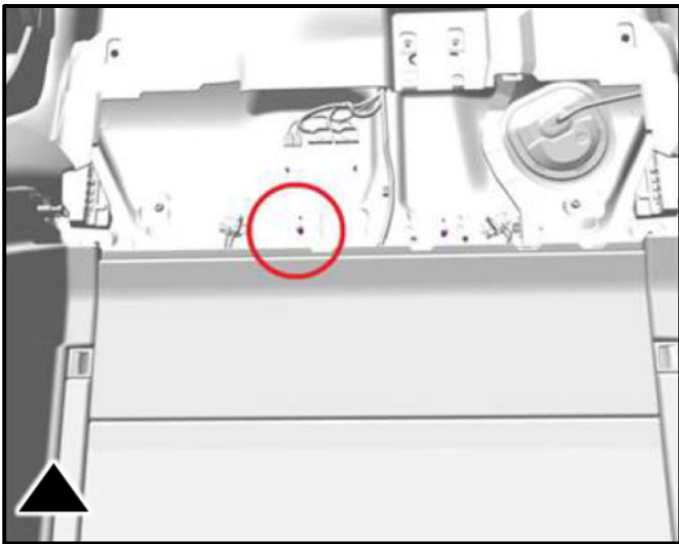

Prep area for sealant:

- The stud and area requiring sealant shown <circle>.

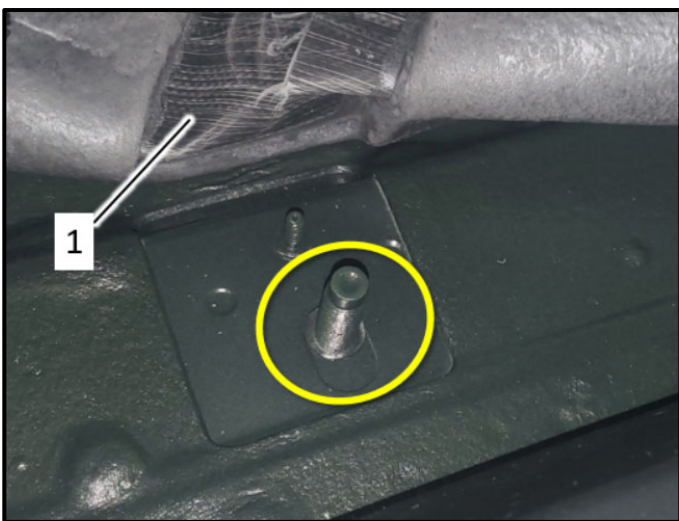

- Position floor insulation <1> out of the way.
- Ensure area is free of dirt and debris.
- Clean area to be sealed <circle> with isopropyl alcohol.
- Allow cleaning solution to completely dry.

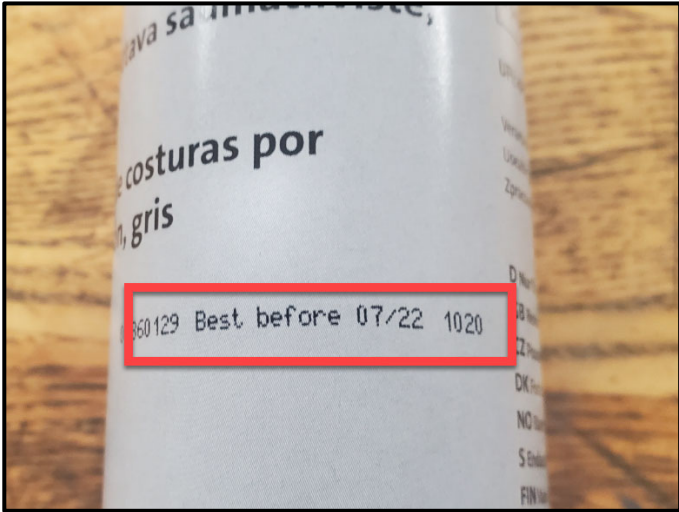

Apply sealant:

NOTE

Pay attention to the “Best before” date on the sealant.



Part Number	Part Description
D -476-KD1-M2	Sealant

- Apply sealant around stud as shown.
- Ensure the base of the stud is fully encapsulated with sealant.
- Reposition floor insulation in its original position.
- Bring seat back to its original position.

Proceed to Section D

Section D – Campaign Completion Stamp

I certify that this campaign
has been performed in strict
accordance with the applicable
Audi repair procedure.

SAGA Code: _____
Technician: _____
Date: _____

Item#: AUD4927ENG

-OR-

Je certifie que cette
campagne de rappel a été
exécutée suivant les strictes
directives de réparation
d'Audi

Code de SAGA: _____
Technicien: _____
Date: _____

Item # AUD4927FRE

- Once the campaign has been completed, the technician should stamp the repair order.
- Stamps are available for ordering through the Compliance Label Ordering Portal.