

Repair Procedure – [Updated October 11, 2022 Page 4, 10 and 21.](#)

Safety Recall 5321K – Multi-Model Fuel Pump May Fail – All Models

A. VEHICLE INSPECTION PROCEDURE

1. Verify that the vehicle is within the following ranges:

NOTE: Mazda2 and Mazda3 vehicles in 5321K were only sold in Canada, Mexico and/or US Territories but must be repaired at any Mazda dealer in North America.

Model	Subject VIN range	Subject production date range
2018-2019MY CX-5 (KF)	JM3KF**** J* 387268 – 476254 JM3KF**** K* 500024 – 514334	From April 3, 2018 through October 27, 2018
2019MY CX-3 (DK)	JM1DK**** K* 403654 – 428073	From April 10, 2018 through November 6, 2018
2018-2019MY CX-9 (TC)	JM3TC**** J0 229736 – 237357 JM3TC**** K0300008– 308082	From April 16, 2018 through October 17, 2018
2018-2019MY Mazda6 (GL)	JM1GL**** J1 313085 – 329168 JM1GL**** K1 314118 – 329175	From April 5, 2018 through October 24, 2018
2018-2019MY MX-5 (ND)	JM1ND**** J0 205791 – 206202 JM1ND**** K0 300011 – 303267	From April 5, 2018 through October 29, 2018
Vehicles sold only in the US Territories. No vehicles below were sold in the Continental USA.		
2019-2020MY Mazda2 (DJ)	3MDDJ**** KM 309487 – 316139 3MDDJ**** LM 400466 – 401990	From November 1, 2018 through January 13, 2020
2018MY Mazda3 (BN)	JM1BN**** J1 190558 – 199538	From April 12, 2018 through October 31, 2018

The asterisk symbol “*” can be any letter or number.

- If the vehicle is one of the above listed, proceed to Step 2.
- If the vehicle is not within the above ranges, return vehicle to the customer or inventory.

2. Perform a Warranty Vehicle Inquiry using your eMDCS System and inspect vehicle for Campaign Labels **Recall 5321K** attached to the vehicle’s hood. Refer to eMDCS System - Warranty Vehicle Inquiry Results table below.

NOTE: Be sure to verify Recall number as the vehicle may have multiple Recall labels.

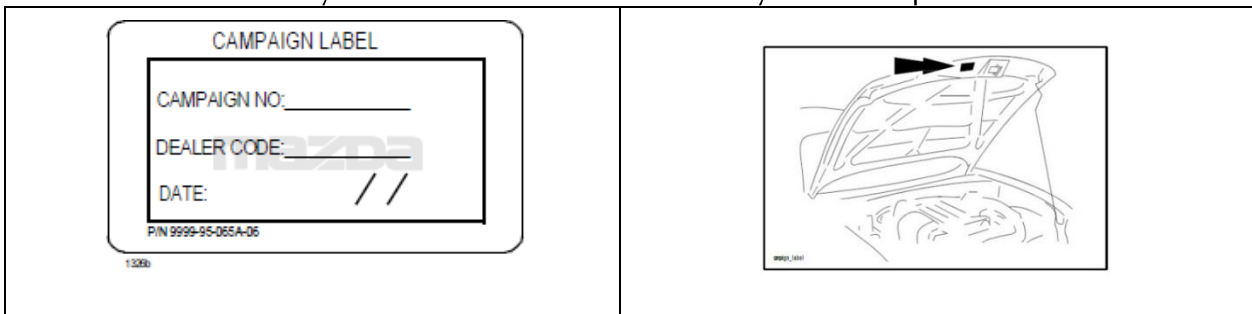

eMDCS System - Warranty Vehicle Inquiry Results:

If eMDCS displays:	Campaign Label is:	Action to perform:
If no repair date is displayed on the line with RECALL 5321K, it has not been completed on this vehicle	Present	Contact the Mazda Warranty Department at (877) 727-6626, Option 3.
	Not present	--Proceed to "REPAIR PROCEDURE".
If repair date is displayed on the line with RECALL 5321K, it has been completed on this vehicle	Present	Return vehicle to inventory or customer.
	Not present	Complete a label and apply to vehicle's hood.
RECALL 5321K is not displayed	Does not apply	Recall does not apply to this vehicle. Return vehicle to customer.

B. REPAIR PROCEDURE

- 1. Remove the Fuel Pump Unit per MGSS. For MX-5 Refer to 5321K MX-5 Repair Supplement – for the specific procedure to remove from the vehicle.**

Click below for the links to the standard procedure.

[WITHOUT CYLINDER DE-ACTIVATION - FUEL PUMP REMOVAL](#)

[WITH CYLINDER DE-ACTIVATION – FUEL PUMP REMOVAL](#)

NOTE: FUEL PUMP CAP REMOVAL – All CX-3 & Mazda2 (US Territory and Mexico) only. To remove the pump, you must use SST 49 F042 001 which is a required SST for all Mazda dealerships.

CX-3 and Mazda2 FUEL PUMP CAP REMOVAL

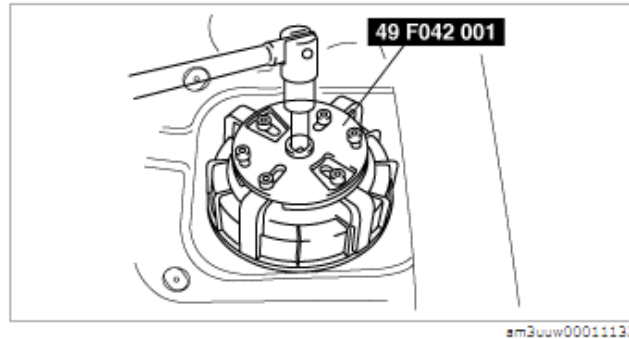

Fuel Tanks Screws – Rusted/Sheared (all Models except CX-3 and Mazda2):

We encourage you to order Mazda part # 9983-30-408 which is on backorder. Until supply is readily available, locally sourced screws are allowed following the specific guidelines below. One source for the screws that is nationally available in the USA is McMaster-Carr SKU 94387A240

<https://www.mcmaster.com/94387A240/> however, substitutes meeting specifications below are acceptable for use.

If you need a Fuel Tank assembly, you must still contact Dealer Recall Help. Use of screws only does not require a contact to Dealer Recall Help.

Fuel Tank Screw specifications

- **Dimensions are 4mm with 0.7mm pitch and 8mm length. This has to match.**
- **Material: Steel with Zinc Coating.**
- **Hardness factor is 4.8 which is the nominal hardness of a screw. This must be the minimum hardness that is usable.**
- **Phillips head and should be ~ 2.6mm thick with a 7mm head size.**
- **Old screws can be discarded.**

2. Fuel pump disassembly/assembly procedure

This repair procedure has combined both Type A and Type B fuel pumps which has the same removal/installation procedure. It is also the same in the supplemental VIDEO's below which must be reviewed prior to repair.

Please watch both videos prior to repairing:

[Type A Repair video link](#)

[Type B Repair video link](#) NOTE: This link shows a CX-5 Non-turbo AWD pump removal

CAUTION: The disassembly surface must be clean and flat as in the videos. Do not disassemble on a non-flat surface. Be very careful with handling the FDM unit as the fittings or hoses can break OR crack during removal or reassembly of the FDM unit. Damage caused by technician error is not reimbursable under the campaign or warranty.

However, there are two structural differences, which is explained below.

- 'Type B' has applied suction pipe.

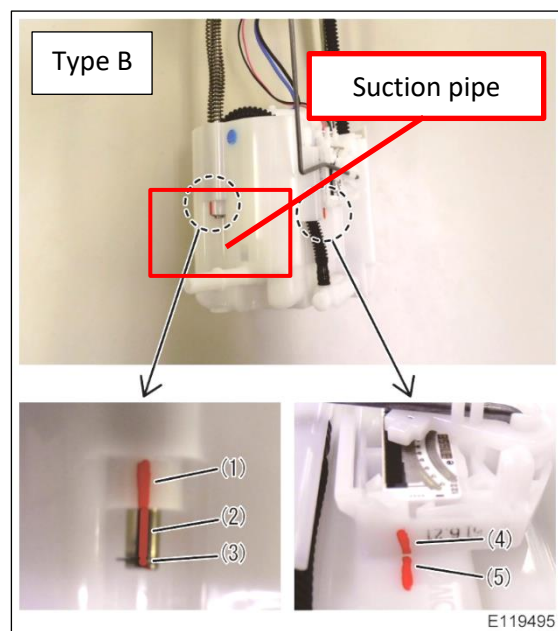
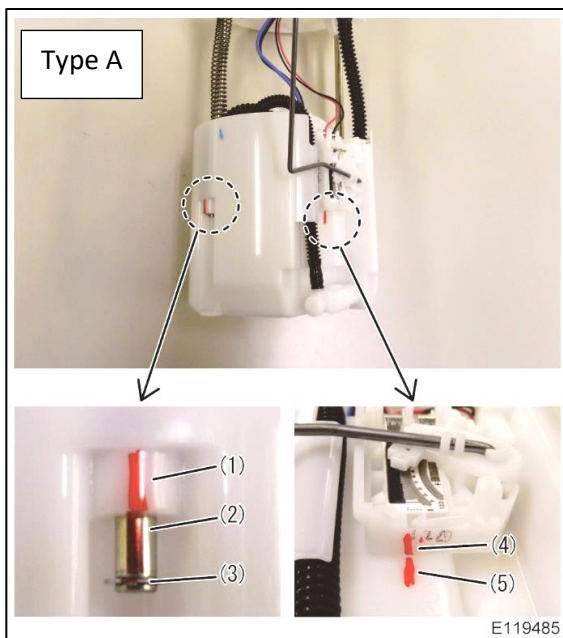

Type B has the valve referred to in the tube routing diagram.

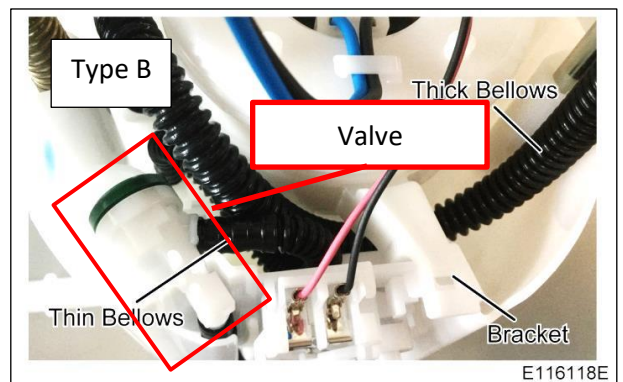
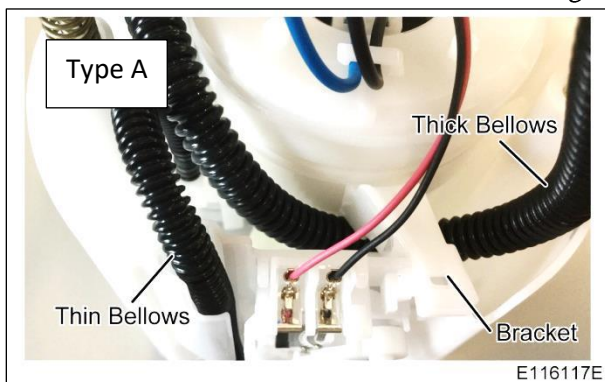

Fuel pump disassembly procedure

Discharge the fuel inside the fuel pump. If all the fuel does not come out with a single discharge, repeat discharging two or three times.

CAUTION: Fuel that remains in the filter or pump may spill, always discharge the fuel over a tray or other container.

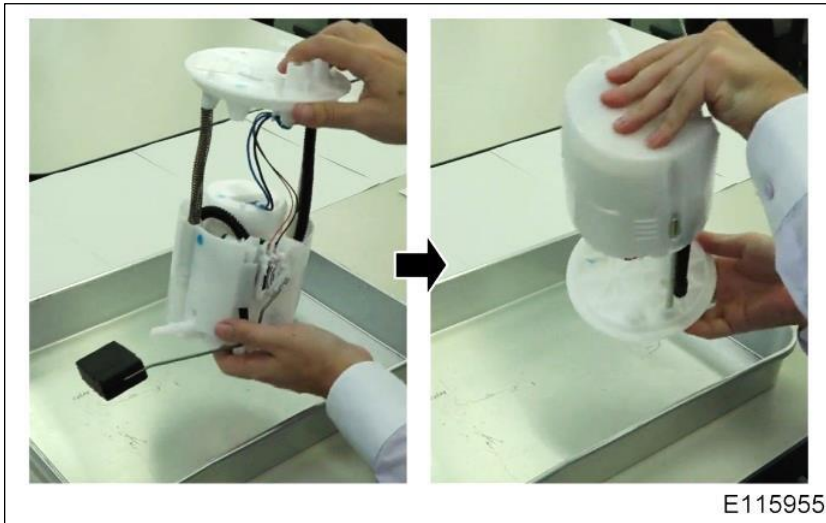

1. Mark the (1) rod guide, (2) rod, (3) E-ring, (4) fuel gauge sender and (5) reservoir cup with a marker before disassembly to avoid re-assembling incorrect.

CAUTION: Be careful with pump disassembly as you could damage the body pump hose (Red Circle Type A and B). Breaking this fitting(s) will not be reimbursable under the recall.

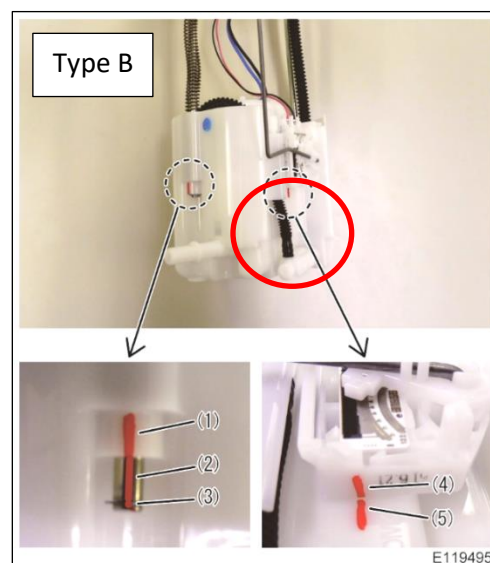
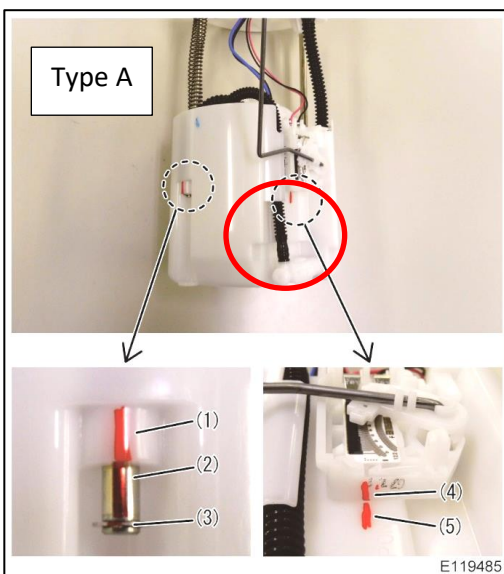

2. Check the routing condition of the wire harness and tube. The routing is the same during reassembly.

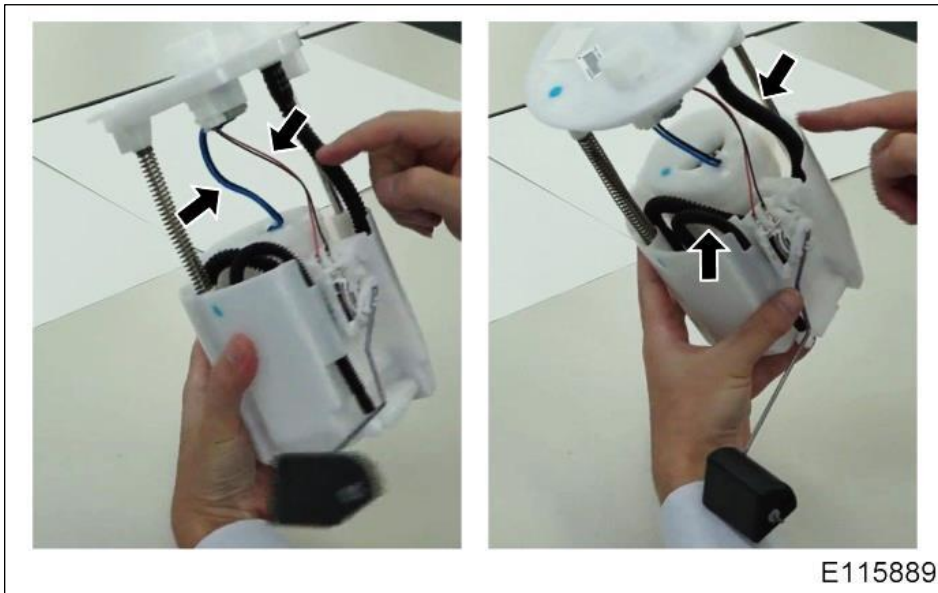

NOTE: Check carefully because the routing may differ by type.

- Thick bellows tube routing (either over or under the bracket)
- Thin bellows tube routing (bend position)
- Wire harness routing (clamp position)

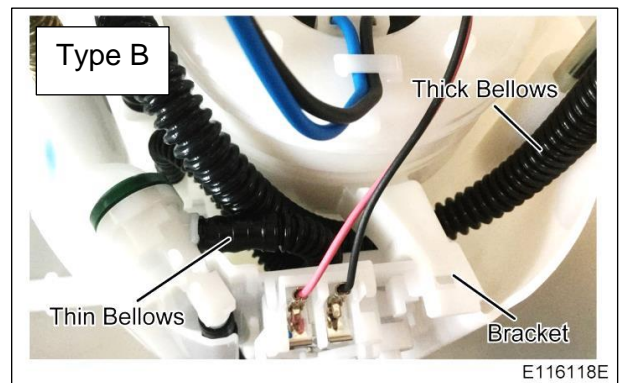
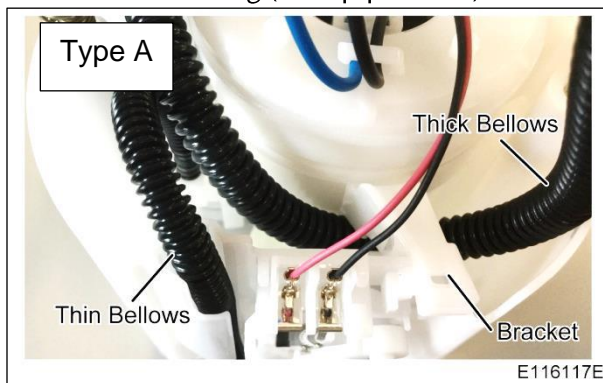

3. Remove the wire harness from the clamp. Spread the clamp and remove the wire while ensuring that the wire harness is not damaged.

CAUTION:

Be aware that if the clamp is pulled out on an angle without opening the clamp, the coating may rip, the wire harness may be disconnected, or the fuel pump or fuel gauge sender may not run. Also, be aware that the clamp may be damaged if the clamp is spread too wide.

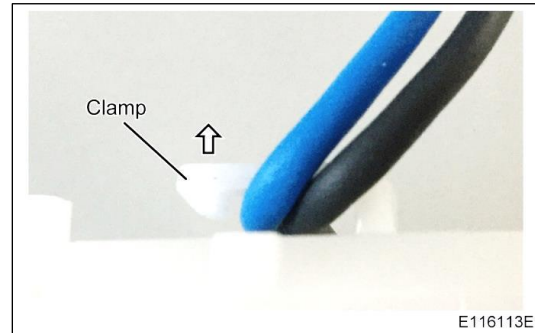
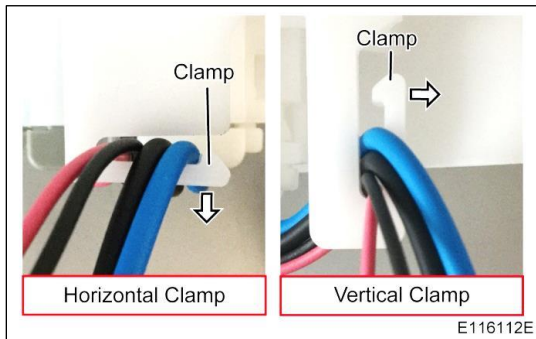
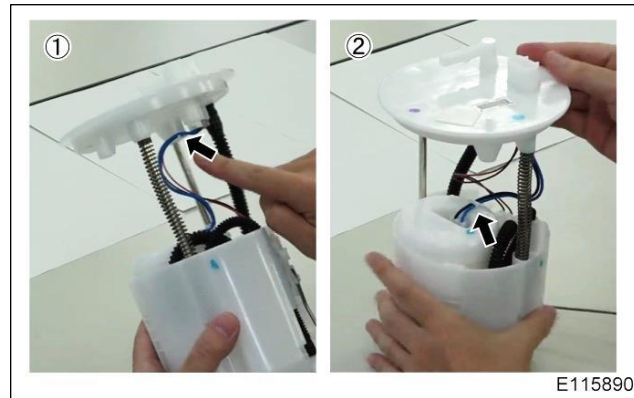

IMPORTANT NOTE: Check for broken, cut, frayed or chafed wire on FDM units as in the photo (1) below.

- If found to be damaged, the harness must be replaced. ***Be very careful with the harness as it can easily be damaged.***
- Part ordering: **Order the harness from the Restricted Parts Ordering (RPO) Screen through the Dealer Assistance Group (DAG).** You must have an open RO and the vehicle must be down. Depending on the model, there are different harnesses and the Parts & Warranty information has been updated with the correct part numbers.

Harness Part Number (Harness Length in red)	Model
292135-0021 (20CM)	CX-5
292135-0321 (17.5CM)	CX-3 (2WD), Mazda6, CX-9, Mazda3*, Mazda2*
292135-1074 (25CM)	MX-5
292135-0181 (22.5CM)	CX-3 (AWD)

*Mexico, Canada or US Territory vehicles only

- While waiting for the countermeasure part to arrive please continue the repair and install the new harness on page 19 at repair step 7.

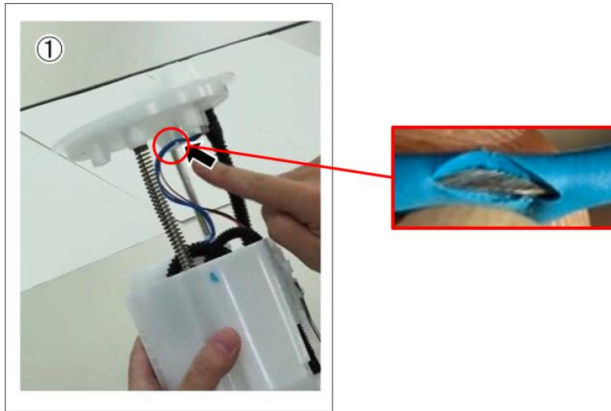

4. Remove the connector of the wire harness (with the flange).

CAUTION:

- Pull out the connector with the lock pushed.
- Do not grasp the wire harness and pull out.
- Be aware that if the wire harness is grasped and pulled out, the wire harness may be disconnected, or the fuel pump or fuel gauge sender may not run.

NOTE:

Use a flathead screwdriver wrapped in protective tape for removal. While pushing the lock with a screwdriver, pull out the connector straight down.

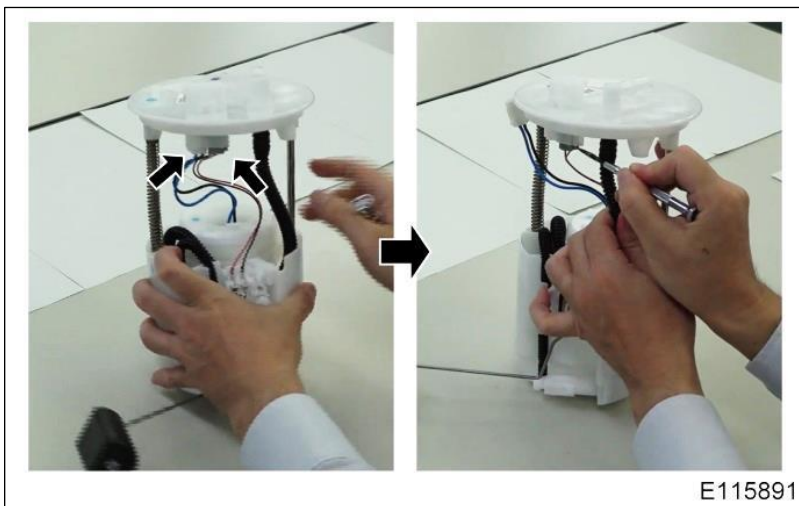

5. Remove the fuel gauge sender.

CAUTION:

While working, do not bend the arm of the fuel gauge sender, and do not touch resistance substrates or contacts to prevent problems.

NOTE:

Use a flathead screwdriver wrapped in protective tape to release the lock, push up from below, and then remove.

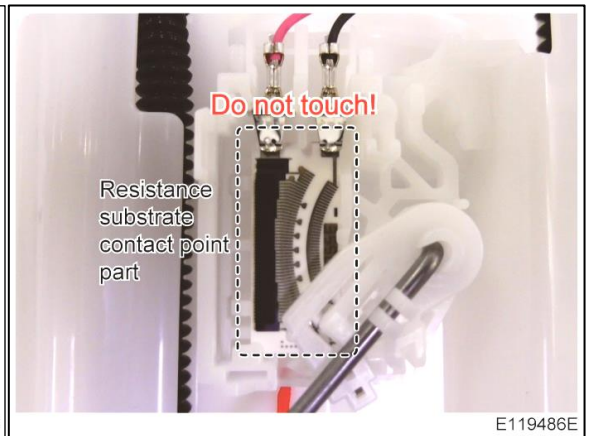
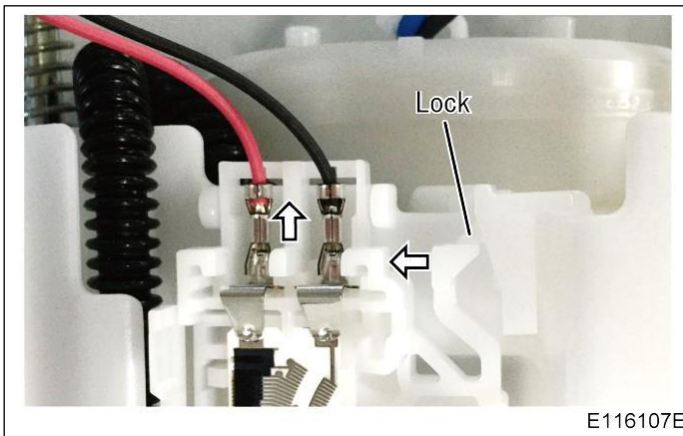
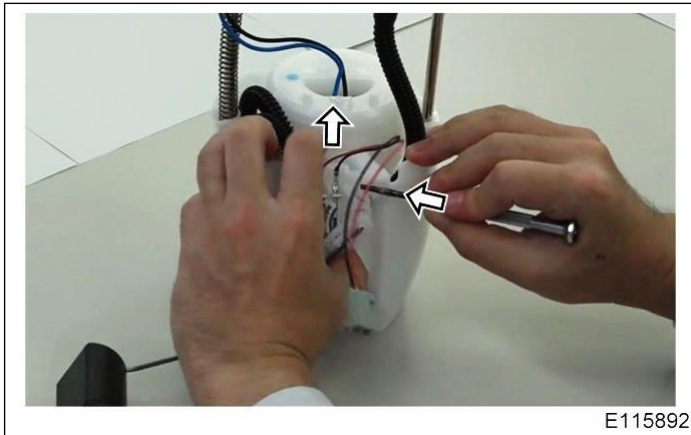

NOTE: Use a flathead screwdriver wrapped in protective tape for removal.

CAUTION: Be aware that the clamp may be damaged if the clamp is spread too wide.

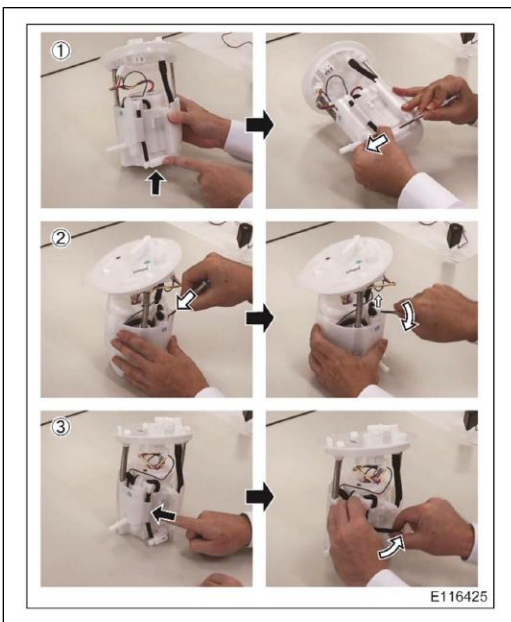

① Remove the jet pump for pumping.

② Remove the transfer jet pump.

③ Remove the bellows tube from the

CAUTION:

All AWD models (referred to as "Type B" fuel pump) have a transfer jet pump, however, only the AWD with 2.5L Turbo engine requires removal of the transfer jet pump and black O-ring replacement. When repairing the CX-5 AWD Non-Turbo and CX-3 AWD, the transfer jet pump is not removed and therefore the black O-ring is not required.

Remove the jet pump from the reservoir cup, (do this on the CX-9 & CX-5 Turbo engine AWD only) for Pump Part PYY2-13-350.

Take care not to damage the reservoir cup.

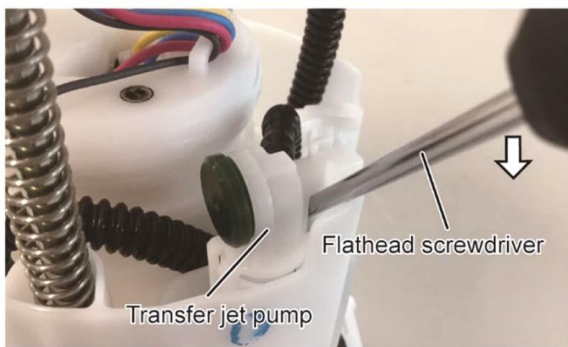

6. Remove the E-ring. Use combination pliers or similar tool for removal.



NOTE:
The E-ring cannot be reused.

7. Remove the bracket. Use a flathead screwdriver wrapped in protective tape for removal of the three locations.

CAUTION: Be aware that the clamp may be damaged if the clamp is spread too wide.

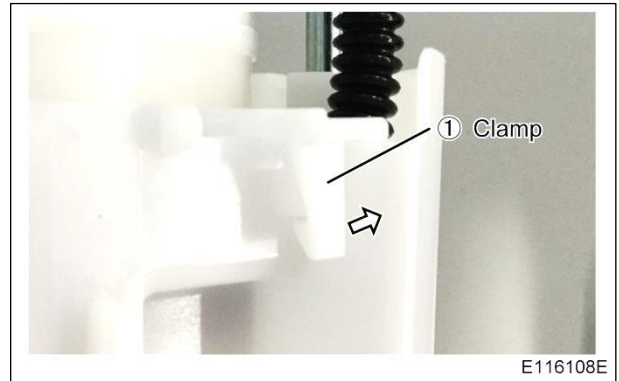
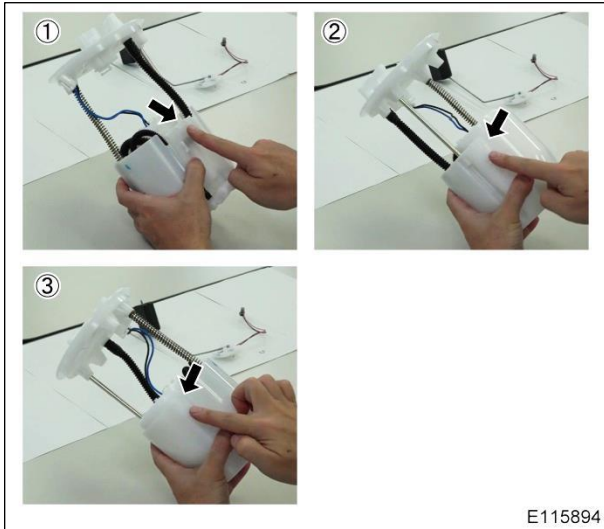

8. Pull out the high-pressure pump from the reservoir cup.

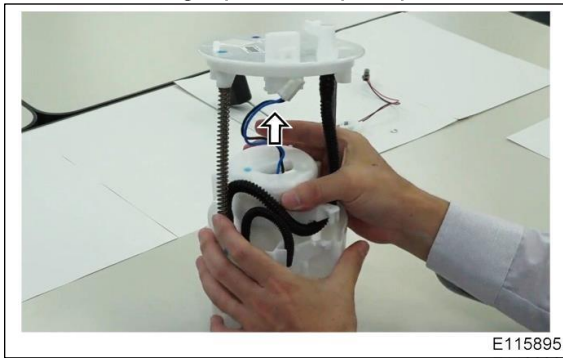

9. Remove the spring from the rod with the spring on it.

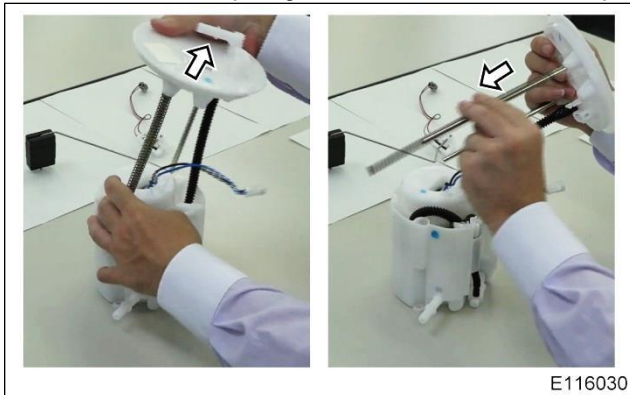

10. Remove the suction filter. Use a flathead screwdriver wrapped in protective tape for removal of the five locations.

CAUTION:

- To prevent dirt and damage of the suction filter.
- Cover so that foreign debris does not get inside the suction filter.
- Be aware that the clamp may be damaged if the clamp is spread too wide.

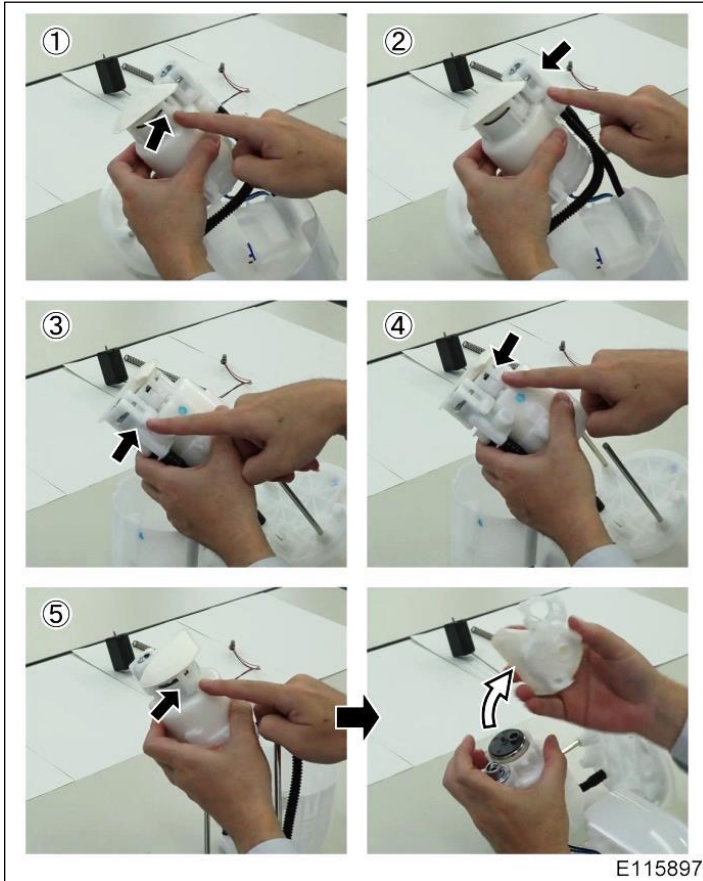

One-valve type

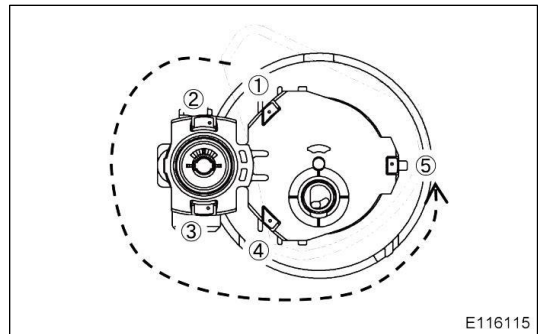

Two-valve type

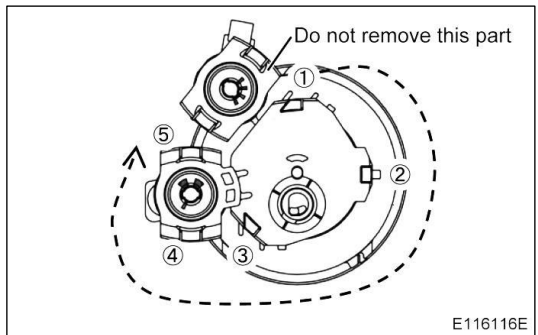

11. Push out the fuel pump using a flathead screwdriver wrapped in protective tape.

CAUTION:

- When the suction filter is reinstalled again, make sure there is no dirt or damage of the filter.
- Make sure that the connector is not damaged.
 - Take precautions when removing the pump as leftover fuel may spill.

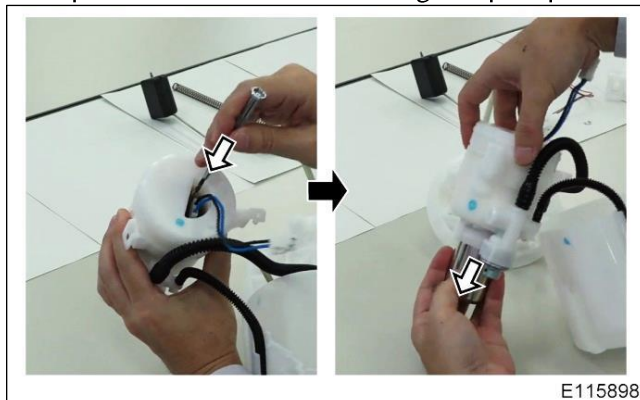

12. If the O-ring remains on the high-pressure pump, use a long hook-like rod to remove it while ensuring that the O-ring seal is not damaged.

CAUTION: Be aware that if the O-ring is not removed, insufficient fuel flow occurs, and due to the double installation of O-rings will cause poor drivability, acceleration problems, engine stalling, and hard start issues.

- O-rings cannot be reused.

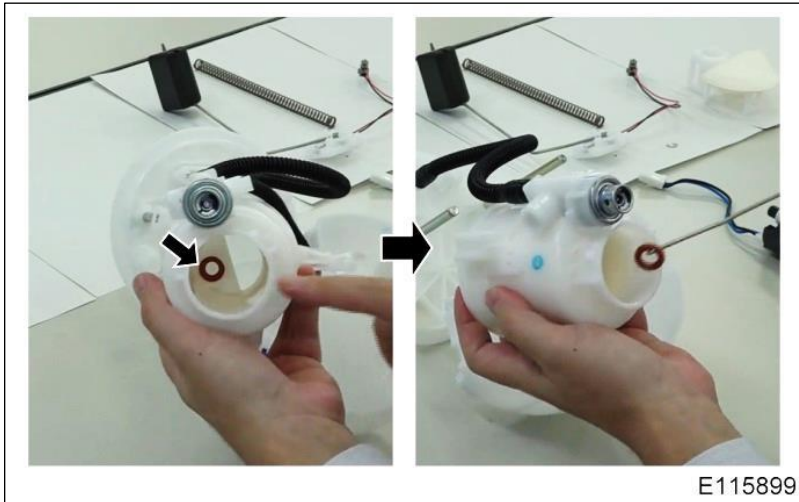

13. Remove the wire harness and spacer from the fuel pump.

CAUTION: Fuel pump and spacer cannot be reused. Mark parts with permanent marker to distinguish reusable and non-reusable parts.

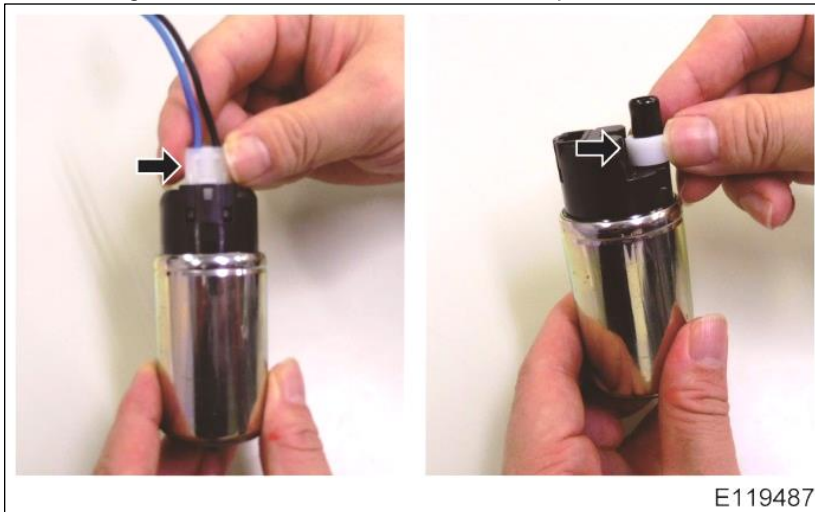

Fuel pump assembly procedure

CAUTION: Make sure that there is no dirt/foreign objects or scratches on the connection parts such as O-ring, spacer, and suction filter etc. before assembling.

1. Install the suction filter in the fuel pump.

CAUTION: During assembly, be careful that the suction filter and fuel pump are not damaged.

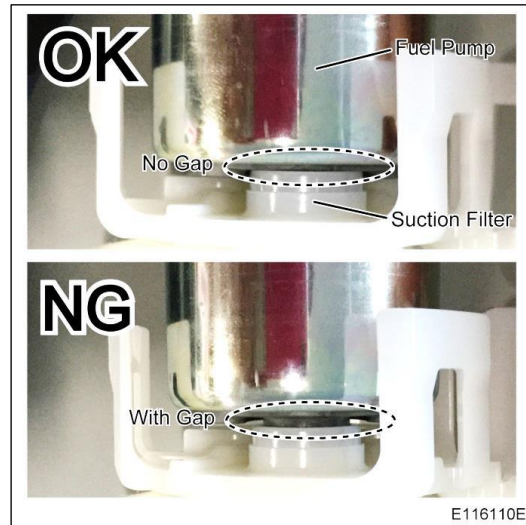
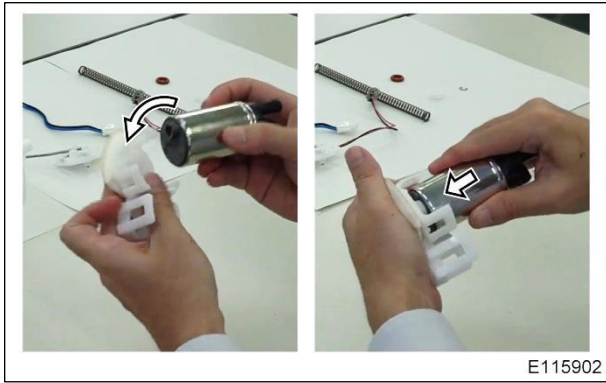

2. Install the new spacer, new O-ring, and wire harness to the new fuel pump.

CAUTION: Be aware that if the O-ring is installed incorrectly or poorly, there will be insufficient fuel flow which will cause poor drivability, acceleration problems, engine stalling, and hard start issues.

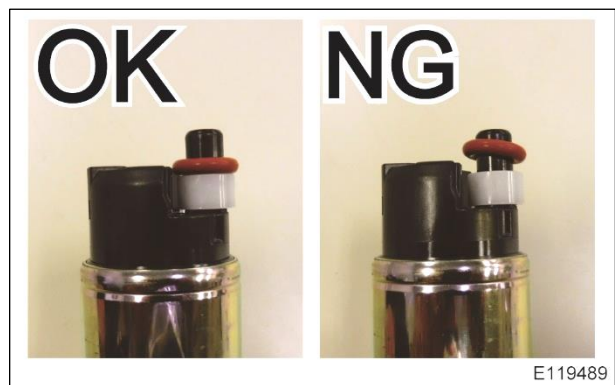
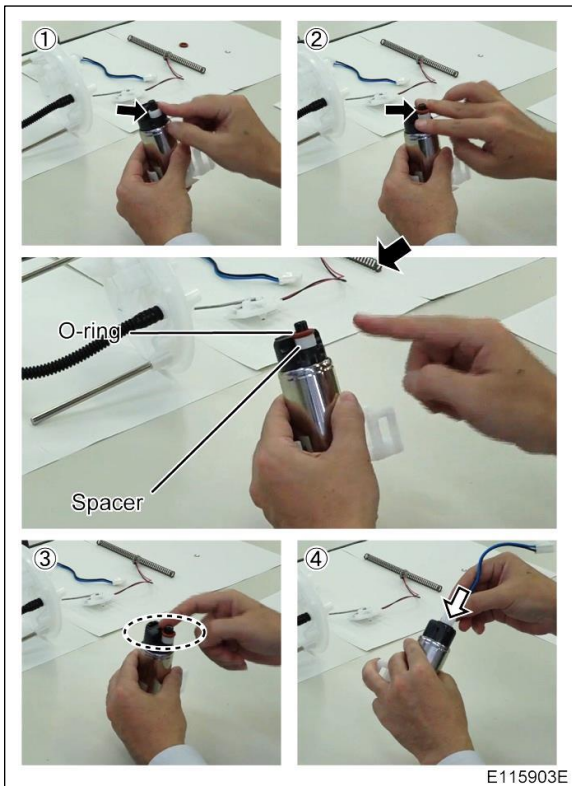

- Be careful as to the pushing location so that the suction filter is not broken. Use the palm of your hand to push in the entire surface of the suction filter straight forward.
- Be careful that the flange does not contact anything as damage will lead to a fuel leak.

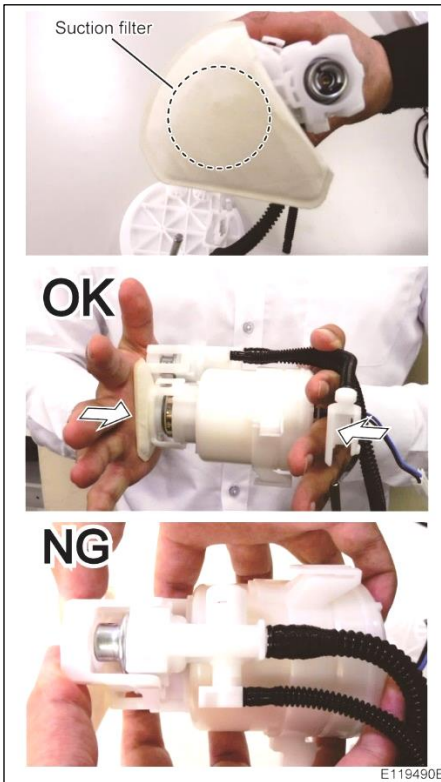

3. Install the fuel pump in the high-pressure pump.

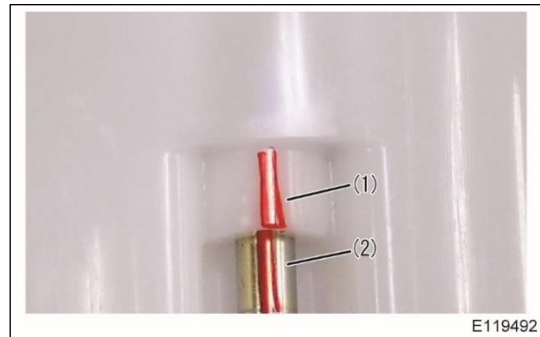
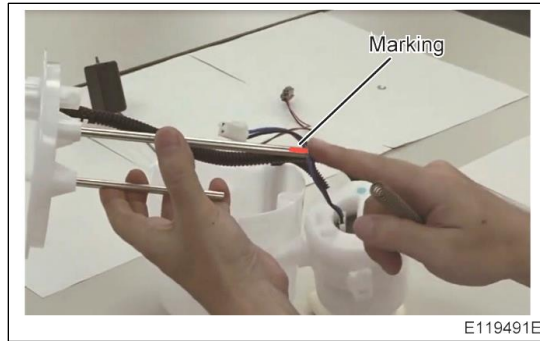
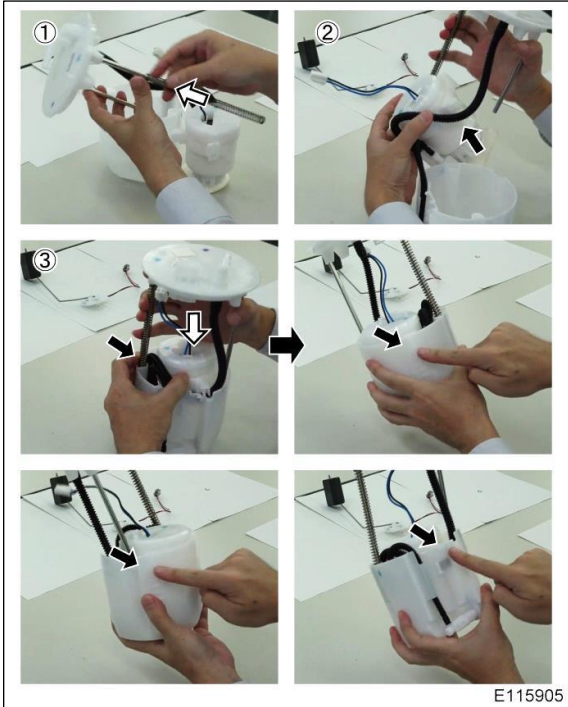

NOTE: Only 4WD that has fuel pump # PYY2 has transfer jet pump

Install the O-ring with the thin wire diameter on the transfer jet pump.

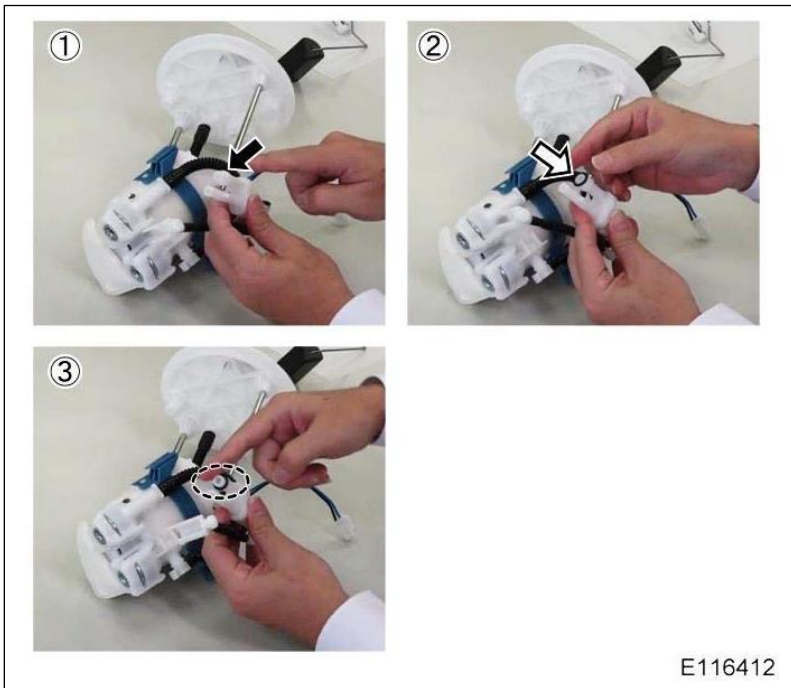

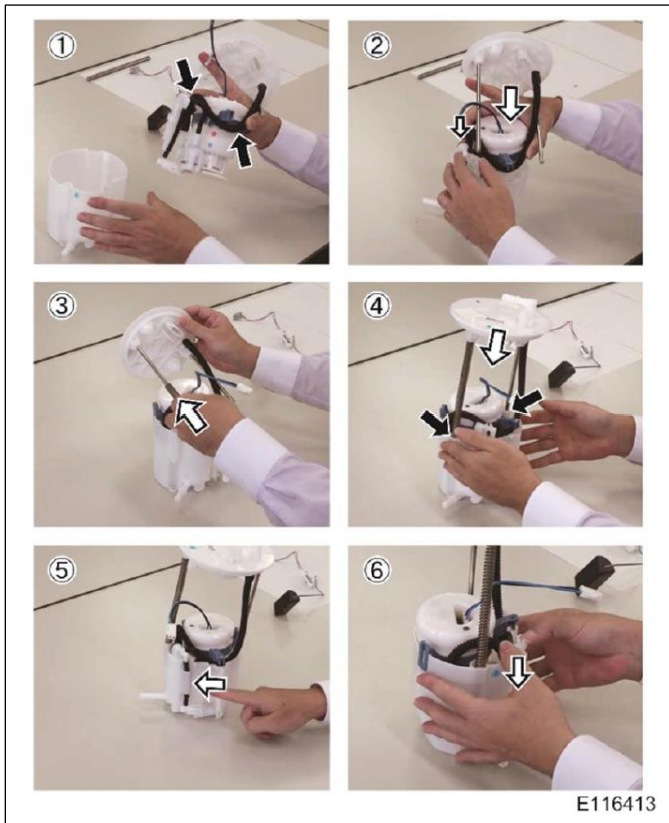

Install the strainer in the reservoir

- ① Set the fuel tube so that the routing is the same as was noted before disassembly.
- ② While placing the strainer in the reservoir, insert and provisionally install the transfer jet.
- ③ Insert the spring in the sliding shaft.
- ④ Insert the sliding shaft in the sliding opening of the reservoir.
- ⑤ Install the bellows tube of the jet pump on the guide part of the reservoir.
- ⑥ Install the transfer jet pump.
Align the joint part with the fitting position of reservoir, push on the upper surface of the jet pump, and push in until the joint part is below the guide part.

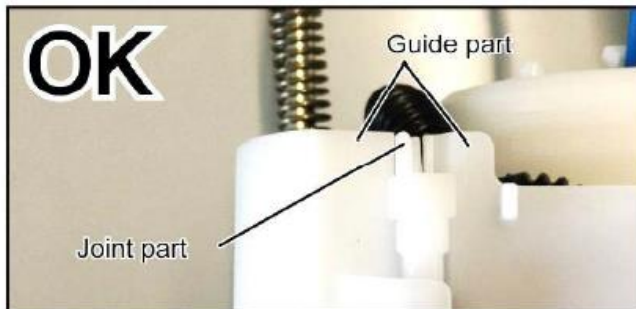

Check the joint part is in the correct position.

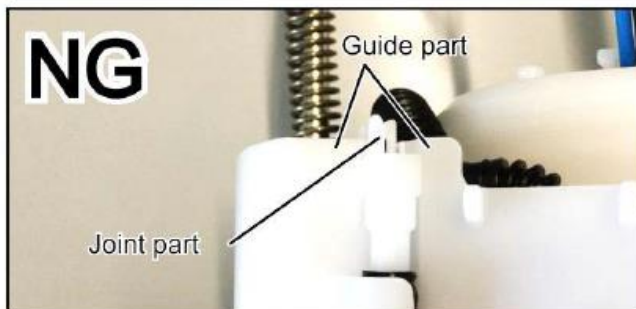

E116415E

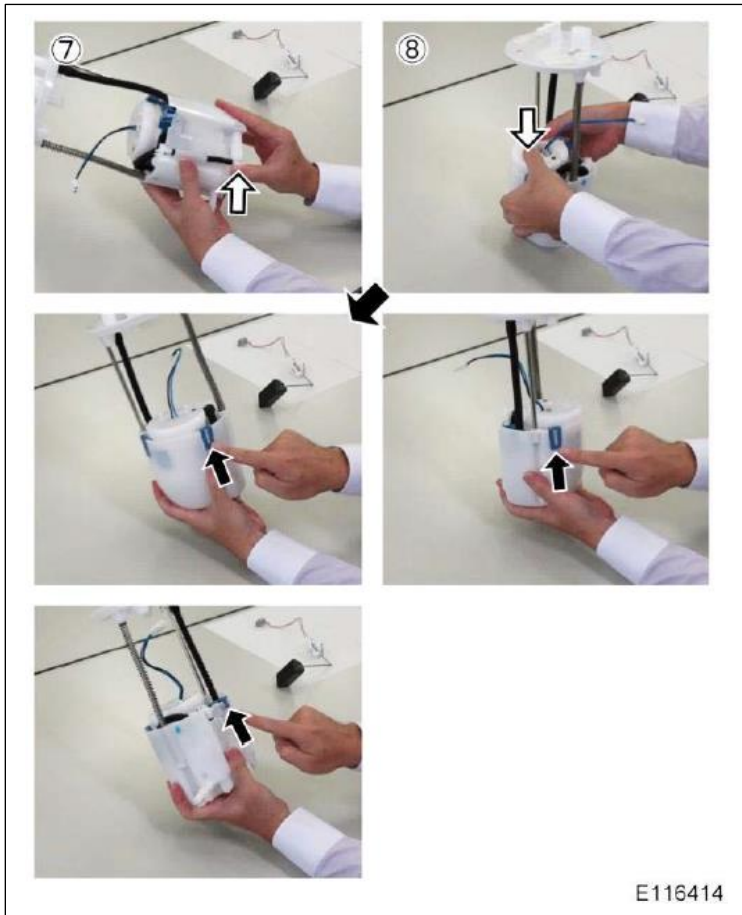

⑦ Install the jet pump on the reservoir.
Make sure that the lock has been checked and secure.

⑧ Push the strainer, and then make sure that the three joints have been installed correctly.

CAUTION:

Be careful when arranging the ground wire so it does not come out of the sliding shaft.

4. Install the new E-ring. Use needle-nose pliers or similar tool for installation.
Make sure the E-ring can rotate by a finger after installation

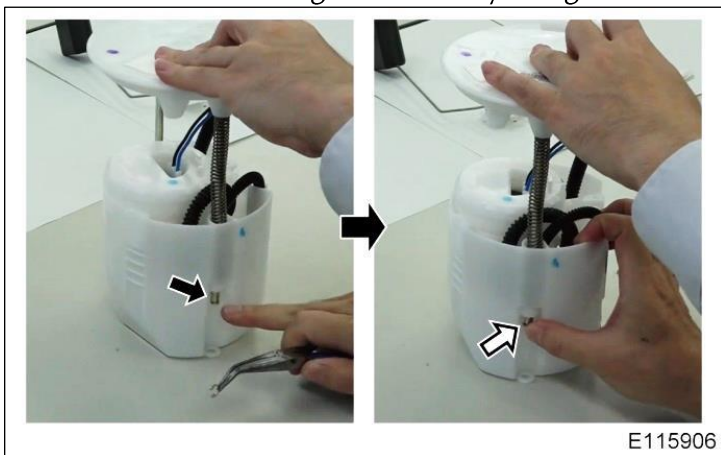

5. Install the fuel gauge sender in the reservoir cup.

CAUTION: Push the resin part in and down, while making sure not bend the arm of the fuel gauge sender, and do not touch resistance substrates or contacts to prevent fuel problems.

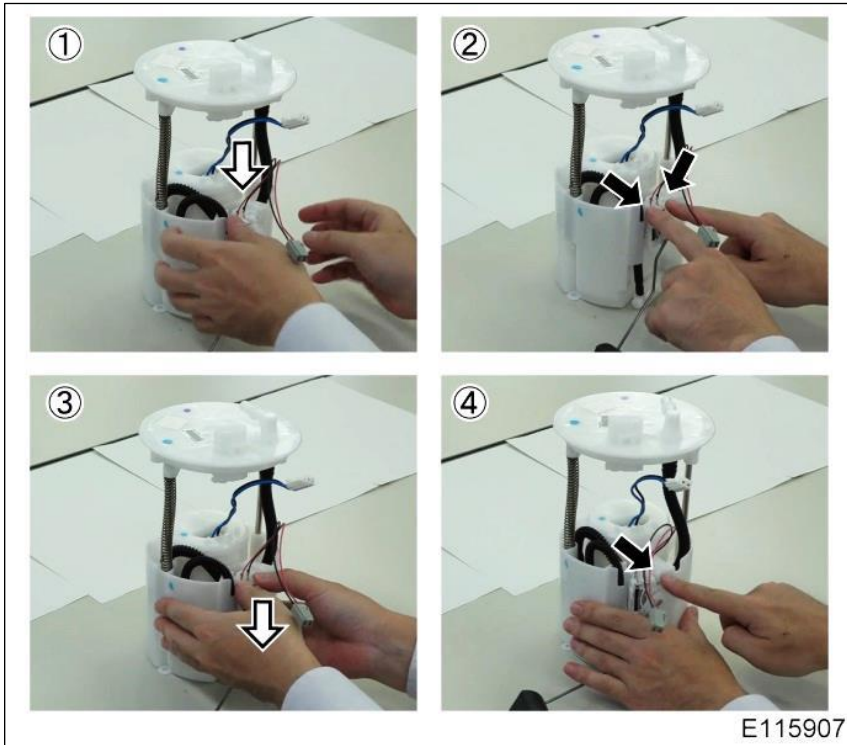

Make sure that the lock has been checked and secured.

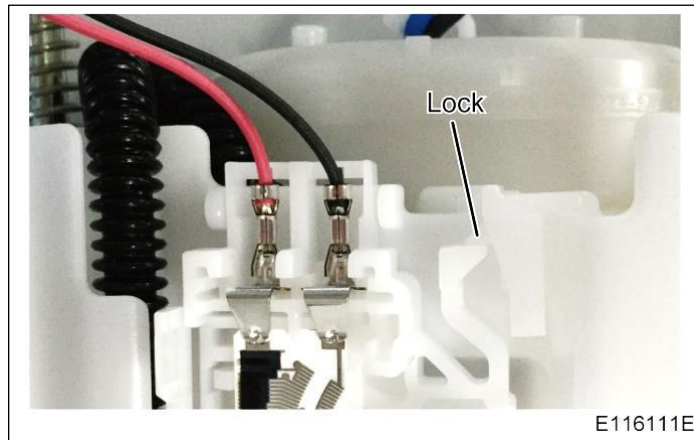
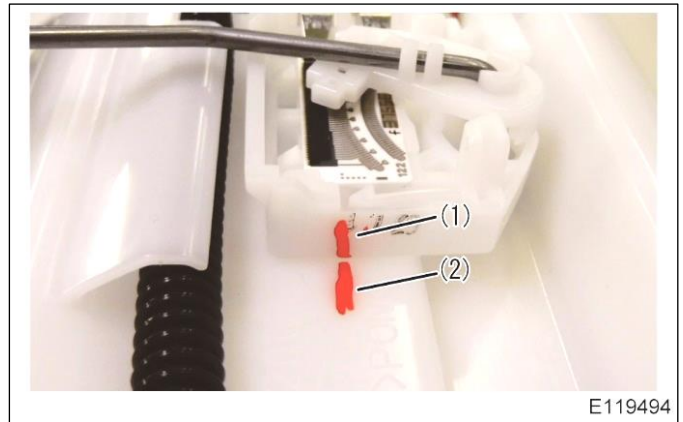
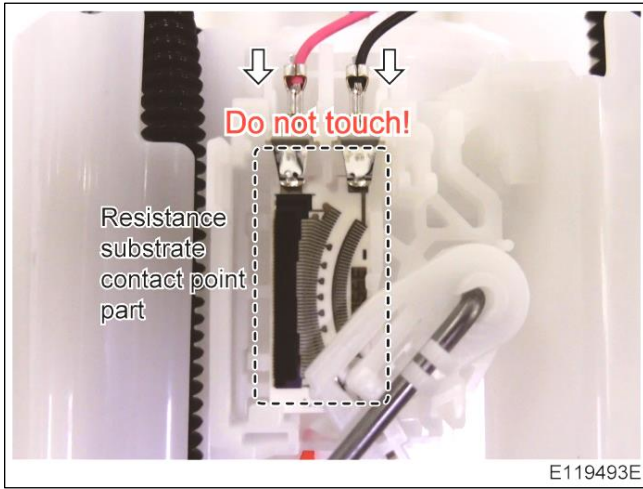

6. Install the connector of the wire harness. Make sure that the lock has been checked and is secure.



7. Install the wire harness in the clamp section. If the harness was damaged as shown in step 4, install the new harness at this time.

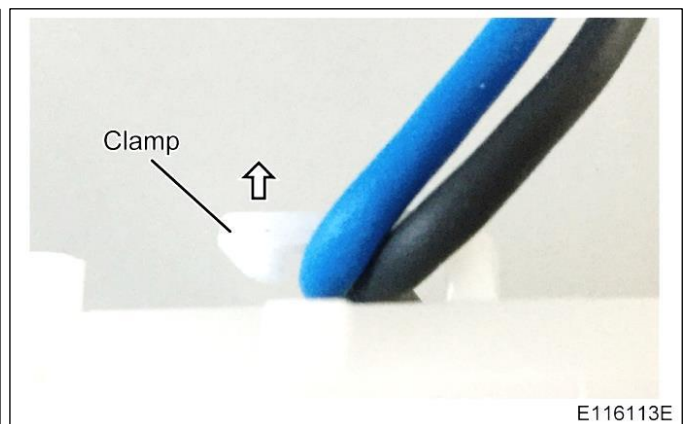
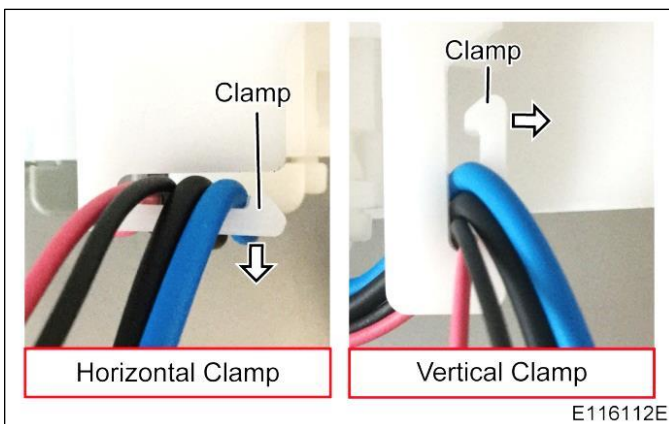
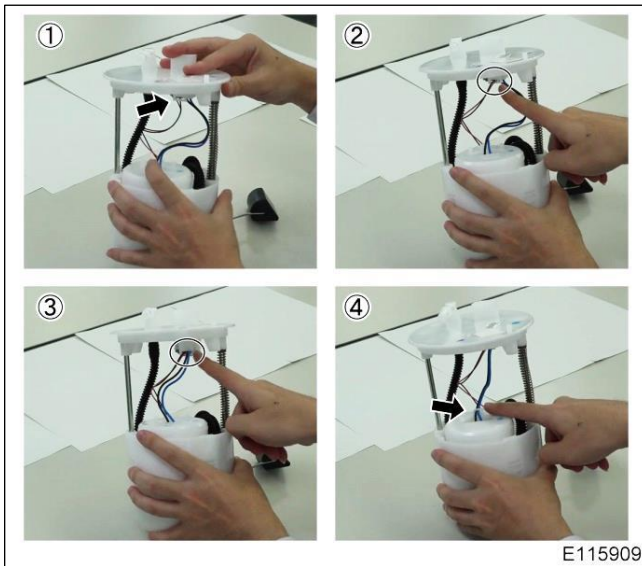

8. Install in the reverse order of removal.

CAUTION: Fuel Pump & Gauge (FDM) Unit Reassembly note:

- i. Fill the tank with the fuel you previously drained (if drained prior to repair).
- ii. Connect the battery (-) cable and start engine.
- iii. Make sure there are no fuel leaks near the fuel pump unit
- iv. Ensure all screws are properly fastened (models with screws). For CX-3 and Mazda2 check for any cracks in the fuel ring and do not overtighten.
- v. Drive the vehicle, go, and stop suddenly 5-6 times at low speed.
- vi. Stop the vehicle and check that there is no fuel leakage near the fuel pump and tank.
- vii. Perform an on-board evap test to confirm no evaporative leak with IDS

C. CAMPAIGN LABEL INSTALLATION

1. Fill out a yellow "Campaign Label" (9999-95-055A-06) with Campaign No: "5321K", your dealer code, today's date.

CAMPAIGN LABEL

CAMPAIGN NO: _____

DEALER CODE: _____

DATE: //

PIN 9999-95-055A-06

1329

2. Affix it to the hood as shown:

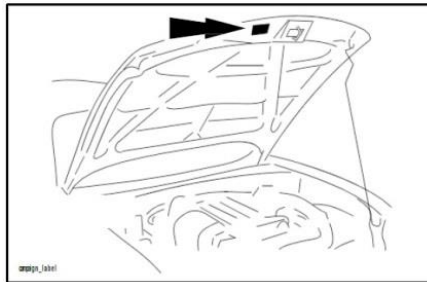

END OF REPAIR PROCEDURE