

TECHNICAL INSTRUCTIONS

SAFETY RECALL 21TA04

POTENTIAL INCREASED BRAKING DISTANCE

CERTAIN 2020 - 2021 MODEL YEAR SUPRA VEHICLES

The repair quality of covered vehicles is extremely important to Toyota. All dealership technicians performing this recall are required to successfully complete the most current version of the E-Learning course “Safety Recall and Service Campaign Essentials”. To ensure that all vehicles have the repair performed correctly; technicians performing this recall repair are required to currently have completed all of the following courses:

- TIN519B – GR Supra New Model Technical Introduction

Always check which technicians can perform the repair by logging on to <https://www.uotdealerreports.com>. It is the dealership’s responsibility to select technicians with the above certification level or greater to perform this repair. Carefully review your resources, the technician skill level, and ability before assigning technicians to this repair. It is important to consider technician days off and vacation schedules to ensure there are properly trained technicians available to perform this repair at all times.

I. OPERATION FLOW CHART

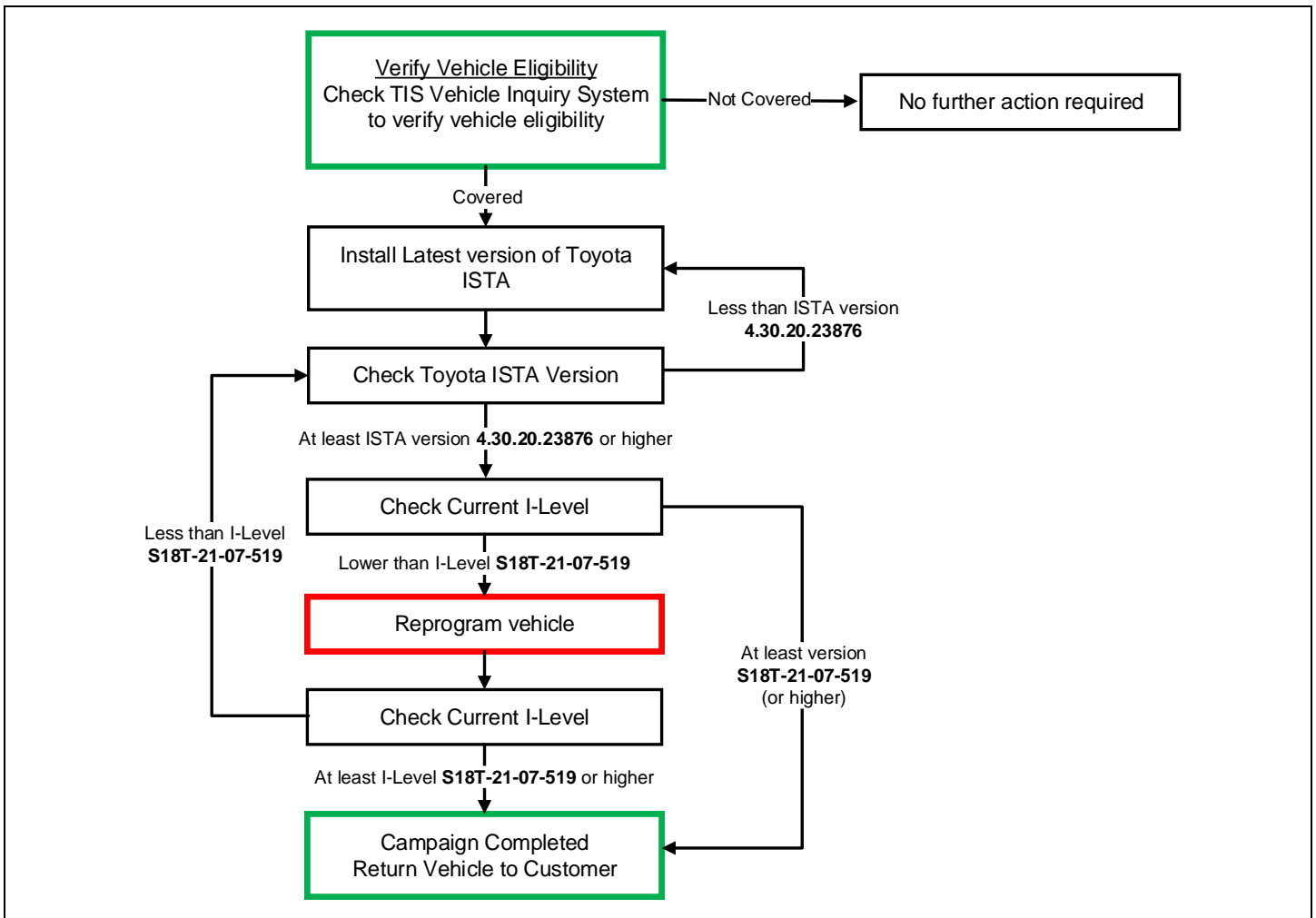

II. IDENTIFICATION OF AFFECTED VEHICLES

- Check the TIS Vehicle Inquiry System to confirm the VIN is involved in this Campaign, and that it has not already been completed prior to dealer shipment or by another dealer.
- TMS warranty will not reimburse dealers for repairs completed on vehicles that are not affected or were completed by another dealer.

III. BACKGROUND

The subject vehicles are manufactured by BMW. According to BMW, the subject vehicles have been equipped with an engine management software that, under certain specific engine start conditions, could damage a component that provides braking power assistance. In this condition, there could be a loss in the brake assist and an increase in stopping distance. This can lead to an increased risk of a crash.

IV. PREPERATION

A. TOOLS & EQUIPMENT

- Techstream ADVi (TSADVUNIT)
- Battery Diagnostic Tool (DCA-8000P)
- Toyota Supra Diagnostic Cable (01018-00118)

V. OVERVIEW OF WORK PROCEDURE (REPROGRAMMING USING ISTA)

Software inside the vehicle's computers are reprogrammed using Toyota ISTA. Reprogramming of ECUs via Toyota ISTA requires that the software version of all the vehicle ECUs to be unified; therefore, reprogramming is always carried out for all ECUs.

It is not possible to select a target ECU and then reprogram it individually. Always follow the directions of this document when carrying out reprogramming work in order to prevent any potential damage to the ECUs due to by communication errors, voltage drops, or other problems.

VI. WORK PROCEDURE TABLE OF CONTENTS

COMPONENTS.....	SECTION VII
INSTALL THE LATEST VERSION OF TOYOTA ISTA.....	SECTION VIII
CHECK ISTA LANGUAGE SETTINGS	SECTION IX
CHECK ISTA VERSION OF TECHSTREAM ADVi	SECTION X
ENSURE THAT VEHICLE HAS COMPLETED PRE-DELIVERY SERVICE	SECTION XI
PREPARE THE TECHSTREAM AVDi.....	SECTION XII
PREPARE THE VEHICLE	SECTION XIII
CONNECT THE BATTERY CHARGER.....	SECTION XIV
CONNECT THE TECHSTREAM ADVi TO THE VEHICLE	SECTION XV
CHECK THE I-LEVEL	SECTION XVI
PERFORM THE REPROGRAMMING (UPDATE I-LEVEL)	SECTION XIII
DISCONNECT TOYOTA ISTA.....	SECTION XVII
PLACE VEHICLE IN SLEEP MODE FOR 15 MINUTES	SECTION XIX

VII. COMPONENTS

ENGINE CONTROL COMPUTER
UPDATE THE I-LEVEL TO: **S18T-21-07-519**
(OR GREATER)

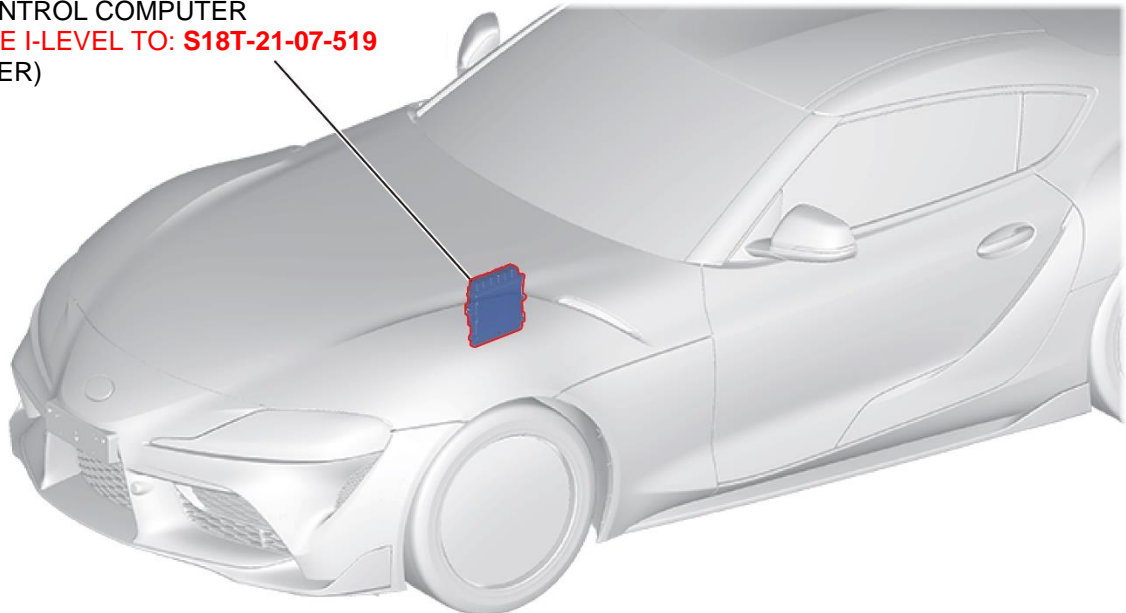

R2107060005a

VIII. INSTALL THE LATEST VERSION OF TOYOTA ISTA

A. INSTALL THE LATEST VERSION OF TOYOTA ISTA

1. It is **CRITICAL** to install the latest version of Toyota ISTA on the Techstream ADVi. Your current ISTA version may not be sufficient for this campaign.

Minimum* ISTA Version Required for this Campaign: 4.30.20.23876

*Versions of ISTA higher than 4.30.20.23876 are also acceptable. As a best practice you should always download the latest version of ISTA before performing this campaign.

2. Access this URL for instructions on how to download the latest version of ISTA:
[Toyota ISTA Installation Instructions](#)

IX. CHECK ISTA LANGUAGE SETTINGS

A. CHECK ISTA LANGUAGE SETTINGS

1. The screenshots in this document were developed using ISTA software configured for “American English”.
2. It is recommended that you ensure your ISTA is configured for “American English” (rather than “British English”) so that the screenshots match your screen.

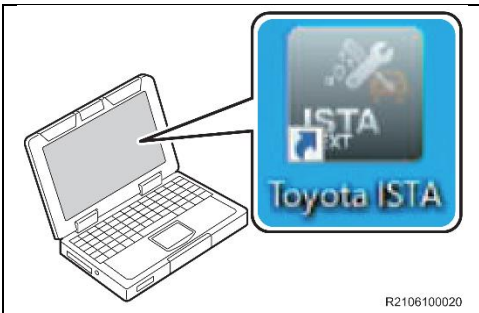

3. Double-click the icon to start Toyota ISTA.

Note: After double-clicking, it takes about 15 seconds for Toyota ISTA to start. Please wait without double-clicking again.

4. The following screen appears. Click “Accept”.

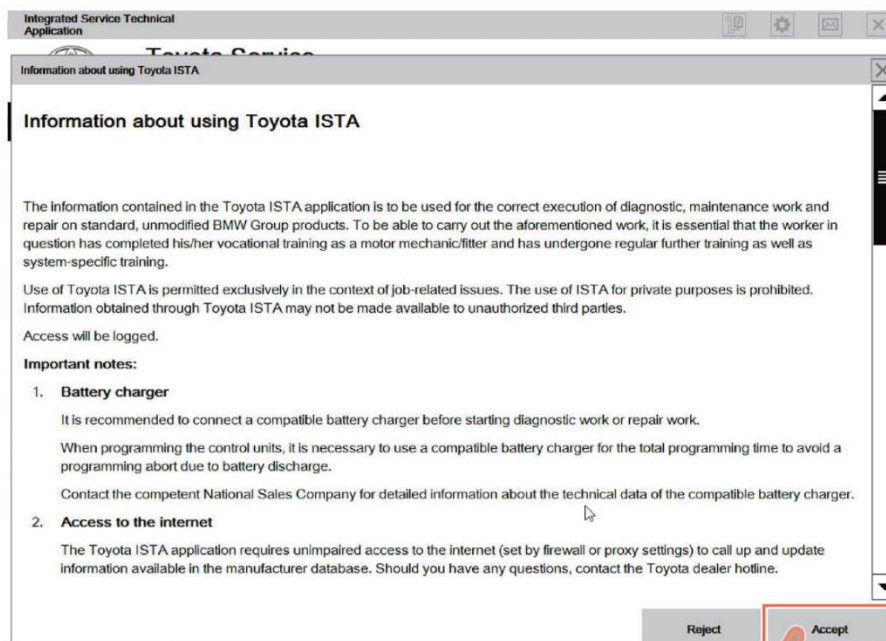

5. Click on the Configuration Button as indicated in the illustration.
6. Click on the Client settings tab as indicated in the illustration.
7. Select “American English”
8. Click “OK”

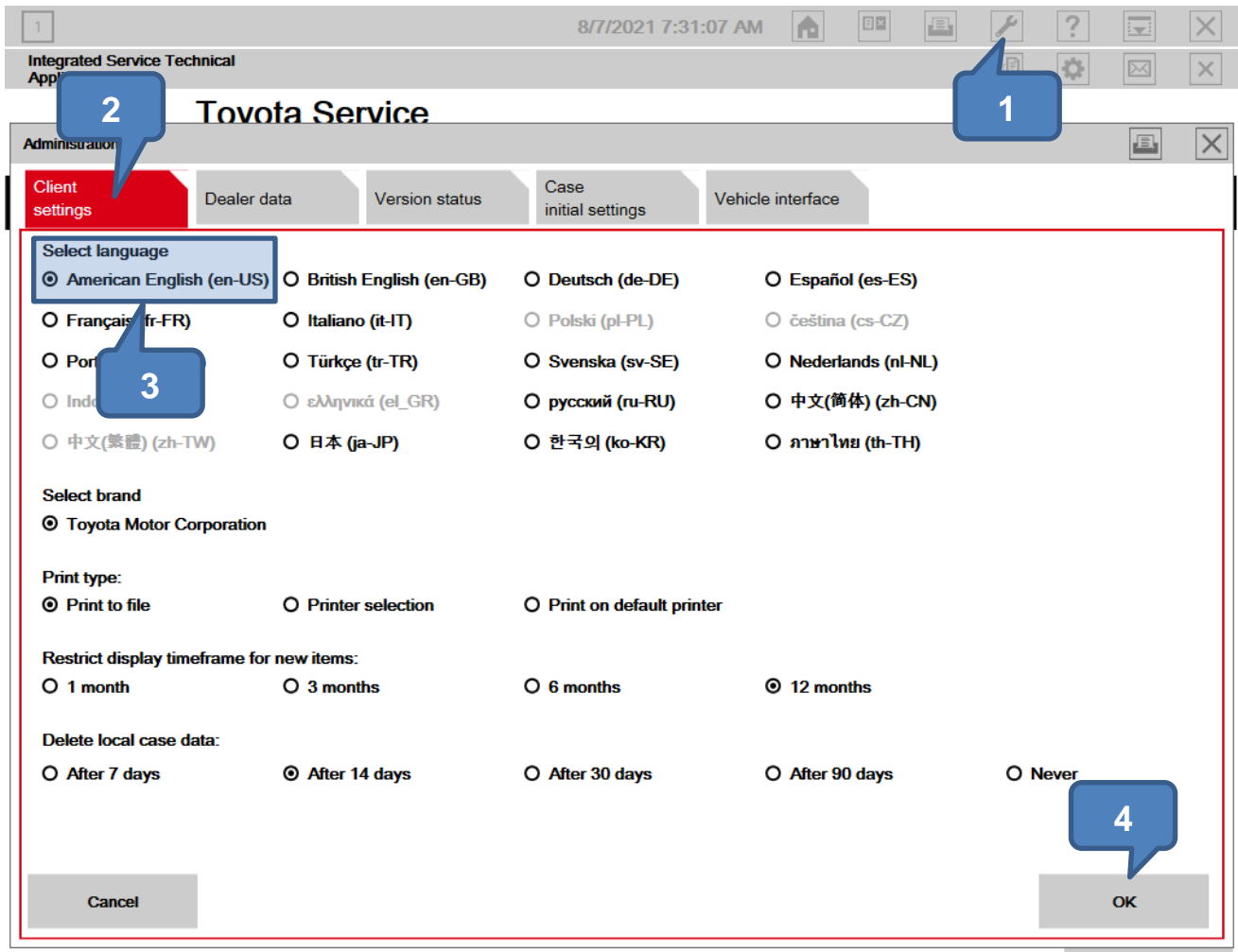

9. ISTA may require a restart for the language change to take effect.

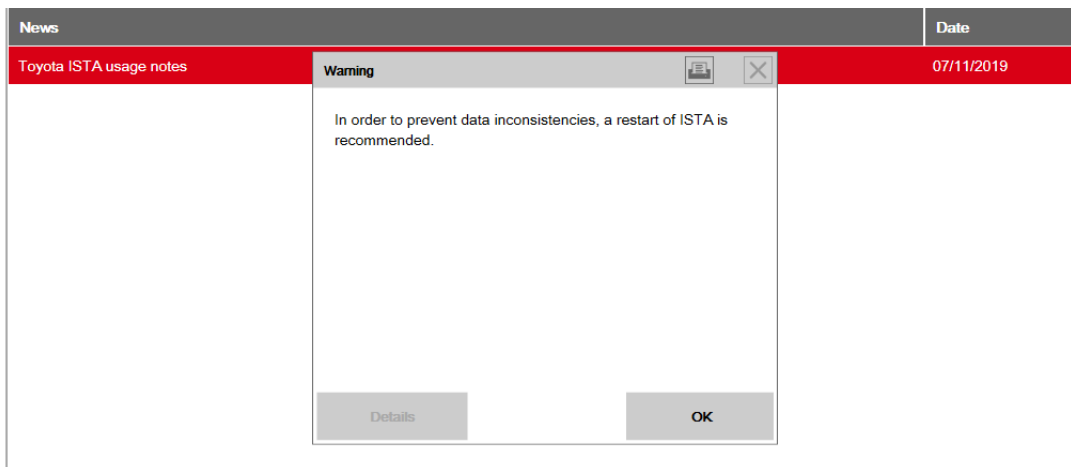

X. CHECK ISTA VERSION OF TECHSTREAM ADVi

A. CHECK ISTA VERSION OF TECHSTREAM ADVi

1. Its **CRITICAL** to confirm that the ISTA version installed on your Techstream ADVi meets or exceeds version 4.30.20.23876 before proceeding. Your current ISTA version may not be sufficient for this campaign.



2. Double-click the icon to start Toyota ISTA.
Note: After double-clicking, it takes about 15 seconds for Toyota ISTA to start. Please wait without double-clicking again.

3. The following screen appears. Click "Accept".

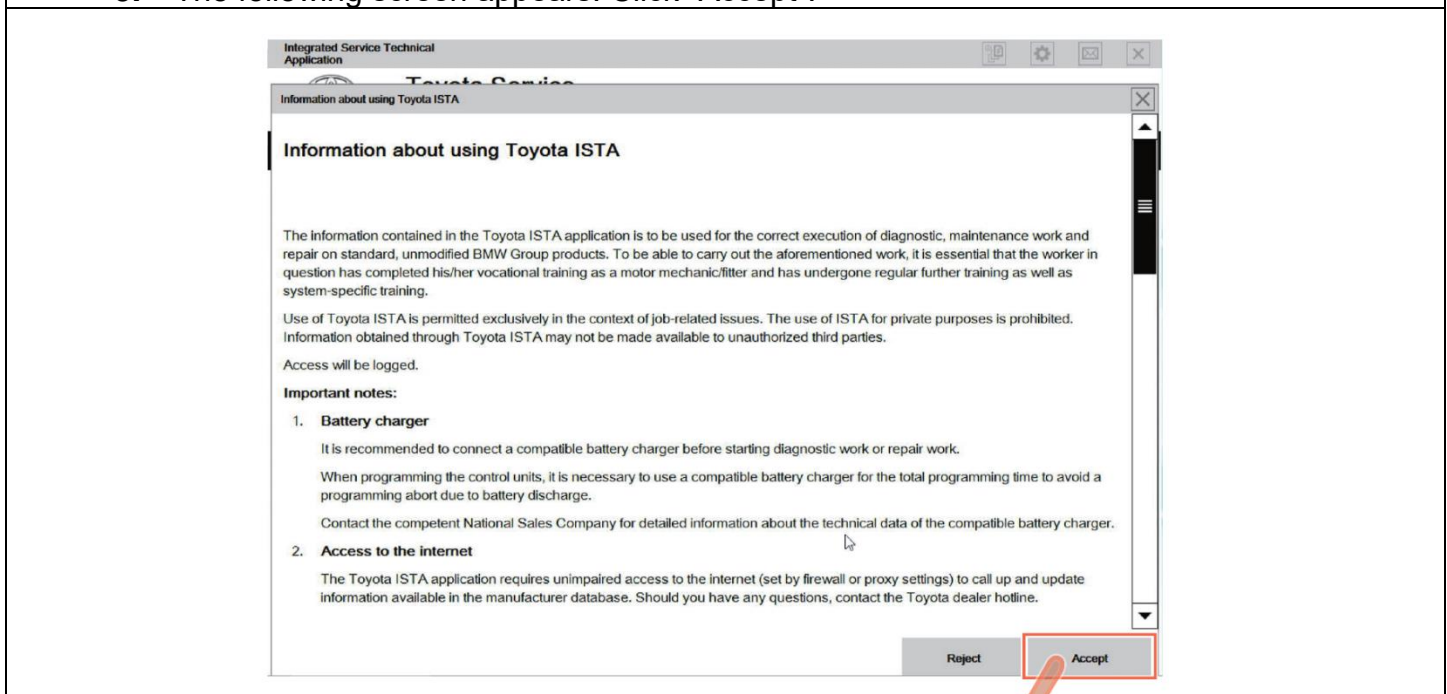

R2106100021

4. Click on the Configuration Button as indicated in the illustration.
5. Click on the Version status tab as indicated in the illustration.
6. Compare the installed version to the minimum required version: **4.30.20.23876**. If the version is less than version **4.30.20.23876**, install the latest version.

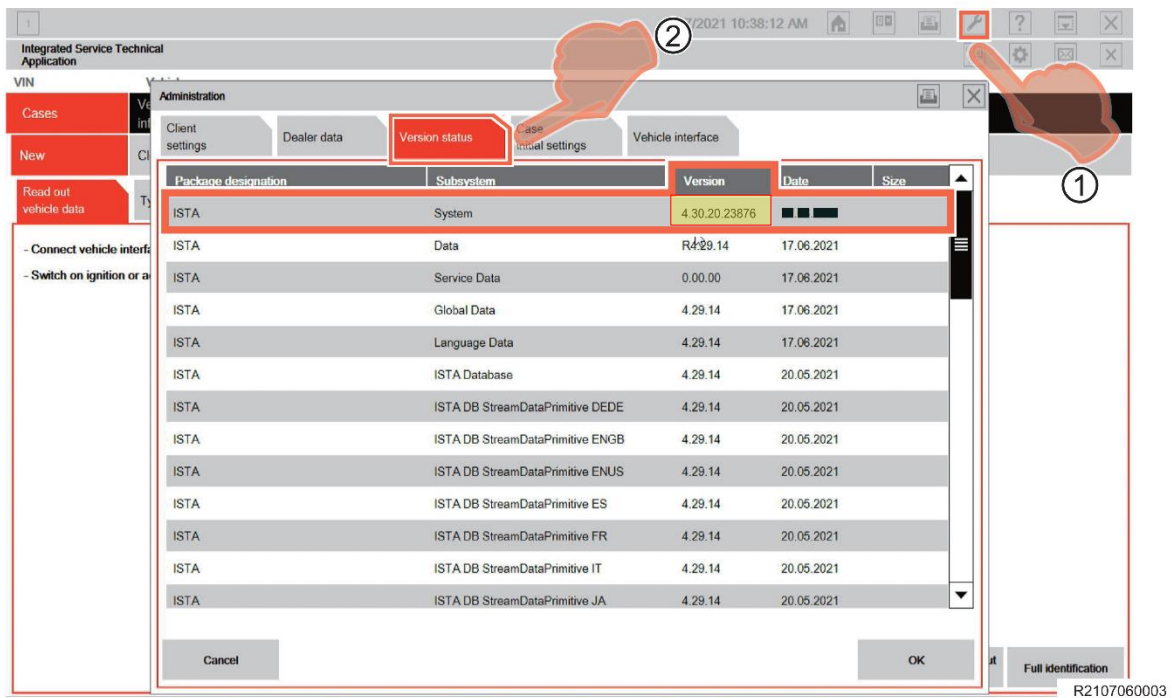

XI. ENSURE THAT VEHICLE HAS COMPLETED PRE-DELIVERY SERVICE

Make sure that Pre-delivery Service has been completed before this reprogramming. If Pre-delivery service has not been completed before this reprogramming, the reprogramming may not be completed correctly. Refer to [T-SB-0083-19](#) (2020 model year Supra) or [T-SB-0038-20](#) (2021 model year Supra) for Pre-delivery technical instructions.

XII. PREPARE THE TECHSTREAM AVDi



1. Ensure the Techstream software is installed, registered, and up to date
2. Complete all pending Windows updates.
3. Disable any automatic Windows updates and configure antivirus software so that it doesn't automatically run.
4. Disable all automatic screen savers.
5. Disable "sleep mode" within windows power settings.
6. Close all other applications.
7. Attach the Techstream AVDi directly to an AC Power Supply.
8. **DO NOT** perform any other functions while Toyota ISTA is reprogramming.

XIII. PREPARE THE VEHICLE

A. PREPARE THE VEHICLE

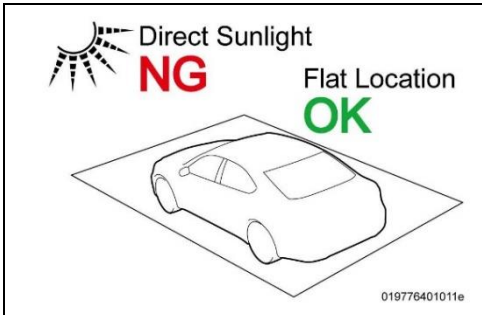
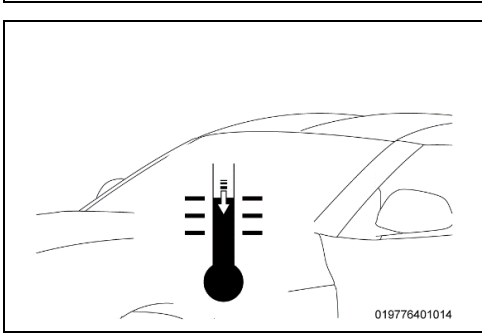
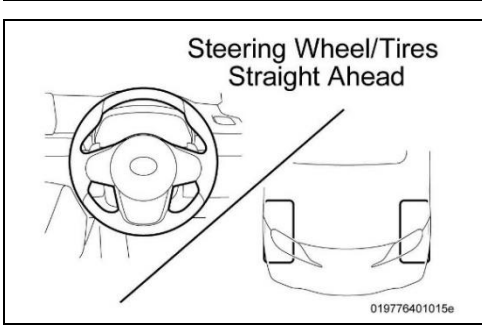
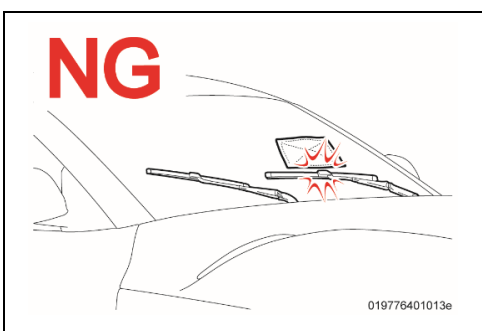

During reprogramming, each system (lights, mirrors, seats, windows, etc.) will be operated automatically for initialization. If operation is obstructed, a fault code is recorded, and the initialization may not finish normally. To prevent this, follow each instruction displayed on the screen while carrying out work.

	<ol style="list-style-type: none">1. Before working, make sure the vehicle is parked in a flat location that is not subject to direct sunlight.
	<ol style="list-style-type: none">2. The ambient temperature has to be higher than 59° F.3. Allow the temperatures of the engine, transmission, and brake system to fall to the ambient temperature.
	<ol style="list-style-type: none">4. Set the steering wheel and tires straight ahead position.
	<ol style="list-style-type: none">5. DO NOT place anything on the windshield so that the wiper can work normally, because the wiper may move automatically during reprogramming for initialization.

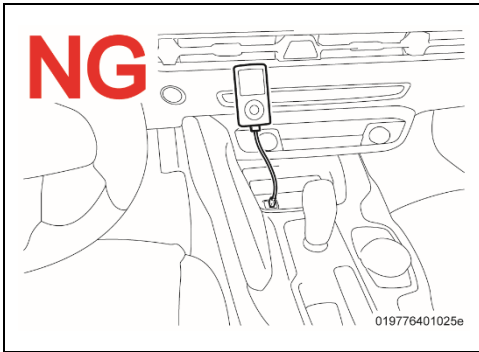

6. Remove all the inserted and connected data carriers from the vehicle and disconnect the data connections (e.g. Bluetooth paired mobile phones), so they **DO NOT** interrupt programming by communication or connection.

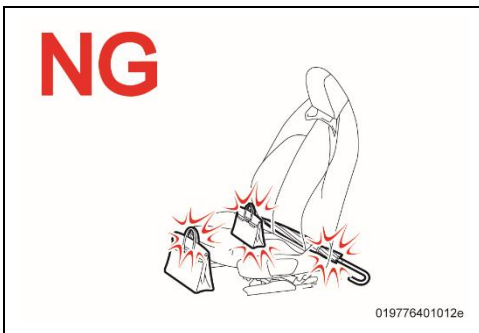

7. **DO NOT** place anything on, in front of, or behind the front seats because the front seats move automatically during reprogramming for initialization.

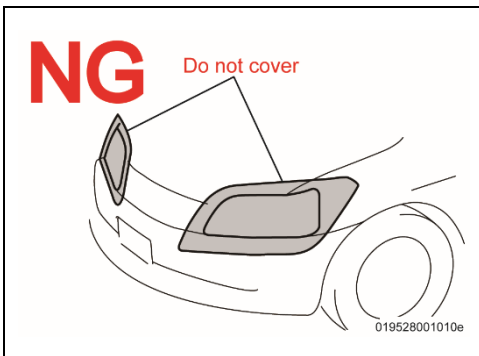

8. **DO NOT** cover the headlights with protective covers, because temperatures may rise, and the headlights may be deformed or damaged.

9. Set the shift lever to “P” , and then engage the parking brake.

10. Turn off the engine, and set all of the switches of the electrical components to off.

11. Close all doors and the back door, the hood must remain open as the battery charger will need to be connected to the charging terminals during the reprogramming process.

XIV. CONNECT THE BATTERY CHARGER

A. CONNECT A BATTERY CHARGER

1. Connect the specified battery charger at the locations in the illustration.

Battery Charger	Mode	Voltage	Battery Type
DCA-8000	Power Supply Mode	13.5-14.6	AGM

Before starting the reprogramming procedure, please make sure you have connected the DCA-8000 battery charger. The usage of a charger during the ECU Software update process is mandatory.

During this reprogramming the headlights will turn on, and the seats and other electrical components will function. To prevent damage to the ECU's, due to flat battery or voltage drop, ALWAYS connect the specified battery charger.



- Unlike other Toyota vehicles, the Toyota Supra is capable of drawing high amperage (a peak of 70 Amps flows at maximum) during diagnosis and repair. The Toyota Supra is equipped with an AGM type battery, discharges will affect the life span of the battery. AGM batteries must not have a charging voltage that exceeds 14.6 volts.
- Always connect the power supply of the battery charger to an outlet directly. If a power strip or other device is used, and multiple electrical components are connected, the battery charger may detect a power supply error due to insufficient current, and it may not be possible to charge the battery.
- Make sure that the battery charger is off before connecting it.
- Make sure you respect the correct polarity when connecting the battery charger cables like displayed in the illustration below.
- **DO NOT** disconnect the battery charger during reprogramming work.
- Observe the instructions of the battery charger manual, and check the dealership electrical system to ensure the circuit of the outlet to be used can operate the battery charger.

Connect Battery Charger

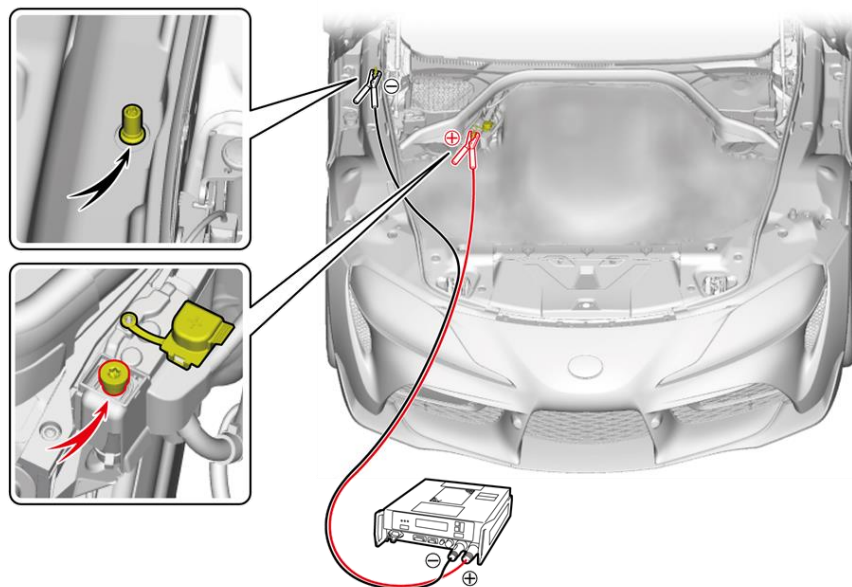

019776401007e

XV. CONNECT THE TECHSTREAM ADVi TO THE VEHICLE



NOTICE: It is an absolute necessity that the vehicle is connected to the Techstream ADVi via the Toyota Supra Diagnostic Cable which has a LAN ethernet connection.

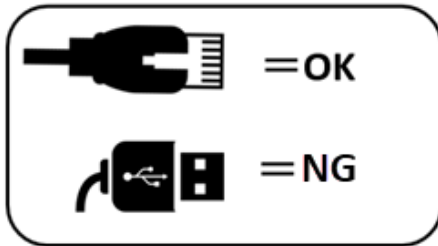

In order to maintain successful communication between the Techstream ADVi and the vehicle, the Toyota Supra Diagnostic cable must be used. Other interfaces that connect to the Techstream ADVi via USB are not allowed. Attempting to use such other devices may cause permanent ECU damage due to the slower communication speed.

A. CONNECT THE CABLE (connection sequence):

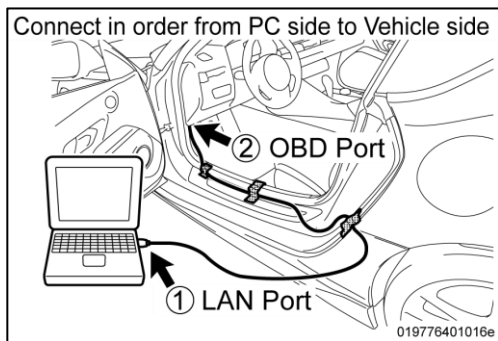

1. Always connect the Supra diagnostic cable **first** to your PC LAN port (1) and only after that to the OBD port of the vehicle (2).

If this order of operations is not respected, possible vehicle communication issues may occur when using Toyota ISTA software.

B. POSITION THE CABLE

1. Position the SUPRA diagnostic cable out of the vehicle as shown in the illustration. Otherwise the SUPRA diagnostic cable may be pinched, communication disconnected, and ECU's permanently damaged.
2. The Toyota Supra Diagnostic cable should always be passed through the position shown in the figure below. If it passes through any other position it is possible that the cable will be damaged.
3. Using the gap between the rear fender and the side garnish, pull the Supra Diagnostic cable to the outside of the vehicle. Please use protective tape for fixation and protection of the cable.

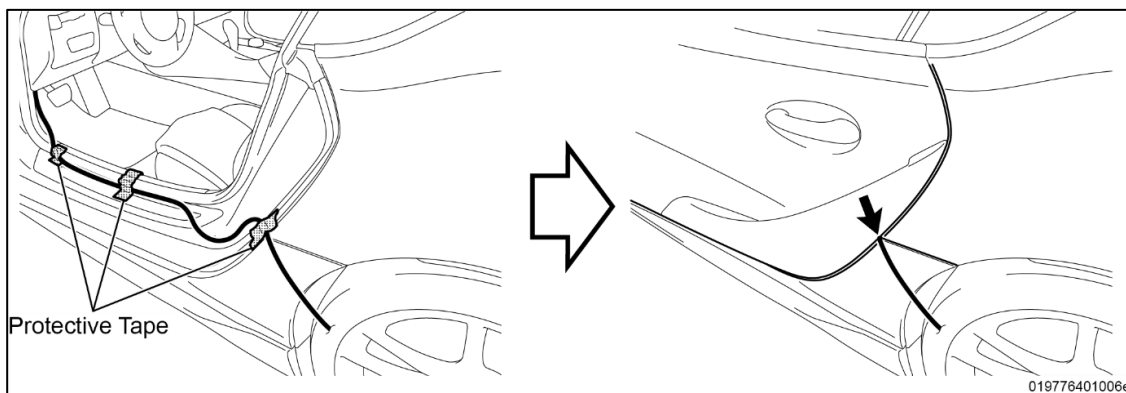

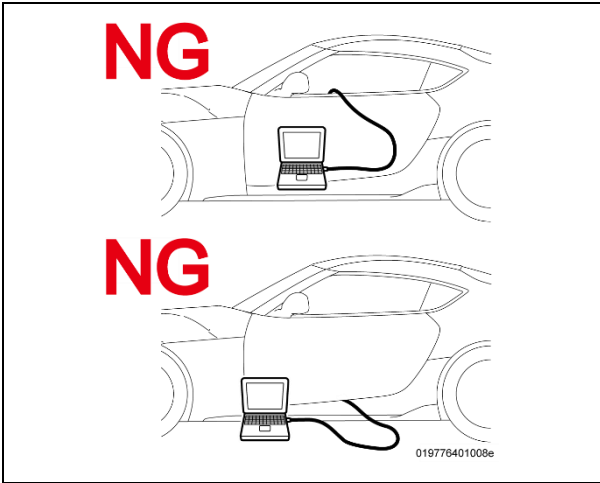

Note:

- **DO NOT** attempt to pass the ISTA diagnostic cable through the window opening. The window glass may move during reprogramming or initialization.
- Ensure the cable is out of the path of the front Driver's seat. During initialization the driver's seat moves and could damage cable or disconnect the OBDII connector during movement.
- Additionally, **DO NOT** attempt to pass the ISTA diagnostic cable through any other position of the door opening as it may cause damage to the cable.

XVI. CHECK THE I-LEVEL

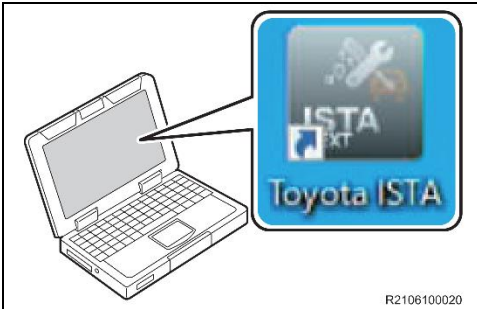

A. START TOYOTA ISTA

1. Double-click the icon to start Toyota ISTA.

Note: After double-clicking, it takes about 15 seconds for Toyota ISTA to start.
Please wait without double-clicking again.

2. The following screen appears. Click “Accept”.

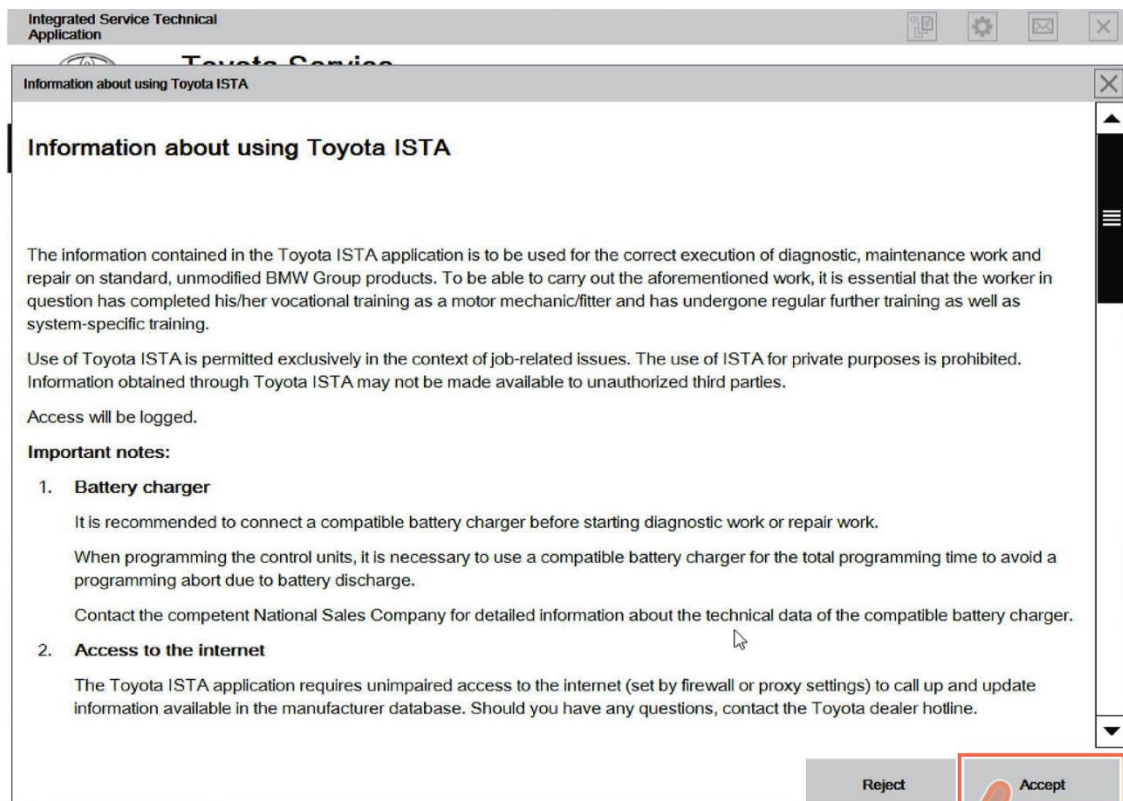

3. Double-click the operations bar to maximize screen and make the toolbar visible.

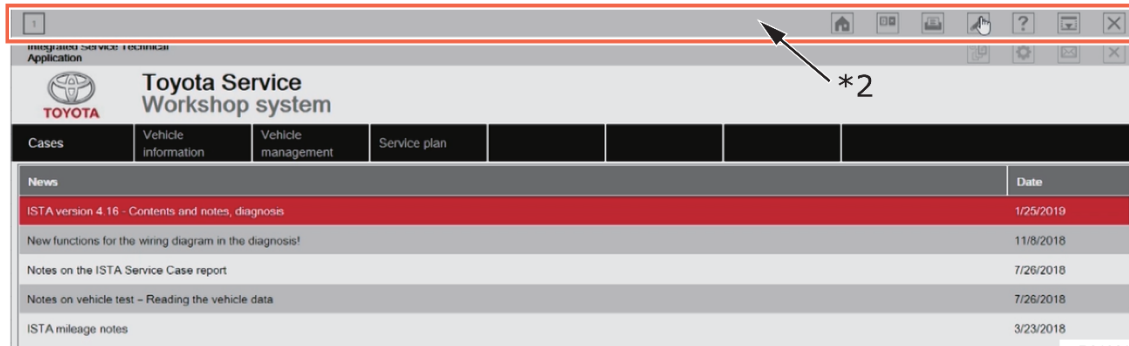
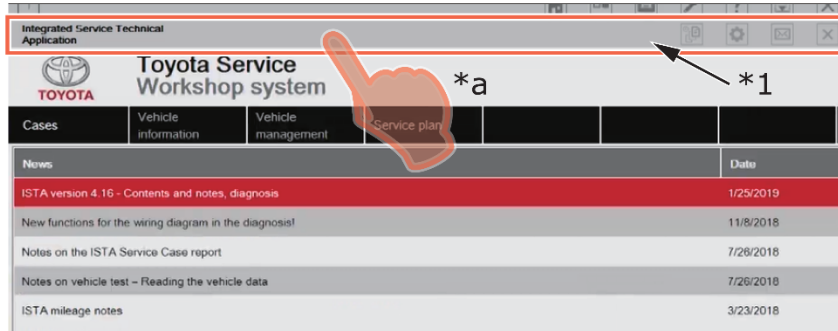

R2106100023

Pressing the Start Button
3 times in under 0.8s

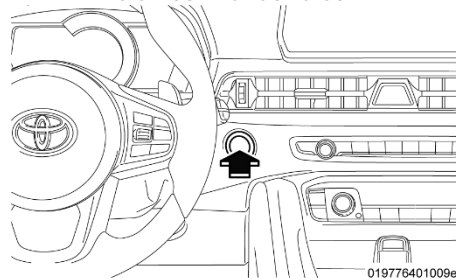

019776401009e

B. ACTIVATE PAD MODE

1. PAD mode can be activated by pressing the start button 3 times in under 0.8 seconds (very fast, foot off the brake pedal) or by directly connecting the Toyota ISTA software and initiating the vehicle connection.



While the vehicle is in PAD mode all energy monitoring logic will be disabled. The technician must utilize a battery charger to maintain sufficient current during all diagnosis and programming activities. If the battery charger is not connected battery life will be affected and ECU damage could occur.

Note: Ensure the pre-delivery service has already been completed on the vehicle. Part of pre-delivery service involves switching of “transportation mode”, which is required before proceeding with this remedy procedure.

NG Do not Open and Close



019776401024e



DO NOT open or close the driver's door during the programming routine. Perform only the vehicle operations indicated on the Toyota ISTA screen.

B. NAVIGATE TO I-LEVEL CHECK SCREEN

1. From Toyota ISTA home screen, click “Cases”-> “New” -> “Read out vehicle data”.
2. At the bottom right of the screen, click “Full identification”.

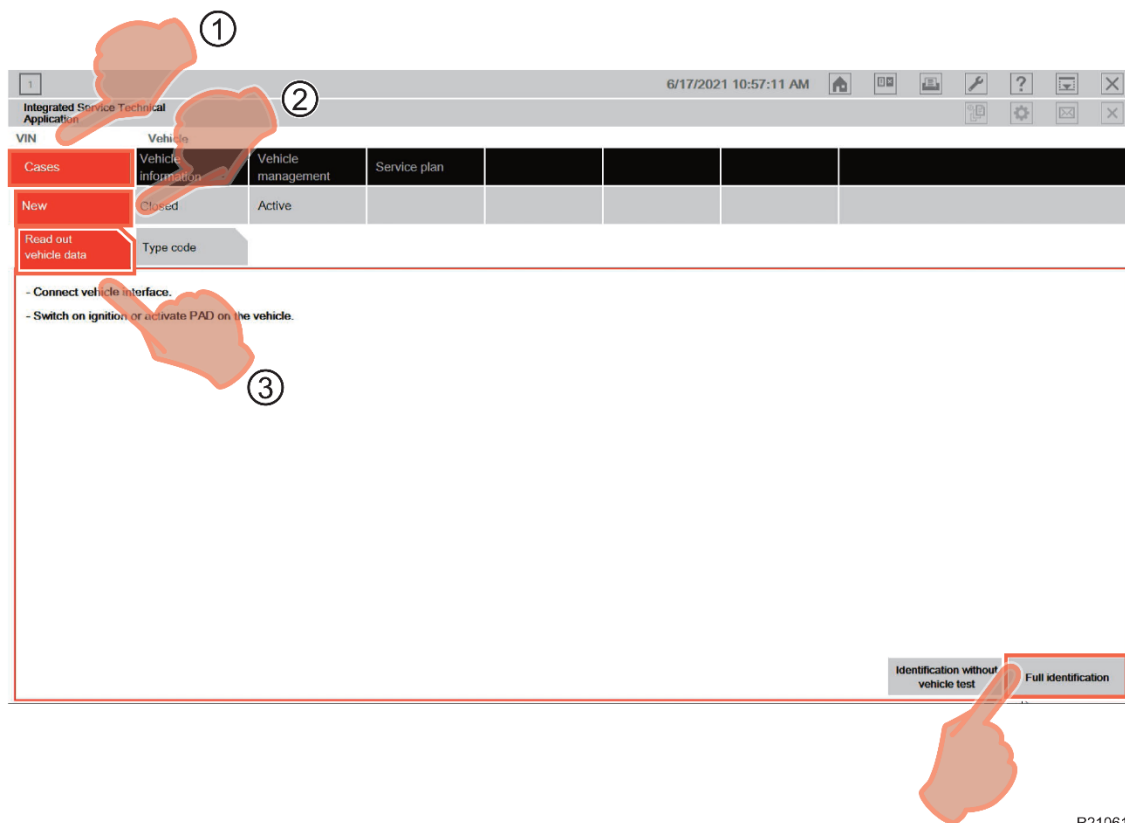

R2106100025

3. At the “Connection manager” screen, select the vehicle identification number, and then click “Establish connection”.

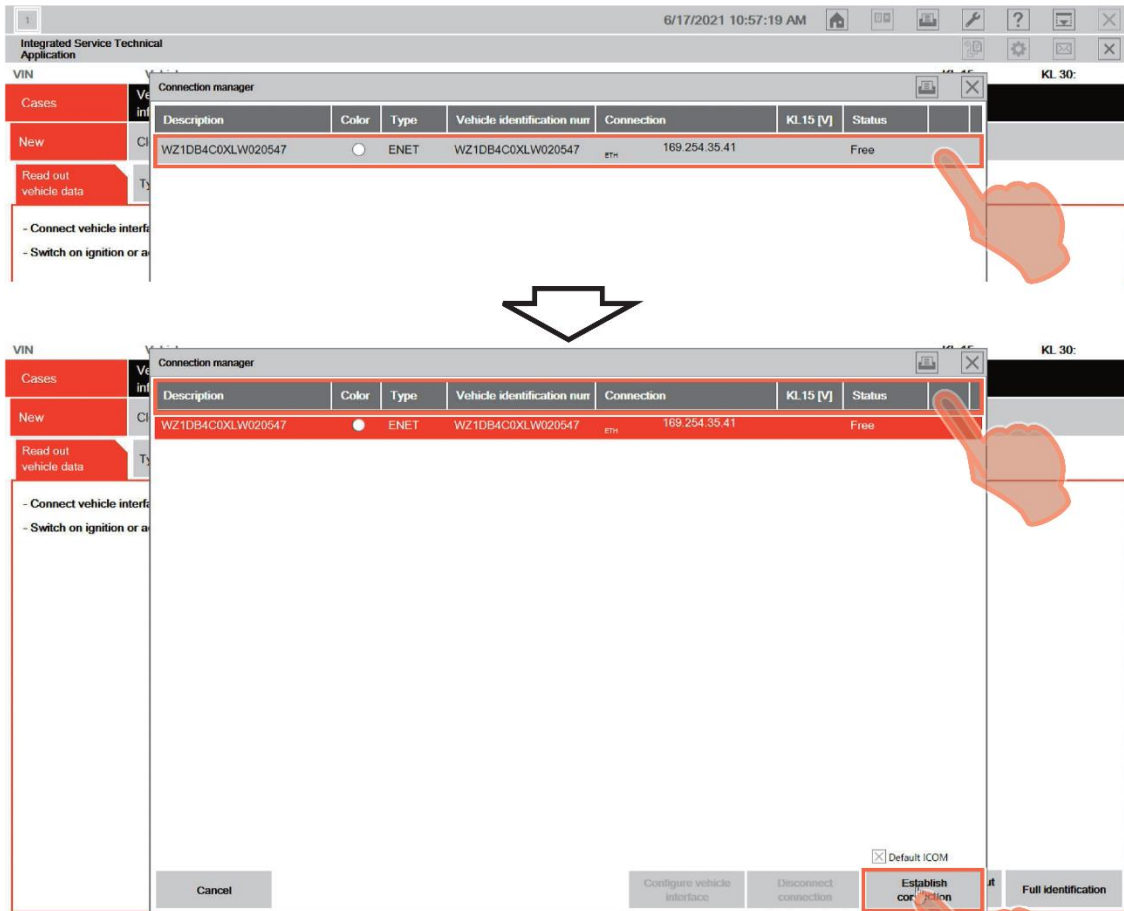

R2106100026

4. "Background process is being carried out" is started automatically.

The screenshot shows the 'Integrated Service Technical Application' interface. The top navigation bar includes 'Cases', 'Vehicle information', 'Vehicle management', 'Service plan', and 'Service Case report'. The 'Vehicle information' tab is active, displaying various vehicle details such as 'Vehicle ID no.', 'Model series', 'Engine', and 'Production date'. A dialog box titled 'Background process is being carried out' is overlaid on the screen, with a sub-header 'Vehicle identification (Read VIN)' and an empty input field. The dialog box has a close button (X) in the top right corner. At the bottom of the application window, there are buttons for 'Display action plan', 'Start vehicle test', and 'Search information'. The date and time in the top right corner are '6/17/2021 10:57:33 AM'. The reference code 'R2106100037' is visible in the bottom right corner.

Note: If the following "Information" dialog box is displayed, click "OK" to continue.

The screenshot shows the 'Integrated Service Technical Application' interface for a different vehicle. The top navigation bar is the same as in the previous screenshot. The 'Vehicle information' tab is active, displaying details for a 'TOYOTA/J29/Coupe/ - /B58, /AUT/US/left-hand drive/2019/03'. An 'Information' dialog box is displayed in the center, containing the following text: '10:39:47: The battery voltage detected of 14.389V is within the permitted range of 12.55V to 14.85V. Please connect the approved battery charger and use for the entire session. Otherwise the vehicle may be damaged.' The dialog box has 'Details' and 'OK' buttons at the bottom. A hand icon is pointing to the 'OK' button. The 'OK' button is highlighted with a red box. At the bottom of the application window, there are buttons for 'Display action plan', 'Start vehicle test', and 'Search information'. The date and time in the top right corner are '6/17/2021 10:39:48 AM'. The reference code 'R2106180001' is visible in the bottom right corner.

5. After clicking "OK", "Background process is being carried out" continues.

Integrated Service Technical Application
 6/17/2021 10:40:00 AM

VIN W020547 Vehicle TOYOTA/J29/Coupe/ - /B58,-/AUT/US/left-hand drive/2019/03 KL 15: -- KL 30: --

Cases Vehicle information Vehicle management Service plan

Vehicle details Vehicle equipment Control unit tree Control unit list Service Case report

Vehicle ID no. WZ1DB4C0XLW020547
 Odometer reading: 1686
 Drive type: REAR WHEEL
 Production date: 3/1/2019
 Body: Coupe
 First registration: -
 Basic version: US
 Technical Campaigns: -
 Status: Special defect code Title

Model series: -
 Engine: B58
 Engine identification: B58B30M1
 Model Year: 2019 / 03
 Steering: left-hand drive
 Engine number: -
 Upholstery code: MARS
 Development code: J29
 Electrical drive unit: -
 E-drive unit designation: -
 Paint code: 0A06

Sales designation: -
 Transmission: AUT
 HMI Version: ID5_2003
 Current I level: S18T-20-11-530
 Last programmed with: -
 Programming data: -
 Type approval no.: -
 Road-Map/Abo: -

Background process is being carried out
 Vehicle test (Read fault memory)

Display action plan Start vehicle test Search information

R2106100027

6. "Reading vehicle data" may be displayed

Integrated Service Technical Application
 8/11/2021 10:40:22 AM

VIN W020439 Read vehicle data (NBTEVO) KL 15: -- KL 30: --

Cases Vehicle information Vehicle management Service plan

Vehicle details Vehicle equipment Control unit tree Control unit list Service Case report

ZGM BDC

HU-H TCB IHKA KOMBI DME ACSM DSC PMA FLEL SMFA
 AMPT CON ASD KAFAS EGS EPS VIP FRS FLER FZD
 TRSVC GWS GHAS VDP HRSNR HRSNL

ETHERNET K-CAN4 PT-CAN FLEXRAY K-CAN3 PT-CAN2 K-CAN6 K-CAN2

Fault memory Present Control unit responsive Control unit unresponsive Control unit with programming abort

Start vehicle test Call up control unit functions

7. After “Background process is being carried out” has ended, the “Control unit tree” screen appears.

Note: When Fault memory “Present” or “Existing” is displayed at the bottom left of the screen, check for DTCs. Note that this campaign does not cover the diagnostic fees and/or repairs for any DTC’s.

The screenshot shows the 'Control unit tree' screen in the Integrated Service Technical Application. The interface includes a top navigation bar with tabs for 'Cases', 'Vehicle information', 'Vehicle management', and 'Service plan'. The 'Control unit tree' tab is active, showing a hierarchical diagram of control units. The diagram is connected to a central bus labeled 'ZGM' and 'BDC'. Below the diagram, a legend indicates the status of control units: 'Control unit responsive' (green), 'Control unit unresponsive' (yellow), 'Control unit with programming abort' (blue), and 'Control unit not fitted' (grey). A red box highlights the 'Fault memory Present' status at the bottom left. The bottom right corner of the screen displays the text 'R2106100031'.

Note: If the dialog box in the image appears when the screen changes to “Control unit tree” screen, click “OK” to close the dialog box, and then continue work. Toyota ISTA will attempt to establish a data exchange with the central server. In the absence of an available connection route (because of no Internet connection is available or the PC connection isn’t setup), Please verify your connection and click “OK”.

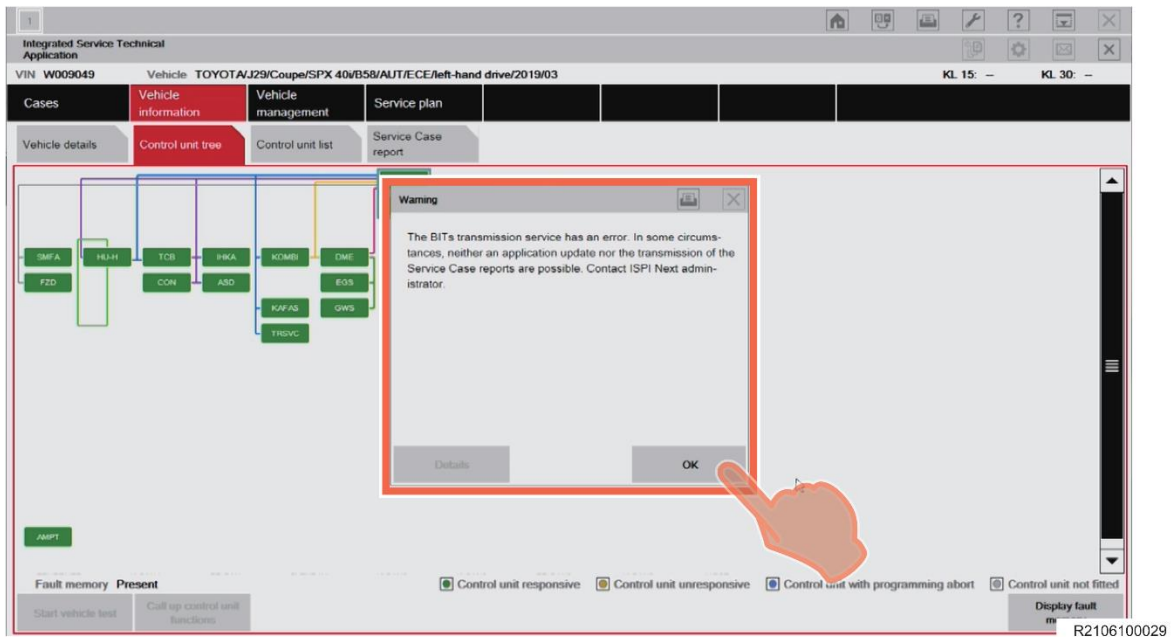

C. CHECK I-LEVEL

1. Select "Vehicle details".
2. The "Vehicle details" screen appears. Check the displayed "Current I level:", and then refer to the table below to determine if the vehicle requires reprogramming.

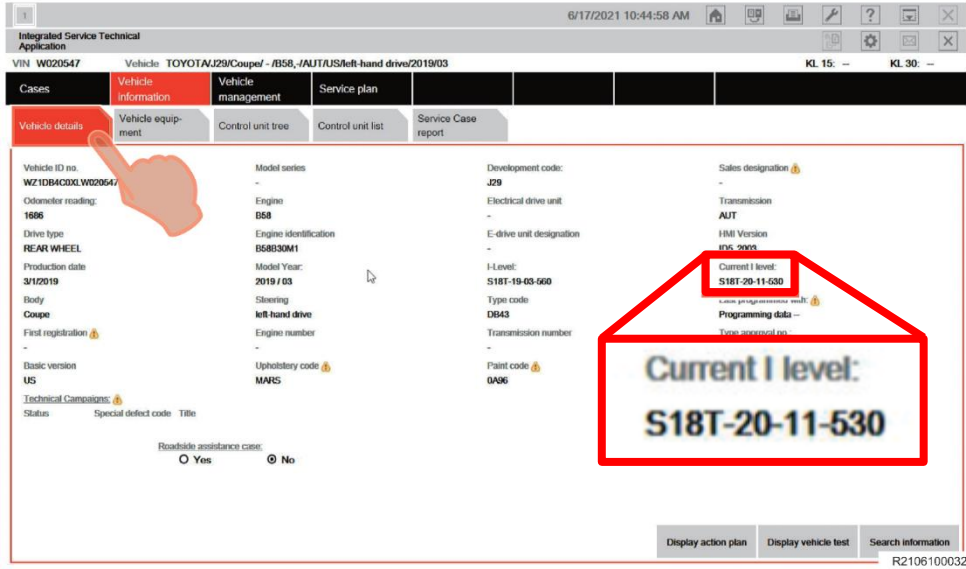

3. Confirm if the vehicle requires reprogramming based upon the "Current I-Level" of the vehicle. Use the decoder below.

Result	"Current I-Level" of Vehicle	Required Action
NG	Lower than S18T-21-07-519	REPROGRAMMING REQUIRED. Continue with this procedure.
OK	Equal to or Greater than S18T-21-07-519	WORK IS COMPLETE. Reprogramming is not required. Refer to page 34 for instructions on closing out of ISTA and disconnecting the diagnostic cable.

How to Decode I-Level Superiority

I-Level: S18T-19-03-330

1
2
3
4

- 1: Series (vehicle model)
- 2: Year Released
- 3: Month Released
- 4: Serial Number

EXAMPLE:

Lower: S18T-19-03-585

Higher: S18T-19-07-555

In the example, S18T-19-07-555 is higher than S18T-19-03-585 because it was released in a later month (July compared to March).

XVII. PERFORM THE REPROGRAMMING (UPDATING I-LEVEL)

A. PERFORM THE REPROGRAMMING

1. Perform the reprogramming if the vehicle's current I-Level is lower than **S18T-21-07-519**.
2. Select "Service plan" -> "Programming plan".
3. The screen changes to the "Action plan" screen and "Please wait" message appears.

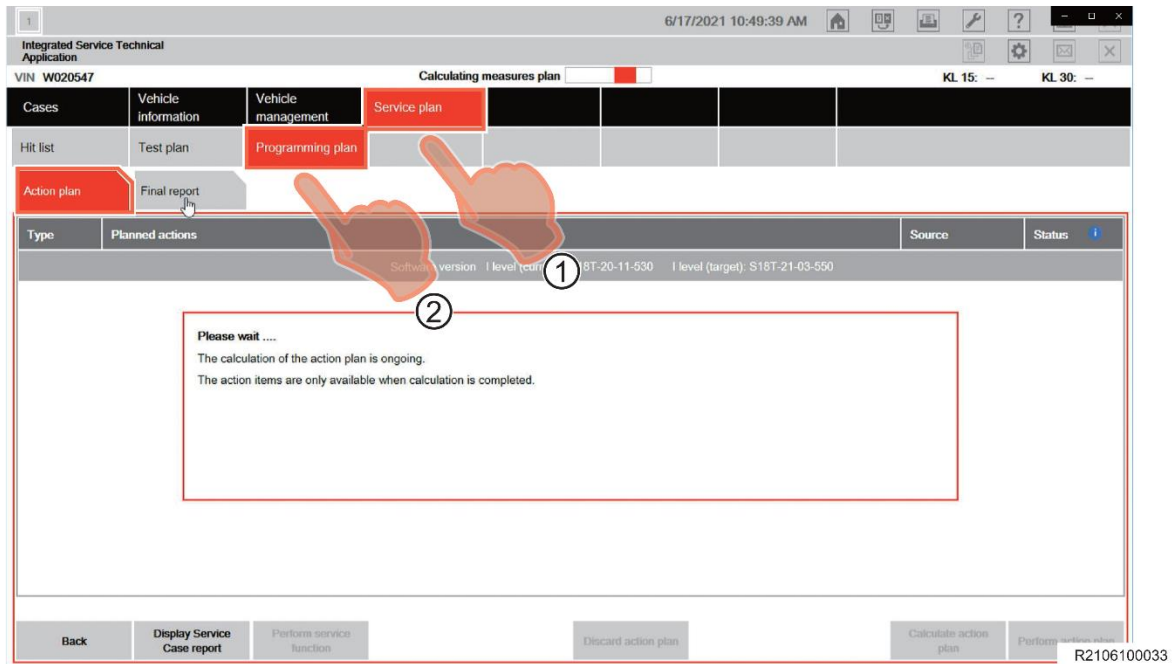

4. After the "please wait" message closes and the screen changes, click "Perform action plan".

Note: After clicking "Perform action plan", carry out the on-screen instructions of Toyota ISTA reliably.

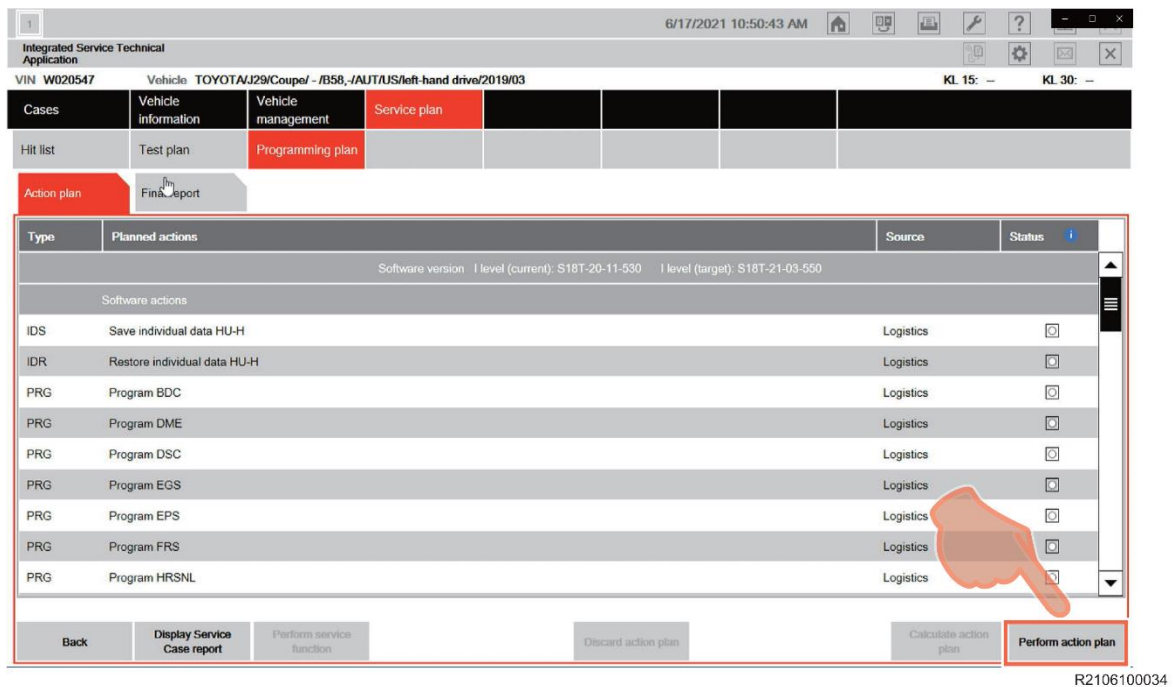



If you see the following screen during reprogramming:

- DO NOT SWITCH OFF THE IGNITION**
- DO NOT DEACTIVATE PAD MODE**
- DO NOT DISCONNECT THE BATTERY CHARGER**
- DO NOT OPEN ANY DOORS OR INSERT ANY SEAT BELTS**
- DO NOT DISCONNECT THE DIAGNOSTIC CABLE**

Leave the car as is, and call TAS (Technical Assistance).



If for any reason during the reprogramming, you believe the update is “frozen” or has otherwise failed:

- DO NOT TURN THE IGNITION OFF**
- DO NOT DISCONNECT THE BATTERY CHARGER**
- DO NOT OPEN ANY DOORS**
- DO NOT DISCONNECT THE DIAGNOSTIC CABLE**

Leave the vehicle as is and call TAS for assistance. TAS will likely be able to help you recover the vehicle.

5. "Executing measures plan" appears the top middle of the screen (header line). Check the content that is displayed in the "Information" dialog box, and then click "OK".

The screenshot shows the 'Integrated Service Technical Application' interface. At the top, the header 'Executing measures plan' is highlighted with a red box. Below the header, there are several tabs: 'Cases', 'Vehicle information', 'Vehicle management', 'Service plan', 'Hit list', 'Test plan', 'Programming plan', 'Action plan', and 'Final report'. The 'Action plan' tab is active, displaying a table of planned actions. An 'Information' dialog box is open in the center, displaying the message 'Ignition turned on?' and an 'OK' button, which is highlighted with a red box and a hand icon pointing to it. The background table shows various software actions like 'Save individual data HU-H', 'Restore individual data HU-H', and several 'Program' entries (BDC, DME, DSC, EGS, EPS, FRS, HRSNL) with a 'Logistics' source and a status icon.

R2106100035

6. "Warning!" and "Notice!" will be displayed in the "Attention!" dialog box. Check the content in the dialog box, and then click "Continue" to continue the "Action plan".

The screenshot shows the 'Integrated Service Technical Application' interface. At the top, the header 'Executing measures plan' is highlighted with a red box. Below the header, there are several tabs: 'Cases', 'Vehicle information', 'Vehicle management', 'Service plan', 'Hit list', 'Test plan', 'Programming plan', 'Action plan', and 'Final report'. The 'Action plan' tab is active, displaying a table of planned actions. An 'Attention!' dialog box is open in the center, displaying a 'Warning!' message: 'The determination of connected/existing data media was not clear.' Below the warning is a 'Notice!' message: 'In general, all data media (CD, DVD, USB, iPod®, etc.) must be removed before vehicle programming! If ignored, this will lead to programming abortions and the data on the data media will be deleted.' The dialog box also contains a 'Procedure as follows:' section with three bullet points: 'Manually check all the drives specified above.', 'Any inserted or connected data media must be removed.', and 'Then, continue with the execution of action plan using the "Next" button. With the button "Cancel", the execution of the action plan is canceled.' The 'Continue' button is highlighted with a red box and a hand icon pointing to it. The background table shows various software actions like 'Save individual data HU-H', 'Restore individual data HU-H', and several 'Program' entries (BDC, DME, DSC, EGS, EPS, FRS, HRSNL) with a 'Logistics' source and a status icon.

R2106180002

7. Please check carefully the content displayed in the “Preparation for the vehicle programming” dialog box, and then click “Continue”.

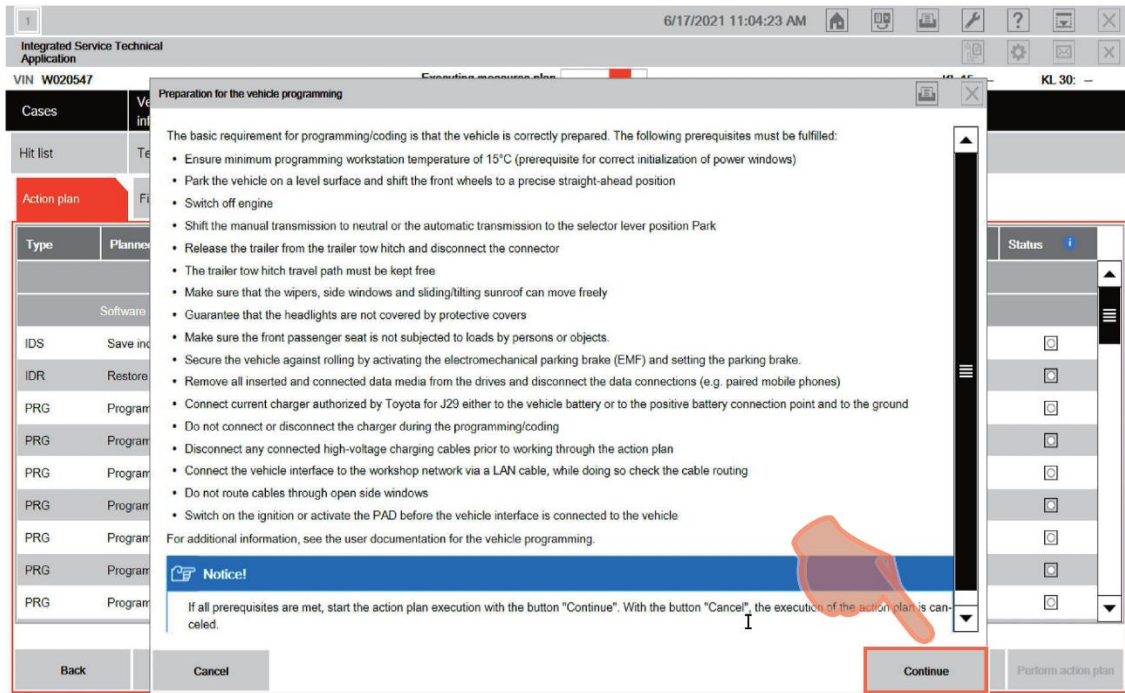

R2106100036

NG

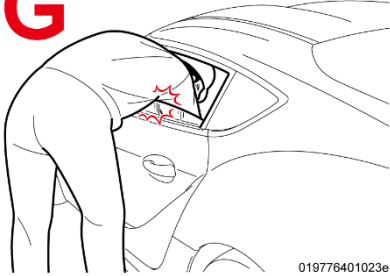

019776401023e



DO NOT put your head or hand in the window of the vehicle you are reprogramming. Since the window may close automatically at the time of initialization, there is the risk of being be pinched and injured.

NG

Do not Open and Close

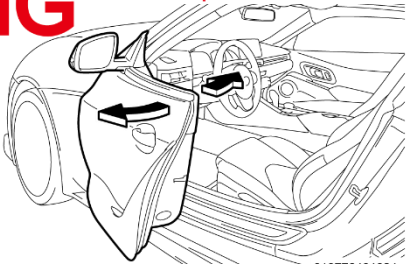

019776401024e



DO NOT open or close the driver's door during the programming routine.



The programming could take a long time. Ensure that the vehicle is not accidentally disturbed by other team members during the reprogramming.

8. The top middle of the screen (header line) switches to “Saving individual data”. “Save individual data HU-H” is executed first. If it completes normally, a checkmark (✓) is displayed in the “Status” column.

The screenshot shows the 'Integrated Service Technical Application' interface. At the top, a progress bar indicates 'Saving individual data' with a remaining time of 'One minute'. Below this, a table lists planned actions. The first row, 'IDS Save individual data HU-H', is highlighted with a red border and has a green checkmark in the 'Status' column. Other actions include 'Restore individual data HU-H', 'Program BDC', 'Program DME', 'Program DSC', 'Program EGS', 'Program EPS', 'Program FRS', and 'Program HRSNL', all with status icons.

Type	Planned actions	Source	Status
Software version: I level (current): S18T-20-11-530 I level (target): S18T-21-03-550			
Software actions			
IDS	Save individual data HU-H	Logistics	✓
IDR	Restore individual data HU-H	Logistics	🔄
PRG	Program BDC	Logistics	🔄
PRG	Program DME	Logistics	🔄
PRG	Program DSC	Logistics	🔄
PRG	Program EGS	Logistics	🔄
PRG	Program EPS	Logistics	🔄
PRG	Program FRS	Logistics	🔄
PRG	Program HRSNL	Logistics	🔄

R2106180004

The 'State Values' dialog box displays status icons for two categories: Programming Actions and Service functions. Programming Actions include: not called (square), successful (checkmark), Warning (warning triangle), running (square with vertical lines), failed (cross), and not executable (cross with slash). Service functions include: not called (square), performed (square), canceled (square), suspected (square), and minimized (square).

R2106100038

Note: The icons in the diagram indicate the status.

9. The top middle of the screen (header line) switches to “Executing Software actions”. When “Warning” dialog box appears, click “OK”.

The screenshot shows the 'Integrated Service Technical Application' interface. At the top, the header indicates 'Executing software actions' with a remaining time of 48 minutes. Below the header is a navigation bar with tabs for 'Cases', 'Vehicle information', 'Vehicle management', 'Service plan', 'Hit list', 'Test plan', 'Programming plan', 'Action plan', and 'Final report'. The 'Action plan' tab is active, displaying a table of planned actions. A 'Warning' dialog box is overlaid on the table, containing the following text: 'Be aware: A case with programming is active! Check LAN cable and voltage supply and secure if necessary! If the instruction is not followed, a programming abort will result.' The 'OK' button in the dialog box is highlighted with a red rectangle and a hand icon. The table of planned actions has columns for 'Type', 'Planned actions', 'Source', and 'Status'. The 'Status' column shows a green checkmark for the first row and a warning icon for the others.

Type	Planned actions	Source	Status
IDS	Save individual data HU-H	Logistics	✓
IDR	Restore individual data HU-H	Logistics	⚠
PRG	Program BDC	Logistics	⚠
PRG	Program DME	Logistics	⚠
PRG	Program DSC	Logistics	⚠
PRG	Program EGS	Logistics	⚠
PRG	Program EPS	Logistics	⚠
PRG	Program FRS	Logistics	⚠
PRG	Program HRSNL	Logistics	⚠

R2106180003

10. The reprogramming progress status of each ECU is displayed in the “Status” column. The overall progress status of reprogramming is indicated by “Executing software actions” at the top center of the screen (header line), which shows the reprogramming progress status and approximate “Remaining time”.



- Even when the “Status” column is filled with checkmarks (✓), always check the display at the top center of the screen (header line) for the progress status, because initialization and other work is being carried out in addition to reprogramming.
- Wait until the reprogramming is finished before manipulating the ISTA software to avoid interfering with the reprogramming.

Type	Planned actions	Source	Status
IDS	Save individual data HU-H	Logistics	✓
IDR	Restore individual data HU-H	Logistics	🔄
PRG	Program BDC	Logistics	🔄
PRG	Program DME	Logistics	🔄
PRG	Program DSC	Logistics	🔄
PRG	Program EGS	Logistics	🔄
PRG	Program EPS	Logistics	🔄
PRG	Program FRS	Logistics	🔄
PRG	Program HRSNL	Logistics	🔄

R2107270006a

11. "Executing follow-up operations" is displayed in the center of the screen (header line).

The screenshot shows the Integrated Service Technical Application interface. At the top, the date and time are 6/17/2021 11:38:52 AM. The VIN is W020547. The header line displays "Executing follow-up operations" in a red box. Below the header, there are tabs for "Cases", "Vehicle information", "Vehicle management", "Service plan", "Hit list", "Test plan", "Programming plan", "Action plan", and "Final report". The "Action plan" tab is selected. The main area displays a table of planned actions:

Type	Planned actions	Source	Status
Preparation/follow-up operations			
ABL	CBS Service Inclusive selection	System	🕒
ABL	CBS data recovery follow-up operation	System	🕒
ABL	CBS data recovery preparer	System	✅
ABL	Check EPS initialization	System	🕒
ABL	Control units reset DSC	System	🕒
ABL	Delete fault memory	System	🕒
ABL	FAS control unit reset	System	🕒
ABL	Heating and air conditioning functions: Calibration run for flap motors	System	🕒
ABL	Lock airbag	System	🕒
ABL	MOST: Storing the desired configuration	System	🕒

At the bottom, there are buttons: "Back", "Display Service Case report", "Perform service function", "Discard action plan", "Calculate action plan", and "Perform action plan".

R2106100041

Note: If the following "Information" dialog box is displayed during "Executing follow-up operation", click "OK" to continue the follow-up operation. After reprogramming is complete, follow the on-screen instructions and carry out initialization and other work.

The screenshot shows the same Integrated Service Technical Application interface as above, but with an "Information" dialog box overlaid. The dialog box contains the following text:

Information

There are still fault code entries.
Switch to troubleshooting for the fault handling to work through the faults present therein.

The "OK" button in the dialog box is highlighted with a red box and a hand icon. The background table shows the following actions:

Type	Planned actions	Source	Status
Software actions			
IDS	Save individual data HU-H	Logistics	✅
IDR	Restore individual data HU-H	Logistics	✅
PRG	Program DSC	Logistics	✅
PRG	Program HRSNL	Logistics	✅
PRG	Program HRSNR	Logistics	✅
PRG	Program VIP	Logistics	✅
COD	Code BDC	Logistics	✅
COD	Code DSC	Logistics	✅
COD	Code HRSNL	Logistics	✅

At the bottom, there are buttons: "Back", "Display Service Case report", "Perform service function", "Discard action plan", "Calculate action plan", and "Perform action plan".

R2106100042

Note: If the following dialog box appears, click “OK”.

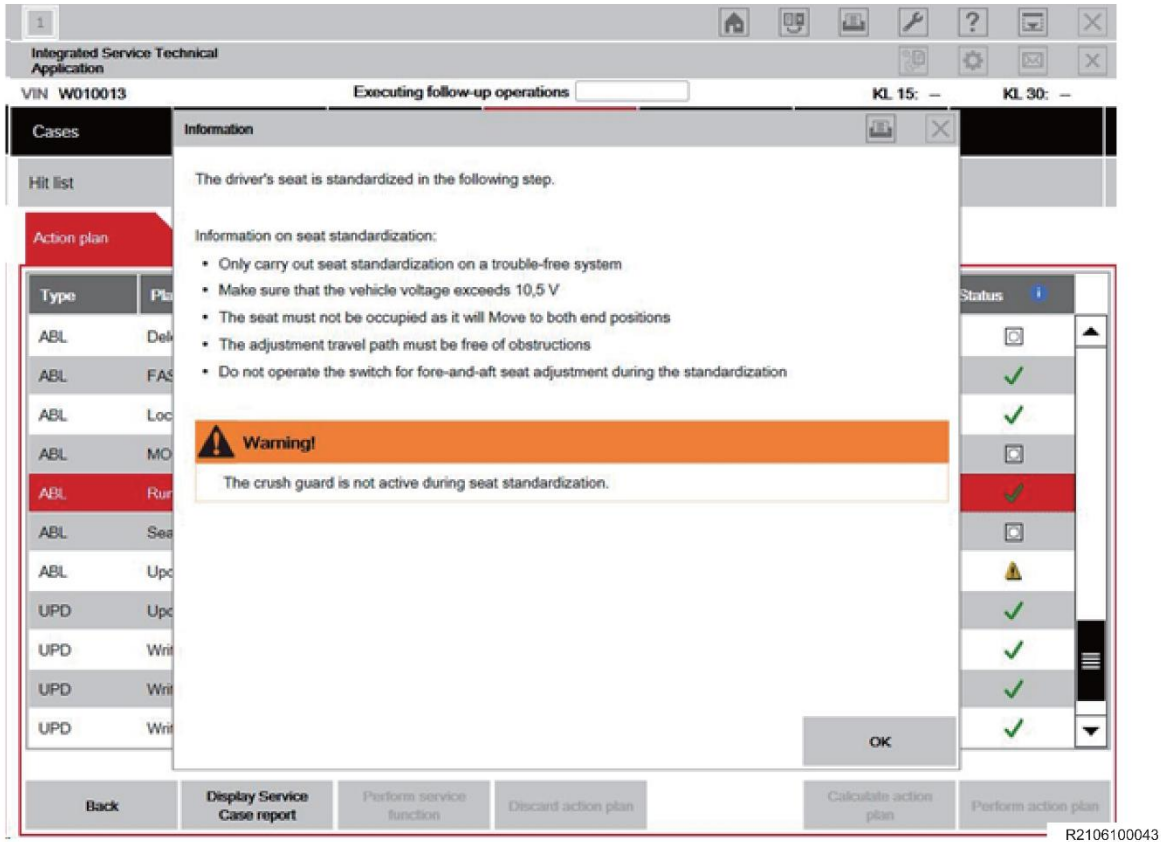

12. “Calculating final context” appears at the center of the screen (header line). At the same time, a “Please wait...” message appears to allow for the completion of the action plan.

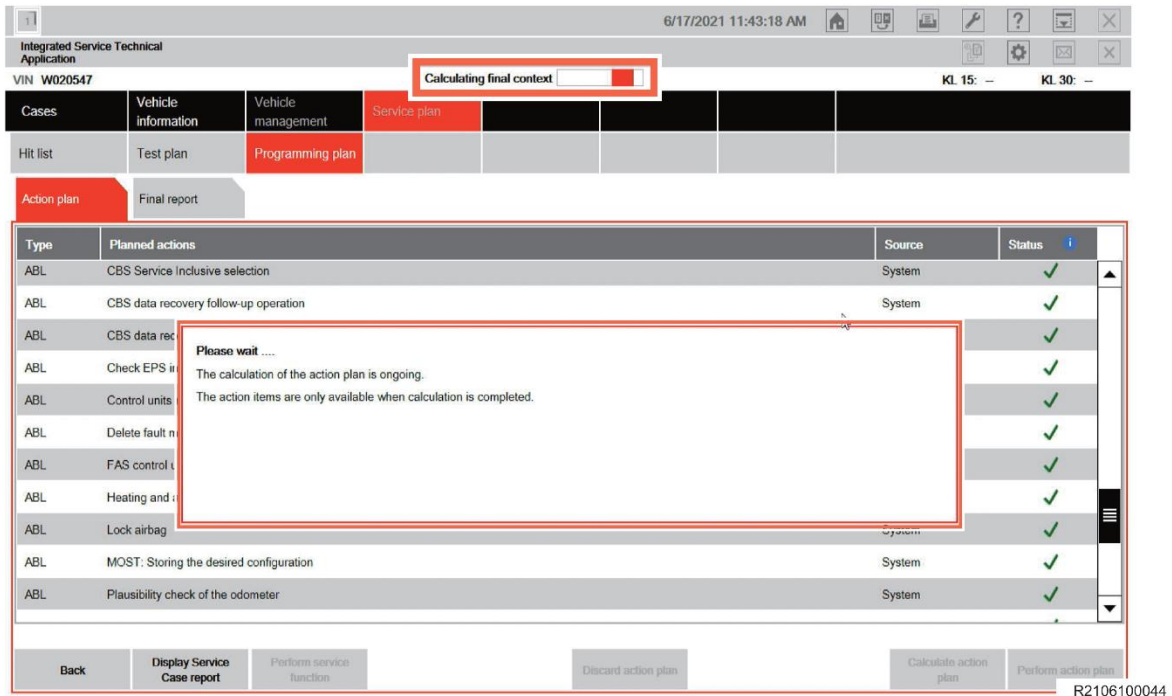

13. After the “Status of action plan implementation” dialog box appears, click “OK”.

The screenshot displays the Integrated Service Technical Application interface. At the top, the title bar shows the date and time: 6/17/2021 11:45:30 AM. Below the title bar, the application name is 'Integrated Service Technical Application'. The main header area contains the VIN 'W020547' and the vehicle description 'TOYOTA/J29/Coupe/ - /B58, /AUT/US/left-hand drive/2019/03'. On the right side of the header, there are two indicators: 'KL 15: -' and 'KL 30: -'. The main content area is divided into several sections. On the left, there is a navigation pane with tabs for 'Cases', 'Vehicle information', 'Vehicle management', 'Service plan', 'Hit list', 'Test plan', 'Programming plan', 'Action plan', and 'Final report'. The 'Service plan' tab is currently selected. In the center, a dialog box titled 'Status of action plan implementation' is open. The dialog box contains the following text: 'The implementation of the action plan is complete. The check for subsequent work is required.' Below the text, there are two buttons: 'Details' and 'OK'. The 'OK' button is highlighted with a red box, and a hand icon is pointing to it. On the right side of the dialog box, there is a table with columns 'Source' and 'Status'. The table contains one row with the source 'S18T-21-03-550' and a status indicator (a blue square with a white dot). At the bottom of the application, there is a footer area with several buttons: 'Back', 'Display Service Case report', 'Perform service function', 'Discard action plan', 'Calculate action plan', and 'Perform action plan'. The ID 'R2106100045' is visible in the bottom right corner.

14. NOTICE: After reprogramming has completed Toyota-ISTA may request additional functions to complete. These additional functions may include initialization of seats, windows, mirrors or headlights. Toyota-ISTA may provide instructions such as ensuring there are no obstructions of the object that requires initialization. Please follow all necessary on-screen prompts and ensure that the vehicle is parked in a safe manner to complete each initialization. If these directions are not followed properly, the vehicle could produce additional DTCs.

In the example shown below, the “ride height sensors: start-up” service function” needs to be performed.

If ride height is required, you will need to insert the ride height for both the front and rear wheels. This will require you to measure this height in millimeters. The repair manual procedure can be found in this location:

[Vehicle Exterior > LIGHTING \(EXT\) > HEIGHT CONTROL SENSOR > INSTALLATION](#)
5. ADJUST HEIGHT CONTROL SENSOR (DOC ID: RM10000001JCL5)

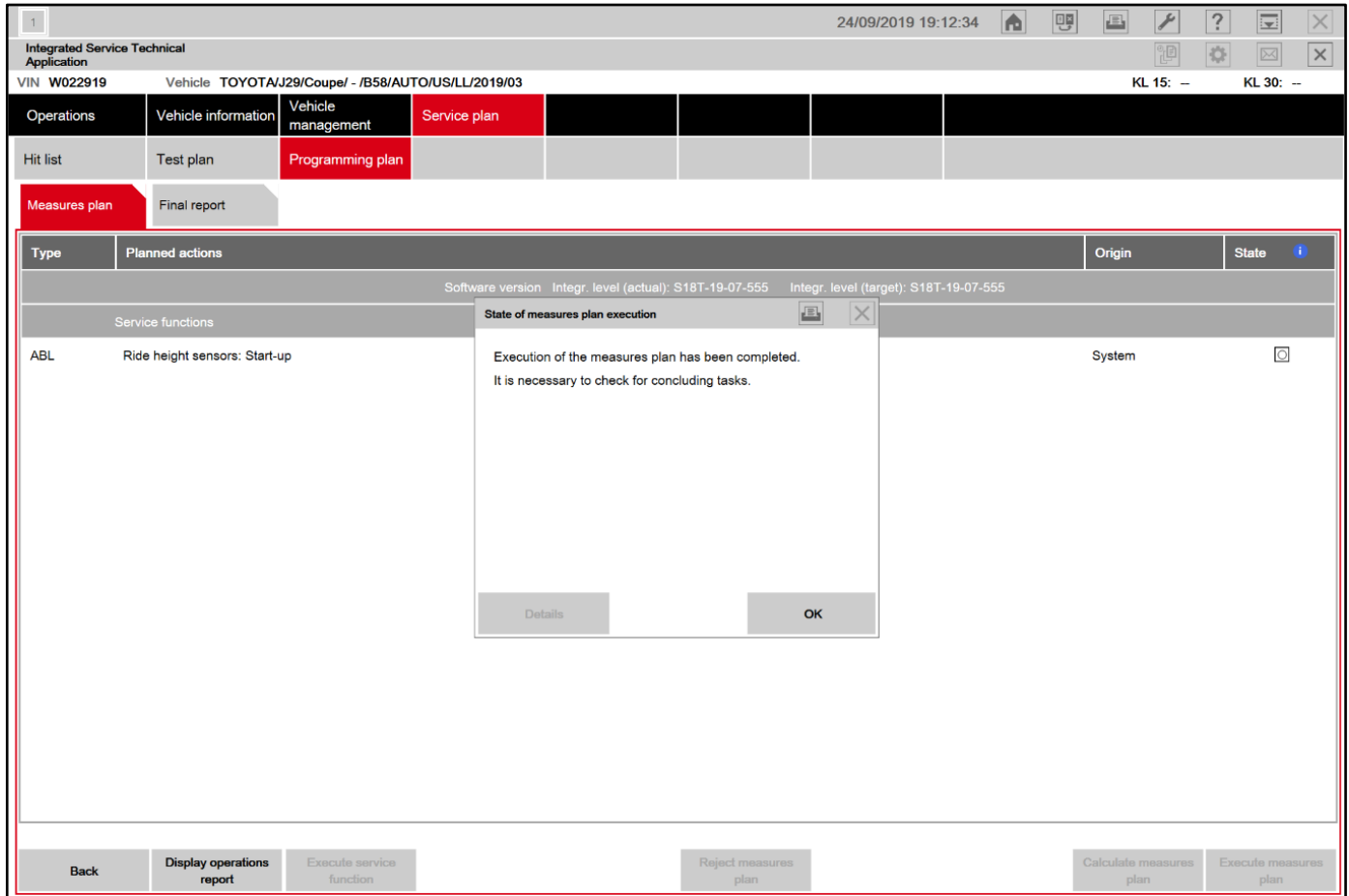

15. Click on "Action plan"

16. Check the I-Level. Make sure that the "(current)" and "(target)" I-Levels are equal.

The screenshot shows the Integrated Service Technical Application interface. At the top, the date and time are 6/17/2021 11:45:45 AM. The VIN is W020547 and the vehicle is a TOYOTA/J29/Coupe/ - /B58, -/AUT/US/left-hand drive/2019/03. The interface has a navigation bar with tabs: Cases, Vehicle information, Vehicle management, Service plan, and a sub-tab for Programming plan. A red arrow points to the 'Action plan' button. Below the navigation bar, there is a table with columns: Type, Planned actions, Source, and Status. The table contains one row: 'Software version I level (current): S18T-21-07-519 | I level (target): S18T-21-07-519'. A callout box highlights this row with the text: 'I-Level of "(current)" and "(target)" are equal.' At the bottom of the interface, there are buttons: Back, Display Service Case report, Perform service function, Discard action plan, Calculate action plan, and Perform action plan. The ID R2107060004a is visible in the bottom right corner.

Type	Planned actions	Source	Status
	Software version I level (current): S18T-21-07-519 I level (target): S18T-21-07-519		

I-Level of "(current)" and "(target)" are equal.

17. Ensure the current I-Level meets or exceeds **S18T-21-07-519**.

18. If the I-Level does not meet or exceed **S18T-21-07-519**, go to Section X to confirm that you are using the proper version of Toyota ISTA.

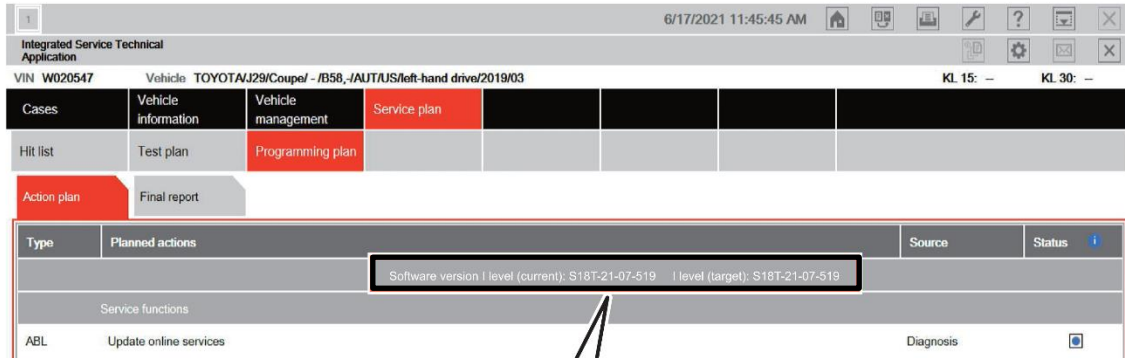

Software version I level (current): S18T-21-07-519 I level (target): S18T-21-07-519

Ensure the current I-Level
meets or exceeds
S18T-21-07-519

XVIII. DISCONNECT TOYOTA ISTA

A. CLOSE OUT OF TOYOTA ISTA

1. Select "Cases" -> "Active" to display the "Case list".
2. Confirm the vehicle information is correct, and then click "Close case".

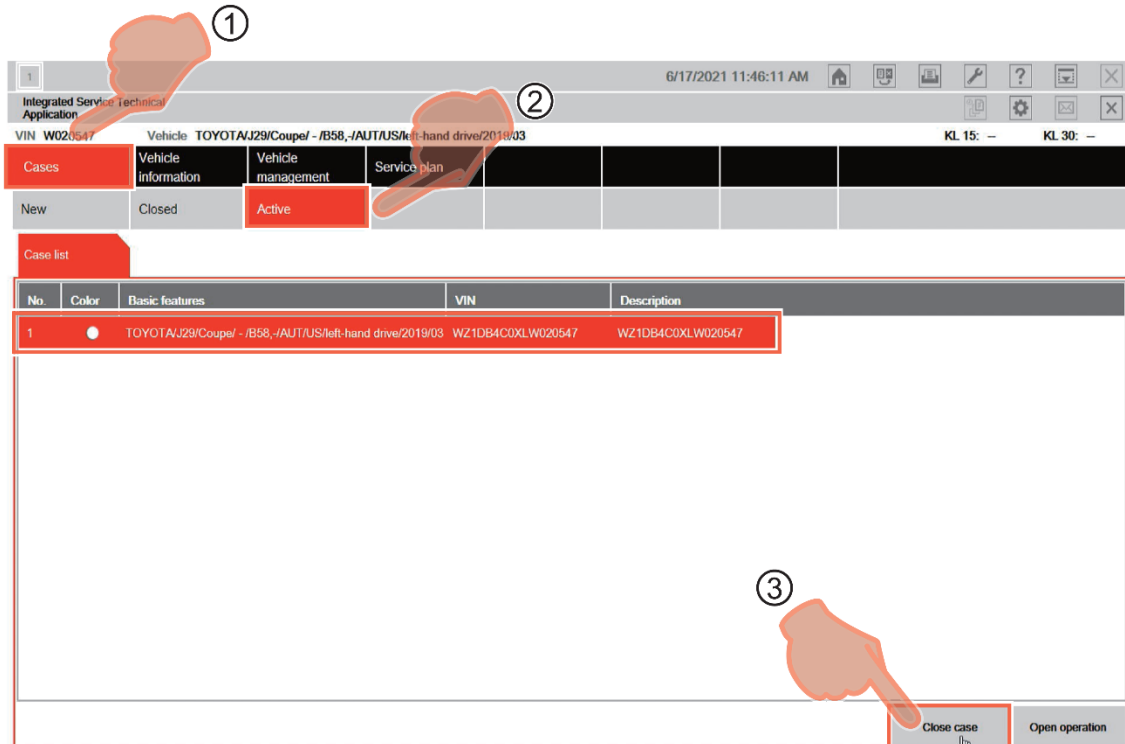

R2106100047

3. When the “Open actions in action plan” dialog box appears, click “Yes”.

The screenshot shows the Integrated Service Technical Application interface. At the top, the date and time are 6/17/2021 11:46:13 AM. The application title is "Integrated Service Technical Application". Below this, the VIN is W020547 and the vehicle information is TOYOTA/J29/Coupe/ - /B58, - /AUT/US/left-hand drive/2019/03. The status is KL 15: - and KL 30: -. The main area displays a table with columns: Cases, Vehicle information, Vehicle management, and Service plan. The "Active" status is highlighted in red. A "Case list" dialog box is open, showing a table with columns: No., Color, and Basic features. The first row shows "1" in the No. column and "TOYOTA/J29/Coupe/ - /B58, - /AUT/US/left-hand drive" in the Basic features column. A dialog box titled "Open actions in the action plan" is overlaid on the case list. The dialog box contains the following text: "There are still open actions present in the action plan. These actions must be completed before closing the case. Do you want to close the case anyway?". Below the text are two buttons: "No" and "Yes". A red hand icon is pointing to the "Yes" button. At the bottom right of the application window, there are buttons for "Close case" and "Open operation", and the reference number R2106100048.

Cases	Vehicle information	Vehicle management	Service plan
New	Closed	Active	

No.	Color	Basic features
1		TOYOTA/J29/Coupe/ - /B58, - /AUT/US/left-hand drive



Open actions in the action plan

There are still open actions present in the action plan.
These actions must be completed before closing the case.
Do you want to close the case anyway?

No Yes

Close case Open operation R2106100048

4. Make sure that the frame of the icon at the left end of the toolbar at the top left of the screen has turned gray, and then click “x”.
5. You may have to click the frame icon in the left end of the tool bar in order to close the case.

Icon	Color and Status	Meaning
	Gray	Job Completed; Click ☒ at the Right on the Toolbar.
	Rotating Animation	Work in Progress; Wait Until Color is Grey.
	Flashing Animation	There is a warning message; a response is required. Click the icon, and then follow the on-screen instructions to carry out the work.

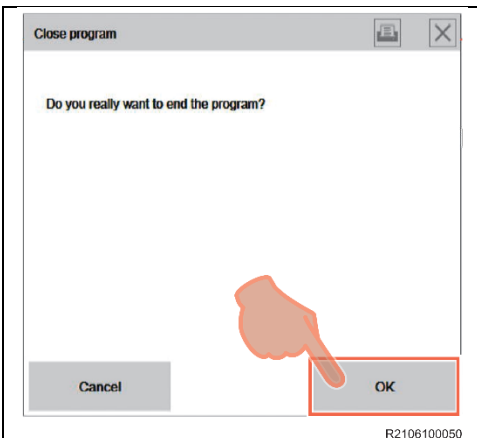
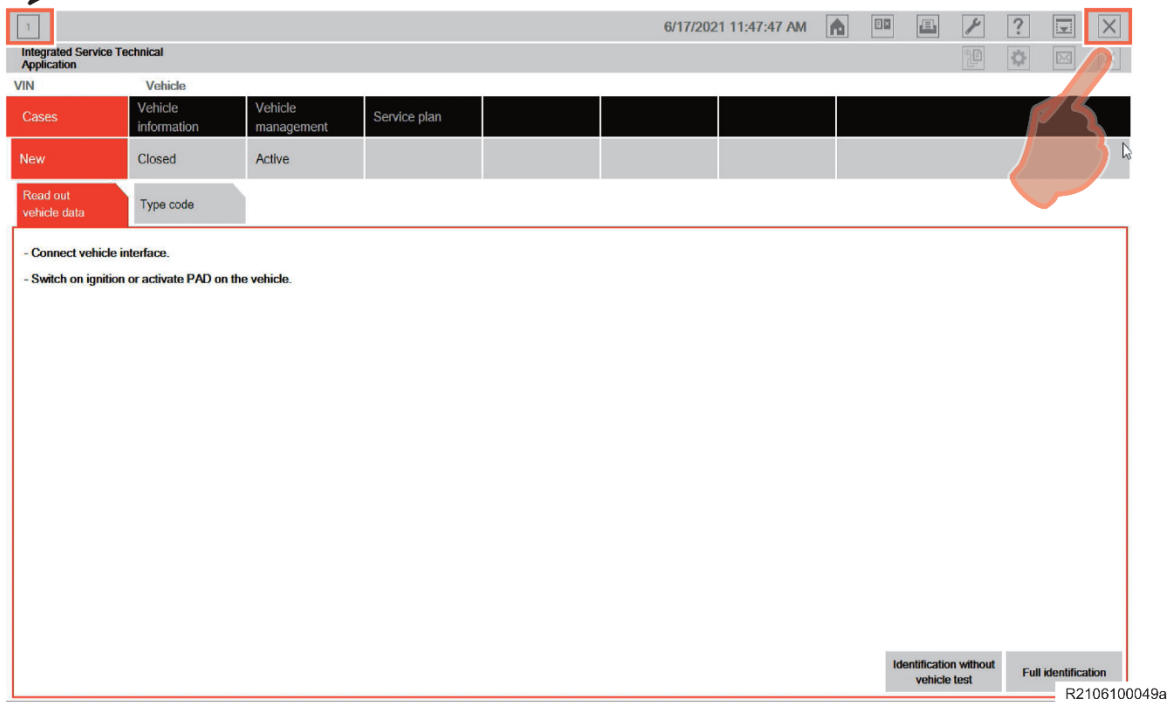

6. Click “OK” when the “Close program” dialog box appears.

R2106100050

7. Open the driver-side door, press the Start/Stop button once, and then close the door.

Note: PAD mode is turned off, and the headlights are turned off by opening the driver-side door, pressing the Start/Stop button once, and then closing the door.

8. Disconnect the ISTA diagnostic cable and battery charger.

XIX. PLACE VEHICLE IN SLEEP MODE FOR 15 MINUTES

A. Place vehicle in sleep mode for 15 minutes

1. It is necessary to place the vehicle in sleep mode for 15 minutes to allow the KOMBI and fuel tank ECU to establish the correct size of fuel tank.
2. Sleep mode can be activated by shutting all the doors, hood, trunk and parking the vehicle for 15 minutes with keys away from the vehicle.

◀ VERIFY REPAIR QUALITY ▶

- Confirm the I-Level meets or exceeds **S18T-21-07-519**. This Safety Recall is not considered completed until the I-Level of the vehicle is **S18T-21-07-519** or greater.

XX. CAMPAIGN DESIGNATION DECODER

19TA01

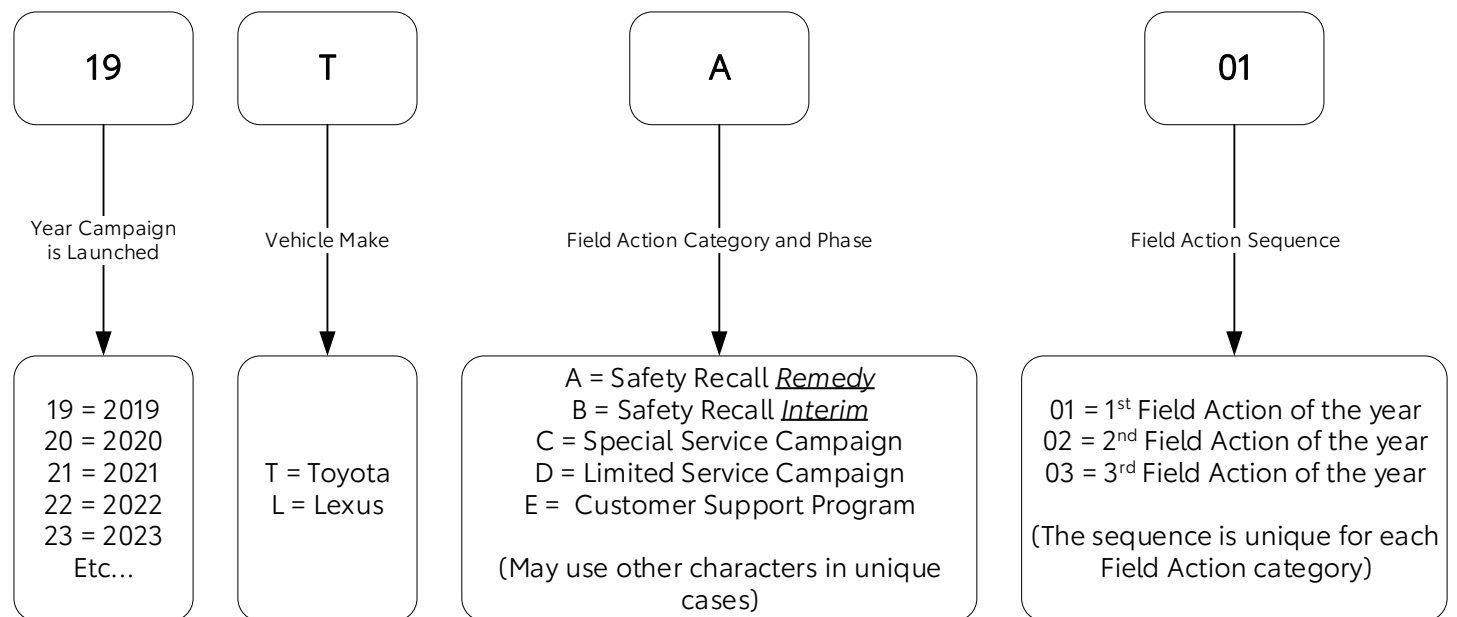

Examples:

19TA01 = Launched in 2019, Toyota, Safety Recall Remedy Phase, 1st Safety Recall Launched in 2019
20TC02 = Launched in 2020, Special Service Campaign, 2nd Special Service Campaign Launched in 2020
21TE05 = Launched in 2021, Customer Support Program, 5th Customer Support Program Launched in 2021