

**Campaign code:**

L62X-R.02.21

Campaign Name:

Rear View Camera not available - Kombi update

Model:Huracán 4WD, Huracán 2WD, Huracán Performante,
Huracán EVO**Model year:**

2018, 2019, 2020, 2021

Special or limited editions:

All versions

Markets:

Only USA and Canada

VIN identification:

From JLA06855 to MLA16389

Important: before proceeding with the repair, connect to the warranty portal and use VIN Info to check that

- The vehicle is actually affected by the instructions given in this bulletin; some vehicles may not be, even when their VIN is included.
- Procedures are identified by a letter (e.g. A, B or C...etc., whose differences will be explained later in this bulletin); make sure that the spare parts corresponding to the assigned procedure are used.

Example

Code	Type	Description	Bulletin	Proc.
LXX-A.XX.XX		CAMPAIGN NAME		B

**NOTE:**

Procedure A will be available only when the instructions require a preliminary check to be performed to determine whether or not the vehicle actually needs updating.

Network information notice:

As a result of continuous product monitoring, Automobili Lamborghini S.p.A. has determined that some vehicles were manufactured with a software bug within the infotainment system which when subjected to temperatures below 41 degrees Fahrenheit and after a long sleep may some-times generate a fault that renders the rear view (back-up) camera inoperable until the next power latch.

Operations:

The following instructions include the options:

- **OPTION B:** Kombi sw update and configuration

Solutions for the network:

Update the car as stated in the instructions.

**IMPORTANT!**

Before carrying out the operations contained in this bulletin, please execute any other campaigns planned for this vehicle in the time order in which they were issued. The time order can be identified by the name of the bulletin. Example: L62X-A-08.20 is bulletin number 8 of 2020.



Replacement parts:



IMPORTANT!

When the VIN is entered in the LIASS system, the specific operation to be performed on that vehicle will be specified. On the basis of the operation displayed on LIASS, please order one of the following codes associated with the operations concerned, where suggested:

OPTION B: Kombi sw update and configuration

P/N	Description	Q
N90799102	PAN HEAD BOLT W/ MULTI-POINT DRIVE, SELF-LOCKING	1

Labour:

- **OPTION B: 2,00 h**

Bulletins superseded:

None.

Warranty instructions:

To request reimbursement for the corrective action performed, access the Warranties section of the Lamborghini Portal and follow the "Campaigns" entry instructions in the W.Claim manual which can be downloaded from the Portal.

Select the required campaign and proceed with entry, carefully reading the options present in the alert displayed by the system (see example) and select the option performed on the vehicle.

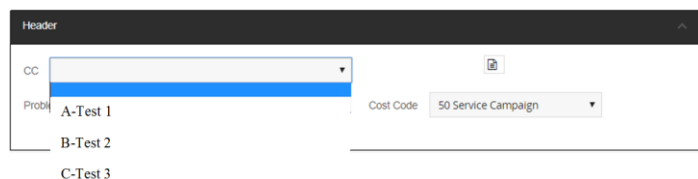

Depending on the option performed, the reimbursement will be structured in the following manner:

- **OPTION B:** Kombi sw update and configuration
 - o Steps to be executed: I, II, III, IV, V
 - o Labour time: 2,00 h
 - o Spare parts: N90799102



WARNING!

Attach all documents generated during the work carried out as evidence of the work itself, for instance workshop orders, diagnostic protocols etc. If one or more of these is missing it may lead to a rejected reimbursement request.

Fill out the Service and Recall Campaign section in the warranty booklet, which is shown in the figure below.

Tools/Materials required

Cod.	Description	Q
n/n	n/n	0



IMPORTANT:

Before you follow the instructions in this service campaign, you need to install the SD-Creator program. The instructions for installing SD Creator are contained in the bulletin: "BI.09.17_[ENG]_SD-Crea-



for installation package procedures". Follow the instructions in the "BI.25.18" information bulletin to upgrade the SD-Creator to the latest version available.



IMPORTANT:

Automobili Lamborghini S.p.A. informs that the time necessary to download the software from SD-Creator is not to be considered refundable on a case by case basis, being exceptional and acceptable with the extra-time already included in the time given for operation B.

Preliminary operations:

1. Ensure you have recently synced with the mirror server by checking the last synchronization date:

<http://mirrorserver/maintenance/diagnosis.py>

or by directly entering the Btac-box IP address:

[http://\[IP_address\]/maintenance/diagnosis.py](http://[IP_address]/maintenance/diagnosis.py)

if you have not previously set the IP alias of the mirror server.

(e.g. <http://12.34.567.890/maintenance/diagnosis.py>)



IMPORTANT:

Make sure that the last synchronization was performed after January 21, 2021.

MS/2 Diagnosis

Configuration	
Base path	/var/www/desert
Provider URL	https://altair.mirrorserver2.net/deployment
Repository URL	https://altair.mirrorserver2.net/storage
Feedback URL	https://altair.mirrorserver2.net/health
Proxy	not used
Key file	/var/www/desert/certs/userkey.pem
Certificate	/var/www/desert/certs/usercert.pem
Tests	
Local file/directory permissions	OK
Disk space	OK
Provider reachable	OK (altair.mirrorserver2.net)
Repository reachable	OK (altair.mirrorserver2.net)
Feedback reachable	OK (altair.mirrorserver2.net)
Provider WebDAV access	OK (https://altair.mirrorserver2.net/deployment)
Repository WebDAV access	OK (https://altair.mirrorserver2.net/storage)
Feedback WebDAV access	OK (https://altair.mirrorserver2.net/health)
Successful package downloads	9
Failed package downloads	0
Last Sync	21/01/20 23:34:47

[Start tests](#)



NOTE:

The instructions contained in this bulletin are based on the ODIS diagnosis software updated to version 7.1.1 and the Lamborghini 2.29.0 or later database (refer to information bulletin BI.06.21 and make sure that ODIS Service is properly updated on the laptop).

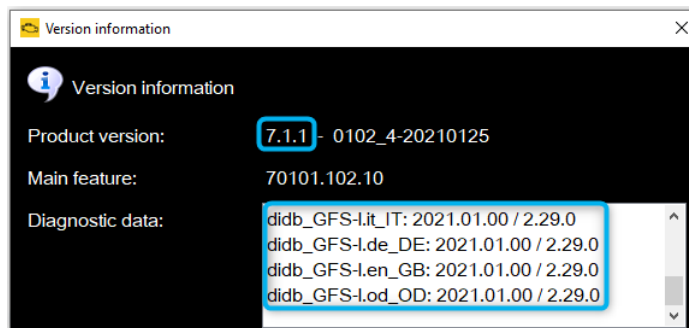

2. It is essential that you connect an appropriate battery charger to the charge points available in the luggage hood (front center of the vehicle). Please refer to the following figure

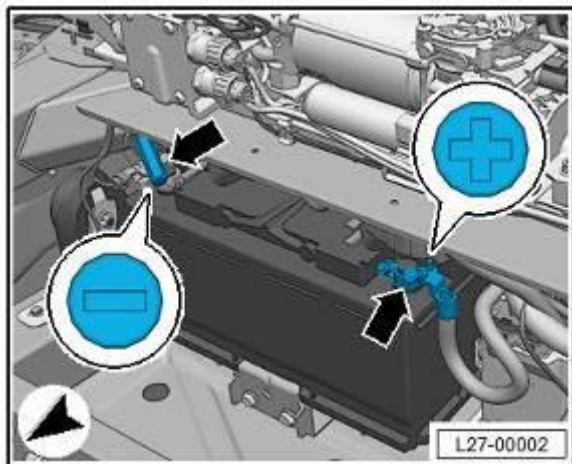

Work instructions:

The updating procedure described here includes the following steps:

- I. Download SW from SD-Creator;
- II. Kombi unmounting;
- III. Kombi sw update and configuration;
- IV. Final operations.



IMPORTANT:

*Do not perform other types of activity on the car while executing the campaign.
 Carrying out the procedure blindly implies unsolvable damage to the control unit and resulting replacements.*



NOTE:

Ensure the key ON and engine OFF during the whole update procedure. Start a diagnostic session with ODIS service and keep the diagnostic interface connected to the OBD socket and do not close the ODIS Service program or use it for other purposes. Once the software update has been executed it is necessary to complete the operation in ODIS.

I. Download SW from SD-Creator

1. In order to download the necessary software for the update procedure, open on your laptop the software SD Creator by a double click on the program icon.

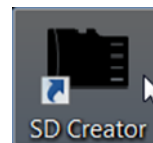

2. When the program starts, fill in the Windows screen fields as explained in the "BI-09.17_[ENG]_SD-Creator installation package procedures".

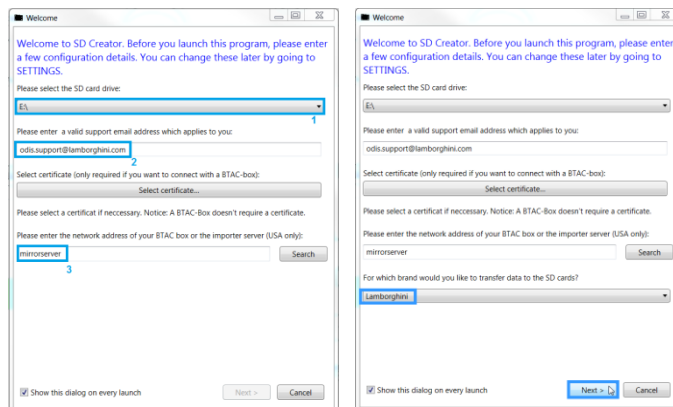

3. In the main page of SD Creator fill out the Model and Part Number fields:

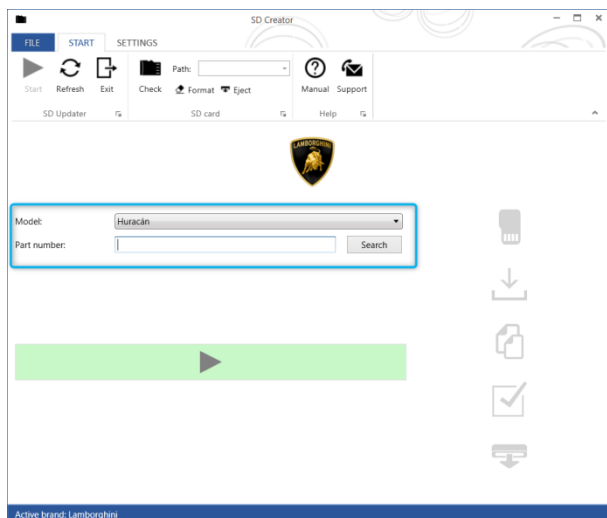

- a. Select the Model, (Huracán);
- b. Insert the USB memory stick and type the Part Number specific for your destination market making reference on the table at following point.

4. Select the Part Number related to the destination market of your vehicle:

Table of reference for control unit 17 (Kombi)		
Part Number	Software Target	Destination Vehicle
616.530.017.95	1898	Huracán 4WD Huracán 2WD Huracán Performante
616.530.017.96	1981	Huracán EVO

5. Through the Part Number selected, the version of the ECU 17 software suitable to the selected market will be downloaded. Then, click "Search". The following image is only for example purposes:



6. If the entered part number is correct, following the search, will be shown the model name and the required size of the USB memory stick to generate the software. E.g.:

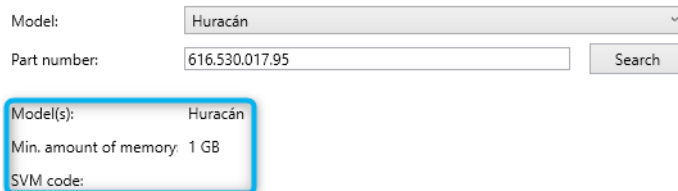

IMPORTANT:

Before start to download the software!

The process involves formatting the USB memory and deleting the files inside it.

In order to avoid to lose the data, it is advisable to use empty USB memory.

Make sure that the available storage space is larger or at least equal to the the size required by SD Creator, as indicated at the point 5.



ATTENTION:

If the error shown in the following image occurs in the download from SD Creator, perform the instructions at the end of this document, in Trouble shooting section.

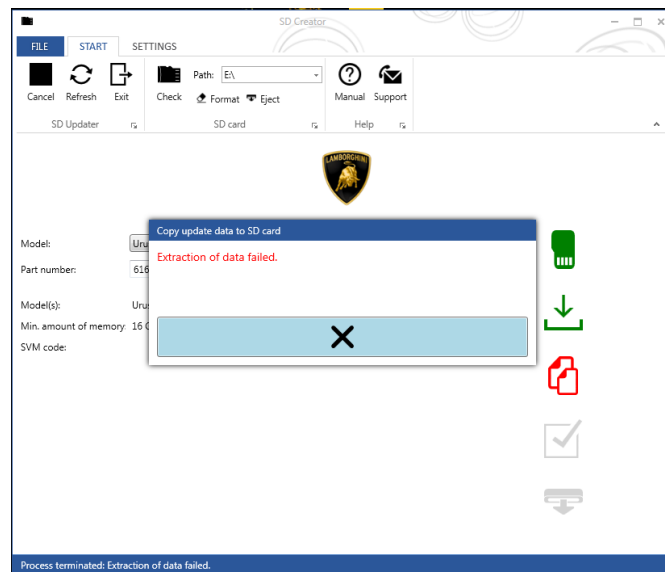

7. Follow the instructions to download the software. Click the Start Button,



, to start the software download process. The software will be automatically saved in the USB memory stick.

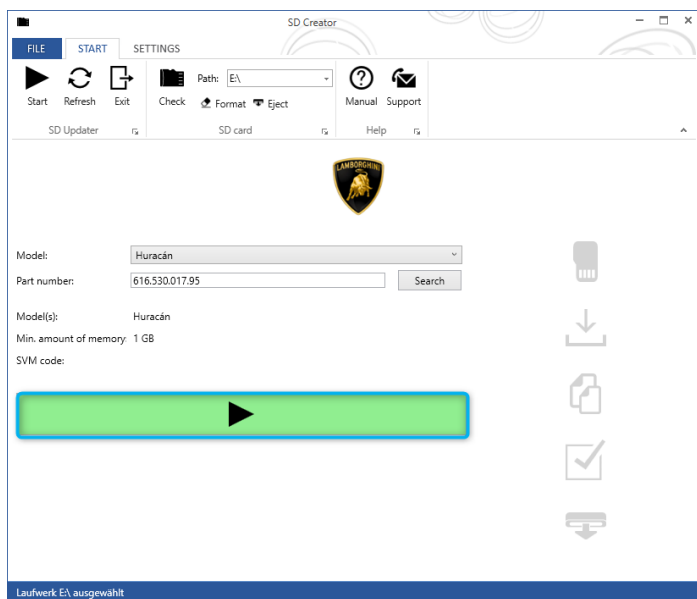

8. At the end of the process, green icons will appear on the right and a positive feedback will be displayed indicating the success of the operation. Click on the bar "✓" in order to finish the download process. The USB memory stick is automatically unplugged from your laptop.

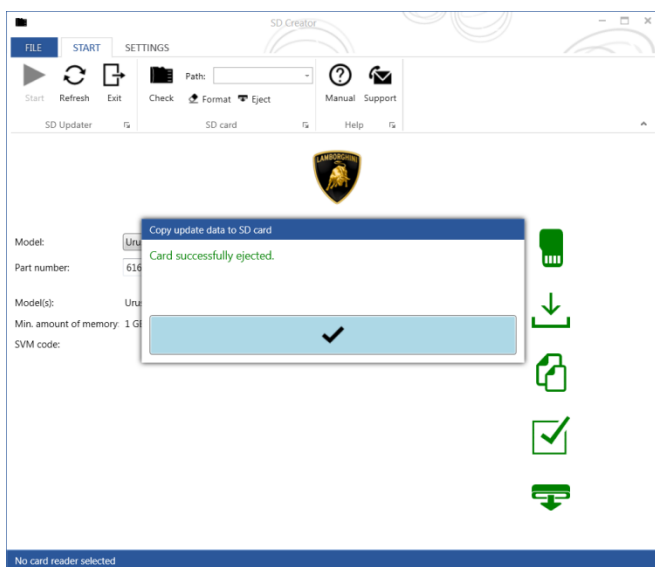

9. To verify the success of the operation, extract and reinsert the USB stick and make sure that the software required is present. The following image is an example concerning the folders created.

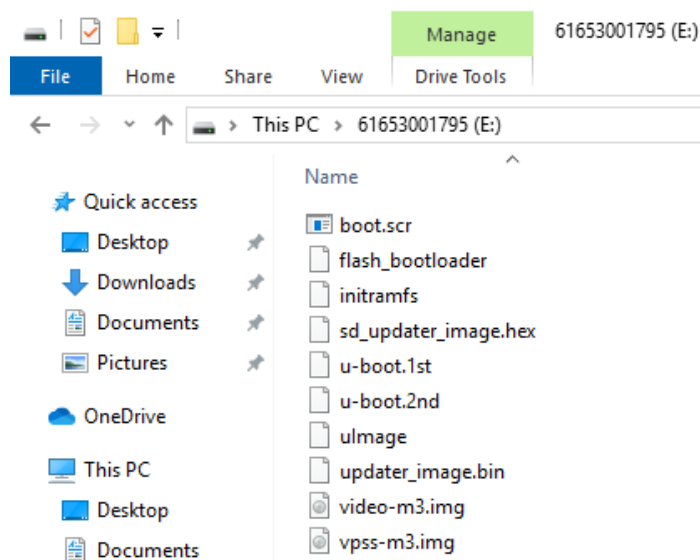

10. At this point the downloaded software is available on the USB memory stick and ready to be flashed on the car.



II. **Kombi unmounting**

- 11.** Turn the steering wheel to access the airbag retaining springs, then apply leverage to unhook them.

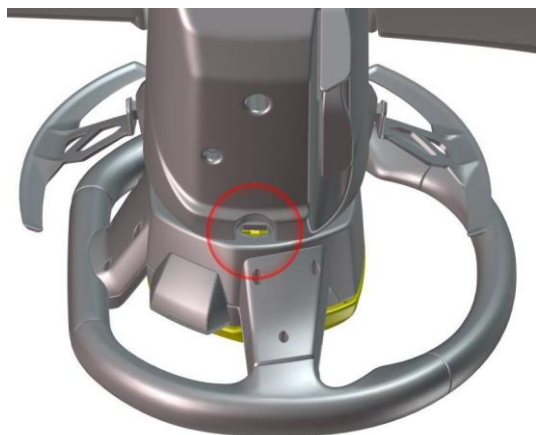

62x15_0001366

- 12.** Disconnect the connector then remove the airbag module.

Position the airbag as shown in the figure.



WARNING:

Static electricity discharges can cause the airbag to deploy.

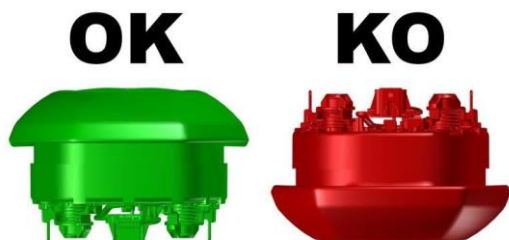

62x15_0001368

- 13.** Straighten the front wheels. Keep the front wheels straight throughout the procedure. Unscrew the retaining bolt and remove the steering wheel. When reinstalling, line up the reference on the steering wheel with the one on the steering column and **make sure to replace the fastener shown in the image below (code N90799102).**

Tightening torque: **30 Nm + 90°**

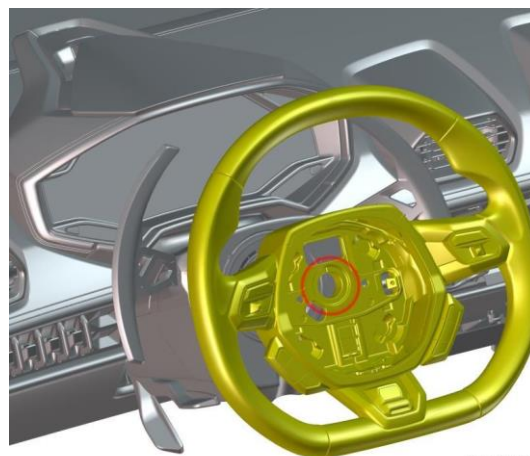

62x15_0000433



IMPORTANT:

During the reassembly **DO NOT** re-utilize the old fastener, make sure to install a new one (code N90799102).

- 14.** Unscrew the retaining screw and remove the side cover on the steering column.

Repeat this operation on both sides.

Tightening torque: **2.5 Nm**

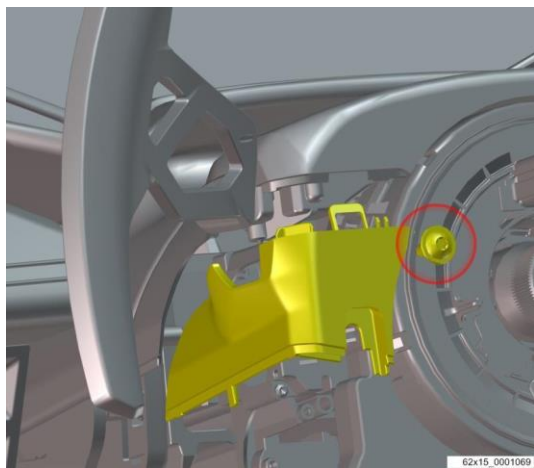

- 15.** Unscrew the retaining screw, extract the electrical wiring then remove the lower cover of the steering column.

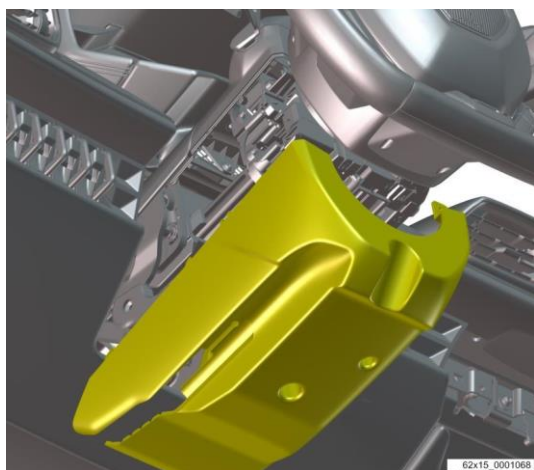

- 16.** Pull the air vent, disconnect the electrical wiring then remove it from the instrument panel.

Perform this operation for the air vents at the sides of the instrument cluster.

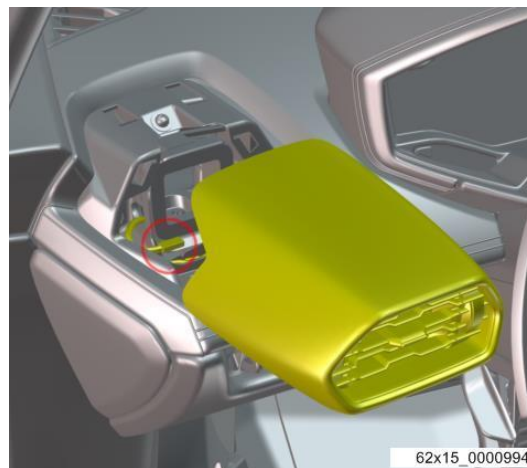

- 17.** Remove the cap and unscrew the retaining screw of the complete instrument cluster.

Tightening torque: **2.5 Nm**

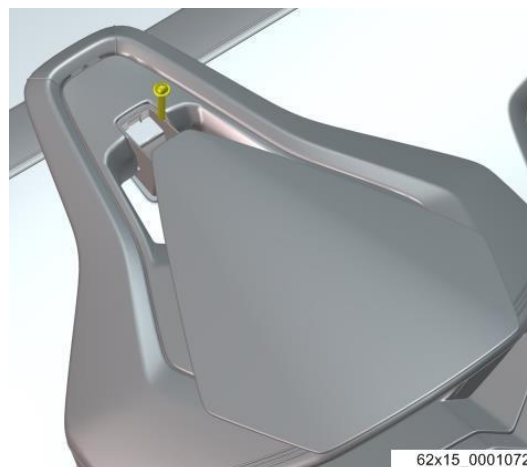

- 18.** Lift the fabric cover and unscrew the two retaining screws of the complete instrument cluster.

Tightening torque: **2.5 Nm**

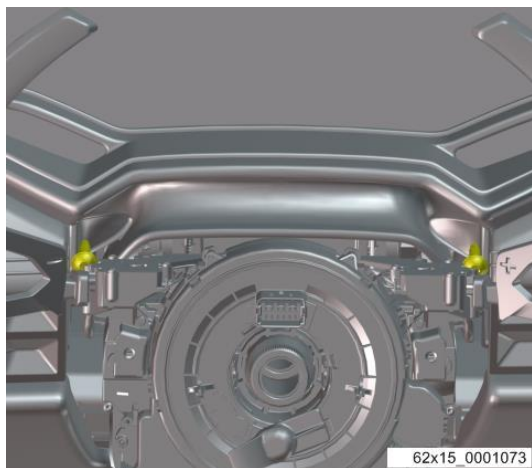

19. Unscrew the retaining screw of the instrument cluster located inside the air vent housing.

Repeat this operation on both sides.

Tightening torque: **2.5 Nm**

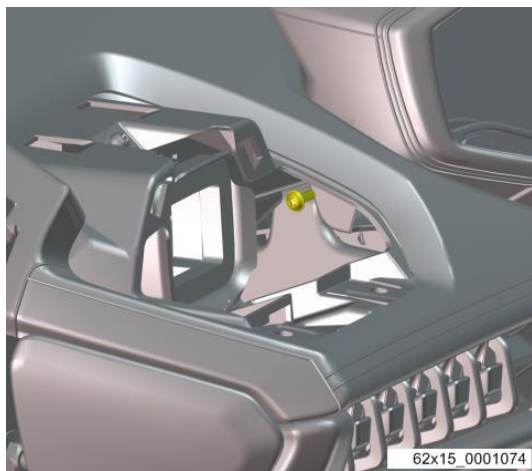

20. Disconnect the electrical wiring then remove the complete instrument cluster from the vehicle.

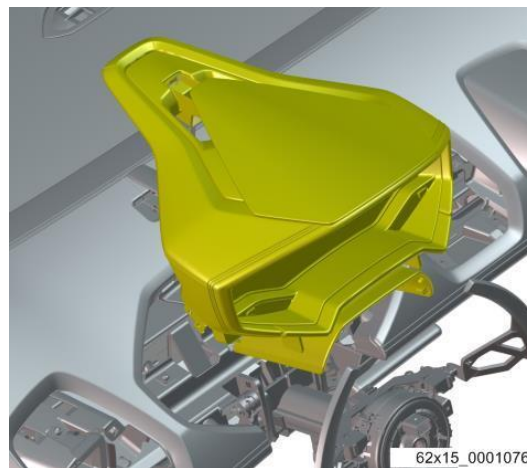

III. Kombi sw update and configuration

Refer to the procedure in the workshop manual regarding "Implementation of an SVM code".



IMPORTANT:

Improper use of this function can cause damage to the ECUs.

21. To start the procedure to execute an SVM code, select the "Special functions" card in ODIS.

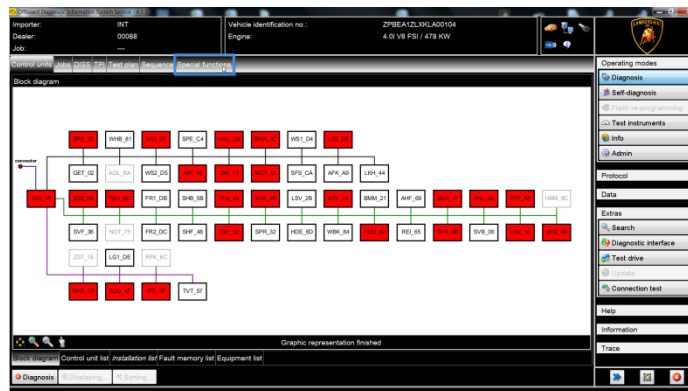



22. Click on "SVM-Direct input: SVM for problem-related update" and then on "Perform test".

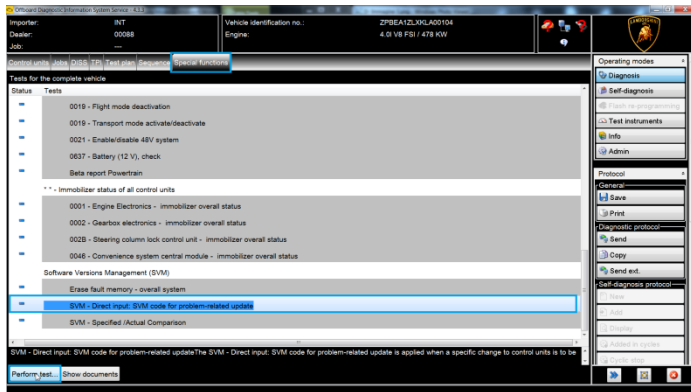

23. Enter the code "L62XR0221A" in the appropriate space at the top right and click "Adopt".

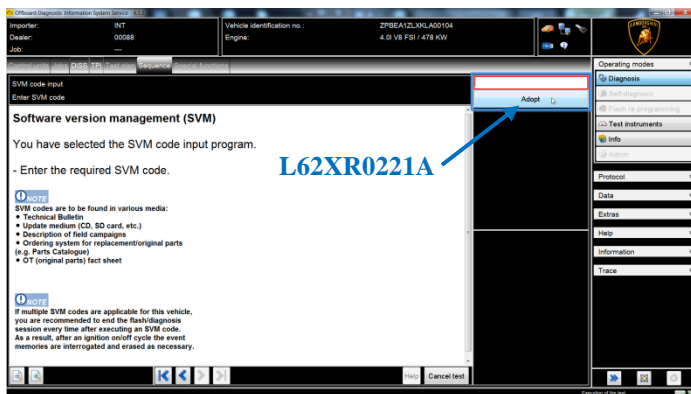

24. The SVM code entered is again displayed in the dialog box. If the entered code is correct, click on "Yes". Otherwise click on "No" to cancel the SVM procedure.

25. Wait for data to be acquired from all the control units. This operation requires a few minutes.

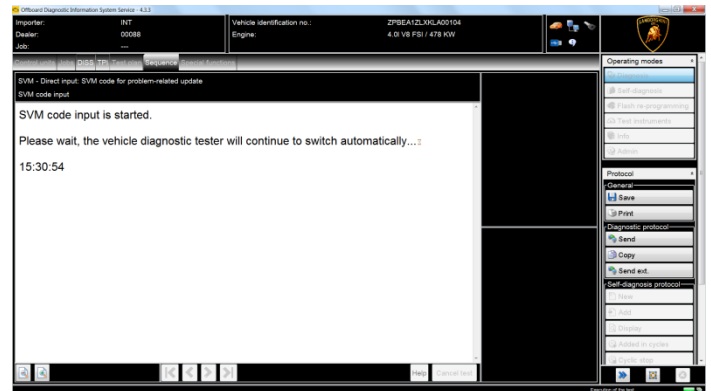

26. To run the SVM function and access the Lamborghini servers, you must have a valid GeKo account. Ensure that the laptop is correctly connected to the Internet. Enter your GeKo username in the "User name" field and the PIN 1324 + the 6-digit code currently displayed on the GeKo token in the "Password" field.

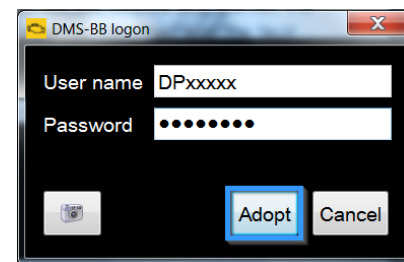

Click "Adopt" to confirm.

27. The SVM function will automatically continue with identification of the control units in the vehicle.

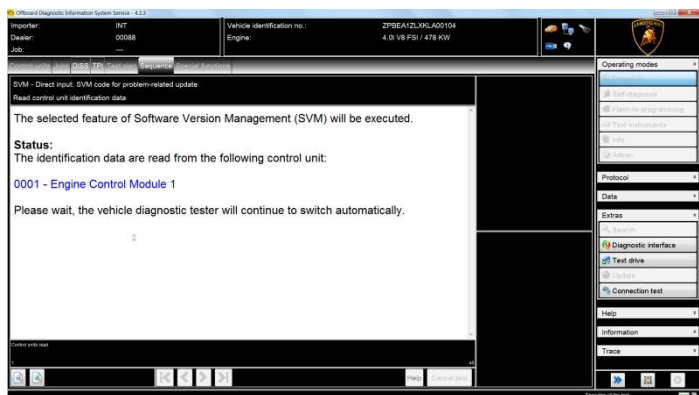

28. Do not follow the instructions given by the tester, but instead press "Cancel test" to exit the SVM.

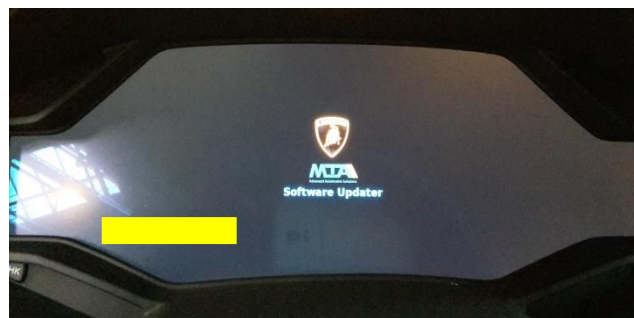

29. Wait for completion of the update, indicated by the yellow progress bar below the display as shown in the first image, until it disappears completely and the Instrument Cluster turns back on, as indicated in the second image.

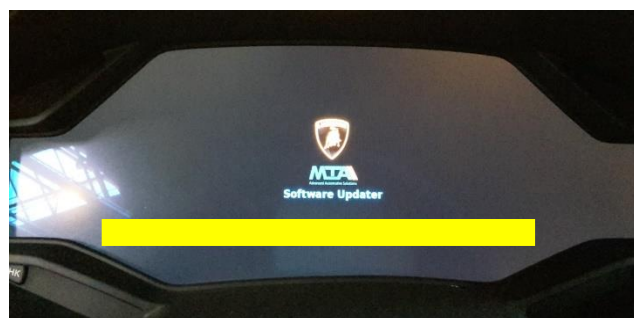
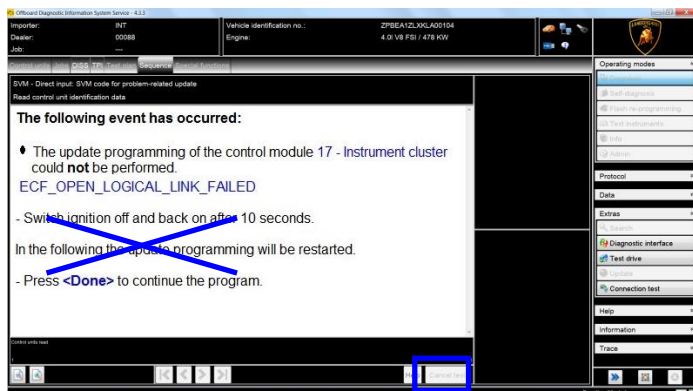

Leave the ODIS tester connected, which will return to its initial page, then follow the instructions on the Instrument Cluster.



NOTE

At this point, the Kombi will turn off and search for the software on the micro SD card. With the micro SD card inserted, the screen will remain off completely for several minutes until the update screen appears with a yellow progress bar.



30. Repeat steps 27 to 33 to run the SVM program again with campaign code **L62XR0221B**.

31. It might become necessary to perform one or more of the following operations in the SVM procedure:

- Coding;
- Parameterization;
- Calibration.

To perform these actions, it is usually necessary to click on "Done/Continue" where requested and to follow the instructions directly provided on the ODIS dialog screens.

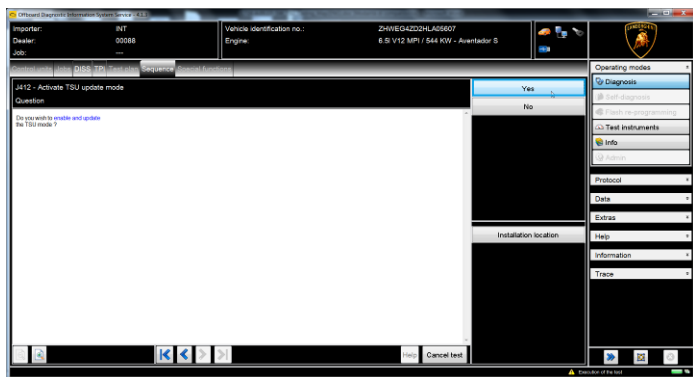

32. From the Guided Functions of the ECU 17 run the function "**17 - Identification**" and check if the information indicated in "Software Version" is the same shown in the following table, along with the vehicle type (the following image is used as example):

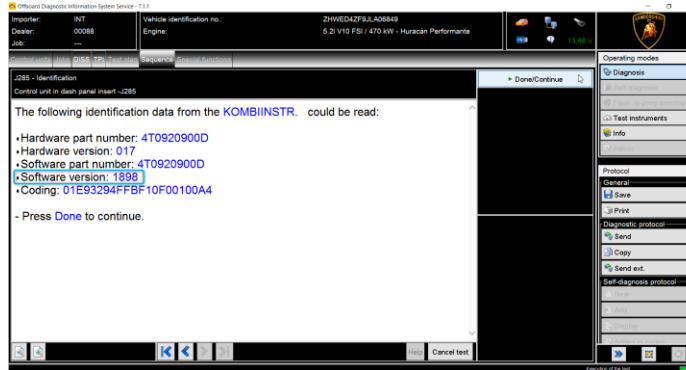

Table of reference for control unit 17 (Kombi)	
Software Target	Destination Vehicle
1898	Huracán 4WD Huracán 2WD Huracán Performante
1981	Huracán EVO

IV. Final operations

33. Turn the key to OFF and remove the Instrument Cluster from the vehicle.



34. Carefully remove the micro SD card from the slot in the instrument cluster and retain it for future use.

35. Install the instrument cluster in the vehicle and perform the first ten points of this procedure (unmounting) in reverse order.

36. Select the "Special Functions" card and then "Erase fault memory - overall system" in order to delete all stored faults.

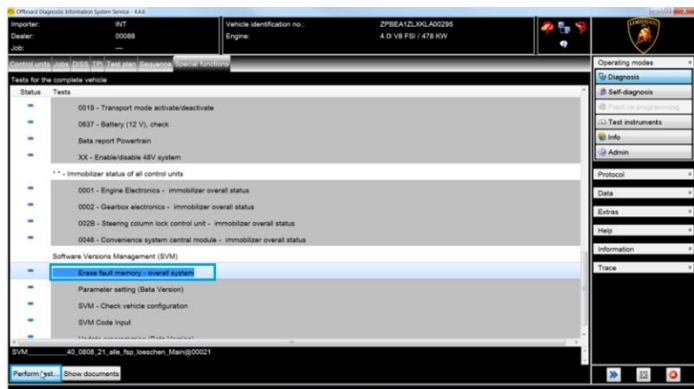

The complete guide for deleting faults is available in the workshop manual, chapter **"10.00.B-Deleting the data in the fault memory of control units"**.

37. Go back to the "Block diagram" card and select "Read all fault memories" from one of the vehicle's control units in order to update the display of the faults present after deletion.



IMPORTANT:
Solve any faults still present by performing the functions listed in the "Test plan". Perform the procedure "II. Fault memory deletion" again until all faults are fully removed from the vehicle's control units.

/* Diagnosis protocol saving */

38. Save the Diagnostic protocol as described in the chapter **"10.00.H-Saving the diagnostic protocol"** when the procedure described in this document is completed.



IMPORTANT:

The Diagnostic Protocol must be attached to the Corresponding Warranty Request (to enter the request on the web portal, refer to the W.Claim manual which you can consult in the Warranty section of the portal).

Trouble shooting:

- i. If the following error screen is displayed, abort the guided function by clicking on "Cancel Test" and contact Technical Support.



- ii. If an error is displayed that regards the hardware interface, and the "connection to vehicle" and "key state" icons appear as shown in the figure below:

- Click "Cancel";
- Repeat installation of the interface VAS5054/6154/6154A for the instructions in procedure (*)"VCI Manager v2.0", selecting the right-hand "Extras" menu in ODIS and clicking on the "Diagnostic interface" button.

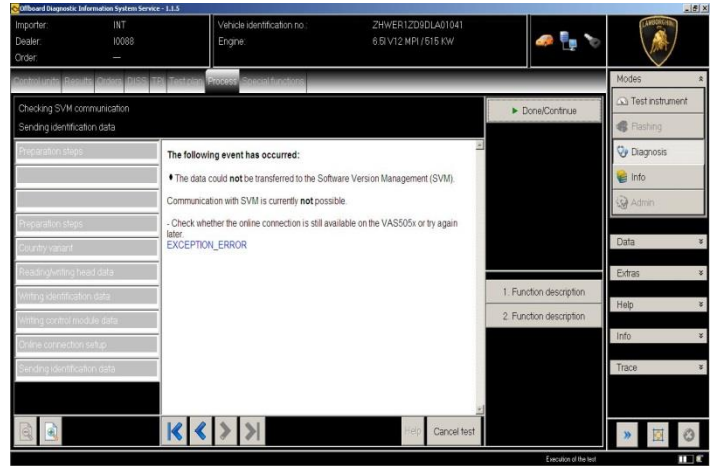

iii. If one of the following connection errors is displayed like in the following example screenshots:

- It is not possible to connect to the central server; check that your laptop is correctly connected to the Internet and retry by clicking on "Yes" or "Done/continue", as appropriate.

iv. If the connection is dropped during the course of the target/actual comparison during the SVM procedure:

- It is not possible to connect to the central server; check that your laptop is correctly connected to the Internet and retry by clicking on "1".

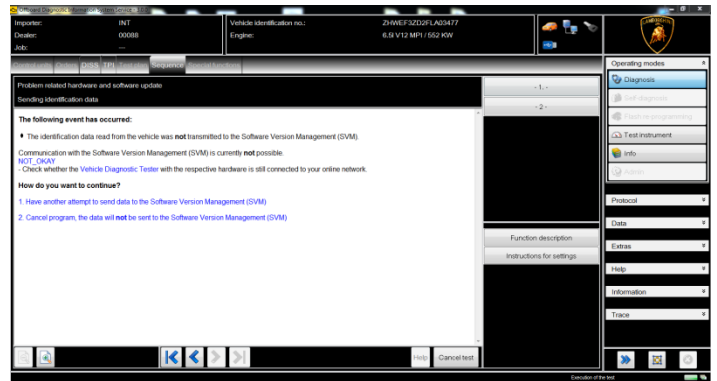
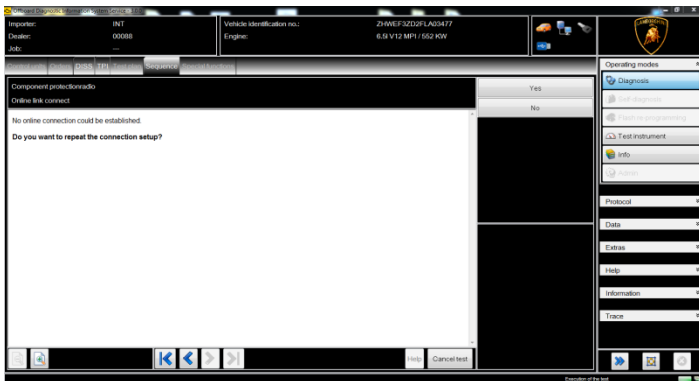

v. If the authentication error as shown in the following screenshot is displayed (error code: ODS1007E):

- Ensure you have a valid GeKo user account
- Ensure that the "GeKo" label is printed on the token you are using
- Ensure you have entered the correct password



- Click on "Cancel" and run the application test (see document "ODIS_ControlloConnessione_Server_SVM_2.0" (*)).

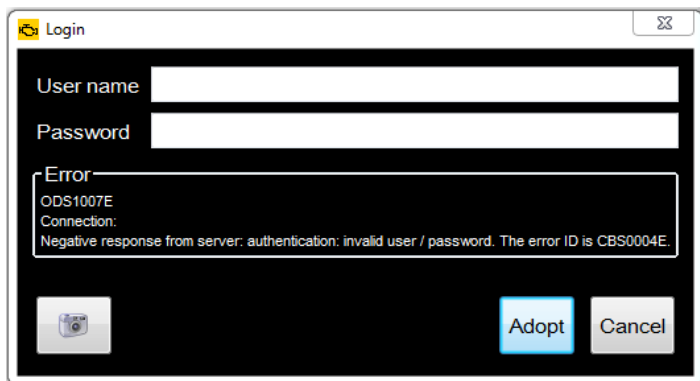

- vi. If the infrastructure error as shown in the following screenshot is displayed (error code: ODS9212E):

- Ensure you have a valid GeKo user account
- Ensure that the "GeKo" label is printed on the token you are using
- Check that the Internet is set in ODIS settings and not CPN (see document "Setup_Iniziale_ODIS_7.0" (*))
- Click on "Cancel" and run the application test (see document "ODIS_ControlloConnessione_Server_SVM_7.0" (*)).

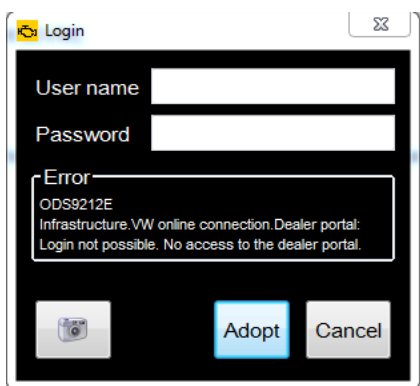

- vii. If the same error type should reoccur during the application test, try the following procedure:

- Exit ODIS
- Browse to the folder C:\Program Data\Offboard_Diagnostic_Information_System_Service\automatic_sessions on your diagnostic laptop
- Delete the only file which will be in the folder
- Restart ODIS Service, ensuring that:
 1. You have a network connection
 2. The ODIS connection is set to Internet
- Run the connection test again, and perform the SVM again with your GeKo Token.



IMPORTANT:

If the error occurs again, repeat the procedure and try with a second GeKo token, if available.

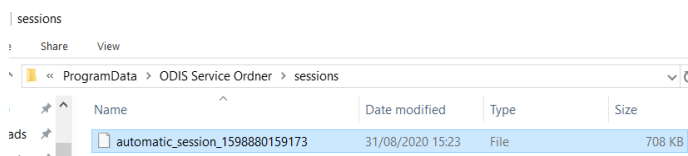

- viii. If the following error should occur, it is necessary to follow the instructions given in **BI.25.18** (Rev.02), which can be downloaded on the Lamborghini HUB portal:

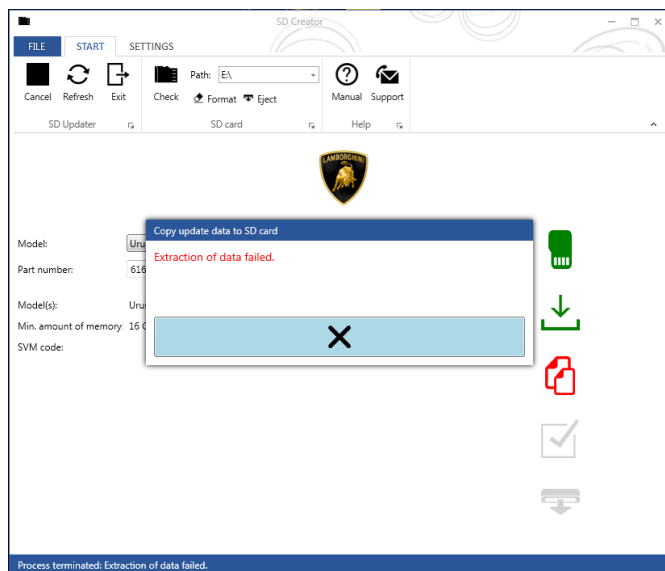

NOTE. (*)

All ODIS technical documentation can be viewed on the Lamborghini web portal, in the corresponding ODIS section.



IMPORTANT:

The documents which must be provided with the warranty request are:

- Produced Repair Order
- Saved Diagnostic Protocol and Beta Report

Failure to follow these procedures could lead to the request being rejected.