



## CR212 - Rear Brake Hose Replacement

Monster 797 Model Year 2017-2020 (USA-CAN only)  
Safety Recall Campaign SRV-RCL-21-005

Date: June 9, 2021  
To: Dealer Principal, General Manager, Service Manager, North American Dealer Network  
From: Richard Kenton, Technical Director  
Eric Bradley, Technical Training and Publications Manager

Dear Dealers,

Ongoing product quality testing and field reports have identified a potential for the rear brake application to soften over time as a consequence of use. To correct cases of this occurrence, new rear brake hoses (ABS control unit to rear brake master cylinder – yellow, and ABS control unit to rear brake caliper - blue) will be installed for the above listed model.

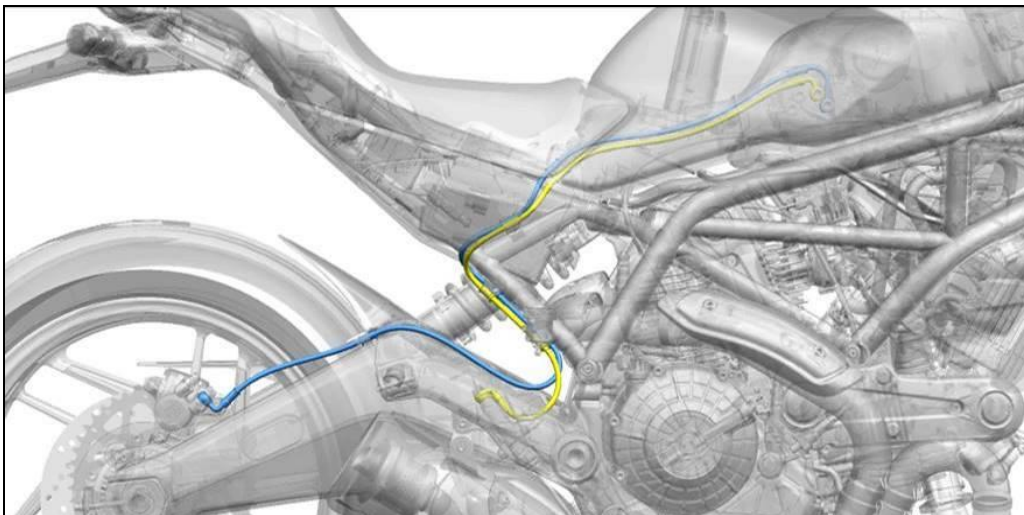

### NOTE

All Monster 797 model versions currently produced and being shipped by DMH to all destinations have already been equipped with these new brake hoses



# CR212 - Rear Brake Hose Replacement

Monster 797 Model Year 2017-2020 (USA-CAN only)  
Safety Recall Campaign SRV-RCL-21-005

## Application

You can find the precise list of VIN numbers involved in CR212 on the DCS, in sections:

VIN HISTORY		It is possible to search by individual frame number.
CAMPAIGNS		It is possible to search for all the frame numbers that you received from Ducati Motor Holding.

MONSTER 797 RED 2020 CAL DMT					
VIN #	ML0MADB2LT00 XXX	ENGINE #	ADBL9 XXX	LAST MILEAGE OPERATION	0 MI
END CUSTOMER	Corsa Moto Transport, Inc.	MANUFACT DATE	01/18/2020	INVOICE	03/18/2020
WARRANTY TYPE		STANDARD WTY START DATE		WTY END DATE	
SERVICE STATUS					

**ATTENTION: YOU HAVE 1 PENDING RECALL CAMPAIGNS**

N	TYPE	ID NUMBER	REPAIR DATE	DEFECT	CAUSAL PART	DEALER	MILEAGE
1	RECALL	<a href="#">CR212</a>		SRV-TSB-21-005 repl rear brake hose	Rear Brake Hose	<input type="button" value="VIEW"/> <input type="button" value="APPLY"/>	

## Customer Impact

All motorcycles in your inventory (to be registered or already registered) and to be delivered to final Customers must be updated during pre-delivery operations and always before delivery to the final Customer. All motorcycles already delivered to final Customers must undergo this inspection as soon as they come to your workshop.

## Parts Distribution

The following components required to carry out the upgrade under this Safety Recall Campaign must be ordered for each affected frame number.

- 61911491A: ABS control unit / rear brake master cylinder hose
- 61911481A: ABS control unit / rear brake caliper hose
- 85250241A: Copper washers (8pcs)

The required self-locking ties (small (2 pcs) and large (4 pcs)) are easy to find consumables and should be sourced locally.

## Warranty Reimbursement Rules

Reimbursement for work associated with this Safety Recall Campaign will be made through the regular warranty claim procedure using the "Vehicle History" section of the DCS.



# CR212 - Rear Brake Hose Replacement

Monster 797 Model Year 2017-2020 (USA-CAN only)  
Safety Recall Campaign SRV-RCL-21-005

The warranty claim is pre-filled and is identified as CR212.

The dealer shall be reimbursed for the parts listed for the operation; copper washers (8) part no. 85250241A, ABS control unit / rear brake master cylinder hose Part no. 61911491A, ABS control unit / rear brake caliper hose Part no. 61911481A, the consumable ties and DOT 4 brake fluid; and labor for **1h:30min (15 labor units)** that includes the time necessary for:

- Vehicle reception
- Rear brake hose removal (ABS control unit / brake master cylinder and ABS control unit / brake caliper)
- Installation of new rear brake hose assembly (ABS control unit / brake master cylinder and ABS control unit / brake caliper)
- Filling and bleeding procedure of the rear brake system
- Soft cleaning of the vehicle

## Table of contents



	Page
Introduction	1
Application	2
Customer Impact	2
Parts Distribution	2
Warranty Reimbursement Rules	2
Spare Parts	4
Service Solution – Rear Brake Line Replacement	4
Part 1: Vehicle Preparation	4
Part 2: Rear Brake Hose Removal	6
Part 3: New rear brake hose installation	9
Part 4: Rear brake system filling and bleeding	15
Part 5: Vehicle Refitting	16
Additional Requirements and Notes	19
Customer Letter Example	20



## CR212 - Rear Brake Hose Replacement

Monster 797 Model Year 2017-2020 (USA-CAN only)  
Safety Recall Campaign SRV-RCL-21-005

### Spare Parts

Part No.	Description	Picture
61911491A	ABS control unit / rear brake master cylinder hose	
61911481A	ABS control unit / rear brake caliper hose	
85250241A	Copper washers (8pcs)	

### Service Solution



#### WARNING

To ensure the correct execution of the operation within the provided labor time to carry out the updates, it is necessary to follow the sequence indicated in the following instructions

### Rear Brake Line Replacement

#### Part 1: Vehicle preparation

1. Position the bike on the rear paddock stand
2. Drain all the oil contained inside the rear brake system



#### WARNING

Brake fluid may damage the paint or parts of the motorcycle. Wash the affected area with plenty of water in case of accidental contact. Damage due to brake fluid spillage is not a warrantable defect and is the responsibility of the repairing dealer to correct



## CR212 - Rear Brake Hose Replacement

Monster 797 Model Year 2017-2020 (USA-CAN only)  
Safety Recall Campaign SRV-RCL-21-005

3. Remove the seat
4. Remove the fuel tank (See Sec.8: "Supply/exhaust system/Fuel tank" of the Workshop Manual)
5. Working on vehicle RH side, remove:
  - the 2 M5x12 screws (1) securing the cover (2) to the rear subframe
  - the M5x9 screw (3) securing the cover (2) to the rear central cover
6. Slide out cover (2) by releasing the 2 pins (4) from the relevant seats (5)

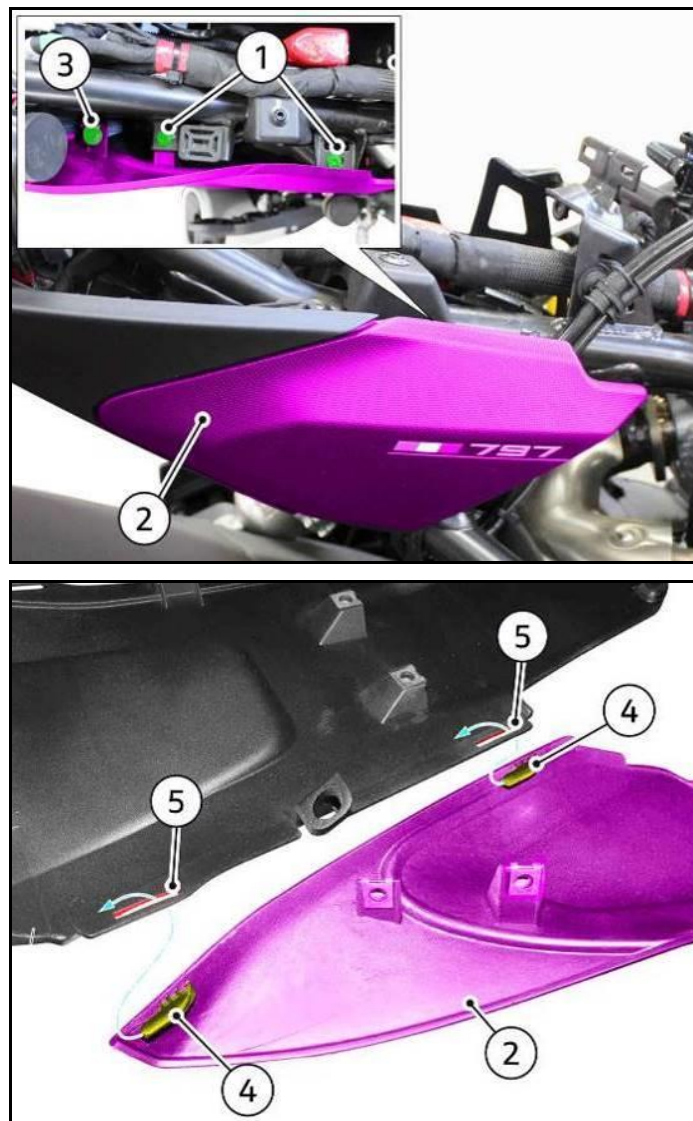



## CR212 - Rear Brake Hose Replacement

Monster 797 Model Year 2017-2020 (USA-CAN only)  
Safety Recall Campaign SRV-RCL-21-005

### Part 2: Rear brake hose removal



#### WARNING

Brake fluid may damage the paint or parts of the motorcycle. Wash the affected area with plenty of water in case of accidental contact. Damage due to brake fluid spillage is not a warrantable defect and is the responsibility of the repairing dealer to correct

1. Release the **hose (6)** connecting the ABS control unit to the rear brake caliper from:
  - the **5 fast points (7)** connecting the brake caliper hose to the rear speed sensor cable
  - the small self-locking **tie (8)** connecting the brake caliper hose to the rear speed sensor cable
  - the small self-locking **tie (9)** connecting the **caliper hose (6)** and the rear **brake master cylinder hose (10)** to the rear brake switch cable, the rear wheel speed sensor cable and the neutral switch cable

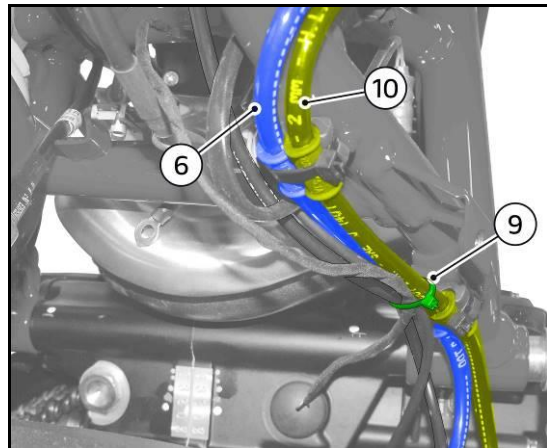
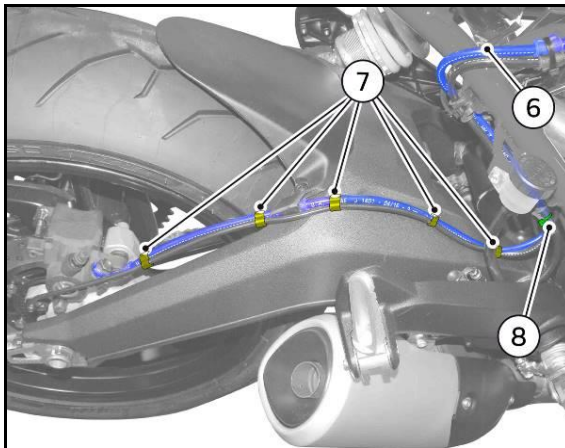

#### NOTE

To facilitate the removal of the tie (8) it is possible to remove the **tank (11)** for the rear brake oil by removal of the retaining **screw M6x10 (12)**

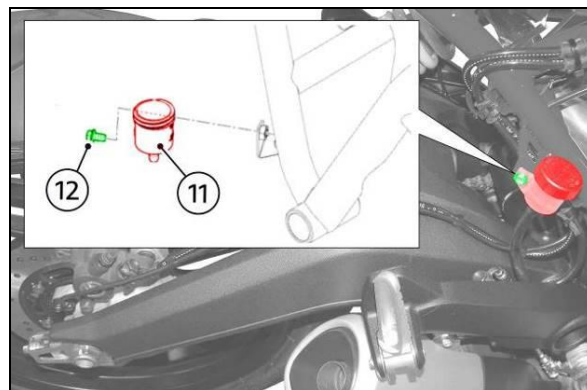



## CR212 - Rear Brake Hose Replacement Monster 797 Model Year 2017-2020 (USA-CAN only) Safety Recall Campaign SRV-RCL-21-005

- The 4 big self-locking ties (13) connecting the caliper hose (6) and the rear brake master cylinder hose (10) to the relevant rubber guides on the frame

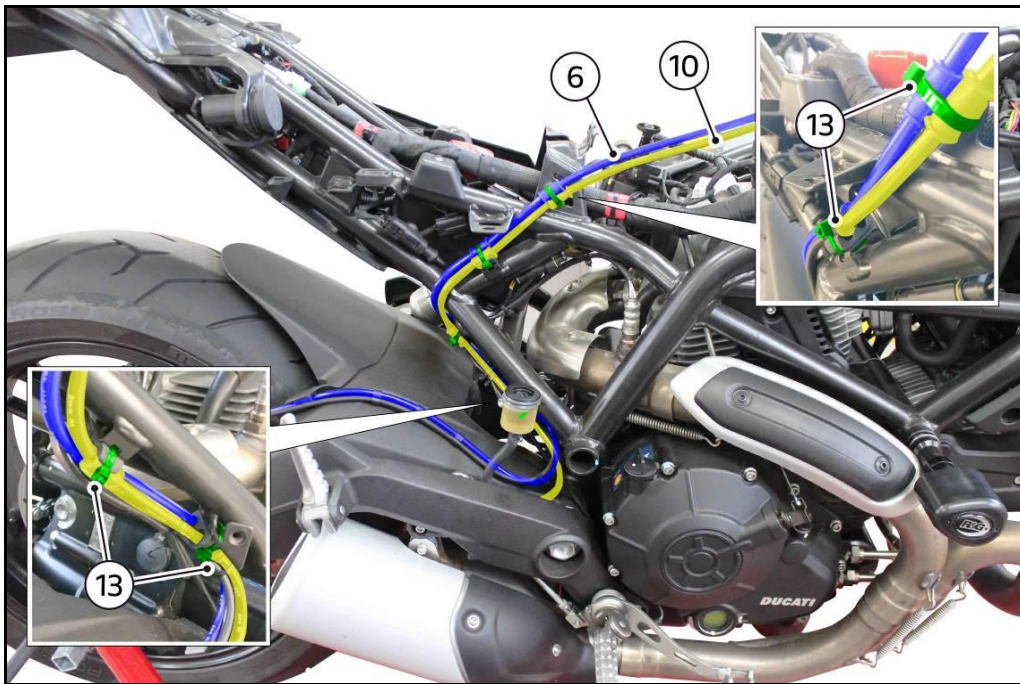

2. Remove the special screw (14) with the 2 copper washers (15) securing brake hose (10) to rear brake master cylinder
3. Remove the special screw (16) with the 2 copper washers (17) securing brake hose (10) to the ABS control unit

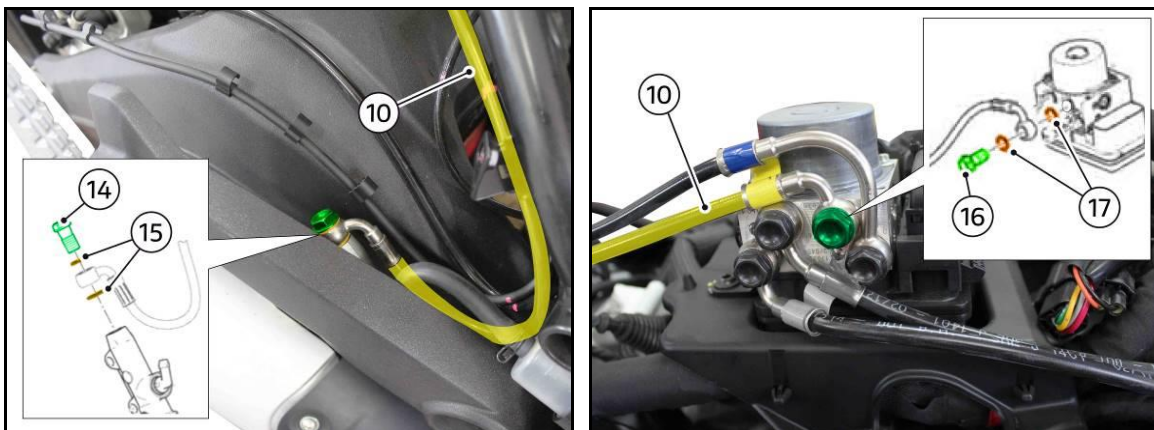



## CR212 - Rear Brake Hose Replacement

Monster 797 Model Year 2017-2020 (USA-CAN only)  
Safety Recall Campaign SRV-RCL-21-005

4. Remove the **hose (10)** connecting the rear brake master cylinder to the ABS control unit

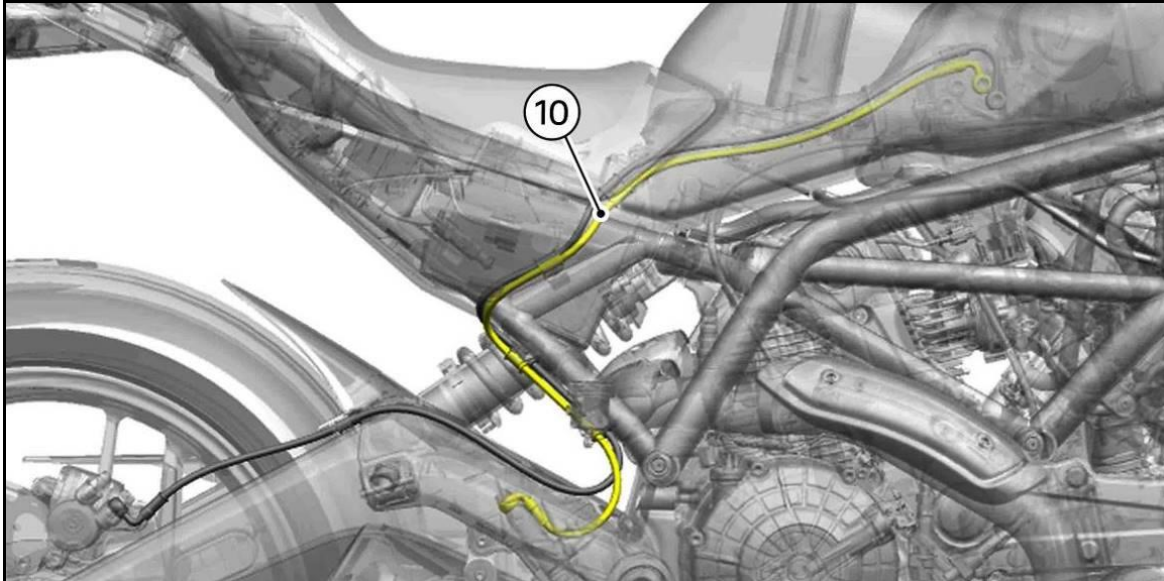

5. Remove the **special screw (18)** with the **2 copper washers (19)** securing **hose (6)** to the ABS control unit
6. Remove the **special screw (20)** with the **2 copper washers (21)** securing the **hose (6)** to rear brake caliper

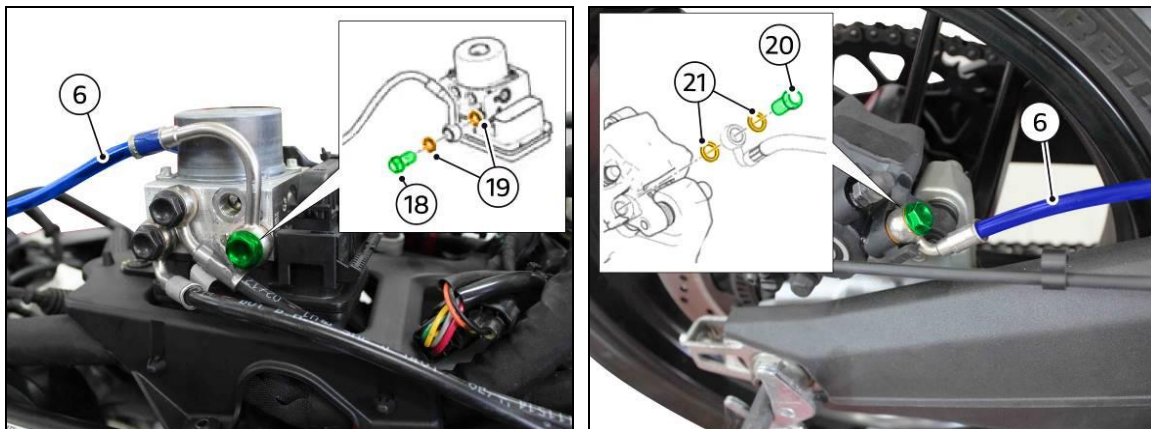





## CR212 - Rear Brake Hose Replacement

Monster 797 Model Year 2017-2020 (USA-CAN only)  
Safety Recall Campaign SRV-RCL-21-005

7. Remove Pull out the **hose (6)** connecting the rear brake caliper to the ABS control unit

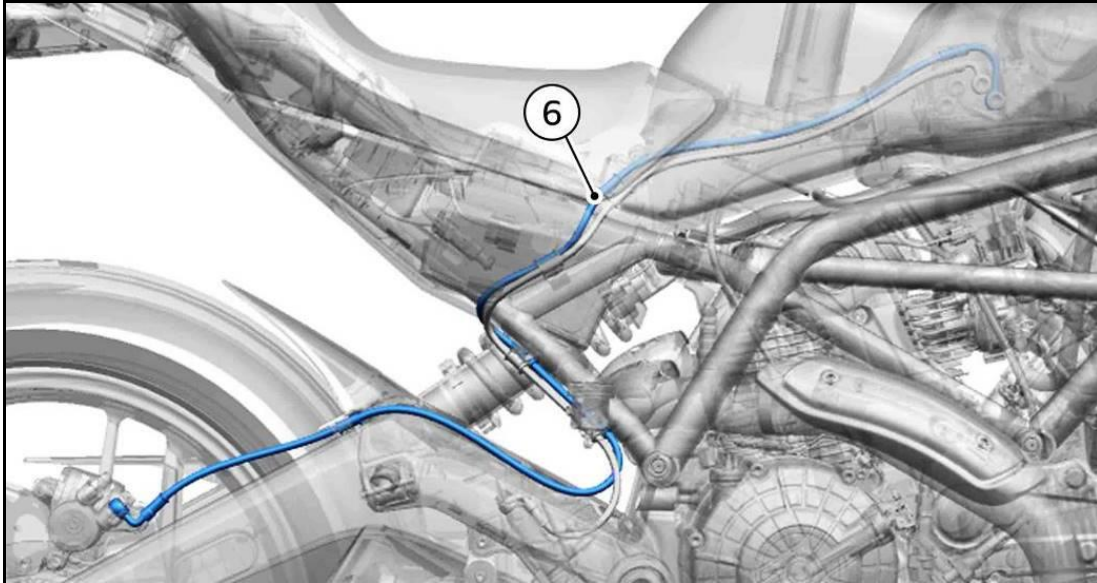

### Part 3: New rear brake hose installation

1. Take the new **brake hose (A)** connecting the ABS control unit to the rear brake caliper



#### NOTE

The new brake hose can be recognized by the different chamfering that characterizes the end part of the fittings





## CR212 - Rear Brake Hose Replacement

Monster 797 Model Year 2017-2020 (USA-CAN only)  
Safety Recall Campaign SRV-RCL-21-005

2. Install the new **hose (A)** connecting the ABS control unit to the rear brake caliper on the vehicle, as shown in the figure

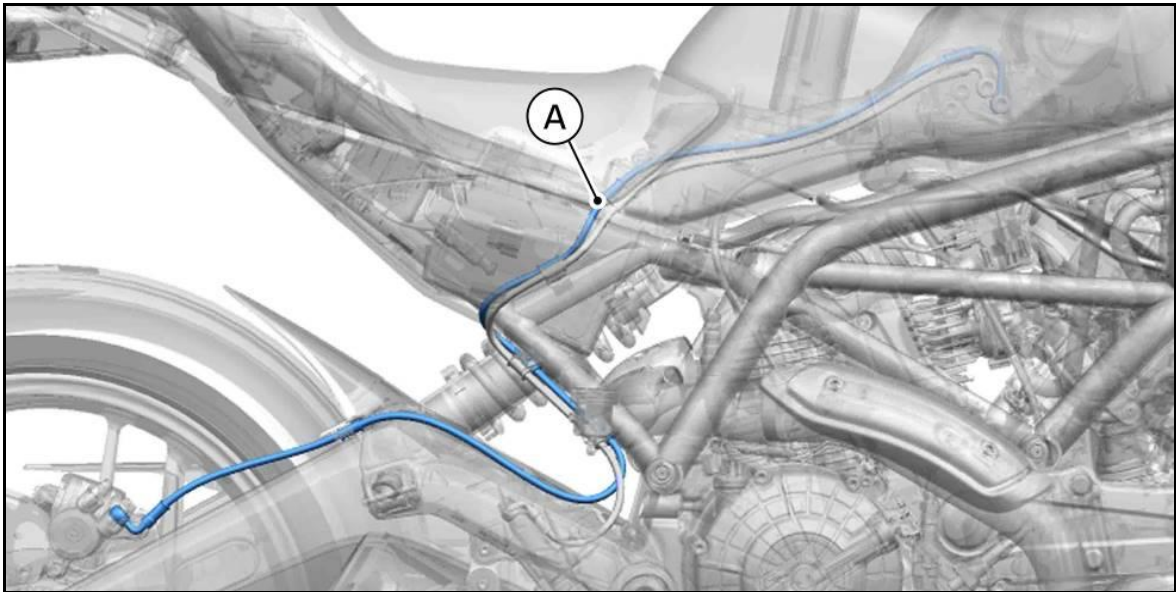

3. Fasten the ABS control unit fitting to the control unit as shown in the figure, using **2 new copper washers (B)** and tighten the **special screw (18)** to **25 Nm ± 5% with certification**
4. Fasten the rear brake caliper fitting, aiming it as shown in the figure, using **2 new copper washers (C)** and tighten the **special screw (20)** to **25 Nm ± 5% with certification**

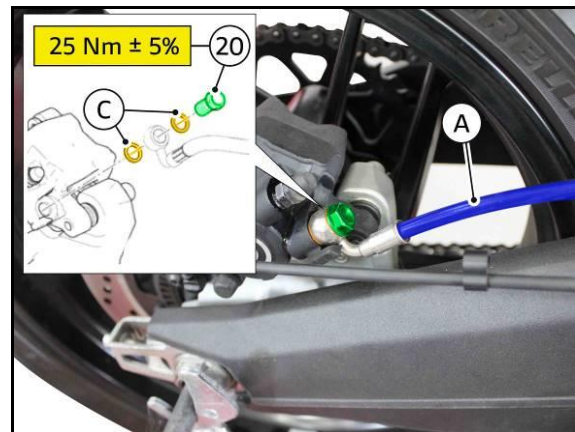
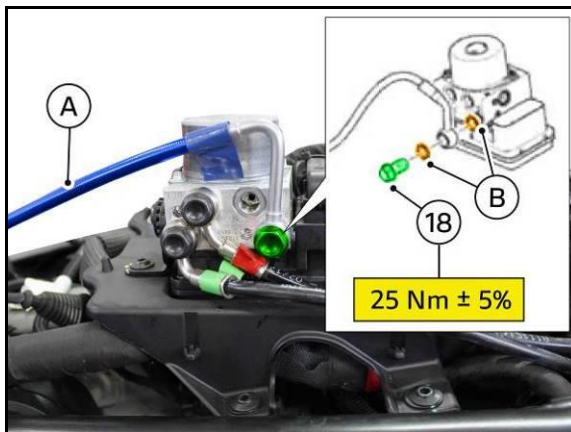



## CR212 - Rear Brake Hose Replacement

Monster 797 Model Year 2017-2020 (USA-CAN only)  
Safety Recall Campaign SRV-RCL-21-005

5. Take the new **brake hose (D)** connecting the ABS control unit to the rear brake master cylinder



### NOTE

The new brake hose can be recognized by the different chamfering that characterizes the end part of the fittings

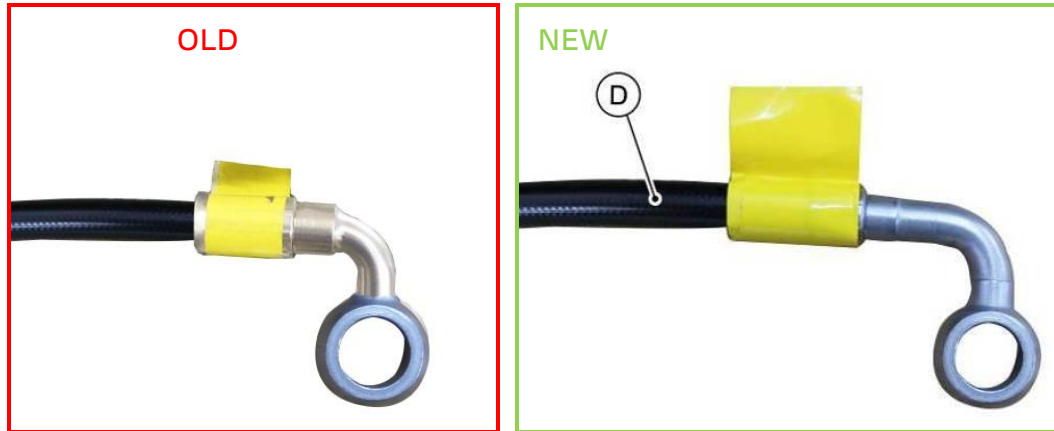

6. Install the new **hose (D)** connecting the ABS control unit to the rear brake master cylinder on the vehicle, as shown in the figure

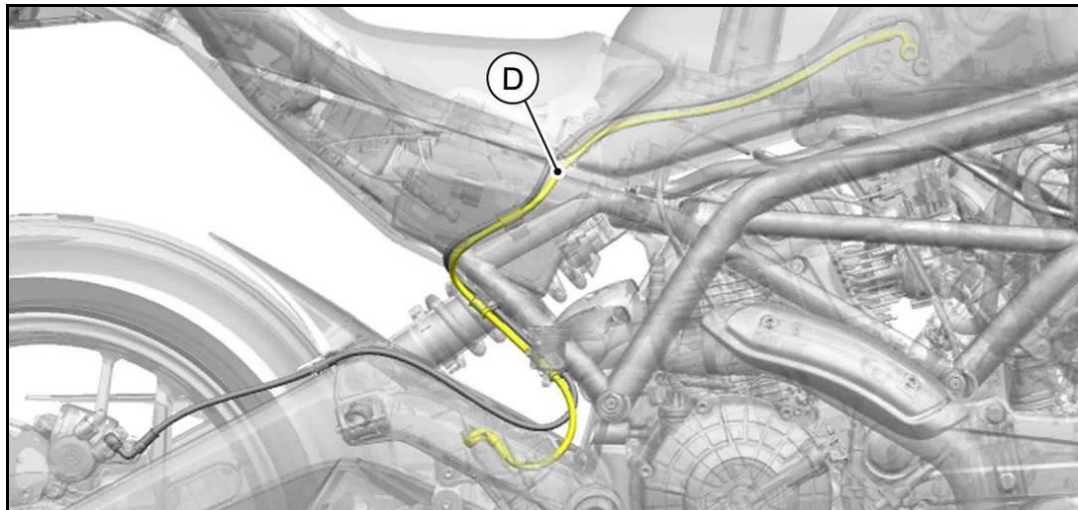



## CR212 - Rear Brake Hose Replacement

Monster 797 Model Year 2017-2020 (USA-CAN only)  
Safety Recall Campaign SRV-RCL-21-005

7. Fasten the ABS control unit fitting to the control unit as shown in the figure, using **2 new copper washers (E)** and tighten the **special screw (16)** to **25 Nm ± 5% with certification**
8. Fasten the rear brake master cylinder fitting, aiming it as shown in the figure, using **2 new copper washers (F)** and tighten the **special screw (14)** to **25 Nm ± 5% with certification**

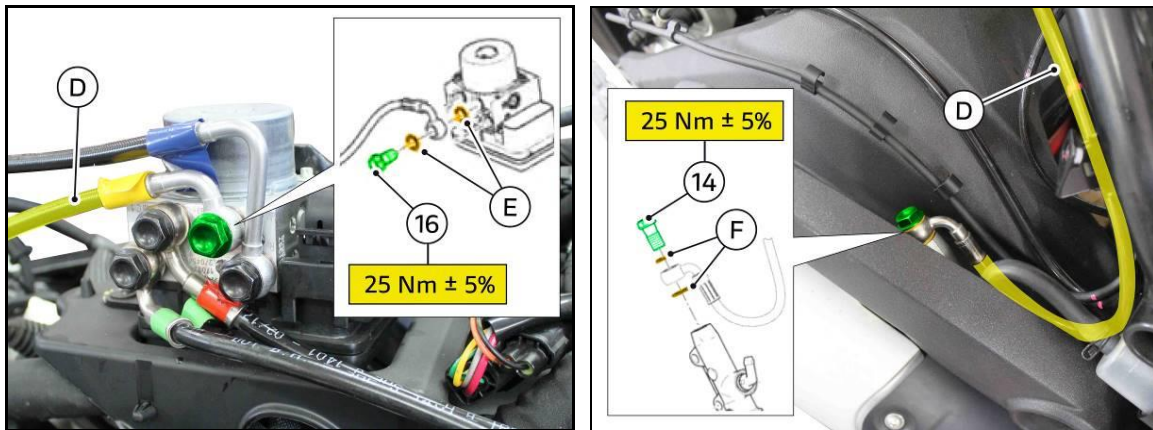

### WARNING

Make sure that **brake hose (A)** and **brake hose (D)** fittings are aimed on the ABS control unit as shown in the figure and check also that there are no interferences

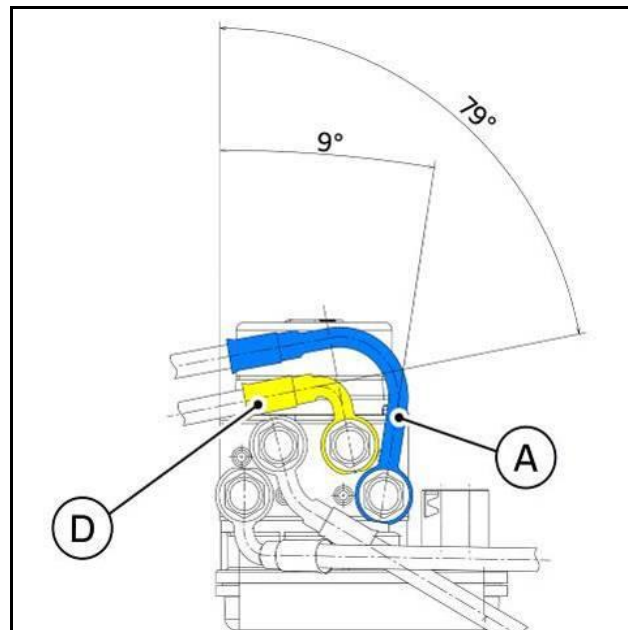



## CR212 - Rear Brake Hose Replacement

Monster 797 Model Year 2017-2020 (USA-CAN only)  
Safety Recall Campaign SRV-RCL-21-005



### WARNING

Make sure that the **brake hose (A)** fitting is aimed on the rear brake caliper as shown in the figure and is fully home on **plate (21)** of the caliper holder plate.

Make sure the **brake hose (D)** fitting is aimed on the rear brake master cylinder as shown in the figure

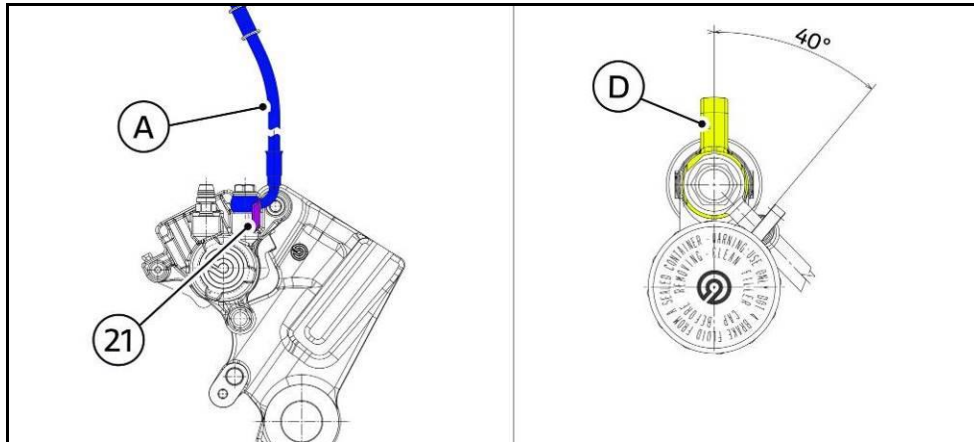

9. Slide the new hoses (A) and (D) inside the 4 rubber guides on the frame by positioning them as shown in the figure and fixing them with 4 new big self-locking ties (22)

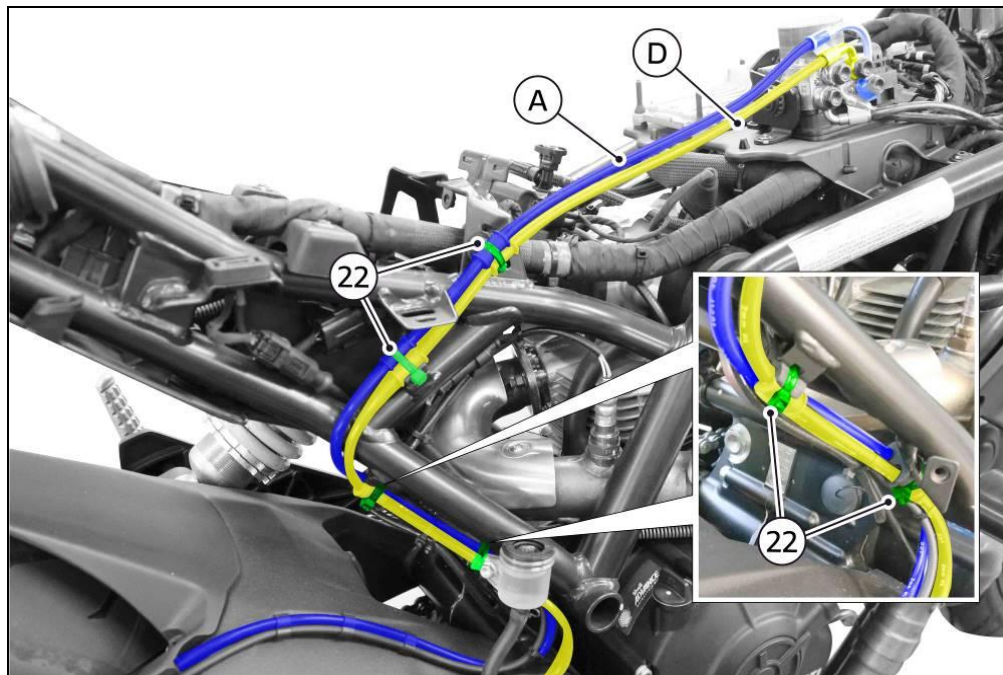



## CR212 - Rear Brake Hose Replacement

Monster 797 Model Year 2017-2020 (USA-CAN only)  
Safety Recall Campaign SRV-RCL-21-005



### NOTE

In case of rear brake oil **tank (11)** removal, proceed with the installation as shown in the figure. Tighten the retaining **screw M6x10 (12)** to **2 Nm ± 10%**

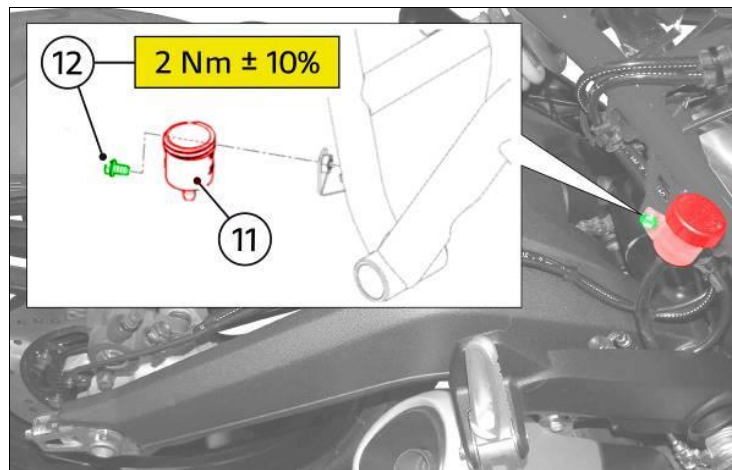

10. Install the new small self-locking **tie (23)** connecting the **caliper hose (A)** and the rear brake **master cylinder hose (D)** to the rear brake switch cable, the rear wheel speed sensor cable and the neutral switch cable as shown in the figure.
11. Install the new small self-locking **tie (24)** connecting the rear brake caliper hose to the rear speed sensor cable as shown in the figure.
12. Connect the **hose (A)** to the rear speed sensor cable using the **5 fast points (6)** as shown in the figure.

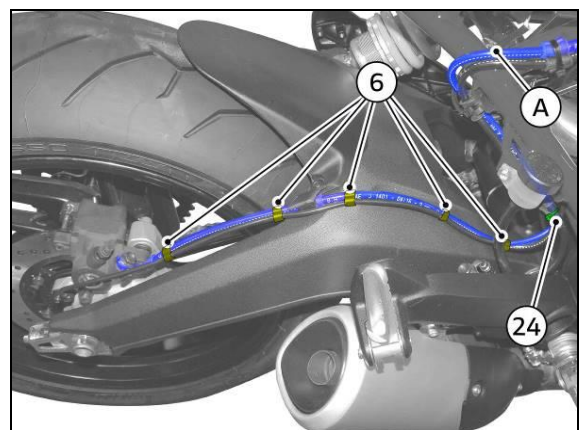
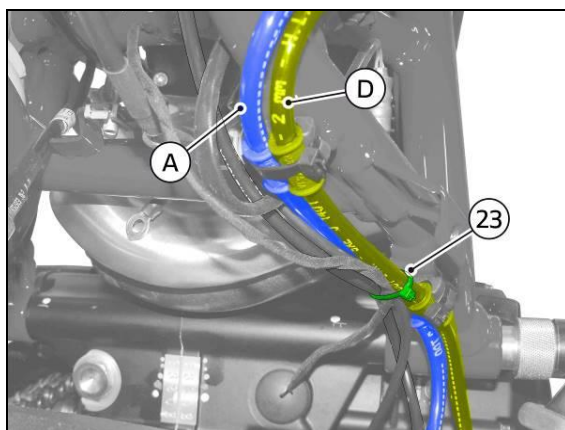



## CR212 - Rear Brake Hose Replacement

Monster 797 Model Year 2017-2020 (USA-CAN only)  
Safety Recall Campaign SRV-RCL-21-005



### NOTE

Make sure the **rubber seal (25)** on **hose (A)** is correctly inserted into the relevant seat on the rear mudguard, otherwise move the rubber seal in order to properly insert it.

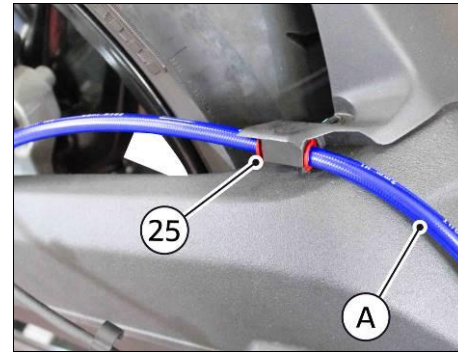
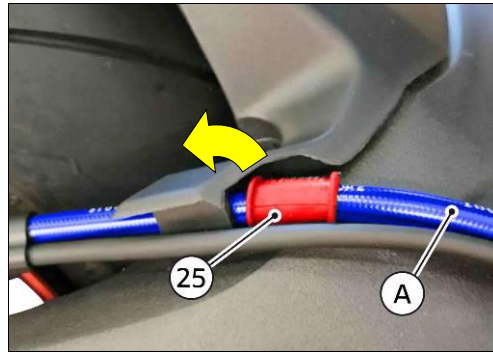

### Part 4: Rear brake system filling and bleeding

1. Proceed with the DOT4 fluid filling inside the rear brake system and bleed the system following the procedure indicated for the Monster family.



### WARNING

Remember, brake fluid can damage the paint or parts of the motorcycle. Wash the affected area with plenty of water in case of accidental contact

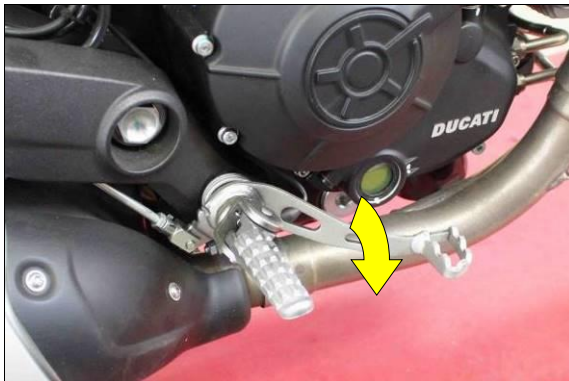



## CR212 - Rear Brake Hose Replacement

Monster 797 Model Year 2017-2020 (USA-CAN only)  
Safety Recall Campaign SRV-RCL-21-005

### Part 5: Vehicle Refitting

1. By working on the right side of the vehicle, install the **cover (2)** by inserting the **2 pins (3)** in the relevant **seats (4)**
2. Tighten the **2 M5x12 screws (1)** securing the **cover (2)** to the rear subframe to **5 Nm ±10%**
3. Tighten the **M5x9 screw (3)** that retains the **cover (2)** to the rear central cover to **3.5 Nm ± 10%**

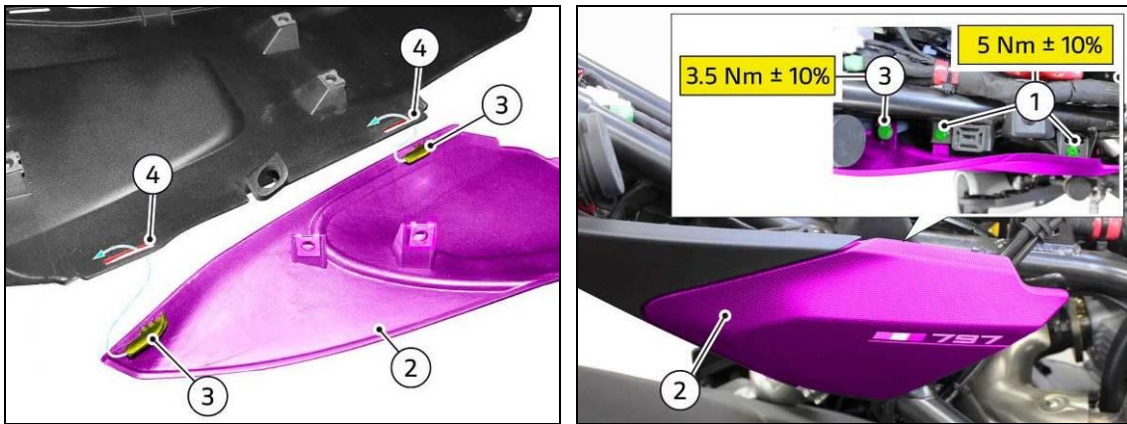

4. Fit the fuel tank (see Sec.8: "Supply/exhaust system/Fuel tank" of the Workshop Manual)
5. Fit the seat
6. Start the engine and keep it at idle until reaching the normal operating temperature
7. Connect the DDS 2.0 or DDS 3.0 diagnosis instrument and run a Global Scan





## CR212 - Rear Brake Hose Replacement

Monster 797 Model Year 2017-2020 (USA-CAN only)  
Safety Recall Campaign SRV-RCL-21-005



### WARNING

Before measuring the heights (A) and (B) for the brake pedal travel check, always check that the free play travel of the rear brake lever is correct (between 2 mm to 5 mm)

Remember that the idle stroke refers to the stroke performed by the brake cylinder control rod before operating the pump. If the idle stroke is outside the specified values, it must be adjusted again using the adjustment screw on the control rod

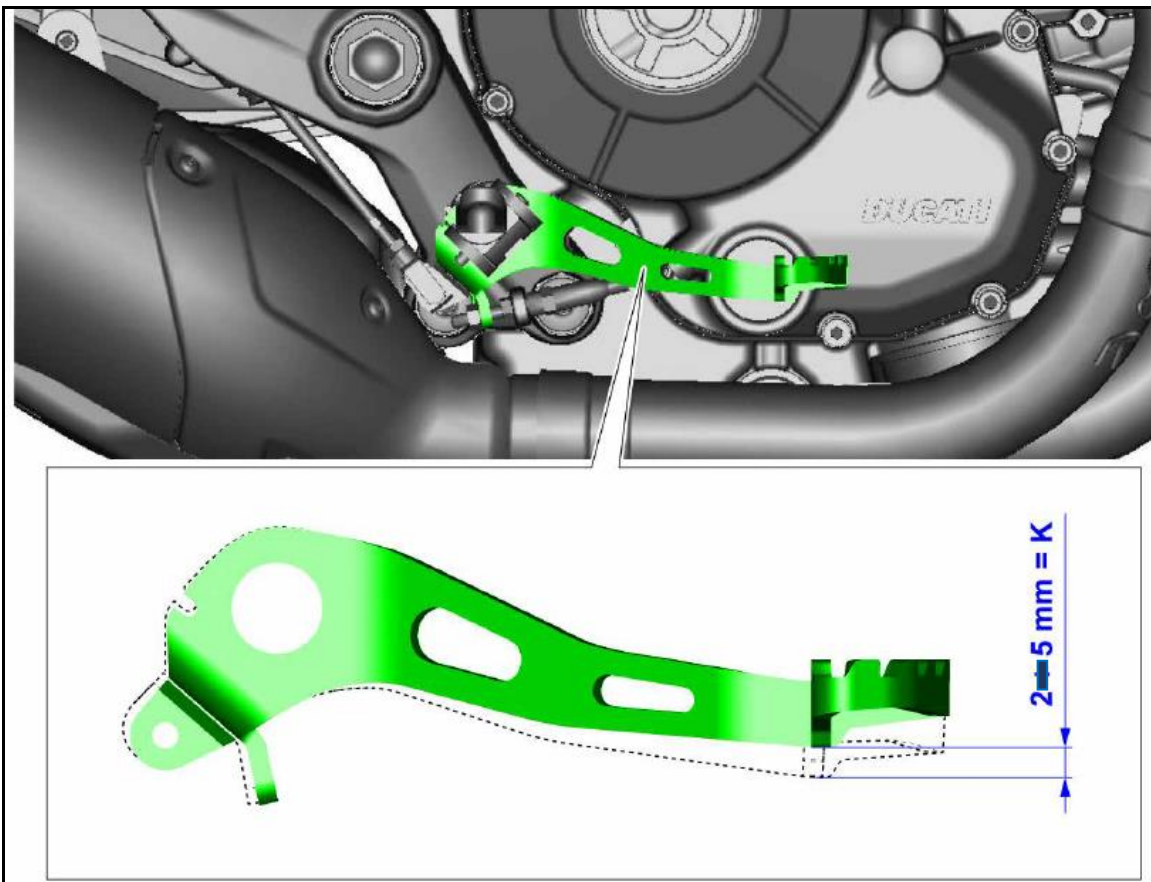



## CR212 - Rear Brake Hose Replacement Monster 797 Model Year 2017-2020 (USA-CAN only) Safety Recall Campaign SRV-RCL-21-005

8. Measure height **(A)** between rear brake lever lower end and load-bearing surface; brake lever must be in rest position (upper limit stop)
9. Slowly position the 8 kg weight onto rear brake lever; then measure height **(B)** between rear brake lever lower end and load-bearing surface

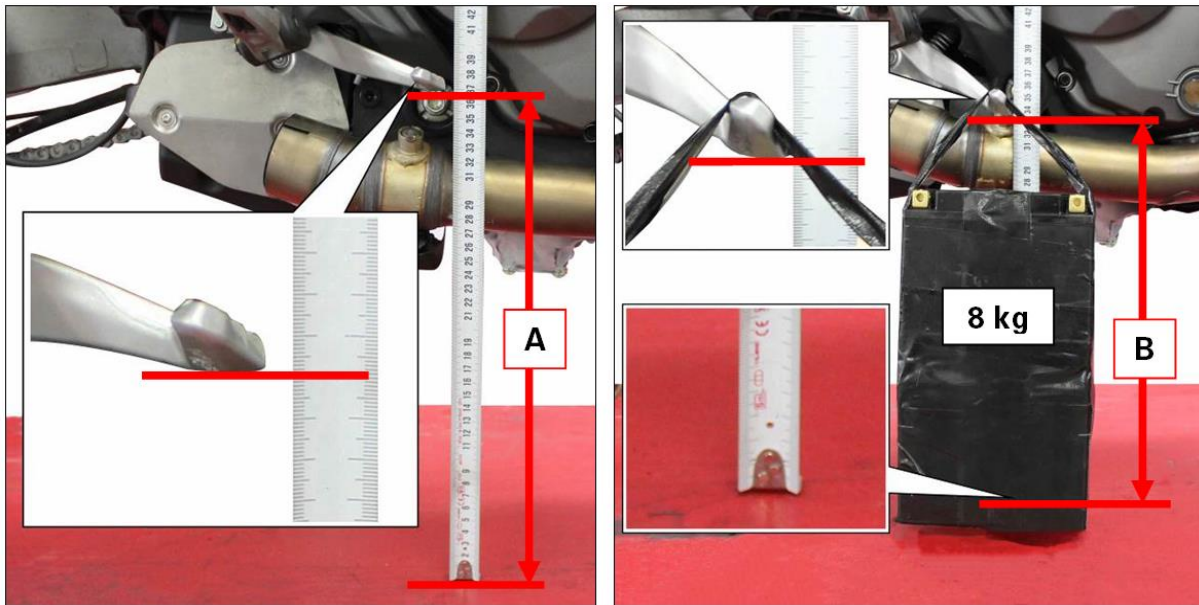

10. Note the difference between the measured heights **(A1)** and **(B1)**

$$\text{Rear brake lever stroke 1} = (A1) - (B1)$$

11. Road test the vehicle on the road at a speed of about 30 mph (50 Km/h) and, by operating only the rear brake, brake until the **ABS is engaged at least 10 times**
12. Measure again the rear brake lever stroke as referred to in steps 8 and 9
13. Note the difference between the measured heights **(A2)** and **(B2)**

$$\text{Rear brake lever stroke 2} = (A2) - (B2)$$

14. Compare the 2 stroke values of the rear brake lever
15. If the difference between the measured heights **(A)** and **(B)** is equal to or below 23 mm, no further action is required
16. If the difference between the measured heights **(A)** and **(B)** is greater than 23 mm, repeat the complete bleed procedure
17. Perform a soft cleaning of the bike before delivering it to the Customer



## **CR212 - Rear Brake Hose Replacement**

Monster 797 Model Year 2017-2020 (USA-CAN only)  
Safety Recall Campaign SRV-RCL-21-005

### **Campaign Authorization**

Ducati North America, Inc. will mail a notification letter to all known owners. If a customer does not present this notification letter, it is important that you confirm the eligibility for recall status on the DCS before you commence work. Reimbursement requests for duplicate recall campaign repairs will not be accepted.

### **Dealer Obligation**

This program is designed to complete the necessary repairs and to achieve owner satisfaction. Therefore, we ask that you to take prompt and courteous action in accordance with these directives. Please provide a copy of this communication to every person in your dealership who has recall-related responsibilities. Please direct any questions or concerns to your Service Area Manager.

Thank you for your cooperation.

Service Department  
Ducati North America, Inc.

For questions on this Safety Recall Campaign,  
please contact your Service Area Manager.



**CR212 - Rear Brake Hose Replacement**  
Monster 797 Model Year 2017-2020 (USA-CAN only)  
Safety Recall Campaign SRV-RCL-21-005

**IMPORTANT SAFETY RECALL**

This notice applies to your vehicle: VIN XXXXXXXXXXXXXXXXXXXX

[NHTSA Recall No. 21V-21V-315](#)

June 9, 2021

Customer Name  
Customer Address  
City, St, Zip Code

**Subject:**

**Ducati Motorcycle: Monster 797 MY 2017-2019 all model versions (USA and CAN only)**

NHTSA Campaign I.D. Number: 21V-21V-315

**Dealer Bulletin: SRV-RCL-21-005**

Dear Ducati Owner,

This notice is sent to you in accordance with the requirements of the U.S. National Traffic and Motor Vehicle Safety Act. Ducati Motor Holding S.P.A. has decided that a defect which relates to motor vehicle safety exists in certain Monster 797 MY 2017-2019 all model versions (USA and CAN only). Our records indicate that you are the owner of a Ducati motorcycle affected by this safety recall campaign. Please take the time to read this letter and help us take the appropriate steps to ensure that your vehicle is operating properly.

**What is wrong?**

It has been determined that due to brake system architecture, there is a potential for greater susceptibility for air permeation through the rear brake hoses into the rear brake system, reducing rear brake effectiveness. If this issue develops during normal use, it develops gradually, providing sufficient warning to the operator that rear braking performance may be degrading. If this issue develops after long periods of time without using the motorcycle, the rider during the pre-ride check (as recommended in the Owner's manual) would be warned by an increase of the rear brake pedal stroke. If this condition remains undetected, a rider who relies on rear braking may experience extended stopping distances, increasing the risk of a crash.

The front and rear brake system for this motorcycle are hydraulically independent; therefore, performance of the front brake, which provides full stopping ability, is NOT affected by the rear brake system.



## CR212 - Rear Brake Hose Replacement

Monster 797 Model Year 2017-2020 (USA-CAN only)  
Safety Recall Campaign SRV-RCL-21-005

### What will Ducati do?

An official Ducati dealer will replace the rear brake hoses, free of charge. The repair will take approximately 1.5 hours to complete. Service time will vary depending on dealer scheduling.

Please contact your local Ducati Service center as soon as possible to schedule an appointment for the repair. You may continue to operate your motorcycle to reach your Ducati authorized dealer. If your rear brake system is inoperable, or if you feel uncomfortable riding the motorcycle, please discontinue operating the vehicle, then contact our roadside assistance provider at 800-234-1353 to facilitate a tow service to your nearest Ducati dealer.

To locate your nearest authorized Ducati dealer, please go to [www.ducati.com](http://www.ducati.com), and select the "dealer locator" or you may call toll free from the U.S. 1-888-391-5446.

Federal regulations require that any lessor receiving this recall notice must forward a copy of this notice to the lessee within ten days.

### Service Problem Help:

If you believe that your dealer has failed or is unable to remedy the defect without charge, or within a reasonable period of time, please contact Ducati North America Customer Care at 1 (888) 391-5446.

If you cannot obtain satisfaction, please use the following options:

### For USA Customers:

If you are still having difficulty getting your vehicle repaired in a reasonable time or without charge, you may write the Administrator, National Highway Traffic Safety Administration, 1200 New Jersey Ave. S.E., Washington, D.C. 20590

Or call the toll-free Vehicle Safety Hotline at 1-888-327-4236 (TTY 1- 800-424-9153), or go to [www.nhtsa.gov](http://www.nhtsa.gov).

### For Canadian Customers:

Please contact Ducati customer service at 1-888-391-5446 or for additional information about the recall you, can contact Transport Canada at 1-800-333-0510.

### TREAD ACT CUSTOMER REIMBURSEMENT PLAN

If you have paid for the repair described in the attached letter, and you would like to be considered for reimbursement, please contact your authorized Ducati dealer. Expenses from repair facilities outside of the authorized Ducati dealer network will be considered; however, the procedure must meet Ducati North America's standards.



## **CR212 - Rear Brake Hose Replacement**

Monster 797 Model Year 2017-2020 (USA-CAN only)  
Safety Recall Campaign SRV-RCL-21-005

Your authorized Ducati retailer will request a copy of your owner notification letter, as well as, a copy of your previously paid invoice. They will inspect the vehicle, if still in your possession, prior to submitting a claim on your behalf to Ducati North America, Inc. for reimbursement. Only a repair involving this safety recall campaign is reimbursable. Ducati North America, Inc will not reimburse consequential expenses such as towing, rental, and accommodations.

We recommend that your authorized Ducati dealer be your primary contact on this issue. We anticipate that your authorized Ducati dealer will be able to answer any questions that you may have regarding your qualifications for reimbursement of a previous repair; additionally, our Customer Relations Dept. may be contacted at 888-391-5446 for any special assistance required.

### **What if you no longer own the vehicle?**

If you no longer own the vehicle, please e-mail your change of ownership information to [ContactUs@ducati.com](mailto:ContactUs@ducati.com) or contact Ducati North America Customer Care at 1 (888) 391-5446.

We regret any inconvenience to you from this action; however, your safety and satisfaction are important to us.

Sincerely,

Richard Kenton  
Technical Director – Ducati North America