

## SAFETY RECALL CAMPAIGN 2A96 2019 & 2020 Burgman 200 Speedometer Recall

<b>Affected Models:</b>	Certain 2019 & 2020 Burgman 200 (UH200AL9-M0) Scooter Models
<b>Affected Departments:</b>	Management, Service, Warranty, Sales, Parts, Accessories
<b>Attachments:</b>	Sales Bulletin 21-063 (Burgman 200 Stop Sales) & Customer Notification Letter

This notice is sent to you in accordance with the requirements of the National Traffic and Motor Vehicle Safety Act.

Suzuki Motor Corporation has decided that a defect which relates to motor vehicle safety exists in certain 2019 and 2020 model-year Burgman 200 scooters.

### ***STOP DELIVERY OF AFFECTED VEHICLES IMMEDIATELY***

**DO NOT SELL OR DELIVER an affected scooter to a customer until you have completed or verified completion of the repair procedures outlined in this bulletin.**

**It is a violation of Federal law to sell or deliver any new motorcycle, scooter, ATV, or item of motor vehicle equipment subject to a safety recall campaign under a sale or lease until the defect or non-compliance has been corrected.**

**In addition, selling an unrepaired affected motorcycle, scooter, or ATV is a direct violation of your Suzuki dealer agreement and may lead to additional sanctions.**

#### **What is the defect?**

Due to insufficient corrosion resistance on speed sensor power supply circuit parts inside the speedometer assembly, corrosion may cause a poor electrical connection between the speed sensor and its electric power supply. In the worst case, the speedometer and odometer may not work properly.

#### **What your dealership will do:**

- 1) Check your unsold inventory to see if you have any affected Burgman 200 models (use the identification process on the following page). If so, order the necessary parts, repair the scooter and then submit a warranty request to Suzuki Motor USA, LLC (SMO). You must do this before selling or transferring the scooter.
- 2) Check your sales records to contact customers to whom you have sold an affected Burgman 200. Contact the owner of an affected scooter to alert him/her that you are ordering the necessary recall repair parts. Let the customer know there will be no charge for parts or labor. Set an appointment to install the parts, perform the recall service, and then submit a warranty request to SMO.
- 3) If your dealership is contacted by someone who has an affected Burgman 200, but you did not sell the scooter, let the owner know you can assist with the recall service. Let the customer know there will be no charge for parts or labor. You can then order the necessary recall repair parts. Set an appointment to install the parts, perform the recall service, and then submit a warranty request to SMO.

**Verify if the scooter is affected by the safety recall:**

Confirm the recall status by checking the vehicle identification number (VIN) against the Vehicle Master in Suzuki Connect to see if the scooter is eligible for the campaign inspection and replacement procedure. If you have a question regarding scooter eligibility, call Tech-Line at (714) 996-7480 or contact your Suzuki Technical Service & Parts Manager (TSPM).

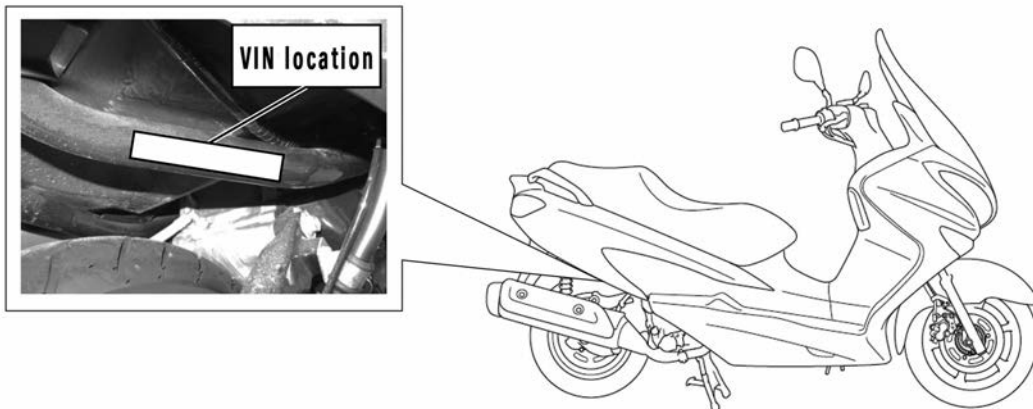

<b><u>Affected model</u></b>	<b><u>Model year</u></b>	<b><u>VIN Range</u></b>
UH200AL9	2019 (L9)	MLCCH41A#K1600001 - MLCCH41A#K1600120
UH200AM0	2020 (M0)	MLCCH41A#L1600001 - MLCCH41A#L1600150

Note: “#” indicates any check digit from 0 to 9 and X.

**What Suzuki Motor USA, LLC, will do:**

During the week of May 24, 2021, Suzuki Motor USA, LLC (SMO) will mail notifications to owners of affected Burgman 200 scooters for whom we have information. The notice instructs the customer to contact a Suzuki dealer to schedule an appointment for the repair.

If you have sold an affected Burgman 200 to a customer prior to receiving this bulletin, please contact the customer immediately to arrange for the scooter to be returned to your dealership for this safety recall campaign.

**Ordering parts for the Safety Recall Campaign:**

You will be responsible for ordering parts for this recall using normal parts ordering procedures for each scooter. If you have any questions regarding parts orders, please contact SMO Parts Coordination at (714) 854-2165.

**Parts ordering information:**

Part description: SPEEDOMETER, ASSY  
Part number: 34100-12JU2-RX0  
Quantity: 1

**Identification of recall campaign parts (new speedometer):**

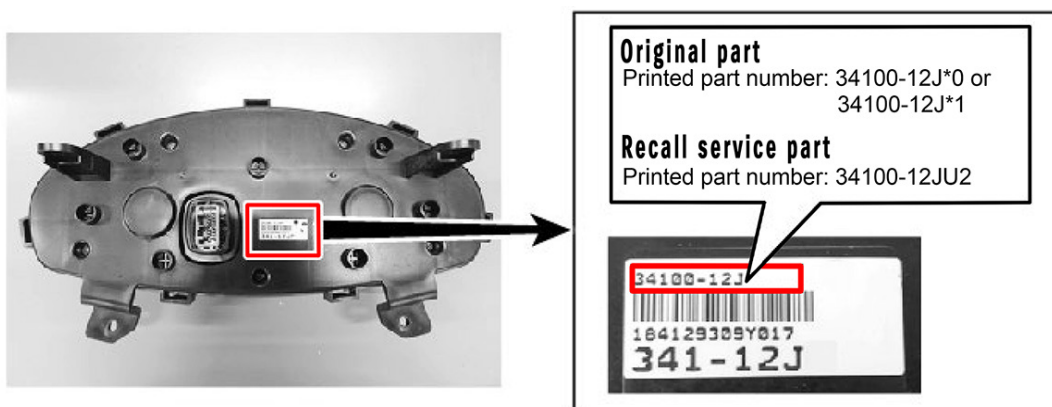

**Warranty claim processing:**

Submit a warranty claim for each recall repair immediately upon completion. This campaign requires you to file a warranty claim using ONE of the methods described below.

**Suzuki Connect Short Campaign Claim:** The Short Campaign Claim will reimburse you for the replacement of the speedometer assembly and 0.8 hour labor.

<b>CAMPAIGN 2A96 UH200A SPEEDOMETER SUZUKI CONNECT SHORT FORM INSTRUCTIONS</b>	
<b>CLAIM INFORMATION:</b>	
CLAIM NUMBER:	XXXXX,X (Dealer enters number)
ENTRY TYPE:	VIN, Model/Frame or Control/Sequence # (Dealer chooses)
REPAIR DATE:	Enter date of repair
MILEAGE:	Enter mileage at repair date
CAMPAIGN NUMBER:	2A96
LABOR OPERATION:	SE9999

**Suzuki Connect Long Campaign Claim:** The Long Campaign Claim will reimburse you for the replacement of the speedometer assembly and 0.8 hour labor, and additional parts and labor as authorized by your TSPM.

<b>CAMPAIGN 2A96 UH200A SPEEDOMETER SUZUKI CONNECT LONG FORM INSTRUCTIONS</b>	
<b>CLAIM INFORMATION:</b>	
CLAIM NUMBER:	XXXXX,X (Dealer enters number)
ENTRY TYPE:	VIN, Model/Frame or Control/Sequence # (Dealer chooses)
REPAIR DATE:	Enter date of repair
MILEAGE:	Enter mileage at repair date
CAMPAIGN NUMBER:	2A96
LABOR TIME:	As authorized by your TSPM
<b>PARTS INFORMATION:</b>	
ADDITIONAL PARTS:	Additional parts as authorized by your TSPM
AUTHORIZATION:	Only needed if additional parts or labor claimed
<b>FAILURE DESCRIPTION:</b>	
DESCRIPTION OF DEFECT:	Speedometer replacement
DESCRIPTION OF REPAIR:	Performed service campaign repair per service bulletin

**IMPORTANT - Recording the odometer reading:**

It is imperative the odometer reading (mileage) be accurately recorded on the repair order when the customer brings the scooter in for recall service. This information is required to record on the ODOMETER CHANGE LABEL that must be applied to the scooter (see page 9 of this bulletin). The original mileage is also required for proper warranty claim processing and for the customer to keep for future transactions related to the scooter.

If the scooter is traded in or sold to a new owner, the current owner must declare that the speedometer/odometer was replaced and what the mileage was when the replacement occurred. Please explain this requirement to your customers and advise them to keep the repair order copy with the original mileage in a safe place.

# SPEEDOMETER REPLACEMENT RECALL SERVICE

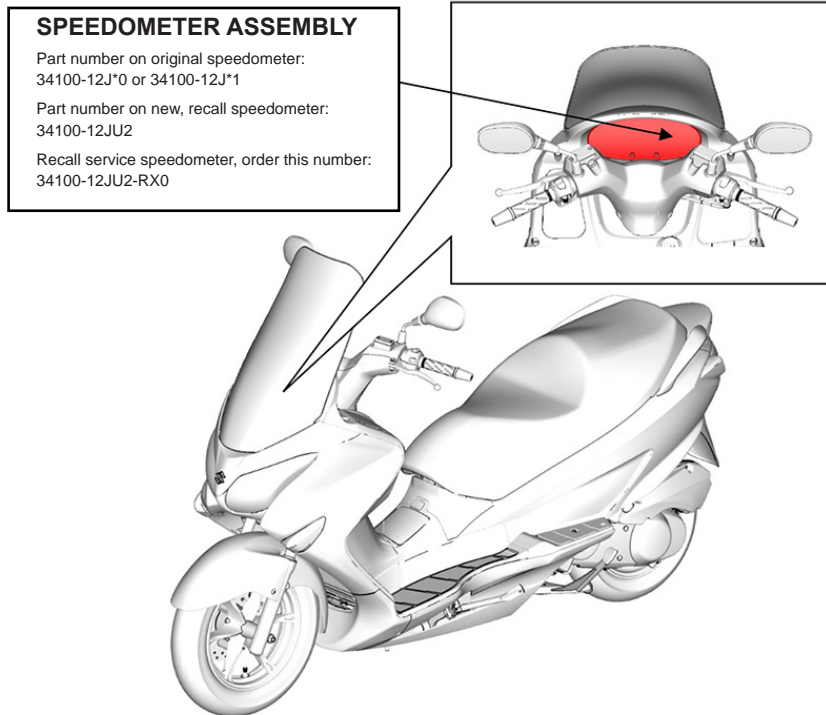

## **Precautions:**

- To avoid getting burned, do not touch the engine and exhaust system until they have cooled.
- Before the repair work, wash dirt from the scooter to prevent dirt contamination.
- When removing parts to be reused, arrange them in an orderly manner so they can be reinstalled in the proper order and orientation.
- Refer to the Burgman 200 Service Manual (99500-31523-03E) for any details or procedures not mentioned in these instructions.

## **Required tools:**

- Phillips screwdriver, #2 tip, medium to long shaft
- Phillips screw driver, #3 tip, medium to long shaft
- Phillips screw bit #2 socket (to fit to torque wrench)
- 10 mm socket wrench -or- wrench
- Torque wrench, must read 1.5 lb-ft (2.0 N.m, 0.2 kgf-m)

## **IMPORTANT - Record the odometer reading & oil service interval:**

Before starting the recall repair work, record the current mileage on the odometer and the remaining distance to the next oil change using the following procedure:

1. Turn the ignition switch to the “ON” position to display the odometer so you can record the current mileage (a).
2. Press and hold the ADJ button for 2 seconds. The odometer will then display the last reset mileage (b) while blinking three times and then display the current interval setting (c).
3. Record the remaining distance of oil change interval calculated by the formula “(b)+(c)-(a)”.
4. Turn off the ignition switch.

**Speedometer removal:**

1. Remove the right floor mat ①.
2. Remove the battery cover by removing the screws ②.

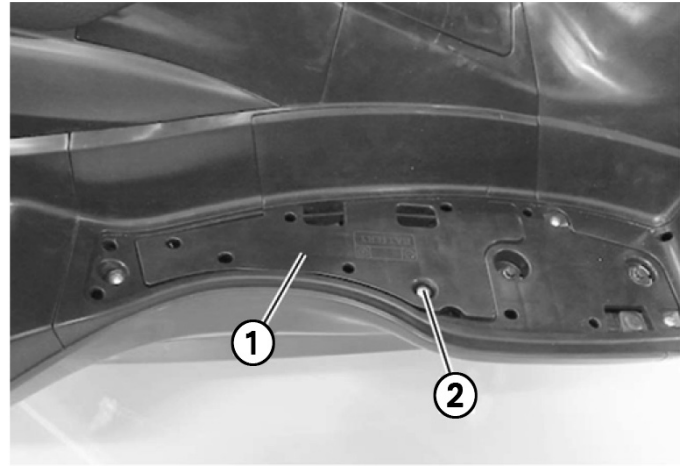

3. Disconnect the battery negative lead wire ③.

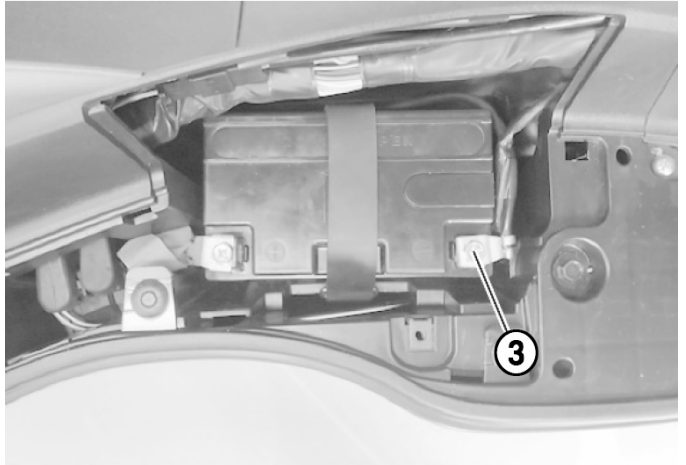

4. Remove the front cover screws ④.



5. Pull the front cover ⑤ forward, pull down to disconnect the hooks ⑥ on both sides of the front cover.

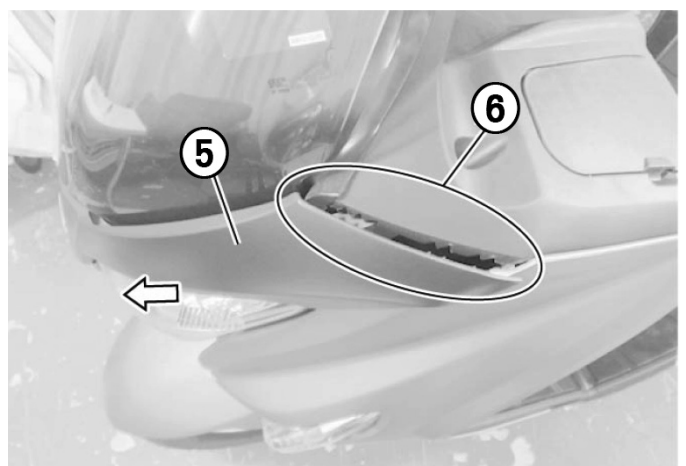

6. Pull the front cover ① forward and remove it.

**NOTE:** There are hooks ② under the front cover.

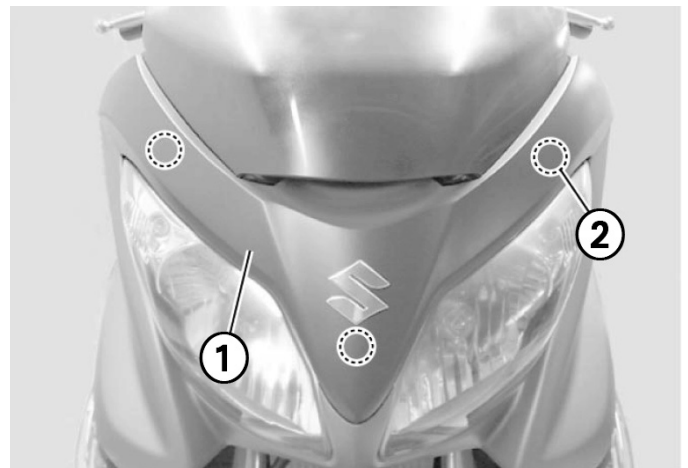

7. Remove the windscreen ③ by removing the windscreen screws ④.

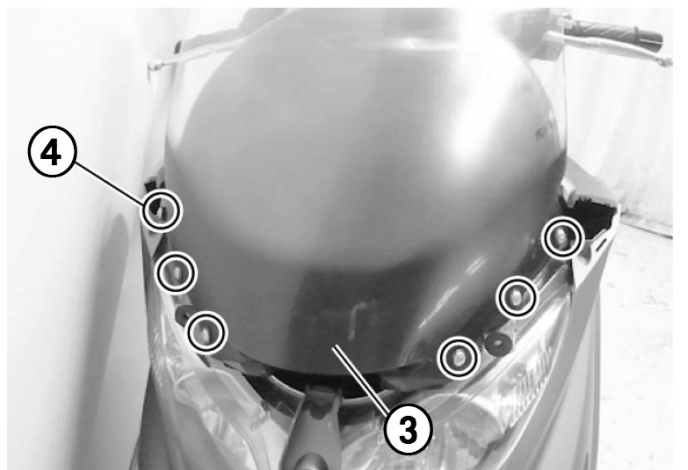

8. Remove the lower meter panel mounting screw ⑤.

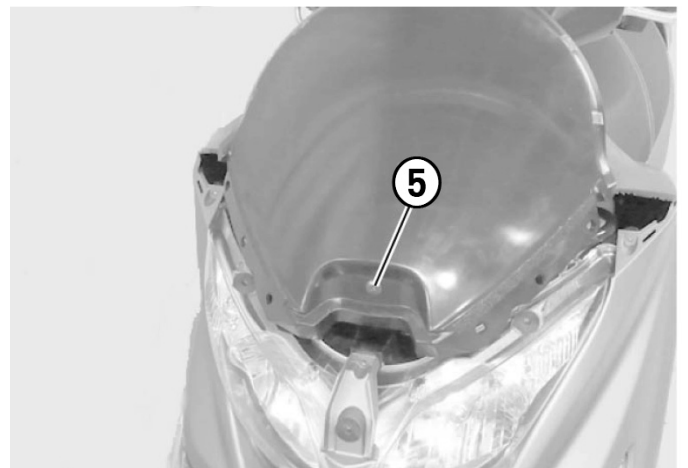



9. Remove the speedometer mounting screws ①.

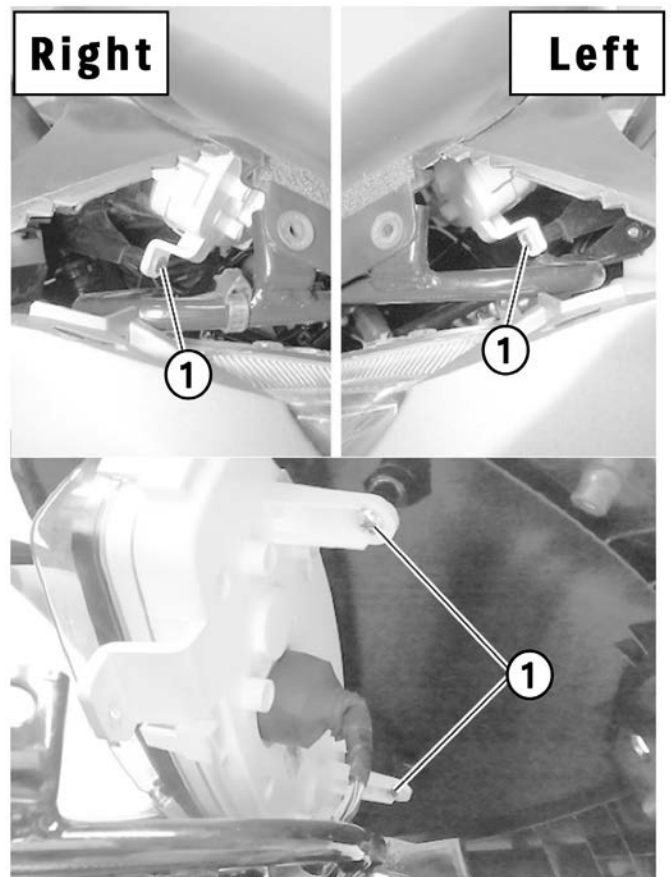

**NOTE:** Be careful to not drop the screws and other items inside the bodywork.

10. Remove the lower meter panel ②.

**NOTE:** Be careful to not damage the hooks ③ when removing the lower meter panel ②.

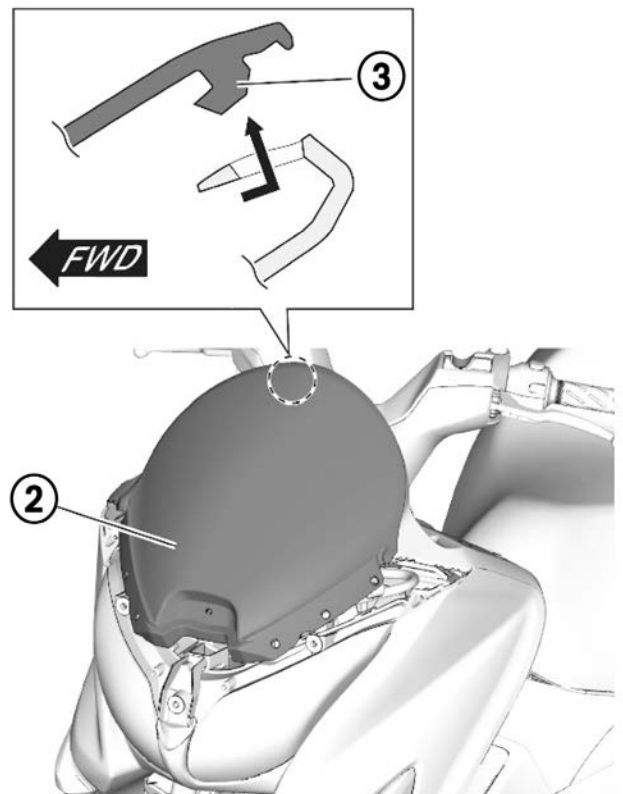

### **Speedometer replacement:**

1. Disconnect the speedometer electrical connector ①.
2. Replace the original speedometer ② with the new speedometer.
3. Connect the electrical connector ① to the new, mounted speedometer.
4. Tighten the speedometer mounting screws ③ to the specified torque and install the lower meter panel ④ and brace ⑤.

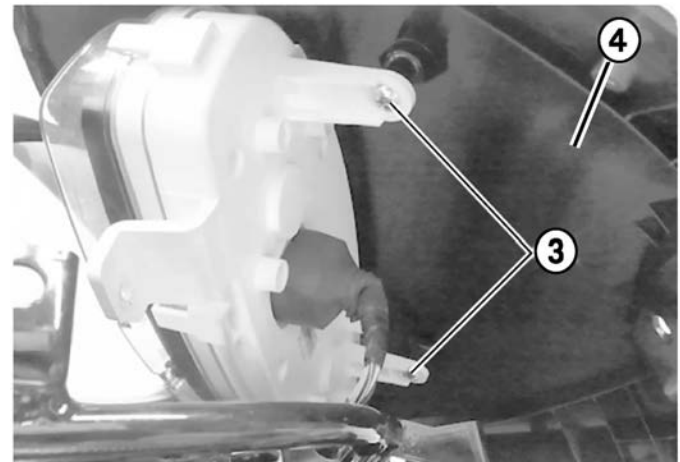
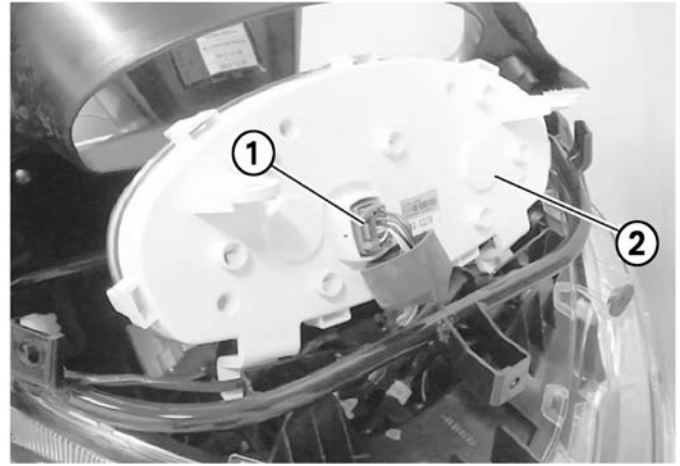

### **Tightening torque:**

**Speedometer mounting screw ③:**  
1.5 lb-ft (2.0 N.m, 0.2 kgf-m)

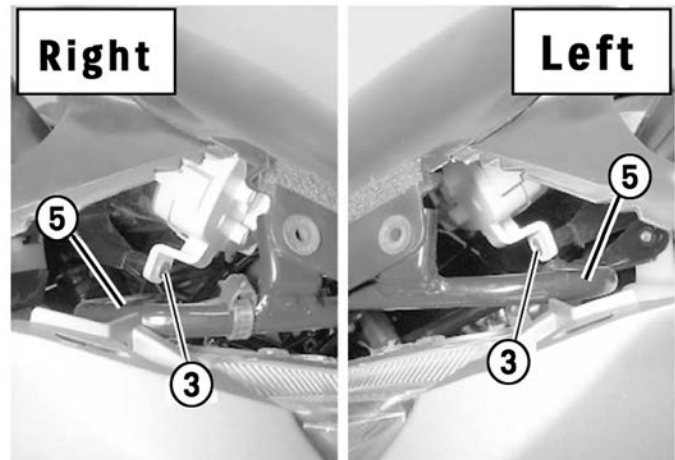



## Removed parts installation:

1. Install the removed parts in the reverse order of removal.

**NOTE:** Refer to the Service Manual if guidance is required.

## Applying odometer replacement label:

1. Included with the speedometer is an ODOMETER CHANGE LABEL ①.
2. Using a fine-tip, permanent marker (such as a black, ultra-fine point Sharpie brand marker) record the following information on the Odometer Change Label:

- Original odometer mileage
- Technician name
- Suzuki dealership name
- Suzuki dealer number
- Repair date

3. Adhere the filled-out change label ① to the right, inner side of the under seat cargo tray ②, adjacent to the existing white tire specification label.

**NOTE:** The right side of the scooter is the side opposite of the side stand.

Make sure the surface of the cargo tray is clean and dry so the change label will stick to its surface.

If required, additional ODOMETER CHANGE LABELS can be ordered from the Suzuki Parts Department using the part number 99924-00609.

①

**NOTICE**

The odometer on this vehicle was repaired or replaced and the mileage set at zero

from \_\_\_\_\_ miles

By \_\_\_\_\_

\_\_\_\_\_

Date \_\_\_\_\_

**FEDERAL LAW PROHIBITS REMOVAL OR ALTERATION OF THIS STICKER**

**ODOMETER CHANGE LABEL (99924-00609)**

**NOTICE**

The odometer on this vehicle was repaired or replaced and the mileage set at zero

from 12,025 miles

By Kurt Hayden

Surf City Suzuki

Dir. #201766

Date 06/18/2021

**FEDERAL LAW PROHIBITS REMOVAL OR ALTERATION OF THIS STICKER**

**Completed Example**



## **Final check & meter reset:**

1. Verify that each part is properly installed and the mounting hardware is tightened securely.
2. Verify that the new speedometer works properly as follows:
  - Check that the LEDs (FI indicator or MIL ①, ABS indicator light ②, ECO mode indicator ③, and ECT indicator ④) immediately illuminate when the ignition switch is turned ON.
  - Check that the other LEDs (High-beam indicator ⑤, and turn signal indicators ⑥) operate properly when the dimmer or turn signal switches are operated.

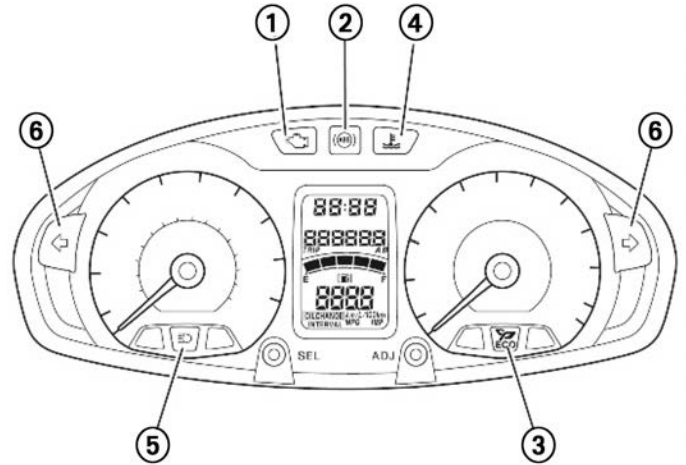

3. Set the time on the clock (refer to Owner's Manual).
4. When returning the repaired scooter, educate the customer about the following points:
  - The odometer will only show mileage from your quality control test ride.
  - Show the customer the scooter's actual mileage recorded on the repair order and how many miles until the next oil change.
  - Offer to reset the oil change interval for the customer, once the odometer reaches 600 miles.

**NOTE:** The oil change interval on the new speedometer can not be set or reset until the scooter has been ridden 600 miles (1000 km).

**SALES**



Way of Life!

Bulletin No: 21-063

Date: April 27, 2021

**IMPORTANT SAFETY RECALL**  
**STOP RETAIL SALES and DELIVERY**

Suzuki Motor Corporation has determined that a safety defect exists in certain UH200AL9/M0 models:

Model	VIN		
UH200AL9	MLCCH41A8K1600012	MLCCH41A0K1600053	
	MLCCH41A5K1600033	MLCCH41A1K1600093	
	MLCCH41A9K1600035		
UH200AM0	MLCCH41A6L1600026	MLCCH41A9L1600005	MLCCH41A2L1600105
	MLCCH41A2L1600024	MLCCH41A4L1600073	MLCCH41A9L1600098
	MLCCH41A6L1600060	MLCCH41A7L1600066	MLCCH41A0L1600135
	MLCCH41A8L1600058	MLCCH41A5L1600079	MLCCH41A0L1600121
	MLCCH41A4L1600039		

Suzuki Motor Corporation is initiating a safety recall campaign to address potential speedometer and odometer function. Due to insufficient corrosion resistance of internal parts for the speed circuit power supply, the speedometer may lose its electric power and both speedometer and odometer may not work properly.

**Technical Service Bulletin:**

Initial Service information regarding this safety recall will be provided in a Technical Service Bulletin the week of May 17, 2021.

**Parts Availability:**

Suzuki Motor USA, LLC (“SMO”) will provide additional information regarding parts availability in a Technical Service Bulletin referenced above.

**Customer Notification:**

SMO expects to notify retail customers of this safety recall by the week of May 24, 2021.

**SALES**



Way of Life!

Bulletin No: **21-063**

Date: **April 27, 2021**

**Consequences of Non-Compliance:**

**ALL NEW SUZUKI VEHICLES IN DEALER INVENTORY THAT ARE SUBJECT TO A RECALL OR CUSTOMER SATISFACTION CAMPAIGN INITIATED BY SMO MUST BE REPAIRED BEFORE THESE VEHICLES ARE SOLD OR DELIVERED BY THE DEALER TO THE RETAIL CUSTOMER. FAILURE TO DO SO IS A VIOLATION OF FEDERAL LAW, THE SUZUKI POWERSPORTS DEALER SALES AND SERVICE AGREEMENT (THE "DEALER AGREEMENT"), AND SMO'S SALES POLICY REGARDING FACTORY SAFETY RECALL OR SAFETY MODIFICATION PROGRAMS (THE "POLICY"). A COPY OF THE POLICY IS AVAILABLE ON SUZUKI CONNECT FOR YOUR REFERENCE.**

**FURTHER, FAILURE TO COMPLY WITH THE INSTRUCTIONS OF SMO REGARDING COMPLIANCE WITH RECALLS OR OTHER SAFETY OR PRODUCT IMPROVEMENT CAMPAIGNS OR PROGRAMS, AND/OR FAILURE TO MAKE A GOOD FAITH EFFORT TO COMPLY WITH THE FEDERAL CLEAN AIR ACT, THE NATIONAL TRAFFIC AND MOTOR VEHICLE SAFETY ACT, THE CONSUMER PRODUCT SAFETY ACT, OR ANY OTHER LAWS, ORDERS, RULES, OR REGULATIONS REGARDING RECALLS OR OTHER SAFETY OR PRODUCT IMPROVEMENT CAMPAIGNS OR PROGRAMS CONSTITUTES A BREACH OF THE DEALER AGREEMENT AND IS A VIOLATION OF SMO POLICY REFERENCED ABOVE. A DEALER MAY BE HELD RESPONSIBLE FOR ANY PRODUCT DAMAGE AND/OR PERSONAL INJURIES RESULTING FROM SUCH FAILURE.**

If you need any additional information, please contact the Suzuki Techline or your Technical Service and Parts Manager at 714-996-7480. We apologize for this inconvenience and will do everything possible to resolve this situation as quickly as possible.

Thank you for your continued support and understanding.

A handwritten signature in black ink that reads "Chris Coons".

Chris Coons  
Senior Manager, Motorcycle Sales Planning and Administration



## IMPORTANT SAFETY RECALL

### This Notice Applies to Your Suzuki Vehicle Identification Number (VIN)

May 24, 2021

Dear Suzuki Owner:

This notice is sent to you in accordance with the requirements of the National Traffic and Motor Vehicle Safety Act.

Suzuki Motor Corporation has decided that a defect which relates to motor vehicle safety exists in certain model-year Burgman 200 scooters. According to our records, you own one of the scooters affected by this recall campaign.

#### **What is the defect and what will your dealership do to correct it?**

Suzuki Motor Corporation is initiating a safety recall campaign of 2019 & 2020 Burgman 200 scooters.

Due to insufficient corrosion resistance on speed sensor power supply circuit parts inside the speedometer assembly, corrosion may cause a poor electrical connection between the speed sensor and its electric power supply. In the worst case, the speedometer and odometer may not work properly.

Your Suzuki dealer will verify if your scooter requires the recall service and, if necessary, order and install an improved speedometer assembly. This recall service will take approximately one hour to complete. Parts are available now, and there will be no charge to you for any recall service-related parts or labor.

#### **⚠ WARNING**

Operating your scooter without having the recall service performed increases the risk of a crash.

To minimize the risk of a crash:

- Please do not ride nor allow anyone else to ride your scooter until this recall service has been completed.
- If you must ride your scooter before this safety recall service has been completed, check the speedometer and other items for proper operation as outlined in the "INSPECTION BEFORE RIDING" checklist in section 4 of your owner's manual before each ride.

#### **What you should do:**

Make sure you are prepared for the recall service by taking the following steps:

- Contact your dealer as soon as possible to make an appointment for the recall service. Be prepared to provide them with the VIN of your scooter (provided at the top of this notice).
- Please take this notice to your dealer to help your dealer process your claim.

#### **What to do if you receive this notice in error:**

This notice was mailed to you according to the latest information that is available to us. If you no longer own the Suzuki scooter described in this notice, please complete and return the attached Change of Address/Ownership card to Suzuki Motor USA, LLC, and forward this recall information to the current owner (if known).

Federal regulations require that any vehicle lessor receiving this recall notice must forward a copy of this notice to the lessee within ten days.

3251 E. Imperial Highway, P.O. Box 1100, Brea, CA 92822-1100 • Phone (714) 996-7040



## CUSTOMER NOTIFICATION LETTER (page 2 of 2)

### **Customer reimbursement for repairs prior to this Safety Recall Notification:**

If your scooter is included in this recall and you have paid for repairs to address the defect that led to this recall, you may be eligible for full or partial reimbursement. Please note the following conditions for reimbursement:

- Only repairs made to address the defect that led to this recall are reimbursable. Additional expenses such as towing, car rental, accommodations, damage repairs, etc., will not be reimbursed. Reimbursement will not be provided for routine scheduled maintenance.
- Reimbursement may be limited to the suggested list price for parts, the Suzuki published flat-rate time allowance for the repair, and the labor rate that an authorized Suzuki Service Provider in the same area would charge for the same repair.
- Reimbursement claims may also be excluded when adequate documentation is not submitted by the claimant. This includes a proof of ownership, a repair order, and proof of payment for the repair.

To apply for reimbursement, contact the Suzuki Motor USA, LLC Customer Service Department at (714) 572-1490 during the hours of 7:30 AM to 4:30 PM Pacific Time.

### **Who to contact if you experience problems:**

Your Suzuki dealer can provide you the fastest response to your questions or concerns about this safety recall campaign. If you have any difficulty with this recall campaign, you may contact the Suzuki Motor USA, LLC, Customer Service Department for assistance at (714) 572-1490 during the hours of 7:30 AM to 4:30 PM Pacific Time. Please have your vehicle identification number (VIN) ready when calling.

If you need to locate your nearest Suzuki Motorcycle Dealer, please visit [www.suzukicycles.com](http://www.suzukicycles.com) and click on the "FIND A DEALER" tab, which is located in the upper right corner of our website.

If you believe that Suzuki Motor USA, LLC, has failed to provide the safety recall campaign service without charge or is unable to do so within a reasonable time, you may submit a complaint to the Administrator of the National Highway Traffic Safety Administration, 1200 New Jersey Ave., S.E., Washington D.C., 20590 or call the toll-free Vehicle Safety Hotline at 1-888-327-4236 (TTY: 1-888-424-9153) or go to [www.safercar.gov](http://www.safercar.gov).

We apologize for any inconvenience this recall campaign causes you. We hope you understand that your safety and satisfaction are important priorities for us.

Sincerely,

Suzuki Motor USA, LLC