



Revision (1) February 2021

Dealer Service Instructions for:

# Safety Recall W09 / NHTSA 20V-396 Driver Air Bag Emblem

---

**These instructions include two different repair directions based on inspection of the Driver Air Bag (DAB) emblem retainers.**

## Repair Available

**2008-2010 (RT) Chrysler Town and Country**

**2008-2010 (RT) Dodge Grand Caravan**

**2007-2011 (KA) Dodge Nitro**

*NOTE: This recall applies only to the above vehicles equipped with a Driver Air Bag (DAB).*

*NOTE: Some vehicles above may have been identified as not involved in this recall and therefore have been excluded from this recall.*

**IMPORTANT: Some of the involved vehicles may be in dealer used vehicle inventory. Dealers should complete the FINAL recall on these vehicles before retail delivery. Dealers should perform the FINAL recall on vehicles in for service. Involved vehicles can be determined by using the VIP inquiry process.**

**Subject**

The DAB emblem on about 925,200 of the above vehicles may have become loose or detached which may result in either the emblem or retainers, or both, not remaining attached to the DAB cover during DAB deployment. A loose or detached emblem or emblem retainer can become a potential projectile during a crash with DAB deployment, which increases the risk of occupant injury.

**Repair**

**The DAB must be disassembled and emblem retainers inspected in order to determine the proper repair direction:**

- **If the emblem retainers are securely attached:** Install tape on the inside of the air bag cover in order to retain the emblem retainers in the event of a DAB deployment.
- **If any emblem retainers are detached:** Remove the emblem and the emblem retainers from the DAB.
- **If the emblem is missing:** Remove the remaining emblem retainers from the DAB.

**If the emblem and retainers are removed per the repair instructions:** Advise the customer that they will receive a Customer Satisfaction Notification in their mailbox at a later date once new DAB covers with emblem become available.

**Parts Information**

**NOTE: Perform the DAB emblem retainer inspection before ordering any parts. The tape package is ONLY required if DAB retainers are securely attached. If DAB emblem retainers are loose or emblem is missing, no tape is required. The customer will receive a new DAB cover and emblem once those parts are made available at a later time.**

<u>Part Number</u>	<u>Description</u>
<b>CSZAW099AA</b>	<b>Tape Package</b>

Each package contains the following components:

<u>Quantity</u>	<u>Description</u>
1	Tape, DAB Chrysler
1	Tape, DAB Dodge

**Parts Return**

No parts return is required for this repair.

**Special Tools**

**The following special tools are required to perform this repair:**

- NPN                                      wiTECH MicroPod II
- NPN                                      Laptop Computer
- NPN                                      wiTECH Software
- 10187                                     Remover Tool, Driver Air Bag
- C-4755                                    Trim Stick

<b>Service Procedure</b>
--------------------------

**A. DAB Removal**

**NOTE:** If the DAB has been deployed or the DAB assembly is missing from the vehicle, do NOT proceed with the service procedure. Return the vehicle to the customer. No further action is required.

1. Advise the customer that if based on inspection it is determined that the DAB emblem must be removed, they will be notified at a later time to return to have a new DAB cover and emblem installed once parts are available.

**WARNING: HANDLING NON-DEPLOYED SUPPLEMENTAL RESTRAINTS.** At no time should any source of electricity be permitted near the inflator on the back of a non-deployed air bag. When carrying a non-deployed air bag, the trim cover or air bag cushion side of the unit should be pointed away from the body to minimize injury in the event of an accidental deployment. If the air bag unit is placed on a bench or any other surface, the trim cover or air bag cushion side of the unit should be face up to minimize movement in the event of an accidental deployment.

All non-deployed air bags which are replaced on vehicles are to be handled and disposed of properly. Refer to the Hazardous Substance Control System for information regarding the potentially hazardous properties of the subject component and the proper safe handling procedures. Then dispose of all non-deployed air bags in a manner consistent with state, provincial, local and federal regulations.

**WARNING: SUPPLEMENTAL RESTRAINT STORAGE.** Air bags must be stored in their original, special containers until they are used for service. Also, they must be stored in a clean, dry environment; away from sources of extreme heat, sparks, and high electrical energy. Always place or store any air bag on a surface with its trim cover or air bag cushion side facing up, to minimize movement in case of an accidental deployment.

**Service Procedure [Continued]**

2. Place the ignition in the **OFF** position.
3. Open the hood.

**WARNING: Remove metallic jewelry to avoid injury by accidental arcing of battery current.**

**WARNING: The battery negative and positive cable polarity are different from the gasoline engine equipped vehicles to the diesel engine equipped vehicles. Please note the location of the positive and negative cables prior to service of the battery or related components.**

4. Disconnect and isolate the battery negative cable.

**WARNING: To avoid serious or fatal injury, disable the Supplemental Restraint System (SRS) before attempting air bag replacement. Disconnect and isolate the battery negative (ground) cable, then wait two minutes for the system capacitor to discharge before performing further diagnosis or service. This is the only sure way to disable the SRS. Failure to take the proper precautions could result in accidental air bag deployment.**

5. Wait two minutes for the system capacitor to discharge before continuing.
6. Release the steering column tilt lever and lower the column to its most downward position for easiest driver air bag removal access.

**Service Procedure [Continued]**

7. There are three DAB retainer access holes (1) on the instrument panel side of the hub of the steering wheel (2), located at the two o'clock, six o'clock and ten o'clock positions. The steering wheel must be rotated to bring each of these access holes up to the twelve o'clock position of the steering column one at a time for removal access (Figure 1).

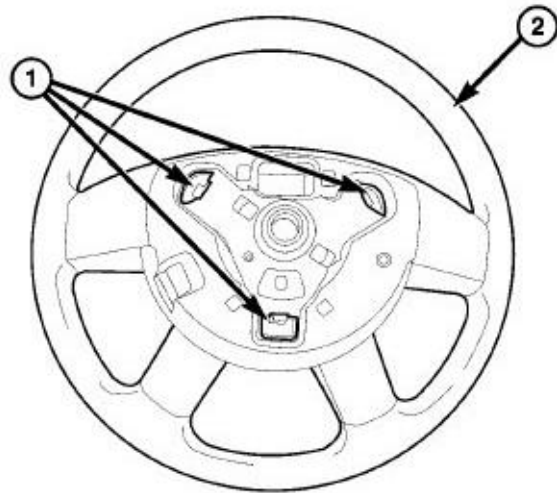

**Figure 1 – DAB Retainer Locations**

**NOTE:** It may be helpful to use a small mirror to aid visibility during the initial attempt to remove the DAB from the steering wheel.



**Figure 2 – DAB Removal Tool**

8. Insert the short blade of the DAB Removal Tool (Special Tool # 10187) or the blade of an equivalent prying tool into either of the upper (two o'clock or ten o'clock) access holes of the steering wheel hub rear trim cover, being certain to place the blade of the tool on the inboard (steering wheel hub) side of the DAB retainer wire loop (Figures 2 and 3).

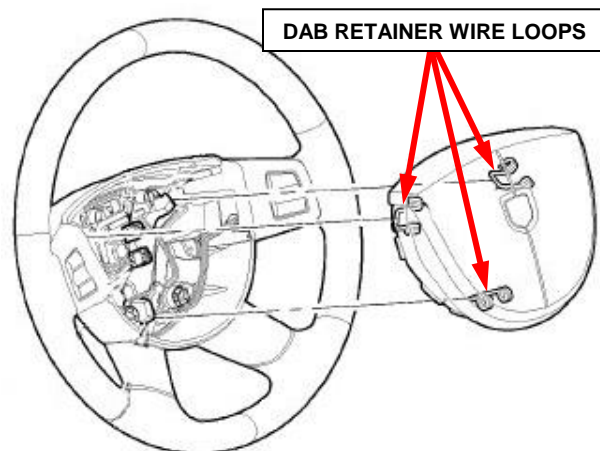

**Figure 3 – DAB Retainers**

**Service Procedure [Continued]**

9. Push the handle of the tool downward for the blade to pry the snap retainer wire loop upward far enough to disengage the loop from the hook of the steering wheel armature. At the same time, gently pull the driver air bag away from the steering wheel to prevent the retainer from snapping back into place over the hook once it is disengaged (Figures 2 and 3).
  
10. Repeat **Steps 8 and 9** at the other upper (two o'clock or ten o'clock) access hole to disengage the other upper snap retainer wire loop.
  
11. Repeat **Steps 8 and 9** at the lower (six o'clock) access hole to disengage the lower snap retainer wire loop. The lower snap retainer wire loop has a distinctive V-shape and must always be installed onto the six o'clock hook of the steering wheel armature.

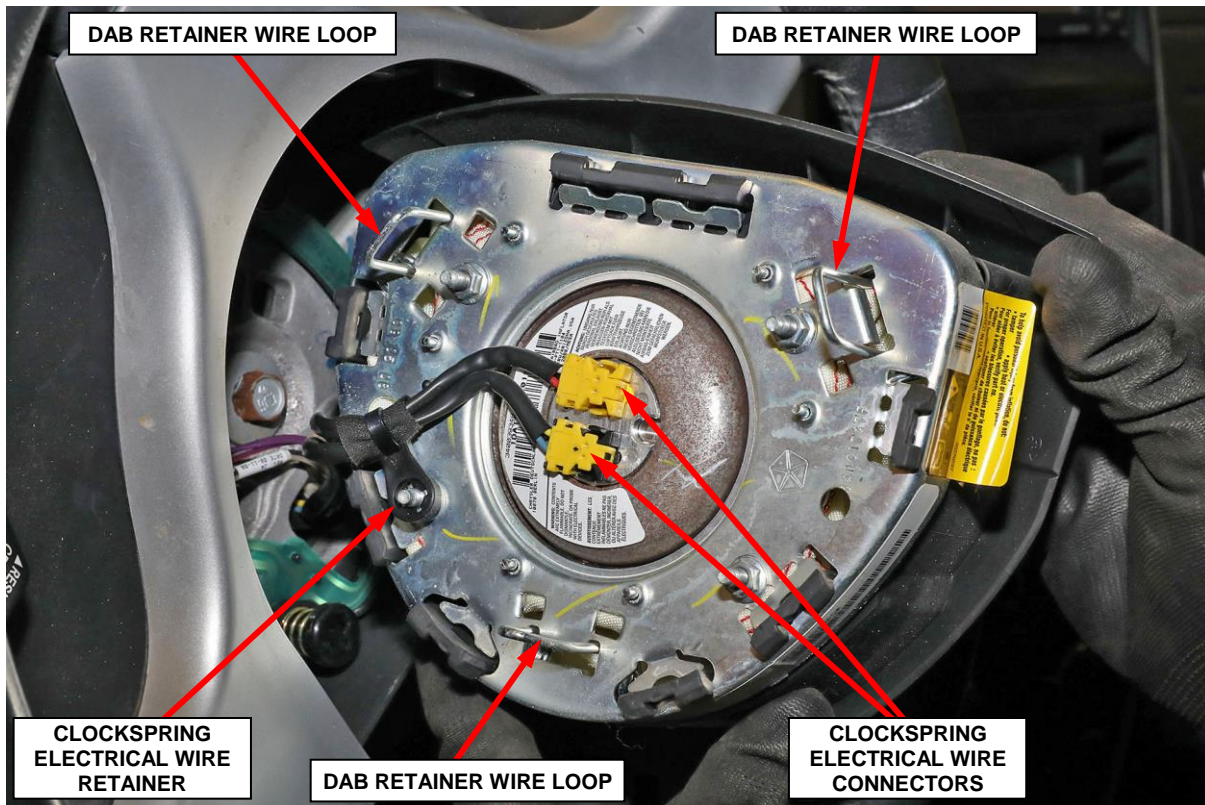

**Figure 4 – DAB Retainers and Clockspring Electrical Wire Connectors**

**Service Procedure [Continued]**

12. Pull the driver air bag away from the steering wheel far enough to access the clockspring electrical wire connectors at the back of the air bag housing (Figure 4).
13. The air bag electrical wire harness has a plastic retainer that is pushed onto one of the inflator mounting studs on the back of the air bag housing. Pull the retainer off of the stud (Figure 4).

**CAUTION: Do not pull on the clockspring pigtail wires or pry on the connector insulators to disengage them from the Driver Air Bag (DAB) inflator initiator connector receptacles. Improper removal of these pigtail wires and their connector insulators can result in damage to the air bag circuits or the connector insulators.**

14. The clockspring driver air bag pigtail wire connectors are secured by an integral lock to the air bag inflator connector receptacles, which are located on the back of the DAB housing. Firmly grasp and pull the lock straight out from the connector insulator, then pull the insulators straight out from the air bag inflator to disconnect them from the connector receptacles (Figure 4).
15. Remove the driver air bag from the steering wheel.
16. Continue with Section **B. DAB Disassembly and Inspection.**



**Service Procedure [Continued]****B. DAB Disassembly and Inspection**

**CAUTION:** Place the DAB on a clean debris free work surface for the duration of this procedure to prevent any damage to the DAB cover or the DAB internal components.

**WARNING:** To avoid serious or fatal injury, use extreme care to prevent any foreign material from entering the DAB, or becoming entrapped between the DAB cushion and the DAB trim cover. Failure to observe this warning could result in occupant injuries upon air bag deployment.

**WARNING:** To avoid serious or fatal injury, the driver air bag trim cover must never be painted. Replacement air bags are serviced with trim covers in the original colors. Paint may change the way in which the material of the trim cover responds to an air bag deployment. Failure to observe this warning could result in occupant injuries upon air bag deployment.

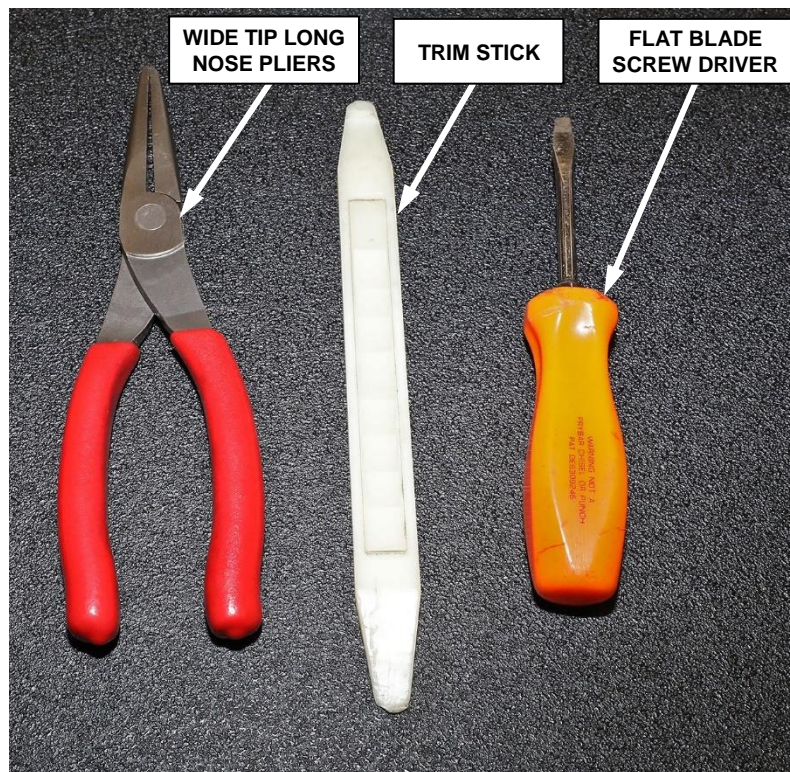

**Figure 5 – Suggested Tools for DAB Emblem and Retainer Removal**

**Service Procedure [Continued]**

1. Remove the four nuts on the back side of the DAB module (Figure 6).
2. Start with a flat blade screwdriver to begin lifting up the eight backing plate tabs then using wide-tipped long-nose pliers, finish bending tabs 90 degrees to an upright position, no further (Figure 7).

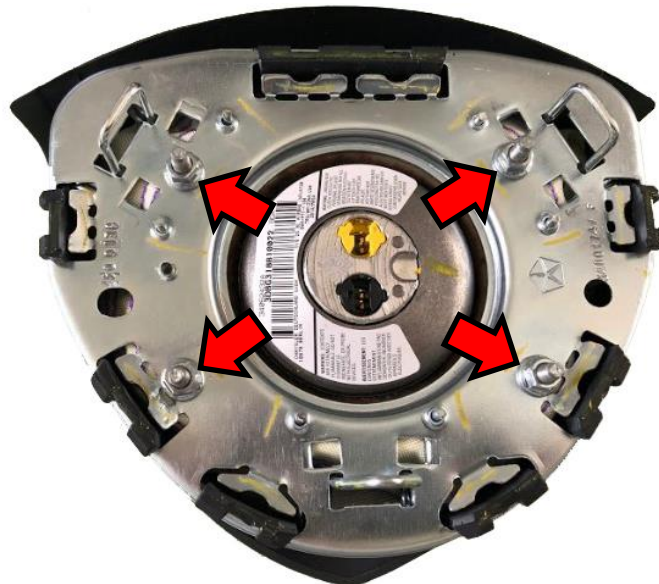

**Figure 6 – Backing Plate Four Nut Locations**

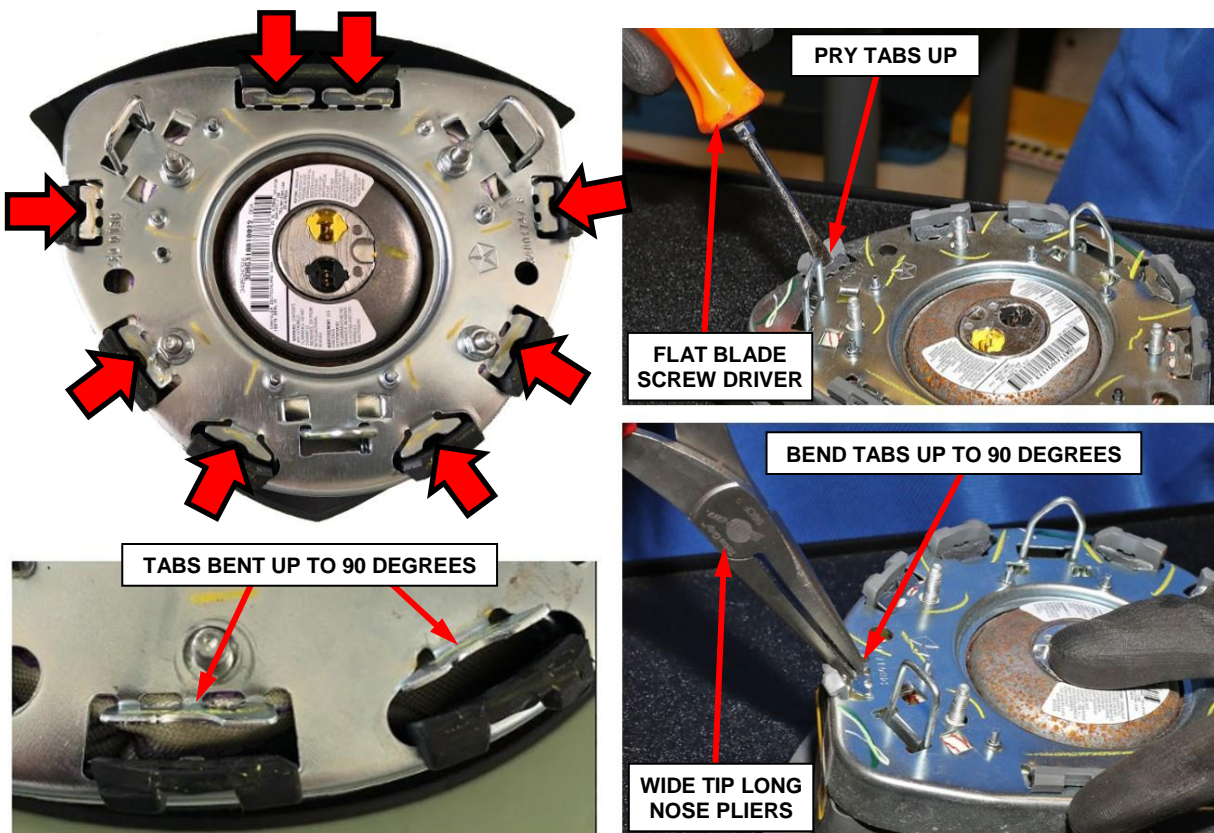

**Figure 7 – Bend Metal Backing Plate Tabs to 90 Degrees Upright Position**

**Service Procedure [Continued]**

3. Release the “Do Not Tamper” sticker from the cover to allow separation of cover from backing plate (Figure 8).



4. Using a trim stick and beginning at the “Do Not Tamper” sticker, work in a clockwise direction around the cover pushing the cover tabs inward and separate the backing plate from the cover (Figure 9).

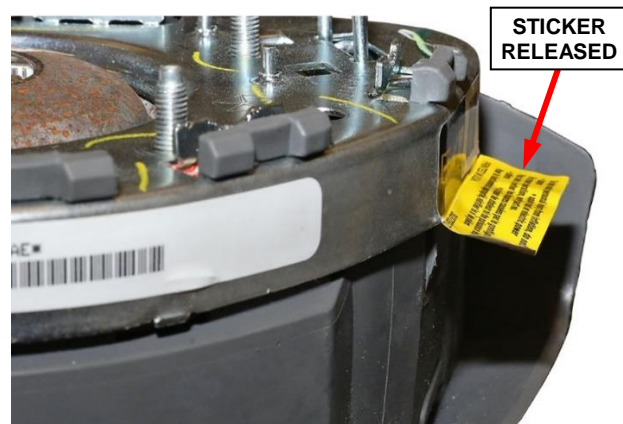

**Figure 8 – “Do Not Tamper” Sticker**

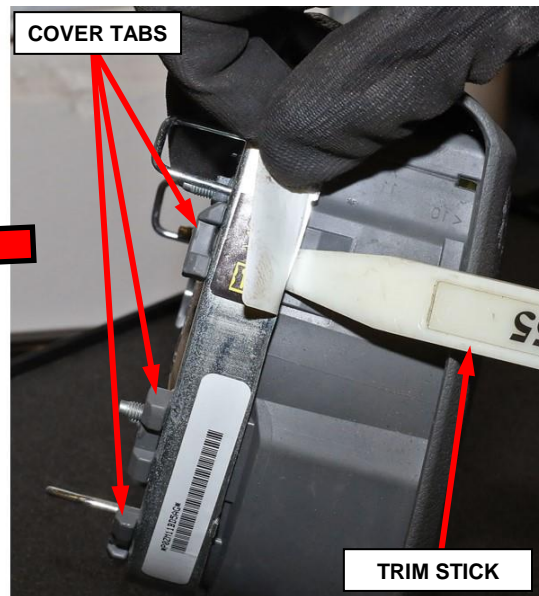
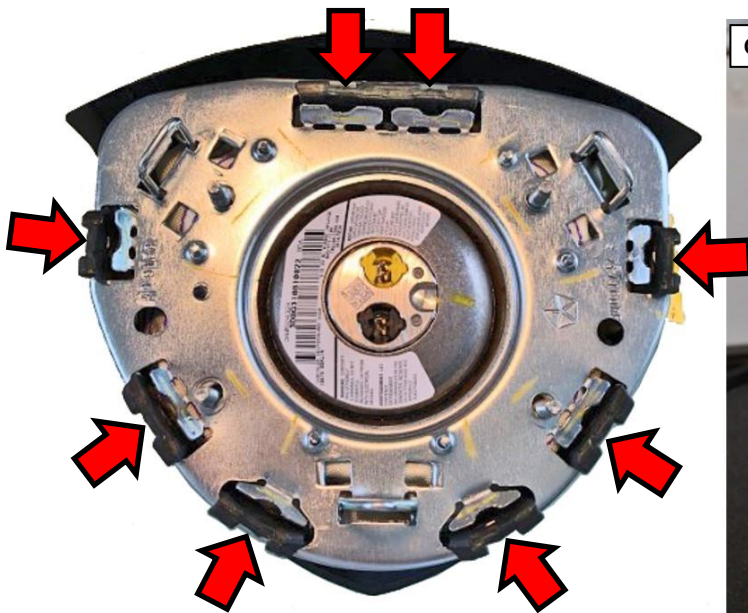

**Figure 9 – Release DAB Cover Tabs from Backing Plate**

**Service Procedure [Continued]**

5. Remove the backing plate from the cover (Figure 10).

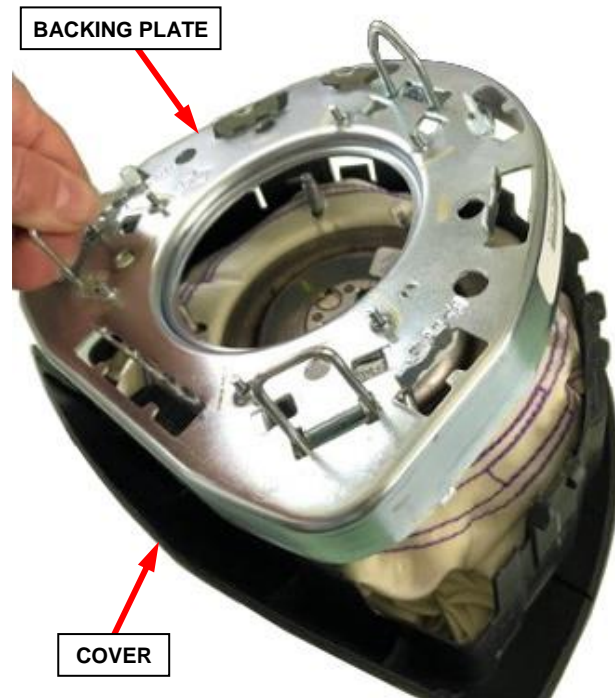

**Figure 10 – Remove Backing Plate**

6. (KA) Dodge Nitro only may be equipped with a plastic damper ring. Remove the damper ring (Figure 11).

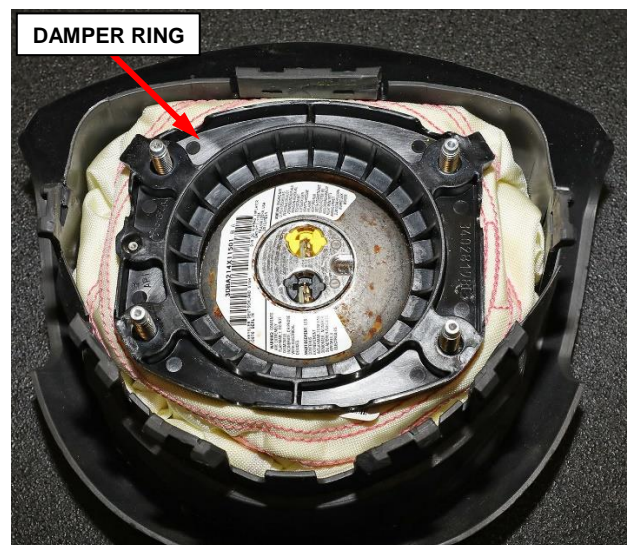

**Figure 11 – Damper Ring (KA) Only**

**Service Procedure [Continued]**

- 7. Mark the inflator orientation to the air bag cushion in case it becomes separated from the air bag cushion (Figure 12).

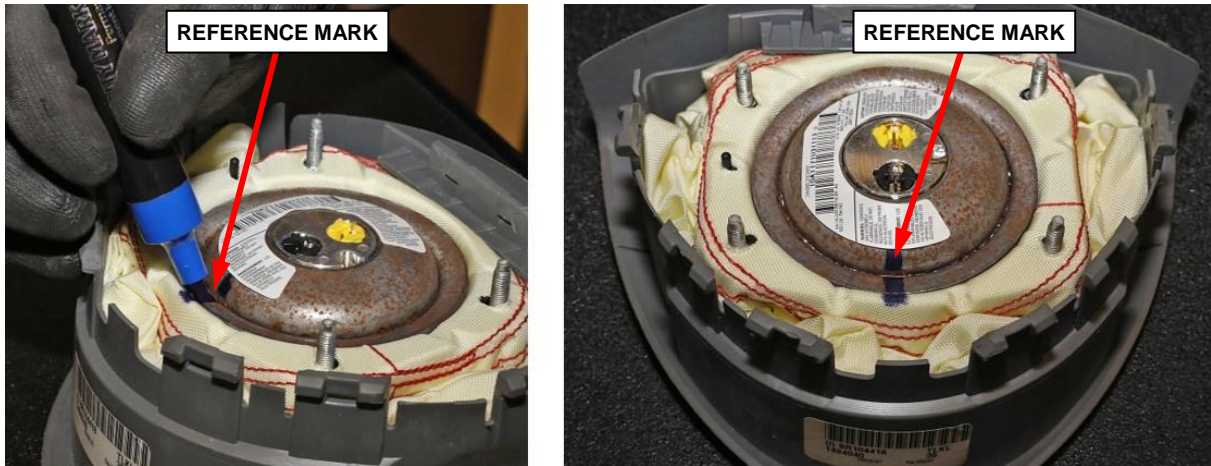

**Figure 12 – Mark Inflator Orientation**

**IMPORTANT:** Hold the inflator as it could be loose during this process. Reference cushion and inflator position prior to separating from the cover. It is not necessary to separate the inflator from the cushion (Figure 13).

- 8. The cover can be removed from the cushion by inverting the assembly and pulling back the top of the cover. The cushion and inflator should fall free from the cover (Figure 13).

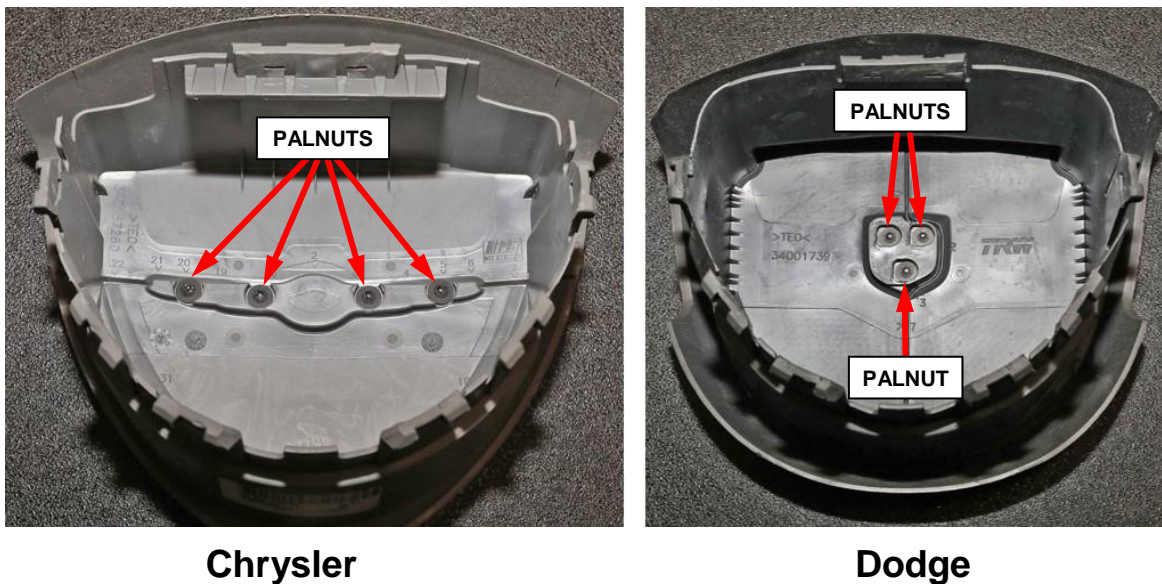

**Figure 13 – Remove Cover from Cushion**

**Service Procedure [Continued]**

9. Verify that all palnut retainers and emblem pieces are accounted for (Figure 14).
  - Chrysler emblems have four palnut retainers.
  - Dodge emblems have three palnut retainers.

If necessary, carefully inspect the air bag cushion folds for any trapped palnut retainers or emblem post pieces. Be careful to not unfold the air bag too far because it needs to be folded back exactly as it was prior to inspecting.

**Chrysler****Dodge****Figure 14 – Emblem Palnut Retainers**

10. After all palnut retainers and emblem pieces are accounted for. Place the air bag and inflator assembly in a clean safe place **away** from the DAB cover work area to prevent any air bag contamination from debris.
11. Are all palnut retainers securely attached to emblem or are any palnut retainers loose not securely attached to the emblem?
  - If **ALL** palnut retainers are securely attached to the emblem. Proceed to **Section C. Tape Installation, page 15.**
  - If one or more palnut retainers are loose or detached from the emblem. Proceed to **Section D. Emblem Removal, page 16.**

**Service Procedure [Continued]**

**C. Tape Installation**

**NOTE: This repair is ONLY for DAB emblems which are securely attached with ALL palnut retainers.**

1. Use a clean lint free towel to wipe the inside surface of the DAB cover where the tape will be applied in order to remove any lint or debris (Figure 15).



**Chrysler**



**Dodge**

**Figure 15 – Wipe Clean Tape Application Surface Inside DAB Cover**

2. Select the proper shape tape for Chrysler or Dodge. Remove the paper backing from the tape. Carefully center the tape over the emblem palnuts. Firmly press the tape to ensure good adhesion to the inside of the DAB cover (Figure 16).

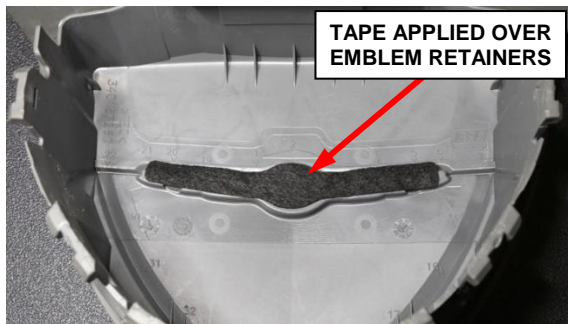

**Chrysler**

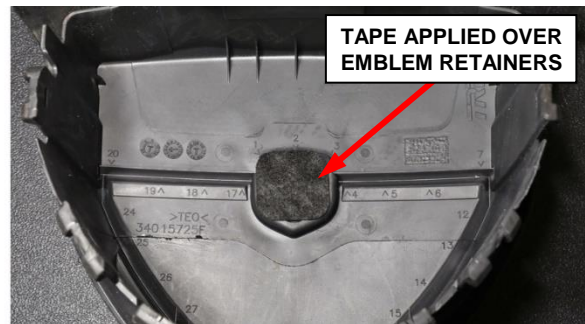

**Dodge**

**Figure 16 – Center the Tape Over the Palnuts Then Firmly Press to Adhere**

3. Proceed to **Section E. DAB Reassembly.**

**Service Procedure [Continued]****D. Emblem Removal**

**NOTE: This repair is for DAB emblems which are partly or fully detached due to one or more loose or missing palnut retainers.**

1. Using wide-tip long-nose pliers, break off any emblem posts protruding beyond the palnut retainers (Figure 17).
2. Using a flat blade screwdriver, pry the palnut retainers off of the emblem posts (Figure 17).

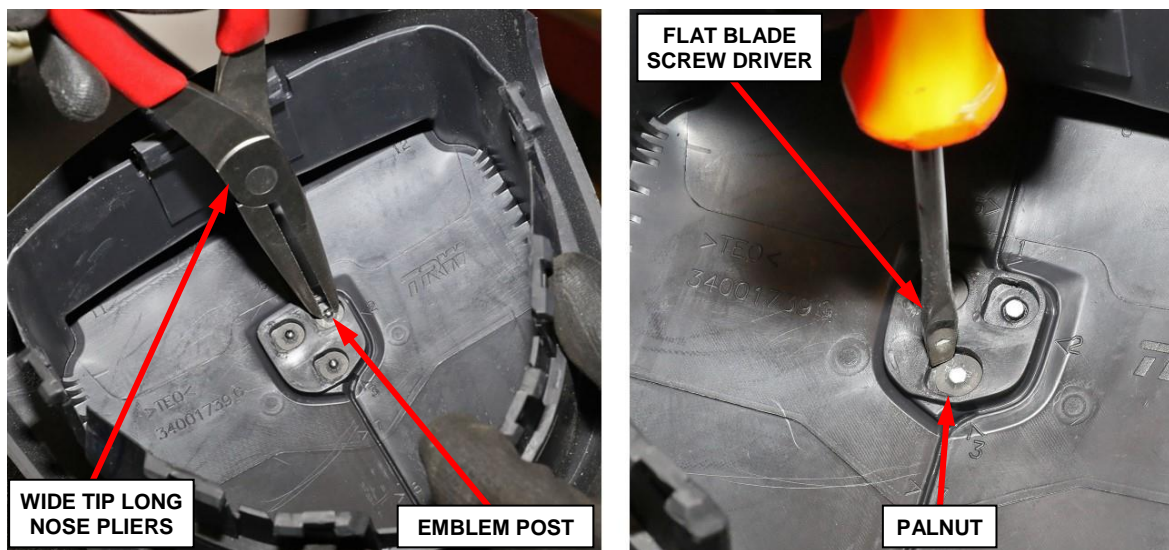

**Break Emblem Stud**

**Pry Palnut Off Stud**

**Figure 17 – Emblem Palnut Retainer Removal**

3. Remove the emblem from the cover.
4. Verify that all palnuts retainers and emblem pieces are accounted for and disposed of so as to not contaminate the air bag cushion during reassembly.
5. Proceed to **Section E. DAB Reassembly.**



**Service Procedure [Continued]****E. DAB Reassembly**

**WARNING:** Ensure there is no debris in the DAB cover or in the air bag cushion folds before reassembly.

1. Install the air bag cushion into the cover starting by tucking the cushion into the top of the cover. Once the top is tucked, apply pressure to the rest of the cushion and inflator to fit snugly into the cover. Ensure inflator studs are in a central location identical to production position. Ensure the inflator is lined up with the reference mark made earlier (Figure 18).

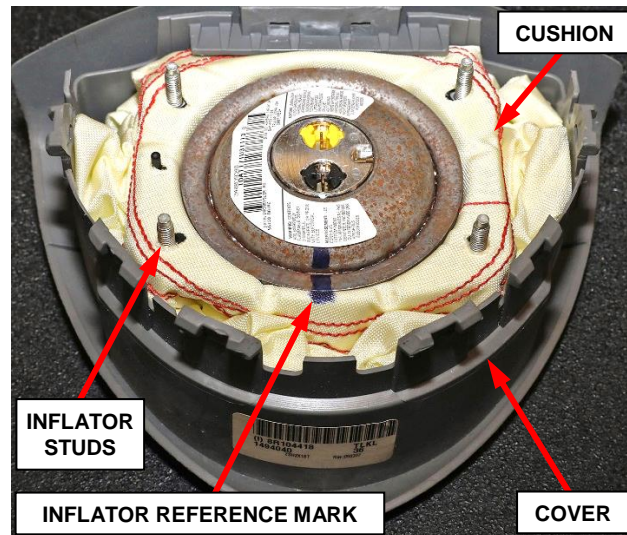

**Figure 18 – Install Cushion into Cover**

2. (KA) Dodge Nitro, if equipped, Install the plastic damper ring. Ensure the ring is properly aligned with the alignment stud (Figure 19).

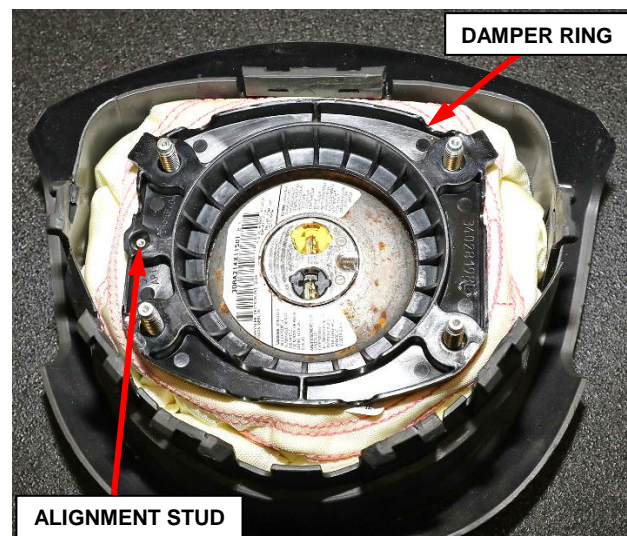
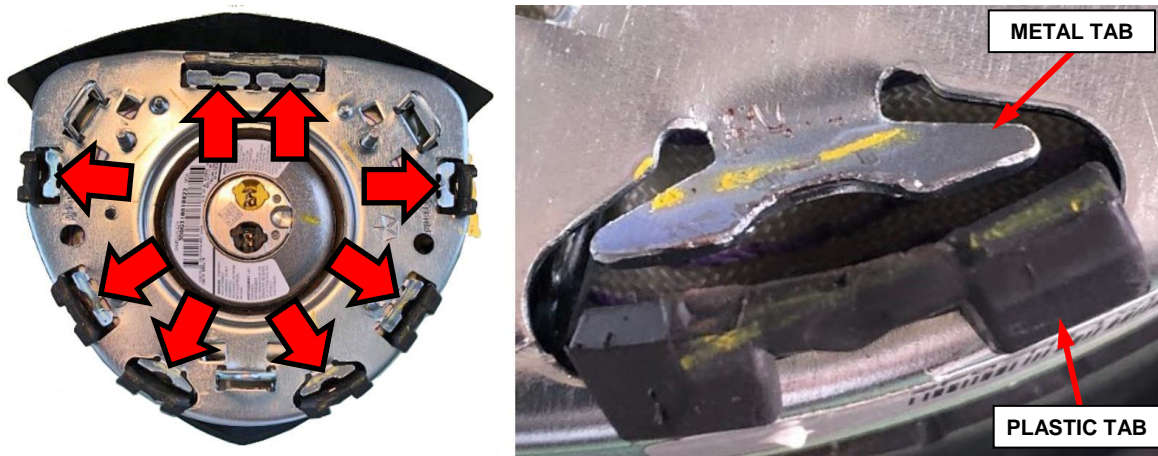

**Figure 19 – Damper Ring (KA) Only**

**Service Procedure [Continued]**

3. Install backing plate working from bottom to top, inserting the plastic cover tabs into their respective slots in the backing plate. Make sure the cover tabs are engaged with the metal backing plate divots (Figure 20).

**NOTE:** Ensure the “Do Not Tamper” sticker does not get folded under and trapped by the cover during backing plate installation.

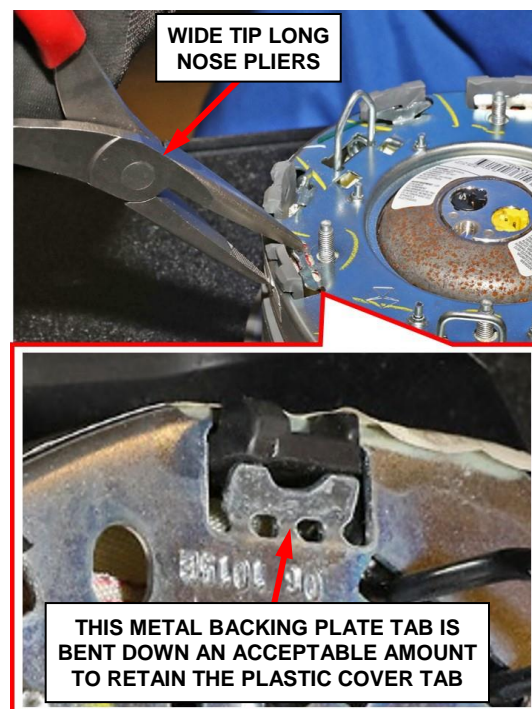

**Figure 20 – DAB Cover Installation**

4. Bend the eight metal backing plate tabs down using the wide-tipped long-nose pliers (Figures 20 and 21).

**CAUTION:** Do not use the flat blade screw driver to bend the tabs down because there is a possibility of the screwdriver tip breaking off and falling inside the DAB module.

**NOTE:** It is not required to bend the metal tabs down completely flat and parallel to the backing plate surface. Metal tabs only need to be bent far enough to retain the plastic cover tab to the backing plate (Figure 21).



**Figure 21 – Bending Backing Plate Tabs**

**Service Procedure [Continued]**

5. Reapply the “Do Not Tamper” sticker that overlaps both the plastic cover and the backing plate (**Figure 22**).
6. Install the four nuts securing the backing plate and tighten in a star pattern sequence to 5 N·m (44 in. lbs.) (**Figure 22**).
7. Continue with **Section F. DAB Installation**.

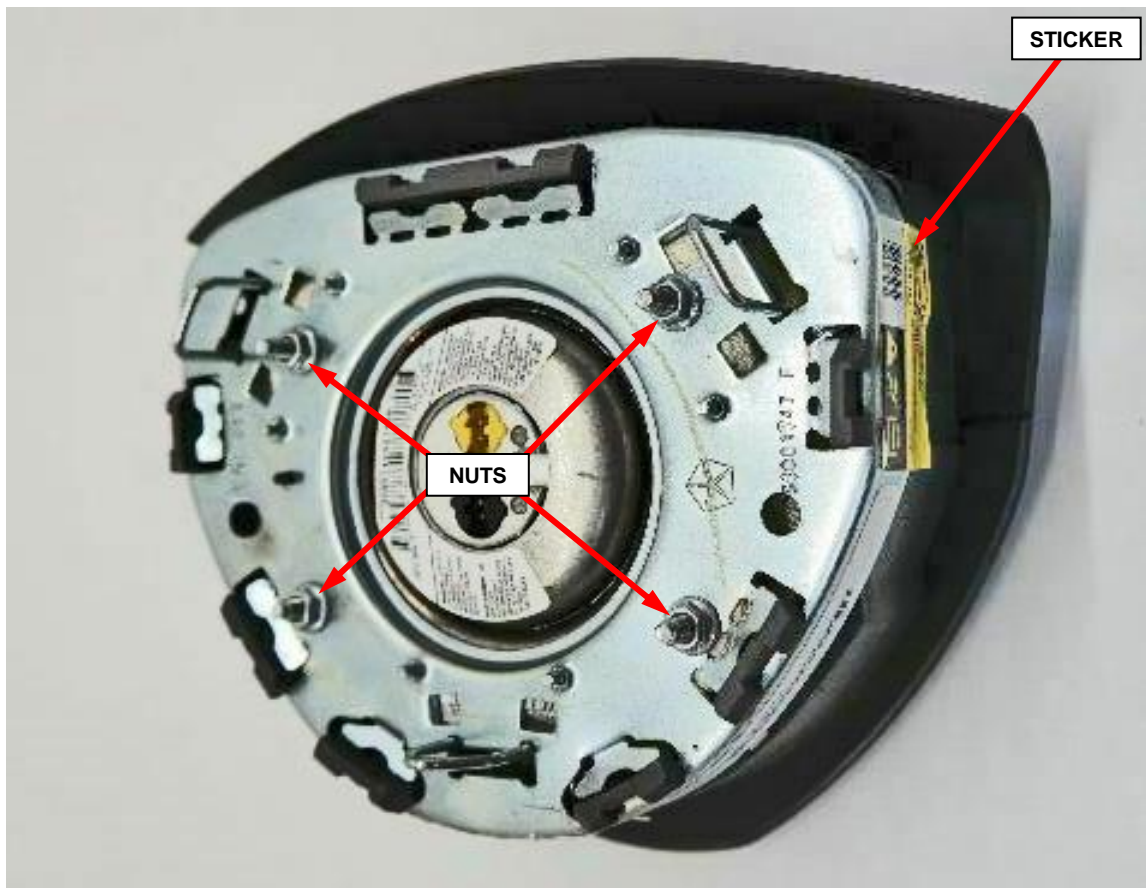

**Figure 22** – Backing Plate Nuts and “Do Not Tamper” Sticker

**Service Procedure [Continued]****F. DAB Installation**

1. Position the driver air bag close enough to the steering wheel to reconnect the electrical connections to the back of the air bag housing (Figure 4).
2. When installing the driver air bag, reconnect the two clockspring pigtail wire connector connections to the air bag inflator connector receptacles by pressing straight in on the connectors, then push the locks straight into the connectors. Be certain to engage each keyed and color-coded connector to the matching connector receptacle (Figure 4).
3. The air bag electrical wire harness has a plastic retainer that is pushed onto one of the inflator mounting studs on the back of the air bag housing. Install the retainer onto the stud (Figure 4).
4. Carefully position the driver air bag into the steering wheel hub. Be certain that the clockspring pigtail wires are not pinched between the driver air bag and the horn switch or the steering wheel armature.
5. Engage the lower air bag snap retainer wire loop onto the lower hook of the steering wheel armature. The lower snap retainer wire loop has a distinctive V-shape and must always be installed onto the six o'clock hook of the steering wheel armature (Figure 3).

**NOTE: The wiTECH scan tool must be used to perform this recall. The wiTECH software is required to be at the latest release level before performing the Supplemental Restraint System (SRS) test.**

**NOTE: During the following SRS test, the battery negative cable remains disconnected and isolated during Steps 6 and 7 as it was during the component removal and installation procedures.**

**Service Procedure [Continued]**

6. Connect the wiTECH micro pod II to the 16-way Data Link Connector (DLC). The DLC is located on the driver side lower edge of the instrument panel near the inside hood release, outboard of the steering column.
7. Turn the ignition switch to the “**RUN**” position then exit the vehicle with the scan tool and close the doors.
8. Check to be certain that nobody is in the vehicle, then connect the battery negative cable to the battery post and tighten the clamp nut to 5 N·m (44 in. lbs.).
9. Open the wiTECH 2.0 website.
10. Enter your “**User id**” and “**Password**” and your “**Dealer Code**”, then select “**Sign In**” at the bottom of the screen. Click “**Accept**”.
11. Starting at the “**Vehicle Selection**” screen, select the appropriate vehicle and Device Name.
12. From the “**Action Items**” screen, click “**All DTCs**”, select “**Clear All DTCs**”, click “**Continue**” and then click “**Close**”.
13. If DTCs are still stored, cycle the ignition OFF/ON to change DTC status from “**active**” to “**stored**” then clear DTCs again.

**Service Procedure [Continued]**

14. Turn the ignition switch to the “**OFF**” position for about 15 seconds, and then back to the “**RUN**” position. Observe the air bag indicator in the instrument cluster.
  - The air bag indicator in the instrument cluster should illuminate for six to eight seconds, and then go out. This indicates that the SRS is functioning normally and that the repairs are complete. Turn the ignition to the “**OFF**” position, remove the wiTECH micro pod II and return the vehicle to the customer.
  - If the air bag indicator fails to light or the light remains ON, there is still an active SRS fault or malfunction. Refer to the appropriate diagnostic information to diagnose the problem.
15. Close the hood, remove the wiTECH micro pod II.

**NOTE: The Electronic Stability Program (ESP) procedure must be performed anytime the battery has been disconnected. If the vehicle is equipped with ESP, once the battery is reconnected, the Steering Angle Sensor (SAS) in the clockspring needs to be calibrated. The SAS requires calibration anytime the battery or an Anti-lock Brake System (ABS) / Brake Assist System (BAS) or ESP component has been disconnected for any length of time. If the SAS is not calibrated following battery reconnection, the ESP/BAS indicator lamp is illuminated following five ignition cycles indicating the need for calibration.**

16. To calibrate the SAS, perform the following:
  - a. Start the engine.
  - b. Center the steering wheel.
  - c. Turn the steering wheel all the way to the left until the internal stop in the steering gear is met, then turn the wheel all the way to the right until the opposite internal stop in the steering gear is met.
  - d. Center the steering wheel.
  - c. Stop the engine.
17. Return the vehicle to the customer.

**Completion Reporting and Reimbursement**

Claims for vehicles that have been serviced must be submitted on the DealerCONNECT Claim Entry Screen located on the Service tab. Claims paid will be used by FCA to record recall service completions and provide dealer payments.

Use one of the following labor operation numbers and time allowances:

	<b>Labor Operation Number</b>	<b>Time Allowance</b>
Apply Tape Over DAB Emblem Retainers	19-W0-91-82	0.6 hours
Remove DAB Emblem (New DAB cover will be installed at a later date)	19-W0-91-83	0.6 hours

**NOTE: See the Warranty Administration Manual, Recall Claim Processing Section, for complete recall claim processing instructions.**

**Dealer Notification**

To view this notification on DealerCONNECT, select “Global Recall System” on the Service tab, then click on the description of this notification.

**Owner Notification and Service Scheduling**

All involved vehicle owners known to FCA are being notified of the service requirement by first class mail. They are requested to schedule appointments for this service with their dealers. A generic copy of the owner letter is attached.

**Vehicle Lists, Global Recall System, VIP and Dealer Follow Up**

All involved vehicles have been entered into the DealerCONNECT Global Recall System (GRS) and Vehicle Information Plus (VIP) for dealer inquiry as needed.

GRS provides involved dealers with an updated VIN list of their incomplete vehicles. The owner's name, address and phone number are listed if known. Completed vehicles are removed from GRS within several days of repair claim submission.

To use this system, click on the “**Service**” tab and then click on “**Global Recall System.**” Your dealer's VIN list for each recall displayed can be sorted by: those vehicles that were unsold at recall launch, those with a phone number, city, zip code, or VIN sequence.

**Dealers must perform this repair on all unsold vehicles before retail delivery.** Dealers should also use the VIN list to follow up with all owners to schedule appointments for this repair.

*Recall VIN lists may contain confidential, restricted owner name and address information that was obtained from the Department of Motor Vehicles of various states. Use of this information is permitted for this recall only and is strictly prohibited from all other use.*

**Additional Information**

If you have any questions or need assistance in completing this action, please contact your Service and Parts District Manager.

Customer Services / Field Operations  
FCA US LLC



This notice applies to your vehicle,

[Model Year and Model]

VIN XXXXXXXXXXXXXXXXXXXX

W09/NHTSA 20V-396

LOGO

VEHICLE PICTURE

#### YOUR SCHEDULING OPTIONS

##### 1. RECOMMENDED OPTION

Call your authorized Chrysler / Dodge / Jeep® / RAM Dealership

##### 2. Call the FCA Recall Assistance

Center at **1-800-853-1403**. An agent can confirm part availability and help schedule an appointment

##### 3. Visit [recalls.mopar.com](http://recalls.mopar.com), scan the

QR code below, or download the Mopar Owner's Companion App.

QR Code

Get access to recall notifications, locate your nearest dealer, and more through this website or Mopar Owner's Companion App. You will be asked to provide your Vehicle Identification Number (VIN) to protect and verify your identity. The last eight characters of your VIN are provided above.

#### DEALERSHIP INSTRUCTIONS

Please reference Safety Recall W09.

# IMPORTANT SAFETY RECALL

## Driver Air Bag Emblem

Dear [Name],

This notice is sent to you in accordance with the National Traffic and Motor Vehicle Safety Act.

FCA US has decided that a defect, which relates to motor vehicle safety, exists in certain [2008 through 2010 Model Year (RT) Chrysler Town & Country and Dodge Grand Caravan and also 2007 through 2011 Model Year (KA) Dodge Nitro] vehicles equipped with a Driver Air Bag (DAB).

It is extremely important to take steps now to repair your vehicle to ensure the safety of you and your passengers.

#### WHY DOES MY VEHICLE NEED REPAIRS?

The DAB emblem on your vehicle <sup>[1]</sup> may have become loose or detached which may result in either the emblem or retainers, or both, not remaining attached to the DAB cover during DAB deployment. **A loose or detached emblem or emblem retainer can become a potential projectile during a crash with DAB deployment, which increases the risk of occupant injury.**

#### HOW DO I RESOLVE THIS IMPORTANT SAFETY ISSUE?

FCA US will repair your vehicle <sup>[2]</sup> free of charge (parts and labor). To do this, your dealer will inspect the DAB cover emblem retainers. If the emblem retainers are securely attached, your dealer will apply tape over the emblem retainers on the inside of the DAB cover to remedy the vehicle. If the emblem retainers are loose or broken, your dealer will remove the emblem from the DAB cover, which will remedy the safety concern. If the emblem is removed, once new DAB covers with emblem become available, you will receive another notification letter advising you to return to your dealer at a later date to have that installed. The estimated repair time is 30 minutes. In addition, your dealer will require your vehicle for proper check-in, preparation, and check-out during your visit, which may require more time. Your time is important to us, so we recommend that you schedule a service appointment to minimize your inconvenience. Please bring this letter with you to your dealership.

**TO SCHEDULE YOUR FREE REPAIR,  
CALL YOUR CHRYSLER, DODGE, JEEP OR RAM DEALER TODAY**

**VISIT [RECALLS.MOPAR.COM/HELP](http://RECALLS.MOPAR.COM/HELP) FOR MORE INFORMATION AND  
ANSWERS TO FREQUENTLY ASKED QUESTIONS**

#### WHAT IF I ALREADY PAID TO HAVE THIS REPAIR COMPLETED?

If you have already experienced this specific condition and have paid to have it repaired, you may visit [www.fcarecallreimbursement.com](http://www.fcarecallreimbursement.com) to submit your reimbursement request online. <sup>[3]</sup> Once we receive and verify the required documents, reimbursement will be sent to you within 60 days. If you have had previous repairs performed and/or already received reimbursement, you may still need to have the recall repair performed.

We apologize for any inconvenience, but are sincerely concerned about your safety. Thank you for your attention to this important matter.

Customer Assistance/Field Operations  
FCA US LLC



**Mr. Mrs. Customer**  
**1234 Main Street**  
**Hometown, MI 48371**

[1] If you no longer own this vehicle, please help us update our records. Call the FCA Recall Assistance Center at 1-800-853-1403 to update your information.

[2] If your dealer fails or is unable to remedy this defect without charge and within a reasonable time, you may submit a written complaint to the Administrator, National Highway Traffic Safety Administration, 1200 New Jersey Ave., S.E., Washington, DC 20590, or you can call the toll-free Vehicle Safety Hotline at 1-888-327-4236 (TTY 1-800-424-9153), or go to [safercar.gov](http://safercar.gov).

[3] You can also mail in your original receipts and proof of payment to the following address for reimbursement consideration: FCA Customer Assistance, P.O. Box 21-8004, Auburn Hills, MI 48321-8007, Attention: Recall Reimbursement.

Note to lessors receiving this recall notice: Federal regulation requires that you forward this recall notice to the lessee within 10 days.

This notice applies to your vehicle,

[Model Year and Model]

VIN XXXXXXXXXXXXXXXXXXXX

W09/NHTSA 20V-396

LOGO

VEHICLE PICTURE

#### YOUR SCHEDULING OPTIONS

**1. RECOMMENDED OPTION**

Call your authorized Chrysler / Dodge / Jeep® / RAM Dealership

**2. Call the FCA Recall Assistance Center at 1-800-853-1403. An agent can confirm part availability and help schedule an appointment**

**3. Visit recalls.mopar.com, scan the QR code below, or download the Mopar Owner's Companion App.**

QR Code

Get access to recall notifications, locate your nearest dealer, and more through this website or Mopar Owner's Companion App. You will be asked to provide your Vehicle Identification Number (VIN) to protect and verify your identity. The last eight characters of your VIN are provided above.

#### DEALERSHIP INSTRUCTIONS

Please reference Safety Recall W09.

# IMPORTANT SAFETY RECALL

## Driver Air Bag Emblem

Dear [Name],

This notice is sent to you in accordance with the National Traffic and Motor Vehicle Safety Act.

FCA has decided that a defect, which relates to motor vehicle safety, exists in certain [2008 through 2010 Model Year (RT) Chrysler Town & Country and Dodge Grand Caravan and also 2007 through 2011 Model Year (KA) Dodge Nitro] vehicles equipped with a Driver Air Bag (DAB).

FCA US LLC mailed interim safety recall notices in August 2020 notifying owners. The DAB emblem on your vehicle <sup>[1]</sup> may have become loose or detached which may result in either the emblem or retainers, or both, not remaining attached to the DAB cover during DAB deployment. A loose or detached emblem or emblem retainer can become a potential projectile during a crash with DAB deployment, which increases the risk of occupant injury.

During the interim repair, the dealer removed the emblem from the DAB cover. Because of this, the risk of injury from a detached emblem or retainers has been eliminated. You will receive a Customer Satisfaction Notification at a later date once new DAB covers with emblem become available. At that time, you will need to return to the dealer to have your new DAB cover with emblem installed. Please watch for the Customer Satisfaction Notification in your mailbox.

If you have questions or concerns, which your dealer is unable to resolve, please contact the FCA Group Recall Assistance Center at either [fcarecalls.com](http://fcarecalls.com) or 1 800-853-1403.

We apologize for any inconvenience this error may have caused.

Thank you for your attention to this important matter.

Customer Assistance/Field Operations  
Fiat Chrysler Automobiles US LLC



**Mr. Mrs. Customer**  
**1234 Main Street**  
**Hometown, MI 48371**

[1] If you no longer own this vehicle, please help us update our records. Call the FCA Recall Assistance Center at 1-800-853-1403 to update your information.

Note to lessors receiving this recall notice: Federal regulation requires that you forward this recall notice to the lessee within 10 days.