



David J. Johnson
Director
Service Engineering Operations
Ford Customer Service Division

Ford Motor Company
P. O. Box 1904
Dearborn, Michigan 48121

July 28, 2020

TO: All U.S. Ford and Lincoln Dealers

SUBJECT: Safety Recall 20S30

Certain 2011-2014 Fiesta, 2013-2014 Fusion and MKZ, 2013-2015 C-MAX and Escape, 2012-2015 Focus, 2015 MKC and Mustang, and 2014-2016 Transit Connect Vehicles
Side Door Latch Previously Repaired Under 15S16 or 16S30

AFFECTED VEHICLES

Vehicle	Model Year	Assembly Plant	Build Dates
Fiesta	2011-2014	Cuautitlan	January 26, 2010 through October 31, 2013
Fusion	2014	Flat Rock	June 18, 2013 through October 31, 2013
Fusion	2013-2014	Hermosillo	May 11, 2012 through October 31, 2013
MKZ	2013-2014	Hermosillo	July 19, 2012 through October 31, 2013
Mustang	2015	Flat Rock	February 14, 2014 through April 30, 2015
Escape	2013-2015	Louisville	December 23, 2011 through January 31, 2015
MKC	2015	Louisville	November 18, 2013 through January 31, 2015
C-Max	2013-2015	Michigan	February 2, 2012 through January 31, 2015
Focus	2012-2015	Michigan	October 4, 2010 through January 31, 2015
Transit Connect	2014-2016	Valencia (Spain)	August 9, 2013 through February 1, 2016

Affected vehicles are identified in OASIS and FSA VIN Lists.

REASON FOR THIS SAFETY RECALL

Ford Motor Company has determined that some vehicles claimed by dealers as repaired under Safety Recalls 15S16 & 16S30 did not receive the claimed repairs, or the repair may not have been completed properly. If a vehicle did not receive the claimed repairs, the door latches have a pawl spring tab that may break. This condition will typically prevent the door from latching. If the customer is able to latch the door after repeated attempts to shut the door, there is potential the door may unlatch while driving, increasing the risk of injury.

OWNER SELF INSPECTION

Owners will be given the option to inspect their vehicle's door latch date codes and enter the data using Ford's Customer Site, which will determine if a prior recall repair was properly completed. Alternatively, they can take their vehicle to a Ford or Lincoln dealer for inspection under Safety Recall 20S30.

OWNER SELF INSPECTION, continued

NOTE: Dealers are not to use the Customer Site to confirm latch information. Instead, dealers are to utilize the Dealer Site indicated in the SERVICE ACTION section, which allows for FSA claim approval codes to be issued for FSA claiming.

All latch confirmation attempts by both customers and dealers are recorded by VIN, date, and attempt number, and are subject to review.

SERVICE ACTION

For customers who are unable to receive confirmation of their vehicle's latch date codes using the customer website, or who prefer not to inspect their vehicle, dealers are to inspect all affected door latches and submit date codes for review using Ford's Dealer Site at dealer.fordlatchrecall.com.

Any vehicle found to have factory installed door latches will require replacement of all door latches as directed by Ford Motor Company. This service must be performed on all affected vehicles at no charge to the vehicle owner.

OWNER NOTIFICATION MAILING SCHEDULE

Owner letters are expected to be mailed beginning the week of July 27, 2020. Dealers should inspect any affected vehicles that arrive at their dealerships, whether or not the customer has received a letter.

PLEASE NOTE:

Federal law requires dealers to complete this recall service before a new vehicle is delivered to the buyer or lessee. Violation of this requirement by a dealer could result in a civil penalty of up to \$21,000 per vehicle. Correct all vehicles in your new vehicle inventory before delivery.

ATTACHMENTS

Attachment I: Administrative Information
Attachment II: Labor Allowances and Parts Ordering Information
Attachment III: Inspection Instructions
Attachment IV: Repair Instructions – Fiesta, Fusion, MKZ
Attachment V: Repair Instructions – All Other Vehicles
Attachment VI: SSSC Approval Types and Contact Preparation
Owner Notification Letters
Recall Reimbursement Plan

QUESTIONS & ASSISTANCE

For questions and assistance, contact the Special Service Support Center (SSSC) via the SSSC Web Contact Site. The SSSC Web Contact Site can be accessed through the Professional Technician Society (PTS) website using the SSSC link listed at the bottom of the OASIS VIN report screen or listed under the SSSC tab.

Sincerely,



David J. Johnson

Safety Recall 20S30

Certain 2011-2014 Fiesta, 2013-2014 Fusion and MKZ, 2013-2015 C-MAX and Escape, 2012-2015 Focus, 2015 MKC and Mustang, and 2014-2016 Transit Connect Vehicles
Side Door Latch Previously Repaired Under 15S16 or 16S30

OASIS ACTIVATION

OASIS was activated on June 9, 2020.

FSA VIN LISTS ACTIVATION

FSA VIN Lists were available through <https://web.fsavinlists.dealerconnection.com> on June 9, 2020. Owner names and addresses will be available by August 21, 2020.

NOTE: Your FSA VIN Lists may contain owner names and addresses obtained from motor vehicle registration records. The use of such motor vehicle registration data for any purpose other than in connection with this recall is a violation of law in several states, provinces, and countries. Accordingly, you must limit the use of this listing to the follow-up necessary to complete this recall.

SOLD VEHICLES

Ford has not issued instructions to stop selling/delivering or driving used vehicles under this safety recall. Owners should inspect their vehicles or contact their dealer for an appointment to have their vehicles remedied as soon as practicable. Owners can continue to safely drive their vehicles if they ensure the doors are securely latched without using excessive effort before driving.

- Immediately contact any of your affected customers whose vehicles are not on your VIN list but are identified in OASIS. Give the customer a copy of the Owner Notification Letter (when available) and schedule a service date.
- Correct other affected vehicles identified in OASIS which are brought to your dealership.
- Dealers are to prioritize repairs of customer vehicles over repairs of new and used vehicle inventory.

STOCK VEHICLES

Use OASIS to identify any affected vehicles in your used vehicle inventory.

DEALER-OPERATED RENTAL VEHICLES

The Fixing America's Surface Transportation (FAST) Act law effective June 2016 prohibits a rental company from selling, renting or leasing vehicles subject to a safety or compliance recall. Please consult your legal counsel for legal advice.

TITLE BRANDED / SALVAGED VEHICLES

Affected title branded and salvaged vehicles are eligible for this recall.

Safety Recall 20S30

Certain 2011-2014 Fiesta, 2013-2014 Fusion and MKZ, 2013-2015 C-MAX and Escape, 2012-2015 Focus, 2015 MKC and Mustang, and 2014-2016 Transit Connect Vehicles
Side Door Latch Previously Repaired Under 15S16 or 16S30

OWNER REFUNDS

- Claiming a refund will not close the recall on the vehicle. The vehicle will still be subject to an inspection and repair, if needed.
- Ford Motor Company is offering a refund for owner-paid repairs covered by this recall if the repair was performed prior to the date indicated in the reimbursement plan, which is posted with this bulletin. Owners are directed to seek reimbursement through authorized dealers or, at their option, directly through Ford Motor Company at P.O. Box 6251, Dearborn, MI 48121-6251.
- Dealers are also pre-approved to refund owner-paid emergency repairs that were performed away from an authorized servicing dealer after the end date specified in the reimbursement plan. Non-covered repairs, or those judged by Ford to be excessive, will not be reimbursed.
- Refunds will only be provided for the cost associated with door latch replacements performed after repairs were claimed under 15S16 or 16S30.

RENTAL VEHICLES

With proper dealer parts ordering and service appointment scheduling, rental vehicles should not be required. However, if you have a unique owner circumstance which may require a rental vehicle, please contact the SSSC via the SSSC Web Contact Site.

ADDITIONAL REPAIR (LABOR TIME AND/OR PARTS)

Additional repairs identified as necessary to complete the FSA should be managed as follows:

- For related damage and access time requirements, refer to the Warranty and Policy Manual / Section 6 – Ford & Lincoln Program Policies / General Information & Special Circumstances for FSA's / Related Damage.
- For vehicles within new vehicle bumper-to-bumper warranty coverage, no SSSC approval is required, although related damage must be on a separate repair line with the "Related Damage" radio button checked.
 - Ford vehicles – 3 years or 36,000 miles
 - Lincoln vehicles – 4 years or 50,000 miles
- For vehicles outside new vehicle bumper-to-bumper warranty coverage, submit an Approval Request to the SSSC Web Contact Site prior to completing the repair.

Safety Recall 20S30

Certain 2011-2014 Fiesta, 2013-2014 Fusion and MKZ, 2013-2015 C-MAX and Escape, 2012-2015 Focus, 2015 MKC and Mustang, and 2014-2016 Transit Connect Vehicles
Side Door Latch Previously Repaired Under 15S16 or 16S30

CLAIMS PREPARATION AND SUBMISSION

- **Approval Codes**
 - All repairs under 20S30 will require an approval code for claim submission. Refer to Attachment VI to better understand approval types and for best practices when submitting SSSC contacts for approval under this recall.
 - For door latch date codes that are confirmed using Ford's Dealer Site, the approval code will require RO NUMBER, RO LINE, and RO OPEN DATE
 - For vehicles that require door latch replacements, all information listed above will be required in addition to door latch date codes and photo documentation. Additional information may be requested by the SSSC.
 - Dealers are responsible for the accuracy of all information submitted in contacts.
- **Claim Entry:** Enter claims using Dealer Management System (DMS) or One Warranty Solution (OWS) online.
 - When entering claims, select claim type 31: Field Service Action. The FSA number 20S30 is the sub code.
 - For additional claims preparation and submission information, refer to the Recall and Customer Satisfaction Program (CSP) Repairs in the OWS User Guide.
 - The required approval code must be submitted on the program line. It is not to be used for related damage lines.
- **Related Damage/Additional labor and/or parts:** Must be claimed as Related Damage on a separate repair line from the FSA with same claim type and sub code as described in Claim Entry above.

IMPORTANT: Click the Related Damage Indicator radio button.
- **Rentals (if approved):** For rental vehicle claiming, follow Extended Service Plan (ESP) guidelines for dollar amounts. Enter the total amount of the rental expense under Miscellaneous Expense code RENTAL.
- **Refunds:** Submit refunds on a separate repair line.
 - Program Code: 20S30
 - Misc. Expense: ADMIN
 - Misc. Expense: REFUND
 - Misc. Expense: 0.2 Hrs.
 - Multiple refunds should be submitted on one repair line and the invoice details for each repair should be detailed in the comments section of the claim.

Safety Recall 20S30

Certain 2011-2014 Fiesta, 2013-2014 Fusion and MKZ, 2013-2015 C-MAX and Escape, 2012-2015 Focus, 2015 MKC and Mustang, and 2014-2016 Transit Connect Vehicles
Side Door Latch Previously Repaired Under 15S16 or 16S30

LABOR ALLOWANCES

Description	Labor Operation	Labor Time
Inspect Only (all latches confirmed) <ul style="list-style-type: none"> includes time to inspect latches, enter date code information for review, and submit for prior approval via the SSSC Web Contact Site Closes the FSA and <u>may not be combined with any other labor operation</u> 	20S30A	0.4 Hours
Administrative time to: <ul style="list-style-type: none"> submit photos and date codes of original door latches bench test inspect and record new latch date codes obtain service manager sign off on the R.O. upload photos and survey responses Claim in addition to ONE of the appropriate labor operations listed below.	20S30BB	1.3 Hours
Replace all four door latches – 2011-2014 Fiesta	20S30C	1.5 Hours
Replace all four door latches – 2013-2014 Fusion/MKZ	20S30D	1.8 Hours
Replace both side door latches – Mustang	20S30E	1.3 Hours
Replace both sliding door latches – Transit Connect	20S30F	1.0 Hours
Replace all four side door latches – C-MAX	20S30G	1.5 Hours
Replace all four side door latches – Focus	20S30H	1.5 Hours
Replace all four side door latches – Escape	20S30J	1.4 Hours
Replace all four side door latches – MKC	20S30K	1.5 Hours

PARTS REQUIREMENTS / ORDERING INFORMATION

Latch Kit Table – Fiesta, Fusion and MKZ

Part Number	Description	Order Quantity	Claim Quantity
DE8Z-54264A26-B	Fiesta with Keyless Entry Door Latch Kit (contains 4 latches)	1	1
DE8Z-54264A26-A	Fiesta without Keyless Entry* Door Latch Kit (contains 4 latches)	1	1
DS7Z-54264A26-A	Fusion and MKZ Door Latch Kit (contains 4 latches)	1	1

*Fiesta vehicles without Keyless Entry are equipped with a lock cylinder in the passenger front door.

Safety Recall 20S30

Certain 2011-2014 Fiesta, 2013-2014 Fusion and MKZ, 2013-2015 C-MAX and Escape, 2012-2015 Focus, 2015 MKC and Mustang, and 2014-2016 Transit Connect Vehicles
Side Door Latch Previously Repaired Under 15S16 or 16S30

PARTS REQUIREMENTS / ORDERING INFORMATION (continued)

Latch Kit Table – All Other Vehicles

Part Number	Description	Order Quantity	Claim Quantity
CJ5Z-54264A26-A	C-MAX / Escape / 2012-2014 Focus / MKC Door Latch Kit (contains 4 latches)	1	1
CJ5Z-54264A26-B	2015 Focus Door Latch Kit (contains 4 latches)	1	1
CJ5Z-54264A26-C	Mustang Door Latch Kit (contains 2 latches)	1	1
CJ5Z-54264A26-D	Transit Connect Door Latch Kit (contains 2 latches)	1	1

DEALER PRICE

For latest prices, refer to DOES II.

PARTS RETENTION AND RETURN

Follow the provisions of the Warranty and Policy Manual, Section 1 - WARRANTY PARTS RETENTION AND RETURN POLICIES.

EXCESS STOCK RETURN

Excess stock returned for credit must have been purchased from Ford Customer Service Division in accordance with Policy Procedure Bulletin 4000.

CERTAIN 2011-2014 FIESTA, 2013-2014 FUSION AND MKZ, 2013-2015 C-MAX AND ESCAPE, 2012-2015 FOCUS, 2015 MKC AND MUSTANG, AND 2014-2016 TRANSIT CONNECT VEHICLES — SIDE DOOR LATCH PREVIOUSLY REPAIRED UNDER 15S16 OR 16S30

SERVICE PROCEDURE

1. Determine if the vehicle has any door latching symptoms. Proceed to Step 2.
2. Inspect and record the date code located on all affected latches. See Figure 1.
 - Mustang - two side doors
 - Transit Connect - two sliding doors
 - All other vehicles - all four doors

NOTE: If there is grease or debris covering the door latch build date, use a shop rag to wipe away the grease prior to taking the picture.

NOTE: Date code style and orientation may vary. Date codes can be from 4 to 7 alphanumeric characters.



FIGURE 1



NOTE: This step is only to be performed on the rear doors and is not required for Mustang and Transit Connect vehicles.

3. Inspect and record if the rear door latch has the presence of a child lock as evidenced by a white slotted circle. See Figure 2

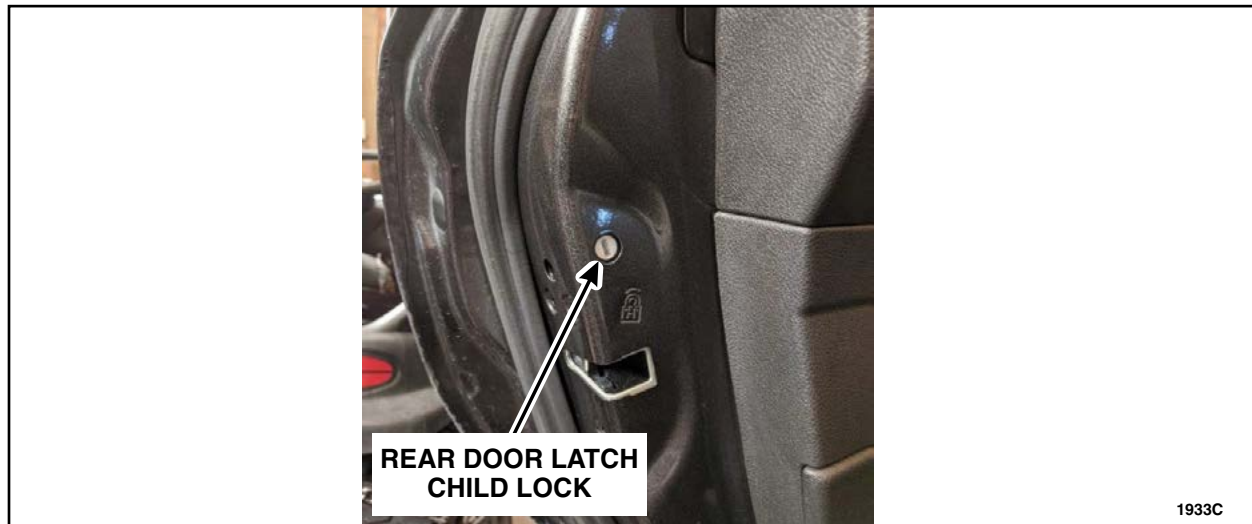

FIGURE 2

4. Enter latch information using the Dealer Site at dealer.fordlatchrecall.com.

NOTE: Dealers are not to use the Customer Site to confirm latch information, as this will prevent dealer FSA claims from being processed.

NOTE: Use care when entering latch code information. All latch confirmation attempts by both customers and dealers are recorded by VIN, date, and attempt number, and are subject to review.

- If all door latch codes are confirmed and there are no door latching symptoms on the vehicle, submit a Dealer Self Service contact.
- If one or more latches cannot be confirmed, or the vehicle is missing a child safety lock, submit a Date Code Review contact.
- If the vehicle is exhibiting door latching symptoms, submit a Failed Latch Review contact.

NOTE: Refer to Attachment VI for more information regarding SSSC approvals and best practices.



CERTAIN 2011-2014 FIESTA, 2013-2014 FUSION AND MKZ, 2013-2015 C-MAX AND ESCAPE, 2012-2015 FOCUS, 2015 MKC AND MUSTANG, AND 2014-2016 TRANSIT CONNECT VEHICLES - SIDE DOOR LATCH PREVIOUSLY REPAIRED UNDER 15S16 OR 16S30

SERVICE PROCEDURE

1. Open the driver's side front door. Take a picture of the Vehicle Identification Number (VIN) sticker on the lower A-pillar. This picture will need to be submitted in the Special Service Support Center (SSSC) web questionnaire.

NOTE: Latch date code can be comprised of numbers or letters 4-7 characters in length.

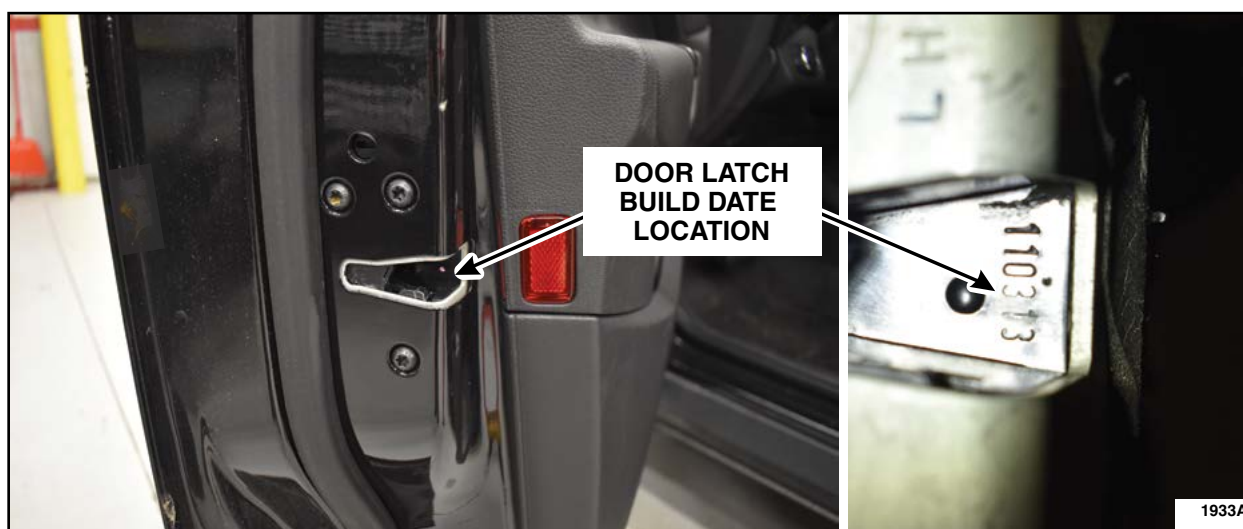





FIGURE 1

NOTE:

- To view a video demonstrating the removal and installation of the exterior door handle while installed on the vehicle, click the video icon. 
- To view a video demonstrating the removal and installation of the exterior door handle on a bench for additional clarity, click the video icon. 
- If you experience difficulty removing and/or installing the exterior door handle, you may need to reset the door handle reinforcement. To view a video that will aid technicians in understanding how to reset the door handle reinforcement, or to further understand how the exterior door handle and door reinforcement function, click the video icon. 



FUSION, MKZ AND FIESTA VEHICLES

NOTE: Videos demonstrating the complete repairs can be found below.

Fusion/MKZ  **Fiesta** 

1. Replace all four door latches. For additional information, refer to Workshop Manual (WSM) Section 501-14.
2. As each old door latch is removed, perform the Door Latch Functionality Bench Test on page 4.
3. When repairs are complete, verify the presence of a child lock in each of the rear door latches. See Figure 2.

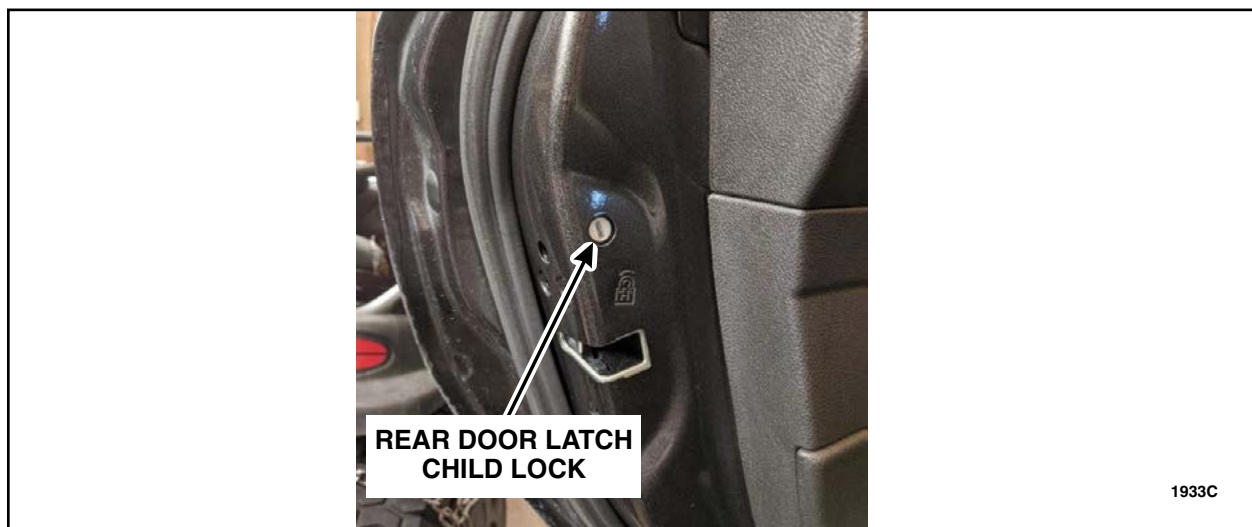

FIGURE 2



4. Once the **new** latches have been installed in the vehicle, record all four date codes of the new latches. Additionally, capture a picture of the date code of each new door latch (four pictures total) showing them installed in the vehicle. These pictures will need to be submitted in the SSSC web questionnaire. See Figure 3.

NOTE: If there is grease or debris covering the door latch build date, use a shop rag to wipe away the grease prior to taking the picture.

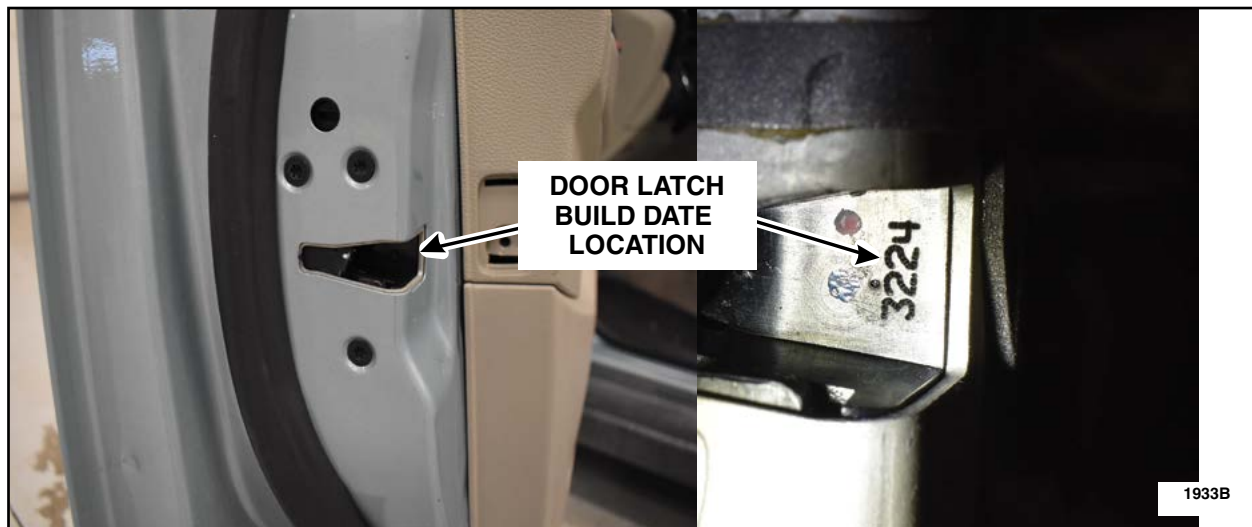

FIGURE 3

5. The service manager must inspect the vehicle to confirm that repairs were completed. Obtain service manager sign-off on the repair order. This will be need to be submitted in the SSSC web questionnaire (image, scan, or PDF).
6. Update your SSSC approval contact with the photo of the VIN, the new latch date codes, the images of the new latches installed in the vehicle (clearly reflecting the latch date codes), and the Service Manager sign-off.



Door Latch Functionality Bench Test

NOTE: Once the door latches have been removed, perform the Door Latch Functionality Bench Test. Record the data for use in the SSSC web questionnaire.

NOTE: Video demonstrating the complete Door Latch Functionality Bench Test can be found below. Rear door latch shown, Front door latch similar.

Bench Test 

1. Using a suitable screwdriver, insert and engage the door latch mechanism. See Figure 4.

NOTE: Rear door latch shown, Front door latch similar.



FIGURE 4

2. Turn the door latch on its side, and slide the interior handle release lever to release the latching mechanism. See Figure 5.



FIGURE 5



3. With the interior handle release lever engaged, place screwdriver back in the latch and verify that the latch releases. See Figure 6.



FIGURE 6

4. Re-engage the latch with the screwdriver. See Figure 4.

5. After the latch has been placed in the latched position, take a second screwdriver and actuate the exterior handle release lever. See Figure 7.

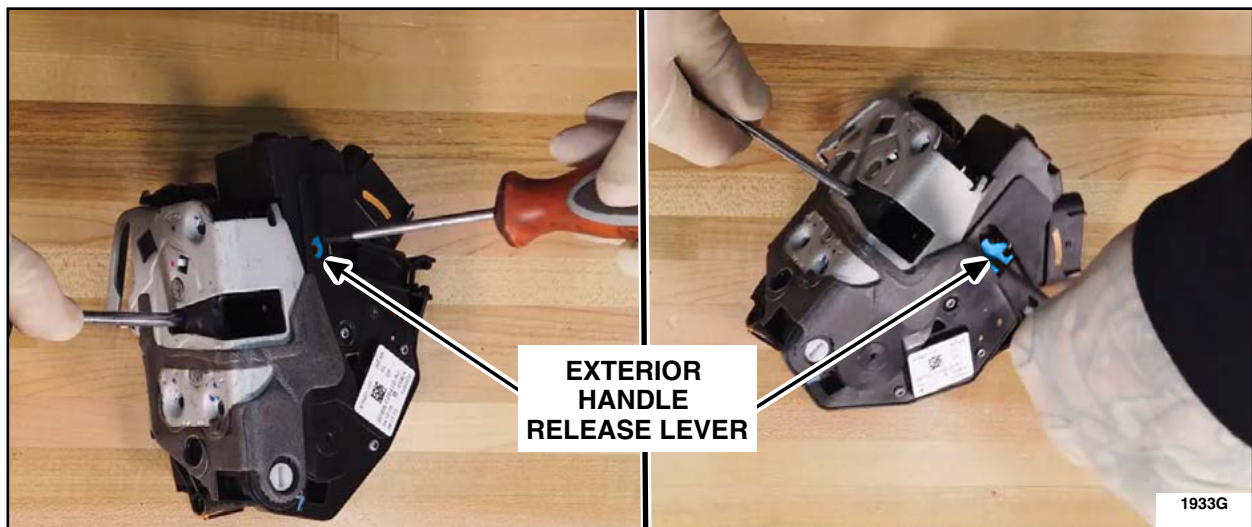

FIGURE 7



6. With the exterior handle release lever engaged, verify that the latch releases. See Figure 8.



FIGURE 8



CERTAIN 2011-2014 FIESTA, 2013-2014 FUSION AND MKZ, 2013-2015 C-MAX AND ESCAPE, 2012-2015 FOCUS, 2015 MKC AND MUSTANG, AND 2014-2016 TRANSIT CONNECT VEHICLES- SIDE DOOR LATCH PREVIOUSLY REPAIRED UNDER 15S16 OR 16S30

SERVICE PROCEDURE

NOTE: Videos demonstrating the complete repairs on Focus and Escape vehicles can be found below.

Focus  Escape 

- C-MAX, Escape, Focus, MKC - all four side door latches.
- Mustang - two side door latches.
- Transit Connect - two sliding door latches.

1. Open the driver's side front door. Take a picture of the Vehicle Identification Number (VIN) sticker on the lower A-pillar. This picture will need to be submitted in the Special Service Support Center (SSSC) web questionnaire.

NOTE: Latch date codes can be comprised of numbers or letters 4-7 characters in length.



FIGURE 1



IMPORTANT: If equipped, ensure that the blocking lever and blocking lever spring are transferred to the *new* door latch, along with all other components removed from the old door latch.
See Figure 2.



FIGURE 2

TABLE OF CONTENTS

C-MAX and Focus.....	Page 3
Escape and MKC	Page 5
Transit Connect	Page 7
Mustang.....	Page 12
Door Latch Functionality Bench Test.....	Page 14



C-MAX and Focus Vehicles

NOTE: For front door latch replacement, it is not necessary to remove the door modules, speakers, or water shield. To access components for removal, position aside the water shield as needed. See Figure 3.

1. Replace the front and rear side door latches. Please follow the Workshop Manual (WSM) procedures in Section 501-14.
2. As each old door latch is removed, perform the Door Latch Functionality Bench Test. See Page 14.



FIGURE 3

3. Verify the presence of a child lock in both rear doors. See Figure 4.

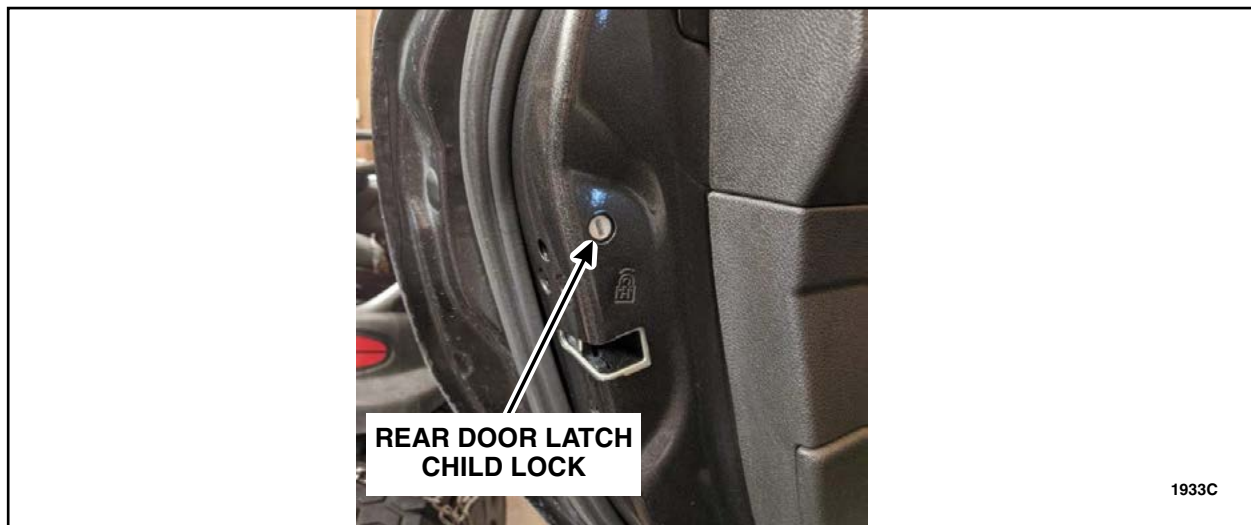

FIGURE 4



4. Once the new latches have been installed in the vehicle, record all four date codes of the new latches. Additionally, capture a picture of the date code of each new door latch (four pictures total) showing them installed in the vehicle. These pictures will need to be submitted on the SSSC web questionnaire. See Figure 5.

NOTE: If there is grease or debris covering the door latch build date, use a shop rag to wipe away the grease prior to taking the picture.

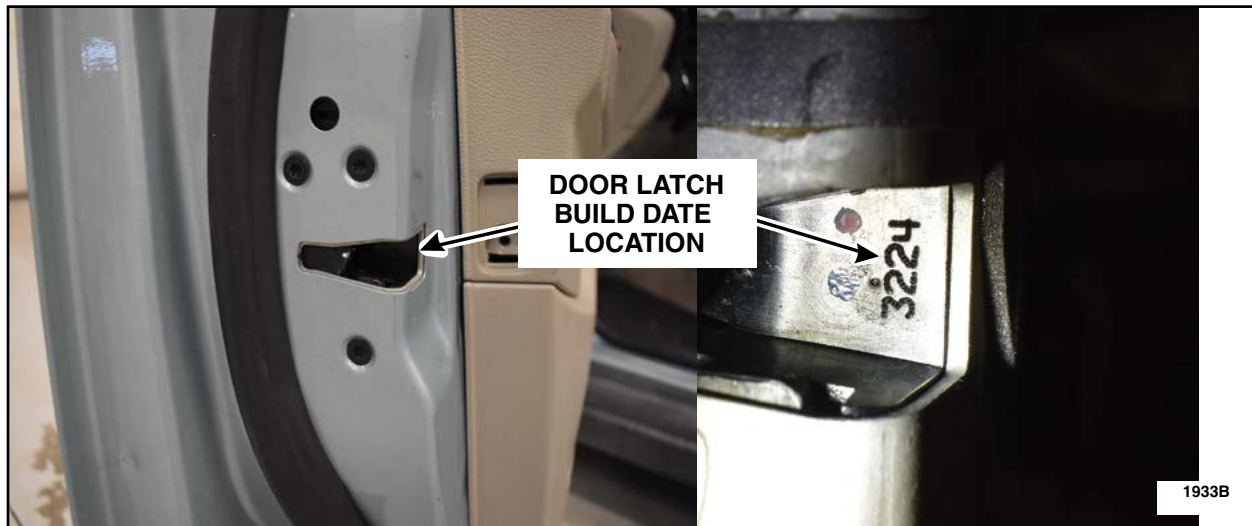

FIGURE 5

5. The service manager must inspect the vehicle to confirm that repairs were completed. Obtain service manager sign-off on the repair order. This will need to be submitted in the SSSC web questionnaire.
6. Update your SSSC approval contact with the photo of the VIN, the new latch date codes, the images of the new latches installed in the vehicle (clearly reflecting the latch date codes), and the Service Manager sign-off.



Escape and MKC Vehicles

NOTE: For front door latch replacement, it is not necessary to completely remove the window regulator. Remove the two bolts and position aside the outer portion of the window regulator. See Figure 6.

1. Replace the front and rear side door latches. Please follow the WSM procedures in Section 501-14.
2. As each old door latch is removed, perform the Door Latch Functionality Bench Test. See Page 14.

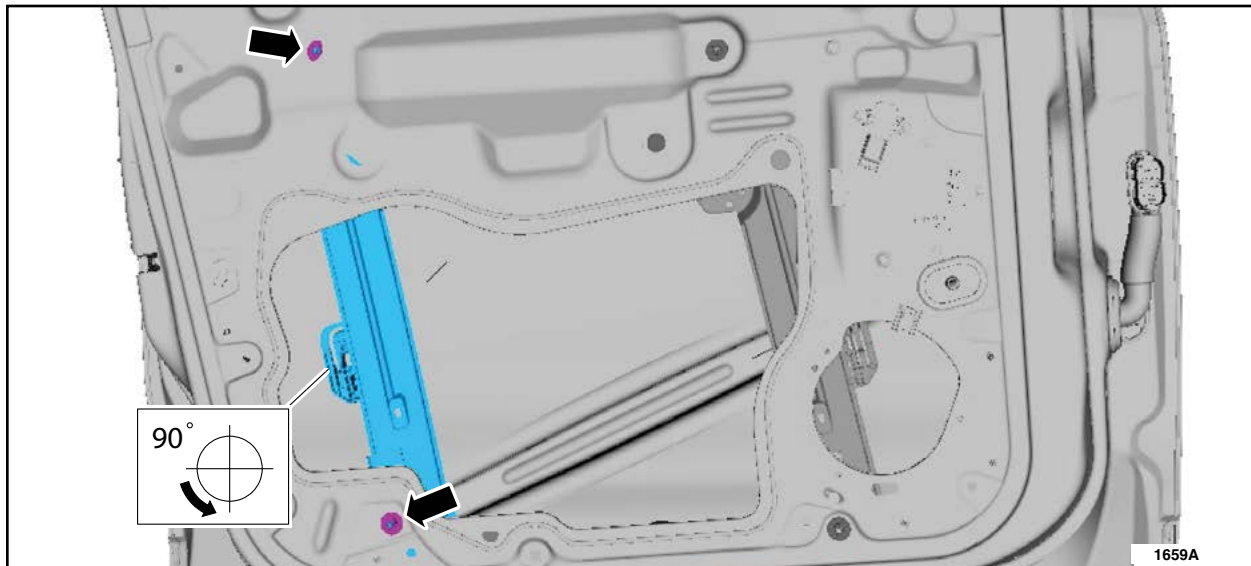

FIGURE 6

3. Verify the presence of a child lock in both rear doors. See Figure 7.



FIGURE 7



4. Once the **new** latches have been installed in the vehicle, record all four date codes of the new latches. Additionally, capture a picture of the date code of each new door latch (four pictures total) showing them installed in the vehicle. These pictures will need to be submitted on the SSSC web questionnaire. See Figure 8.

NOTE: If there is grease or debris covering the door latch build date, use a shop rag to wipe away the grease prior to taking the picture.

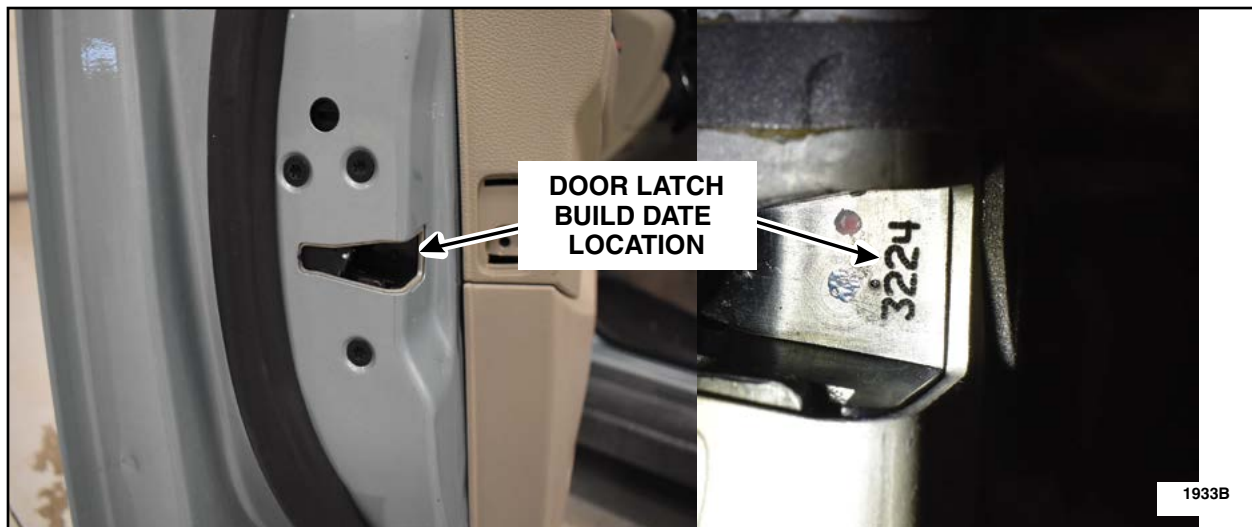

FIGURE 8

5. The service manager must inspect the vehicle to confirm that repairs were completed. Obtain service manager sign-off on the repair order. This will need to be submitted in the SSSC web questionnaire.
6. Update your SSSC approval contact with the photo of the VIN, the new latch date codes, the images of the new latches installed in the vehicle (clearly reflecting the latch date codes), and the Service Manager sign-off.



Transit Connect Vehicles

NOTE: Only the RH and LH sliding door latches are affected on Transit Connect Vehicles.

1. Remove the sliding door trim panel. Please follow the WSM procedures in Section 501-05.
2. Raise the sliding door glass to the full up position. See Figure 9.

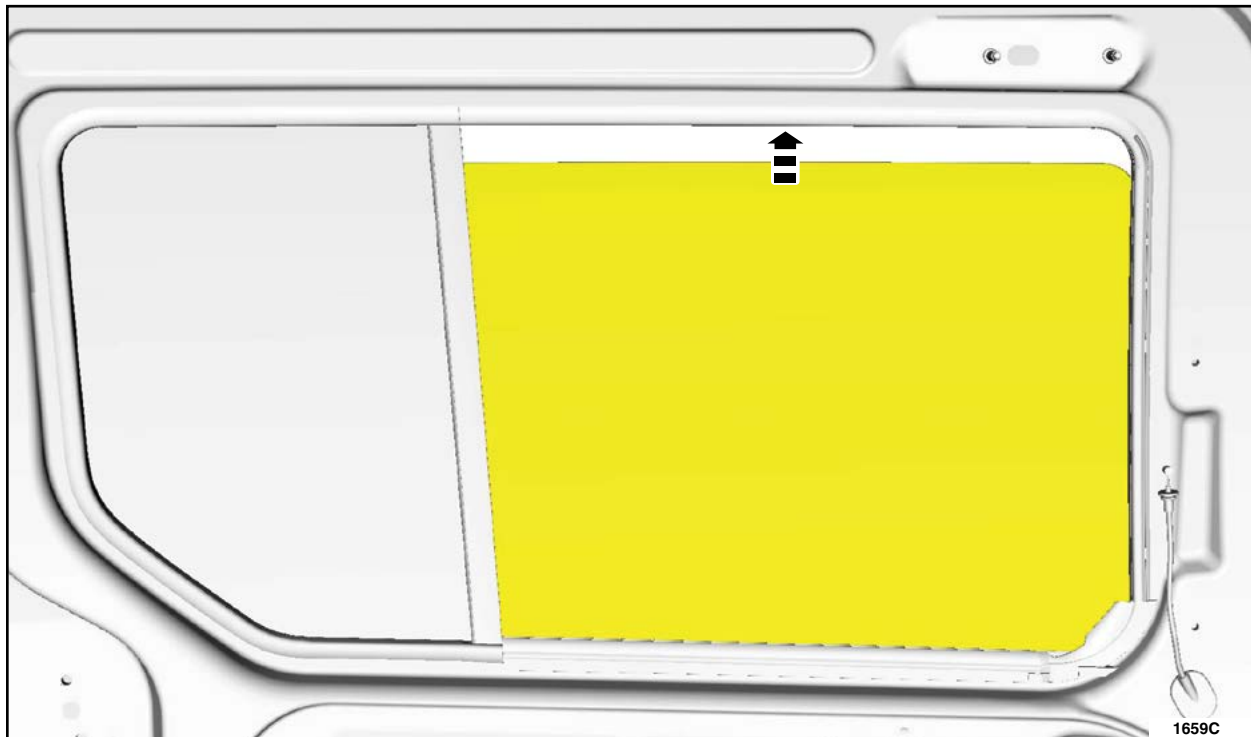

FIGURE 9



3. Remove the sliding door watershield using an interior trim remover tool. See Figure 10.

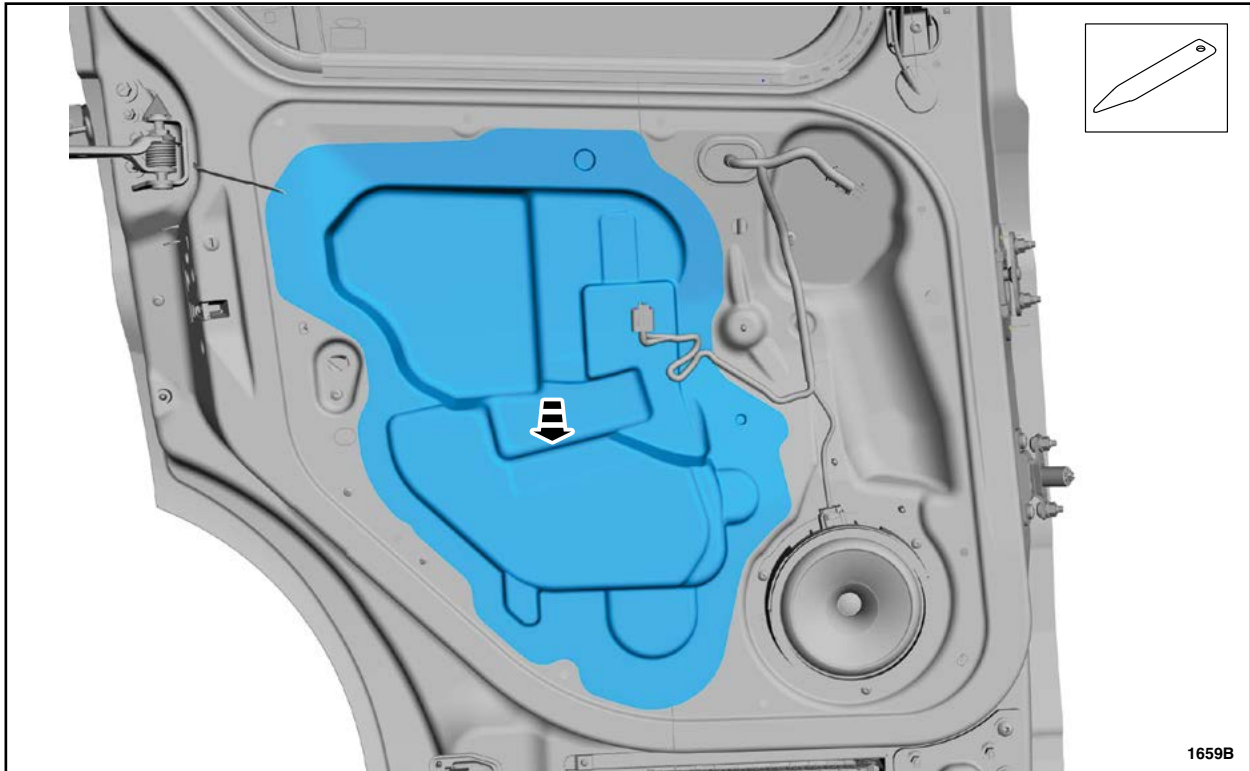

FIGURE 10

4. Remove the sliding door latch bolts. See Figure 11.

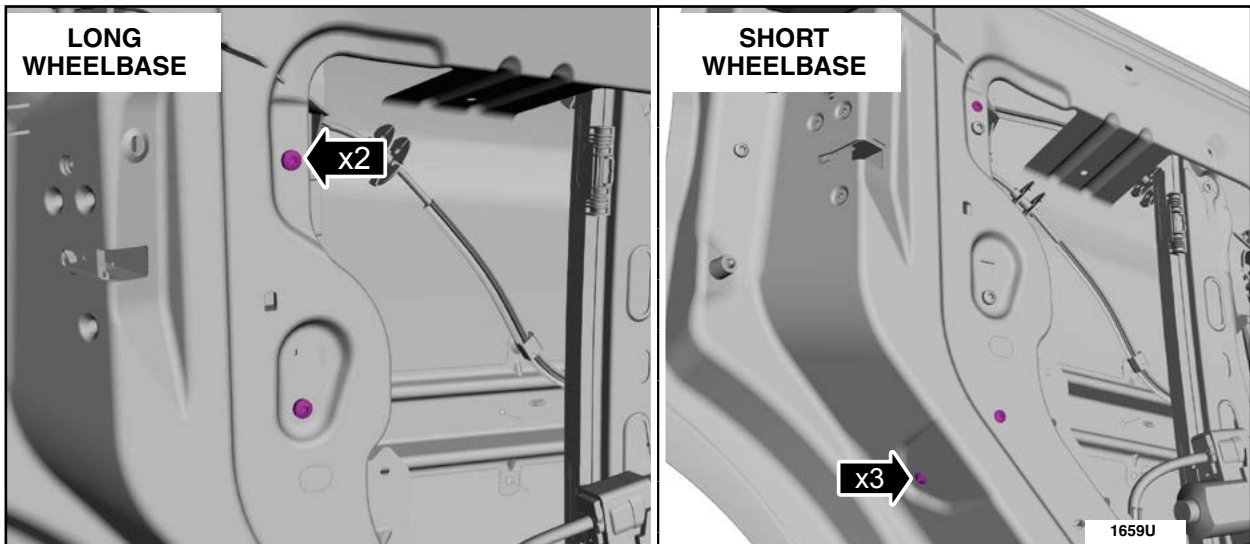

FIGURE 11



5. Remove the sliding door latch bolts. See Figure 12.

- Torque: 106 lb.in (12 Nm).

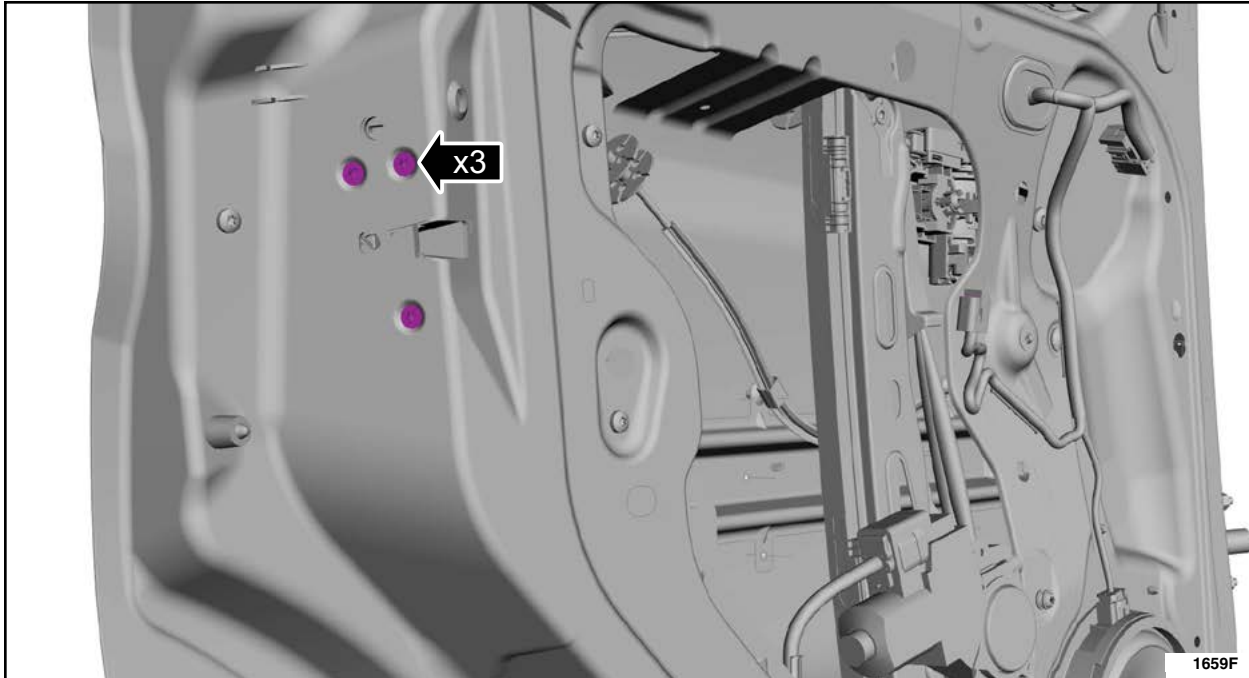

FIGURE 12

6. Disconnect the electrical connector from the sliding door latch. See Figure 13.

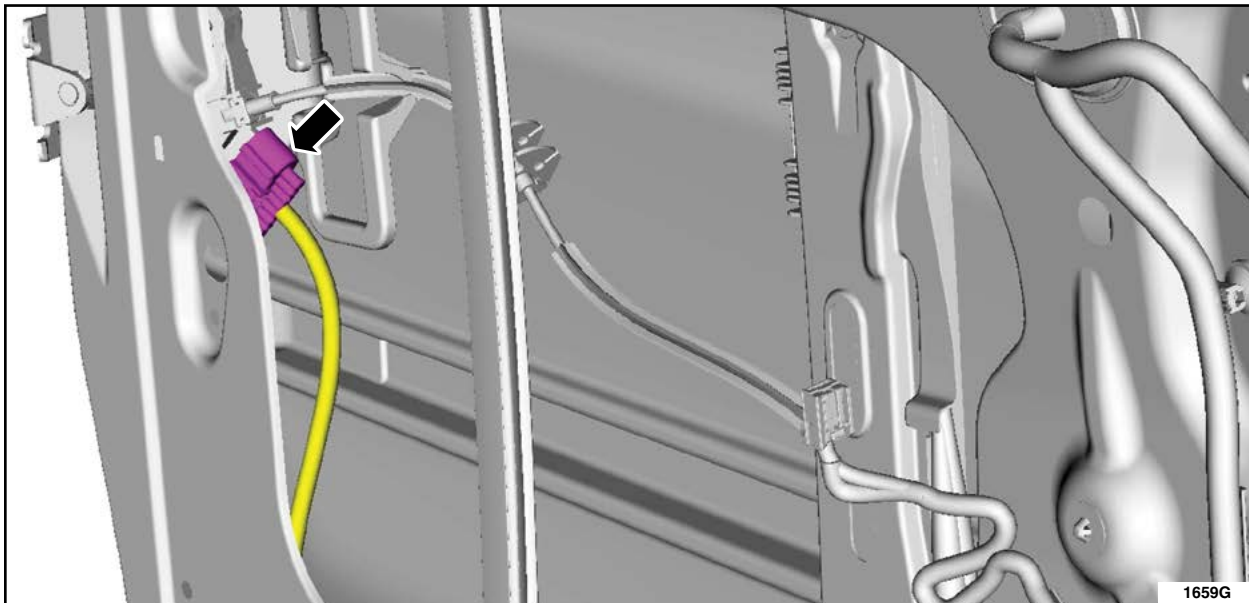

FIGURE 13



7. Position the sliding door latch out of the sliding door. See Figure 14.



FIGURE 14

8. Disconnect the interior and exterior sliding door latch cables. Remove and discard the sliding door latch. See Figure 15.

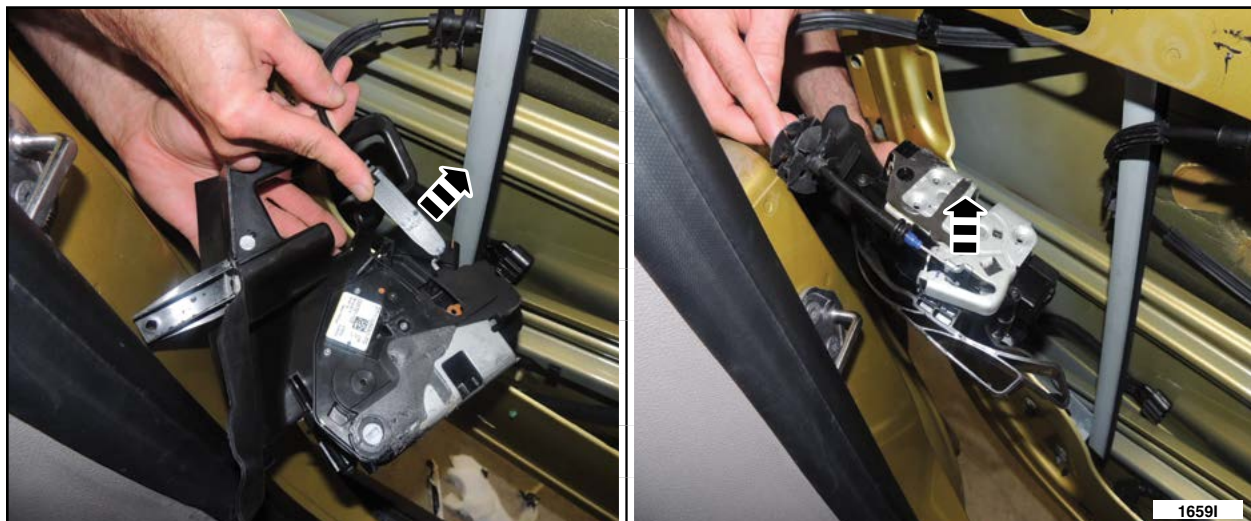

FIGURE 15

NOTE: When installing the *new* sliding door latches, align the child lock actuator with the slot in the sliding door before installing the sliding door latch bolts.

9. To install *new* sliding door latches, reverse the removal procedure.



10. As each old door latch is removed, perform the Door Latch Functionality Bench Test. See Page 14.
11. Once the **new** latches have been installed in the vehicle, record both date codes of the new latches. Additionally, capture a picture of the date code of each new door latch (two pictures total) showing them installed in the vehicle. These pictures will need to be submitted on the SSSC web questionnaire. See Figure 16.

NOTE: If there is grease or debris covering the door latch build date, use a shop rag to wipe away the grease prior to taking the picture.

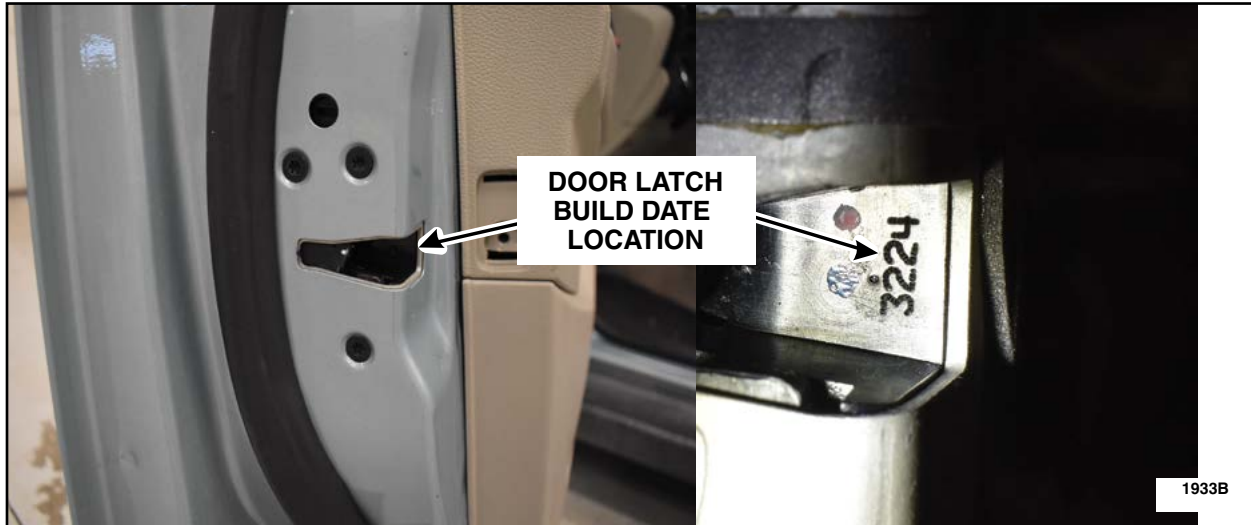

FIGURE 16

12. The service manager must inspect the vehicle to confirm that repairs were completed. Obtain service manager sign-off on the repair order. This will need to be submitted in the SSSC web questionnaire.
13. Update your SSSC approval contact with the photo of the VIN, the new latch date codes, the images of the new latches installed in the vehicle (clearly reflecting the latch date codes), and the Service Manager signoff.



Mustang Vehicles

NOTE: Use this procedure to service the side door latches.

1. Remove the front door trim panel. Please follow the WSM procedures in Section 501-05.
2. Align and apply masking tape or equivalent to window glass fore and aft along window seals as reference points for alignment during re-installation of the window glass. See Figure 17.

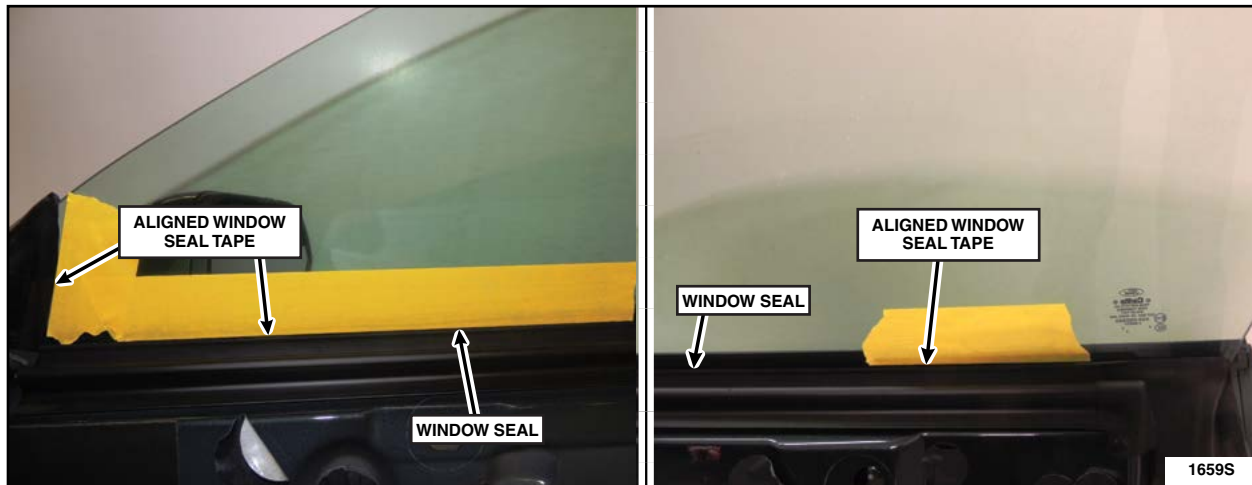

FIGURE 17

NOTE: BEFORE removing the fasteners, mark all of the fasteners for the aft front door glass run and front door window regulator with a paint pen or permanent marker. See Figure 18.

3. Replace both side door latches. Please follow the WSM procedures in Section 501-14.



FIGURE 18

NOTE: When reinstalling the window glass, align the tape with the window seal to ensure proper fit before tightening the fasteners. Door window glass adjustment is not necessary when following this procedure. See Figure 17.

4. As each old door latch is removed, perform the Door Latch Functionality Bench Test. See Page 14.



5. Once the **new** latches have been installed in the vehicle, record both date codes of the new latches. Additionally, capture a picture of the date code of each new door latch (two pictures total) showing them installed in the vehicle. These pictures will need to be submitted on the SSSC web questionnaire. See Figure 19.

NOTE: If there is grease or debris covering the door latch build date, use a shop rag to wipe away the grease prior to taking the picture.

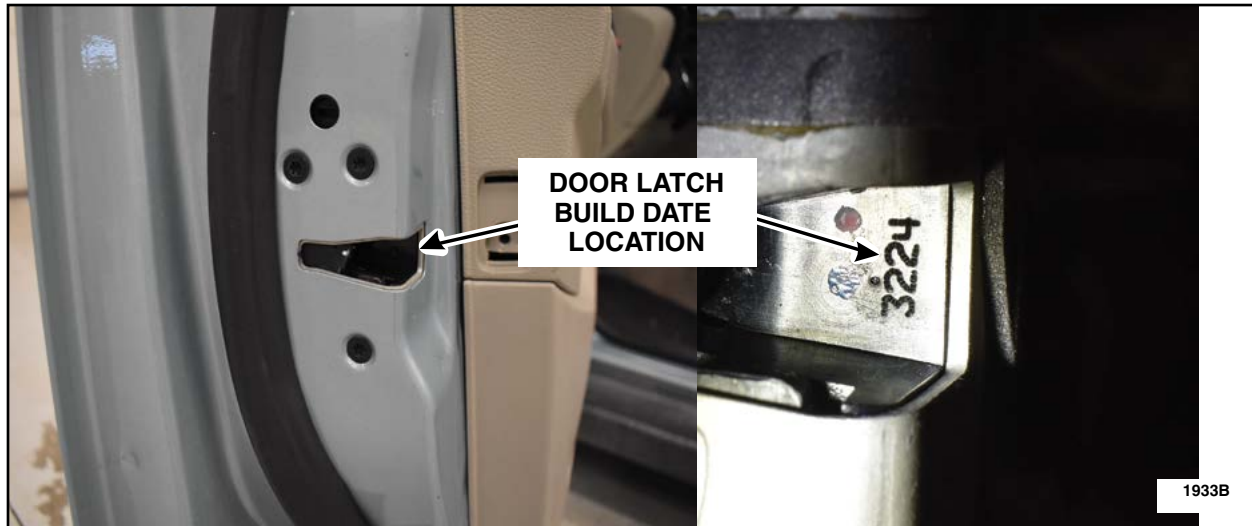

FIGURE 19

6. The service manager must inspect the vehicle to confirm that repairs were completed. Obtain service manager sign-off on the repair order. This will need to be submitted in the SSSC web questionnaire.
7. Update your SSSC approval contact with the photo of the VIN, the new latch date codes, the images of the new latches installed in the vehicle (clearly reflecting the latch date codes), and the Service Manager signoff.



Door Latch Functionality Bench Test

NOTE: Once the door latches have been removed, perform the Door Latch Functionality Bench Test. Record the data for use in the SSSC web questionnaire.

NOTE: Video demonstrating the complete Door Latch Functionality Bench Test can be found below. Rear door latch shown, Front door latch similar.

Bench Test 

1. Using a suitable screwdriver, insert and engage the door latch mechanism. See Figure 20.

NOTE: Rear door latch shown, Front door latch similar.



FIGURE 20

2. Turn the door latch on its side, and slide the interior handle release lever to release the latching mechanism. See Figure 21.



FIGURE 21



3. With the interior handle release lever engaged, place screwdriver back in the latch and verify that the latch releases. See Figure 22.



FIGURE 22

4. Re-engage the latch with the screwdriver. See Figure 20.
5. After the latch has been placed in the latched position, take a second screwdriver and actuate the exterior handle release lever. See Figure 23.

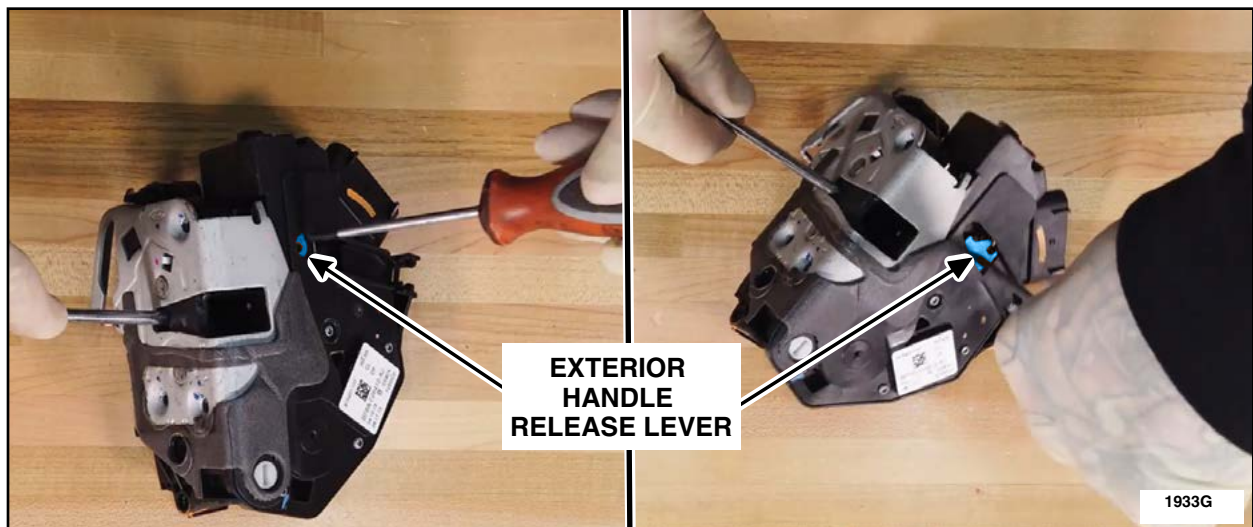

FIGURE 23



6. With the exterior handle release lever engaged, verify that the latch releases. See Figure 24.



FIGURE 24



CERTAIN 2011-2014 FIESTA, 2013-2014 FUSION AND MKZ, 2013-2015 C-MAX AND ESCAPE, 2012-2015 FOCUS, 2015 MKC AND MUSTANG, AND 2014-2016 TRANSIT CONNECT VEHICLES — SIDE DOOR LATCH PREVIOUSLY REPAIRED UNDER 15S16 OR 16S30

SSSC APPROVAL TYPES

Based on the condition of the customer's vehicle and the result of the Dealer Site latch code processing, dealers will need to submit for approval using one of three methods listed in the flow chart below.

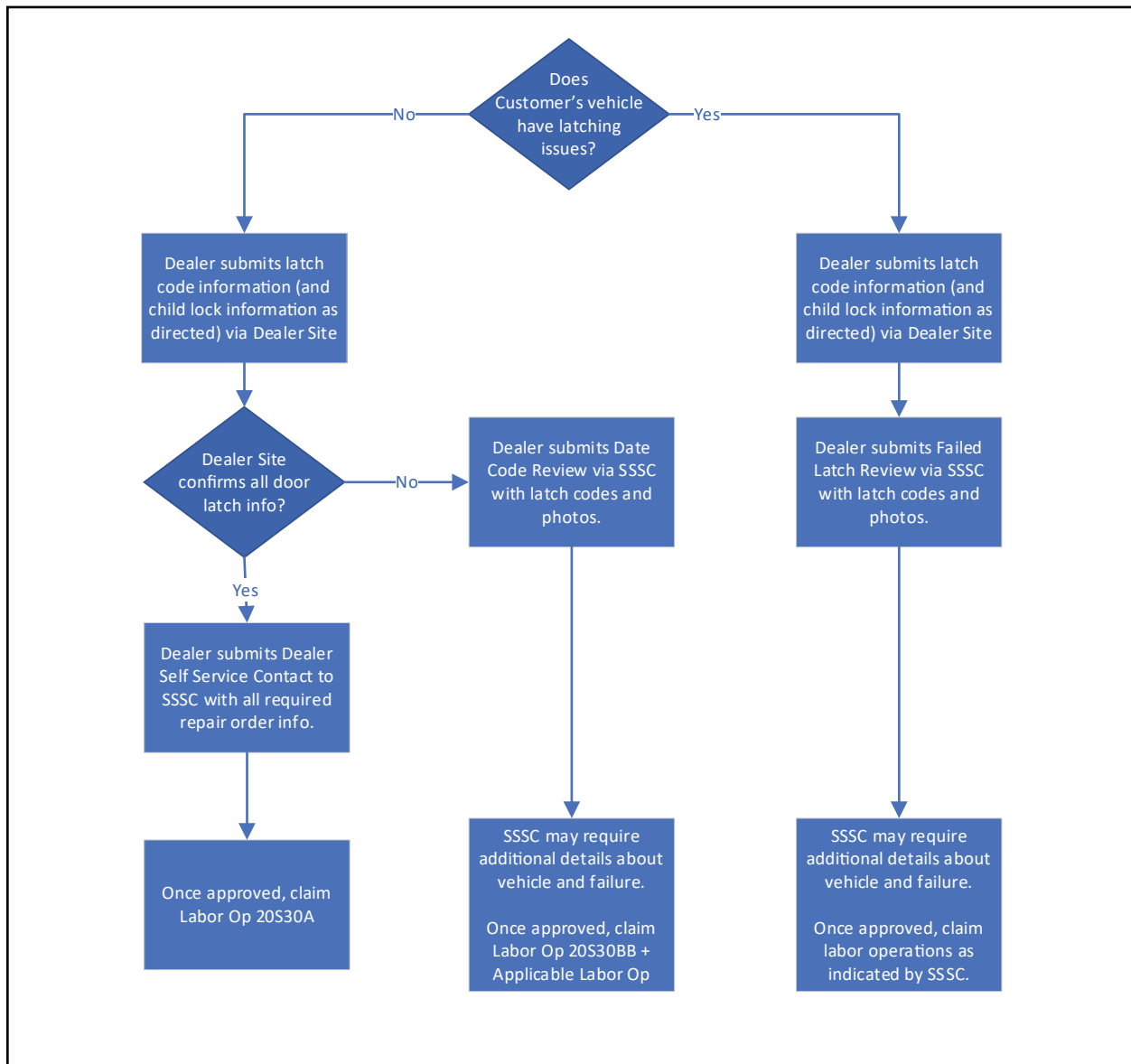

CONTACT PREPARATION

To improve the dealer experience and reduce the potential for unnecessary SSSC contacts, dealers are encouraged to use the following best practices when submitting information to both the Dealer Site and the SSSC. Three contact types are available for processing 20S30 requests.

ALL CONTACTS

- Inspect the latch codes on ALL affected doors – this information will be required on every vehicle that is inspected by a Dealer, whether or not it requires repairs
- Be sure to clearly identify and document each character in each of the latch codes (codes can be 4-7 characters long, including letters and numbers) for accuracy when submitting via the Dealer Site

DEALER SELF SERVICE CONTACTS

- If the Dealer Site indicates that all latches on the vehicle are confirmed, be sure to enter accurate repair order information in the Dealer Self Service contact. Incorrect repair order information will invalidate the approval code and prevent the warranty claim from being processed.

DATE CODE REVIEW & FAILED LATCH REVIEW CONTACTS

- If the Dealer Site indicates a Date Code Review or Failed Latch Review contact is needed:
 - o Ensure that the photos you supply clearly reflect the date codes of ALL affected latches. See Figure 1 for example clear photo. Any of the following can prevent an approval contact from being processed for approval the first time:
 - Latch code out of focus
 - Glare on latch code (use a constant light source and disable the camera's flash for best results)
 - Insufficient lighting
 - Latch code obstructed due to camera angle
 - o Clearly label each door latch using a sticky note (or similar notation). See Figure 1 for an example

NOTE: Photos that do not clearly reflect the location and date code of each affected door latch will prevent an SSSC approval request from being processed.



FIGURE 1

