



March 2020

Dealer Service Instructions for:

Safety Recall W06 / NHTSA 20V-080

Transfer Case

Remedy Available

2019 (DT) Ram 1500 Pickup

NOTE: This recall applies only to the above four-wheel drive vehicles equipped with a 5.7L engine and Electric Shift On Demand Transfer Case (Sales Code DH8)

NOTE: Some vehicles above may have been identified as not involved in this recall and therefore have been excluded from this recall.

IMPORTANT: Some of the involved vehicles may be in dealer used vehicle inventory. Dealers should complete this recall service on these vehicles before retail delivery. Dealers should also perform this recall on vehicles in for service. Involved vehicles can be determined by using the VIP inquiry process.

Subject

The transfer case on about 11 of the above vehicles contains a dual drive gear that may have been installed in an incorrect orientation. A transfer case with a dual drive gear that is misaligned may shift into NEUTRAL when "2WD" is selected, and may remain stuck in NEUTRAL. A transfer case that becomes stuck in NEUTRAL while driving may cause a loss of motive power and will cause a loss of PARK function when stationary. A loss of motive power or a loss of PARK function can cause a vehicle crash without prior warning and/or injury to others outside the vehicle.

Repair

The transfer case must be replaced on all involved vehicles.

Alternate Transportation

Dealers should attempt to minimize customer inconvenience by placing the owner in a loaner vehicle if the vehicle must be held overnight.

Parts Information

Dealers should contact the campaign team at campaignteam@fcagroup.com to obtain the Transfer Case and Bolts for vehicles requiring a replacement part. Please provide the VIN, Mileage, and Dealer Code.

Submit request to campaign team for the Transfer Case and Bolts for each vehicle at the time appointments are scheduled to assure that the parts are available when the customer arrives.

Part Description

Transfer Case, Electronic Shift, BW48-11 Qty. 1

Bolts, Drive Shaft (Locking W/Loctite) Qty. 8

NOTE: Transfer Case comes Pre-Filled with lubricant. Additional lubricant should NOT be necessary.

Parts Return

Return the transfer case to the PDC following the standard core return policy. Dealers will be reimbursed for the core once received by the PDC.

Service Procedure

A. Transfer Case Removal

WARNING: Unintended vehicle movement could lead to personal injury.

1. Chock the wheels to prevent unintended vehicle movement.

NOTE: Ensure the vehicle is in neutral prior to lifting the vehicle to aid in drive shaft removal/installation.

2. Using a trim stick or similar tool, remove the manual park release cover, which is located to the lower left of the steering column (Figure 1).



Figure 1 – Park Release Access Cover

NOTE: When the lever is locked in the released position the access cover cannot be reinstalled.

3. Behind the manual park release access cover is the orange tether strap (Figure 2).



Figure 2 – Park Release Tether

4. Pull the tether strap out as far as it will go, then release it. The tether and lever will remain outside of the trim panel and the transmission will now be in **NEUTRAL** (Figure 3).



Figure 3 – Pull Park Release Tether

Service Procedure

- Open the hood.

NOTE: When disconnecting and isolating the negative battery cable for the 12-volt system, this will also power down the 48-volt battery system. No extra steps will be needed for a power down of the 48-volt system.

- Disconnect the Intelligent Battery Sensor (IBS) wire harness connector (Figure 4).

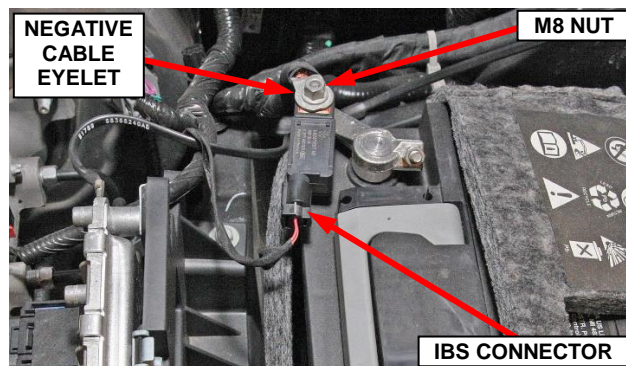

Figure 4 – Battery Negative Post

- Remove and **SAVE** the M8 nut from the IBS (Figure 4).

- Remove the battery negative cable eyelet from the IBS stud and isolate the negative battery cable away from the IBS negative cable terminal (Figure 4).

CAUTION: Failure to isolate the negative battery cable eyelet may cause damage to electrical components.

- Lift and support the vehicle on an appropriate hoist.

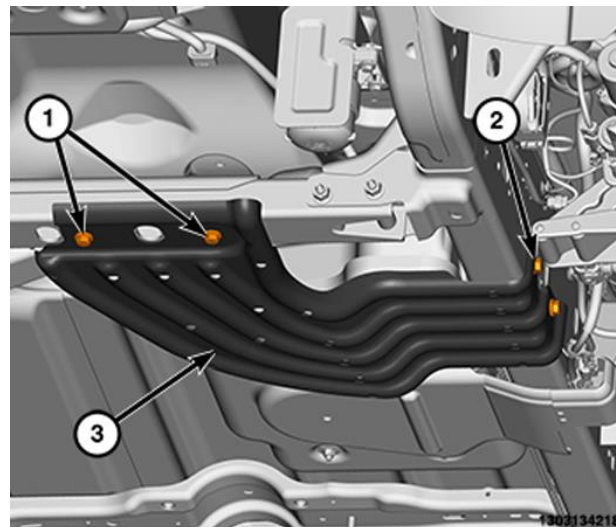

Figure 5 – Transfer Case Skid Plate

- If equipped with a transfer case skid plate. Remove and **SAVE** the bolts (1) and (2) then remove and **SAVE** the skid plate (3) (Figure 5).

Service Procedure [Continued]

11. Place a drain pan under the transfer case then remove and **SAVE** the drain plug. Allow the transfer case to drain while removing drive shafts. Once the transfer case has finished draining, install and tighten the drain plug to 19 N·m (15 ft. lbs.). Transfer case must be drained for core return (Figure 6).

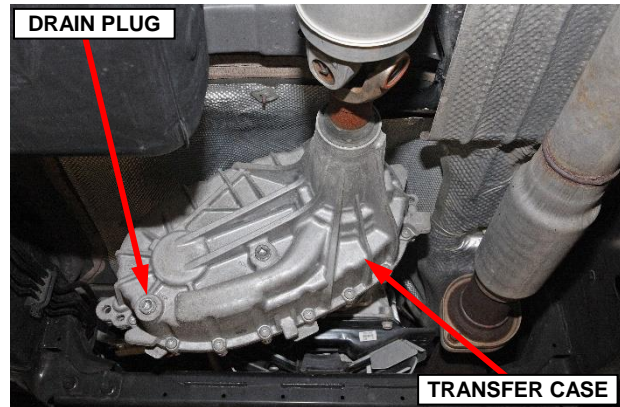

Figure 6 – Transfer Case Drain Plug

12. Mark a line across the front axle companion flange and front drive shaft flange yoke for drive shaft installation reference (Figure 7).

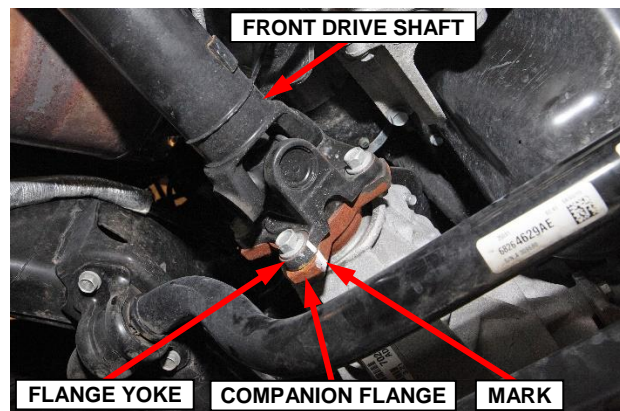

Figure 7 – Mark Front Drive Shaft

13. Mark a line across the rear axle companion flange and rear drive shaft flange yoke for drive shaft installation reference (Figure 8).

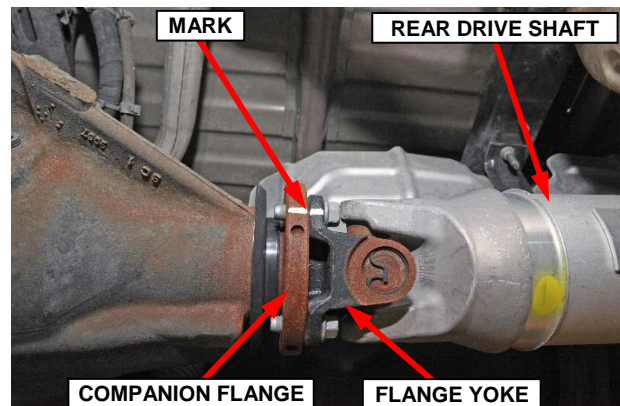

Figure 8 – Mark Rear Drive Shaft

Service Procedure [Continued]

- Remove the four bolts (two per side) securing the front stabilizer bar bushing brackets. Lower the stabilizer bar with bushings and brackets allowing it to be supported by the stabilizer links (Figure 9).

NOTE: The front stabilizer bar must be lowered for front drive shaft removal and installation clearance.

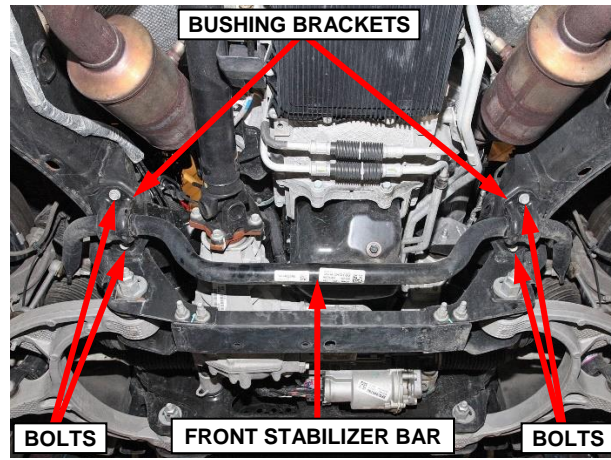

Figure 9 – Front Stabilizer Bar

- Remove and **DISCARD** the four bolts attaching the front drive shaft flange yoke to the front axle companion flange (Figure 10).

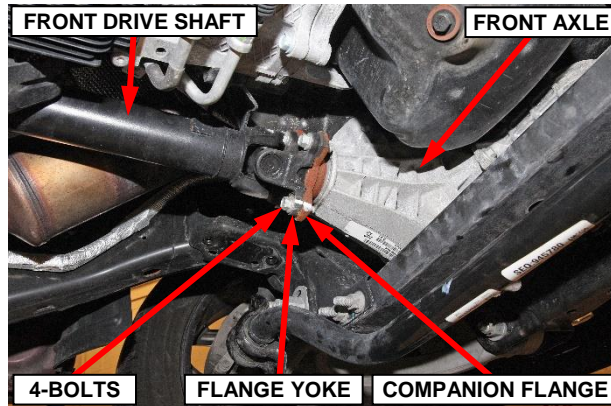

Figure 10 – Front Drive Shaft

- Slide the front drive shaft off the transfer case output shaft spline then remove and **SAVE** the front drive shaft (Figure 11).

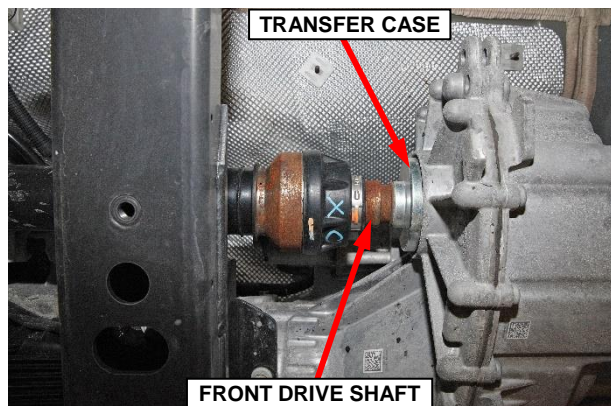

Figure 11 – Front Drive Shaft

Service Procedure [Continued]

17. Remove and **DISCARD** the four bolts attaching the rear drive shaft flange yoke to the rear axle companion flange (Figure 12).

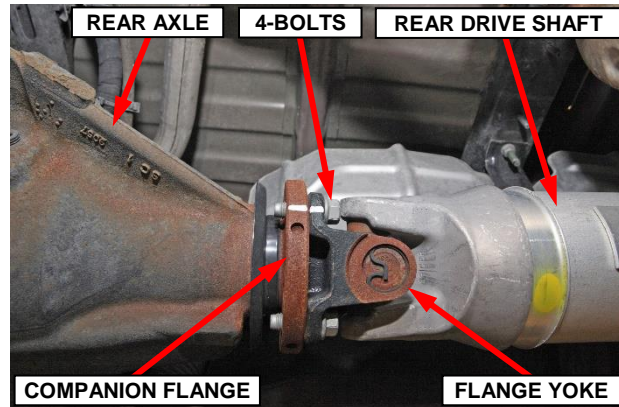

Figure 12 – Rear Drive Shaft

18. Slide the rear drive shaft off the transfer case output shaft spline then remove and **SAVE** the rear drive shaft (Figure 13).

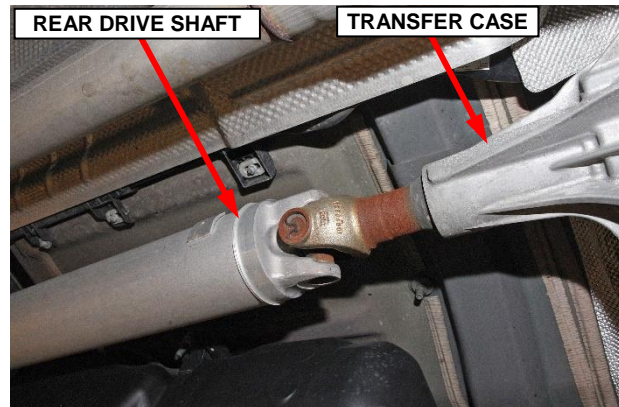

Figure 13 – Rear Drive Shaft

19. Disconnect the wire harness connector from the transfer case shift motor and release the wire harness retainer from the transfer case adapter (Figure 14).

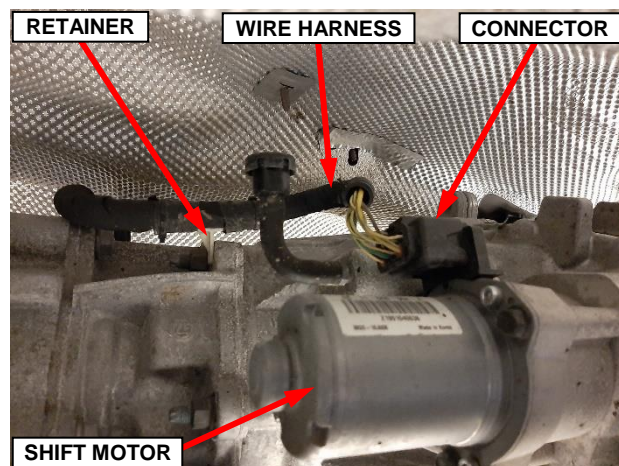

Figure 14 – Transfer Case Shift Motor Wire Harness Connector

Service Procedure [Continued]

20. Disconnect the wire harness connector from the transfer case mode sensor and release the wire harness retainer from the transfer case (Figure 15).

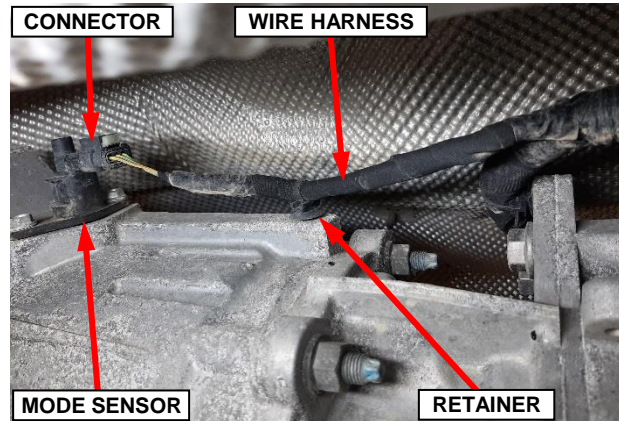

Figure 15 – Transfer Case Shift Mode Sensor Wire Harness Connector

21. Remove and **SAVE** the three nuts securing the transmission mount to the crossmember (Figure 16).

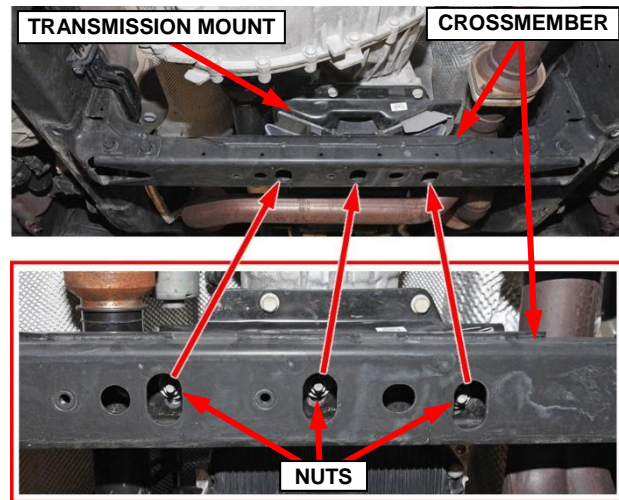

Figure 16 – Transmission Mount Nuts

22. Support the transfer case with a suitable transmission jack or lifting device during crossmember and transmission mount removal (Figure 17).

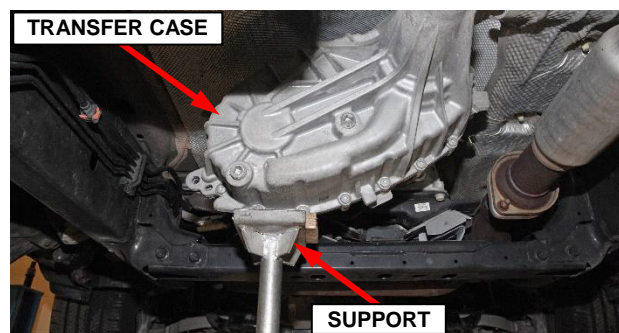

Figure 17 – Support Transfer Case

Service Procedure [Continued]

23. Remove and **SAVE** the four nuts and bolts then remove and **SAVE** the crossmember (Figure 18).

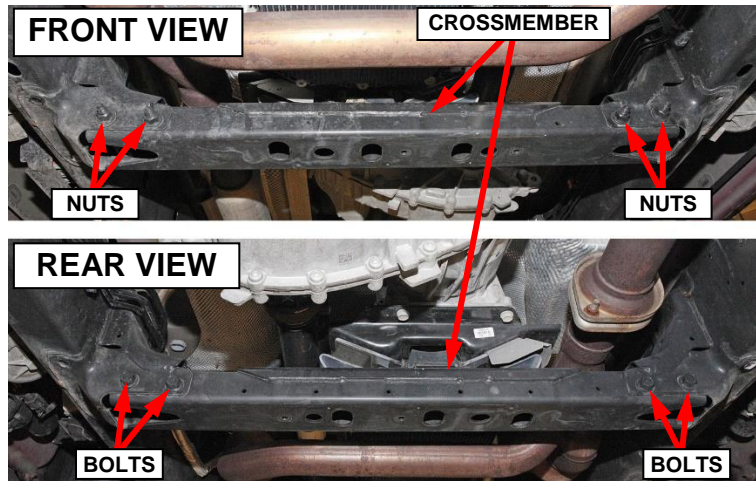

Figure 18 – Transmission Crossmember

24. Remove and **SAVE** the four bolts then remove and **SAVE** the transmission mount (Figure 19).

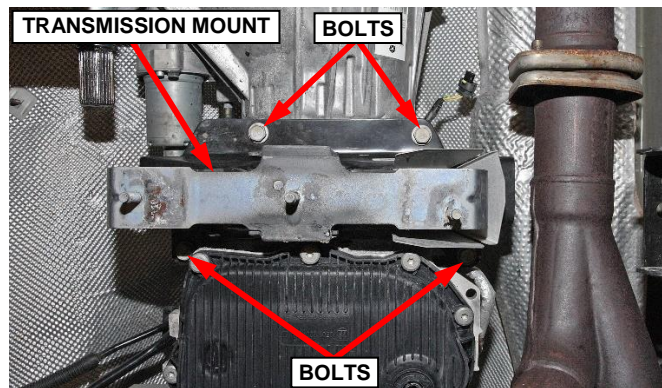

Figure 19 – Transmission Mount

25. Remove and **SAVE** the two bolts then remove and **SAVE** the transmission mount bracket (Figure 20).

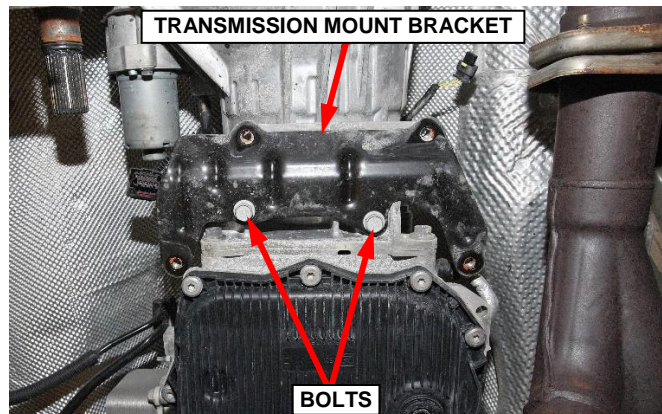

Figure 20 – Transmission Mount Bracket

Service Procedure [Continued]

- 26. Support the transfer case with a suitable transmission jack (Figure 21).
- 27. Secure the transfer case to the jack with chains or straps (Figure 21).
- 28. Remove and **SAVE** the six nuts securing the transfer case to the transmission (Figure 22).

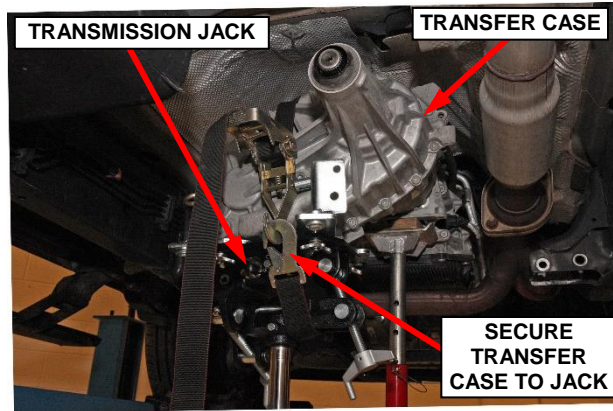

Figure 21 – Support and Secure Transfer Case

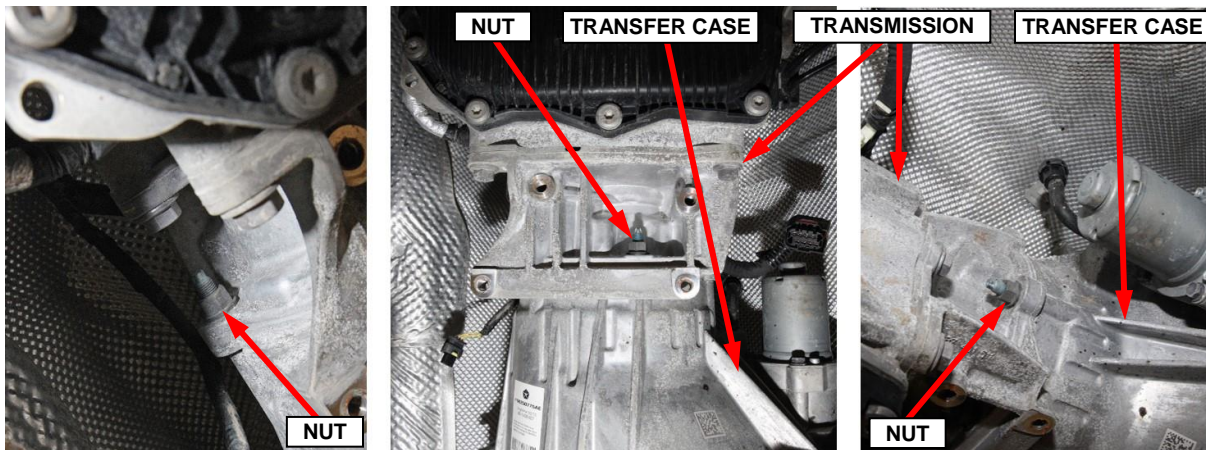

Figure 22 – Transfer Case Fastening – Six Nuts

- 29. Remove the transfer case (1) from the transmission (Figure 23).

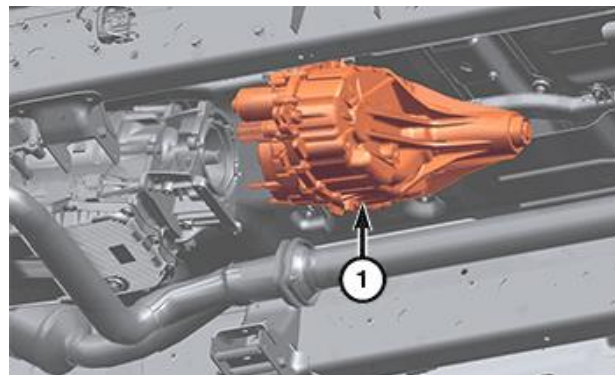

Figure 23 – Transfer Case

Service Procedure [Continued]

30. Remove and **SAVE** the vent hose from the transfer case (Figure 24).
31. Remove the transfer case from the transmission jack.

NOTE: Transfer case must be returned for core deposit.

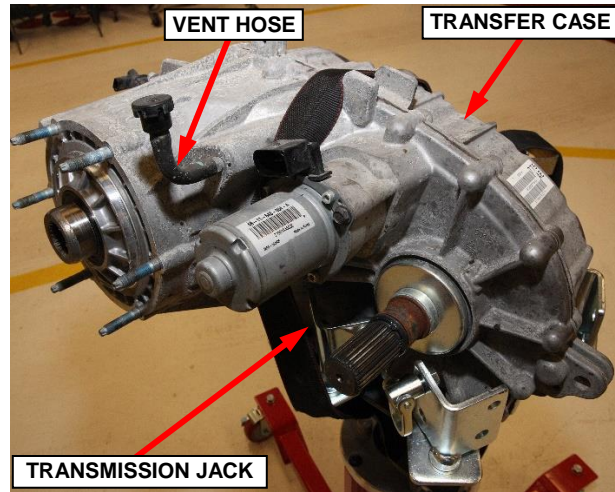

Figure 24 – Transfer Case Vent Hose

B. Transfer Case Installation

1. Uncrate the **NEW** transfer case and save the shipping materials for return of the old transfer case for core deposit (Figure 25).

NOTE: The NEW transfer case comes prefilled with lubricant. Do NOT remove the rear output shipping plug until transfer case is installed in the vehicle and rear drive shaft is ready to be installed. Removal of shipping plug now may result in fluid loss during transfer case installation.



Figure 25 – NEW Transfer Case

2. Secure the **NEW** transfer case onto the transmission jack to prepare for installation (Figure 24).
3. Install the vent hose onto the **NEW** transfer case (Figure 24).

Service Procedure [Continued]

4. Install the **NEW** transfer case (1) to the transmission (Figure 23).
5. Install the six nuts securing the transfer case to the transmission. Tighten the nuts to 41 N·m (30 ft. lbs.) (Figure 22).
6. Install the transmission mount bracket and the two bolts then tighten the bolts to 64 N·m (47 ft. lbs.) (Figure 20).
7. Install the transmission mount and the four bolts then tighten the bolts to 64 N·m (47 ft. lbs.) (Figure 19).
8. Install the transmission crossmember and the four bolts and nuts (Figure 18). Tighten the bolts to 115 N·m (85 ft. lbs.).
9. Lower the transfer case until fully supported by the transmission crossmember then remove the transmission jack or lifting device (Figure 17).
10. Install the three nuts securing the transmission mount to the crossmember (Figure 16). Tighten the nuts to 25 N·m (18 ft. lbs.).
11. Connect the wire harness connector to the transfer case mode sensor and attach the wire harness retainer to the transfer case (Figure 15).
12. Connect the wire harness connector to the transfer case shift motor and attach the wire harness retainer to the transfer case adapter (Figure 14).

Service Procedure [Continued]

13. Remove the shipping plug from the rear output of the transfer case. Transfer the shipping plug to the old transfer case for core return (Figure 26).

14. Slide the rear drive shaft onto the transfer case output shaft spline (Figure 13).

15. Use the mark made earlier to align the rear drive shaft flange yoke to the rear axle companion flange (Figure 12).

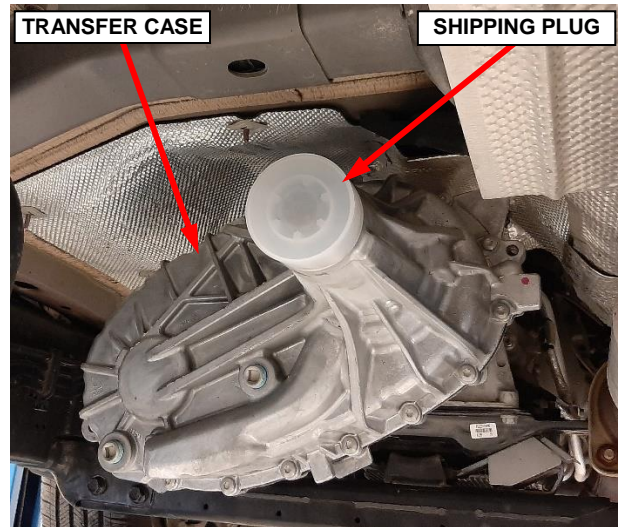

Figure 26 – Remove Shipping Plug

16. Install the four **NEW** bolts attaching the rear drive shaft flange yoke to the rear axle companion flange (Figure 12). Tighten the bolts to 115 N·m (85 ft. lbs.).

17. Slide the front drive shaft onto the transfer case output shaft spline (Figure 11).

18. Use the mark made earlier to align the front drive shaft flange yoke to the front axle companion flange (Figure 10).

19. Install the four **NEW** bolts attaching the front drive shaft flange yoke to the front axle companion flange (Figure 10). Tighten the bolts to 115 N·m (85 ft. lbs.).

20. Raise the stabilizer bar into position then install the four bolts (two per side) securing the front stabilizer bar bushing brackets (Figure 9). Tighten the bolts to 45 N·m (33 ft. lbs.).

Service Procedure [Continued]

NOTE: The NEW transfer case comes filled with lubricant however lubricant level should be checked before releasing vehicle.

21. Position a drain pan under the transfer case to catch any lubricant.

22. Remove the transfer case fill plug. Transfer case should be filled to the bottom edge of the fill plug opening (Figure 27).

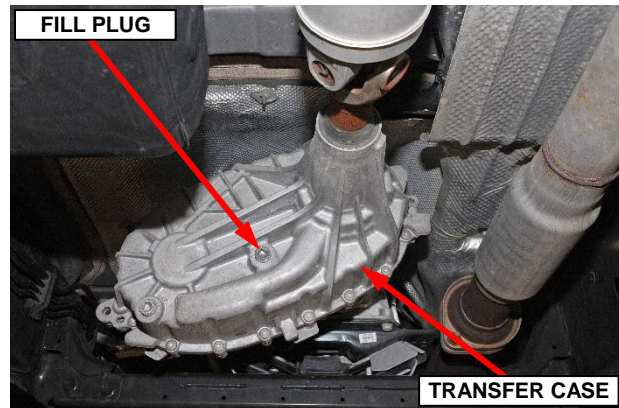

Figure 27 – Transfer Case Fill Plug

23. If necessary, fill the transfer case to the bottom edge of the fill plug opening with T-Case BorgWarner lubricant, MOPAR part number 68049954AC (Figure 27).

24. Install the transfer case fill plug and tighten to 19 N·m (15 ft. lbs.) (Figure 27).

25. Wipe any excess fluid that may have spilled.

26. **If equipped with a transfer case skid plate.** Install the skid plate (3) then install the bolts (1) and (2) (Figure 5). Tighten the bolts to 55 N·m (41 ft. lbs.).

27. Lower the vehicle.

28. Install the negative battery cable eyelet to the IBS M8 stud and secure using the M8 nut (Figure 4). Tighten the M8 nut to 7 N·m (62 in. lbs.).

NOTE: Overtightening of the M8 nut for the negative cable to the IBS will cause damage to the IBS or break the stud for the nut.

29. Connect the IBS wire harness connector (Figure 4).

Service Procedure [Continued]

30. Apply firm pressure to the brake pedal while seated in the driver's seat.
31. Pull the tether strap outward then release it (Figure 3).
32. Allow the tether to retract with the lever back to its original position. Confirm that the lever is fully retracted.
33. Stow the tether strap behind the retaining clip (Figure 2).
34. Verify the transmission is in PARK.
35. Install the manual park release access cover (Figure 1).
36. To complete the relearn process and verify the transfer case shift operation. Start the engine. Shift the transmission into NEUTRAL then shift the transfer case into 4WD LOW mode. Shift the transmission into DRIVE to confirm the transfer case has fully completed the shift into 4WD LOW mode. Then repeat the shift process to return the transfer case to 2WD mode. Turn the engine off.
37. Using wiTECH, clear all Diagnostic Trouble Codes (DTCs).
38. To enhance customer satisfaction, remember to reset the clock.
39. Return the vehicle to the customer or vehicle inventory.

Completion Reporting and Reimbursement

Claims for vehicles that have been serviced must be submitted on the DealerCONNECT Claim Entry Screen located on the Service tab. Claims paid will be used by FCA to record recall service completions and provide dealer payments.

Use the following labor operation numbers and time allowances:

	Labor Operation Number	Time Allowance
Replace Transfer Case Assembly	21-W0-61-82	2.0 hours

Optional Equipment:

Transfer Case Skid Plate	21-W0-61-60	0.2 hours
--------------------------	-------------	-----------

Add the cost of the recall parts plus applicable dealer allowance to your claim.

NOTE: See the Warranty Administration Manual, Recall Claim Processing Section, for complete recall claim processing instructions.

Dealer Notification

To view this notification on DealerCONNECT, select “Global Recall System” on the Service tab, then click on the description of this notification.

Owner Notification and Service Scheduling

All involved vehicle owners known to FCA are being notified of the service requirement by first class mail. They are requested to schedule appointments for this service with their dealers. A generic copy of the owner letter is attached.

Vehicle Lists, Global Recall System, VIP and Dealer Follow Up

All involved vehicles have been entered into the DealerCONNECT Global Recall System (GRS) and Vehicle Information Plus (VIP) for dealer inquiry as needed.

GRS provides involved dealers with an updated VIN list of their incomplete vehicles. The owner's name, address and phone number are listed if known. Completed vehicles are removed from GRS within several days of repair claim submission.

To use this system, click on the “**Service**” tab and then click on “**Global Recall System.**” Your dealer's VIN list for each recall displayed can be sorted by: those vehicles that were unsold at recall launch, those with a phone number, city, zip code, or VIN sequence.

Dealers must perform this repair on all unsold vehicles before retail delivery. Dealers should also use the VIN list to follow up with all owners to schedule appointments for this repair.

Recall VIN lists may contain confidential, restricted owner name and address information that was obtained from the Department of Motor Vehicles of various states. Use of this information is permitted for this recall only and is strictly prohibited from all other use.

Additional Information

If you have any questions or need assistance in completing this action, please contact your Service and Parts District Manager.

Customer Services / Field Operations
FCA US LLC

This notice applies to your vehicle,

[Model Year and Model]

VIN XXXXXXXXXXXXXXXXXXXX

W06/NHTSA 20V-080

LOGO

VEHICLE PICTURE

YOUR SCHEDULING OPTIONS

- 1. RECOMMENDED OPTION**
Call your authorized Chrysler / Dodge / Jeep® / RAM] / Dealership
- 2. Call the FCA Recall Assistance Center at 1-800-853-1403. An agent can confirm part availability and help schedule an appointment**
- 3. Visit recalls.mopar.com, scan the QR code below, or download the Mopar Owner's Companion App.**

QR Code

Get access to recall notifications, locate your nearest dealer, and more through this website or Mopar Owner's Companion App. You will be asked to provide your Vehicle Identification Number (VIN) to protect and verify your identity. The last eight characters of your VIN are provided above.

DEALERSHIP INSTRUCTIONS

Please reference Safety Recall W06.

IMPORTANT SAFETY RECALL

Transfer Case

Dear [Name],

This notice is sent to you in accordance with the National Traffic and Motor Vehicle Safety Act.

FCA US has decided that a defect, which relates to motor vehicle safety, exists in certain four-wheel drive [2019 Model Year (DT) Ram Pickup] vehicles equipped with a 5.7L engine and Electric Shift On Demand Transfer Case.

It is extremely important to take steps now to repair your vehicle to ensure the safety of you and your passengers.

WHY DOES MY VEHICLE NEED REPAIRS?

The transfer case on your vehicle ^[1] contains a dual drive gear that may have been installed in an incorrect orientation. A transfer case with a dual drive gear that is misaligned may shift into NEUTRAL when "2WD" is selected, and may remain stuck in NEUTRAL. A transfer case that becomes stuck in NEUTRAL while driving may cause a loss of motive power and will cause a loss of PARK function when stationary. **A loss of motive power or a loss of PARK function can cause a vehicle crash without prior warning and/or injury to others outside the vehicle.**

HOW DO I RESOLVE THIS IMPORTANT SAFETY ISSUE?

FCA US will repair your vehicle ^[2] free of charge (parts and labor). To do this, your dealer will replace the transfer case. The estimated repair time is two hours. In addition, your dealer will require your vehicle for proper check-in, preparation, and check-out during your visit, which may require more time. Your time is important to us, so we recommend that you schedule a service appointment to minimize your inconvenience. Please bring this letter with you to your dealership.

**TO SCHEDULE YOUR FREE REPAIR,
CALL YOUR CHRYSLER, DODGE, JEEP OR RAM DEALER TODAY**

WHAT IF I ALREADY PAID TO HAVE THIS REPAIR COMPLETED?

If you have already experienced this specific condition and have paid to have it repaired, you may visit www.fcarecallreimbursement.com to submit your reimbursement request online. ^[3] Once we receive and verify the required documents, reimbursement will be sent to you within 60 days. If you have had previous repairs performed and/or already received reimbursement, you may still need to have the recall repair performed.

We apologize for any inconvenience, but are sincerely concerned about your safety. Thank you for your attention to this important matter.

Customer Assistance/Field Operations
FCA US LLC



Mr. Mrs. Customer
1234 Main Street
Hometown, MI 48371

[1] If you no longer own this vehicle, please help us update our records. Call the FCA Recall Assistance Center at 1-800-853-1403 to update your information.

[2] If your dealer fails or is unable to remedy this defect without charge and within a reasonable time, you may submit a written complaint to the Administrator, National Highway Traffic Safety Administration, 1200 New Jersey Ave., S.E., Washington, DC 20590, or you can call the toll-free Vehicle Safety Hotline at 1-888-327-4236 (TTY 1-800-424-9153), or go to safercar.gov.

[3] You can also mail in your original receipts and proof of payment to the following address for reimbursement consideration: FCA Customer Assistance, P.O. Box 21-8004, Auburn Hills, MI 48321-8007, Attention: Recall Reimbursement.

Note to lessors receiving this recall notice: Federal regulation requires that you forward this recall notice to the lessee within 10 days.

This notice applies to your vehicle,

[Model Year and Model]

VIN XXXXXXXXXXXXXXXXXXXX

W06/NHTSA 20V-080

LOGO

VEHICLE PICTURE

FOR RECALL QUESTIONS

1. RECOMMENDED OPTION

Call your authorized Chrysler / Dodge / Jeep® / RAM / Dealership

2. Call the FCA Recall Assistance Center at 1-800-853-1403.

An agent can confirm if there are any recall repairs which must be performed on your vehicle

3. Visit recalls.mopar.com, scan the QR code below, or download the Mopar Owner's Companion App.

QR Code

Get access to recall notifications, locate your nearest dealer, and more through this website or Mopar Owner's Companion App. You will be asked to provide your Vehicle Identification Number (VIN) to protect and verify your identity. The last eight characters of your VIN are provided above.

DEALERSHIP INSTRUCTIONS

Please reference Safety Recall W06.

IMPORTANT SAFETY RECALL

Transfer Case

Dear [Name],

This notice is sent to you in accordance with the National Traffic and Motor Vehicle Safety Act.

FCA US has decided that a defect, which relates to motor vehicle safety, exists in certain four-wheel drive [2019 Model Year (DT) Ram Pickup] vehicles equipped with a 5.7L engine and Electric Shift On Demand Transfer Case.

RECALL DESCRIPTION

The transfer case on your vehicle ^[1] contains a dual drive gear that may have been installed in an incorrect orientation. A transfer case with a dual drive gear that is misaligned may shift into NEUTRAL when "2WD" is selected, and may remain stuck in NEUTRAL. A transfer case that becomes stuck in NEUTRAL while driving may cause a loss of motive power and will cause a loss of PARK function when stationary. **A loss of motive power or a loss of PARK function can cause a vehicle crash without prior warning and/or injury to others outside the vehicle.**

YOUR VEHICLE HAS ALREADY BEEN REMEDIED

According to our service records, the transfer case has already been replaced on your vehicle. Therefore, your vehicle has been remedied and this safety recall does not need to be performed.

This notification is provided for your records only. There is nothing more that you need to do.

WHAT IF I HAVE QUESTIONS REGARDING THIS RECALL?

If you believe the transfer case in your vehicle ^[2] has not been replaced or have questions or concerns which your dealer is unable to resolve, please contact the FCA Group Recall Assistance Center at either fcarecalls.com or 1 800-853-1403.

WHAT IF I ALREADY PAID TO HAVE THIS REPAIR COMPLETED?

If you have already experienced this specific condition and have paid to have it repaired, you may visit www.fcarecallreimbursement.com to submit your reimbursement request online. ^[3] Once we receive and verify the required documents, reimbursement will be sent to you within 60 days. If you have had previous repairs performed and/or already received reimbursement, you may still need to have the recall repair performed.

We apologize for any inconvenience, but are sincerely concerned about your safety. Thank you for your attention to this important matter.

Customer Assistance/Field Operations
FCA US LLC



Mr. Mrs. Customer
1234 Main Street
Hometown, MI 48371

[1] If you no longer own this vehicle, please help us update our records. Call the FCA Recall Assistance Center at 1-800-853-1403 to update your information.

[2] If your dealer fails or is unable to remedy this defect without charge and within a reasonable time, you may submit a written complaint to the Administrator, National Highway Traffic Safety Administration, 1200 New Jersey Ave., S.E., Washington, DC 20590, or you can call the toll-free Vehicle Safety Hotline at 1-888-327-4236 (TTY 1-800-424-9153), or go to safercar.gov.

[3] You can also mail in your original receipts and proof of payment to the following address for reimbursement consideration: FCA Customer Assistance, P.O. Box 21-8004, Auburn Hills, MI 48321-8007, Attention: Recall Reimbursement.

Note to lessors receiving this recall notice: Federal regulation requires that you forward this recall notice to the lessee within 10 days.