

2018-20 Odyssey Floor Harness Removal and Installation

Supersedes job aid 2018-20 Odyssey Floor Harness Removal and Installation, dated February 2020, to revise the information highlighted in **yellow**

AFFECTED VEHICLES

Year	Model	Trim
2018-20	Odyssey	EX-L, EX-L with Navigation and RES, Touring, and Elite

REVISION SUMMARY

PARTS INFORMATION section was temporarily removed due to parts supply. When parts are available the section will return.

BACKGROUND

Use the procedures listed in this job aid to remove and install the floor harness.

REPAIR INFORMATION

NOTE

The following procedures are laid out to do the replacement on a twin-post lift. Steps 1 thru 3 can be done after positioning the vehicle on an in-ground lift.

Interior Area			
	Component / Action	Applicable Service Information	Notes
1	2nd Row Seats Remove.		
2	Dashboard Side Cover Remove.	Dashboard Side Cover Removal and Installation	Driver's side only

Interior Area

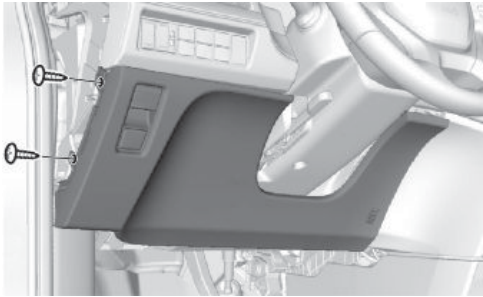
	Component / Action	Applicable Service Information	Notes
3	Driver's Dashboard Lower Cover	Driver's Dashboard Lower Cover Removal and Installation	<ul style="list-style-type: none"> Remove the two screws only. Do not remove the cover. 
4	Position the Vehicle on the Lift		Do not raise the vehicle.
5	Rear Trim Panel Remove.	Interior Trim Removal and Installation - Cargo Areas	
6	3rd Row Seats Stow away.		
7	Sliding Door Sill Lower Trim Remove.	Interior Trim Removal and Installation - Door Areas	Do only steps 1 and 2 of the sliding door sill area.
8	Second Row Seat Trims/Covers Remove.	Second Row Seat Slide Rail Removal and Installation	Do only step 4 of the second row seat slide rail.
9	Fuel Pressure Relieve.	Fuel Pressure Relieving	Do steps 1-2 and 5-6.
10	Fuel Line Quick-Connect Fitting Disconnect.	Fuel Line/Quick-Connect Fitting Precautions	Disconnect the quick-connect fitting at the fuel tank unit.
11	Front Seats Remove.	Front Seat Removal and Installation	Both left and right
12	Center Console Remove.	Center Console Removal and Installation	
13	RES Screen Remove.	Rear Entertainment System (RES) Screen Removal and Installation	Models with RES only
14	Headliner Remove.	Headliner Removal and Installation	Lift the vehicle as necessary to remove the right-front inner fender as necessary in step 6.

Second Row Seat Slide Rail Area

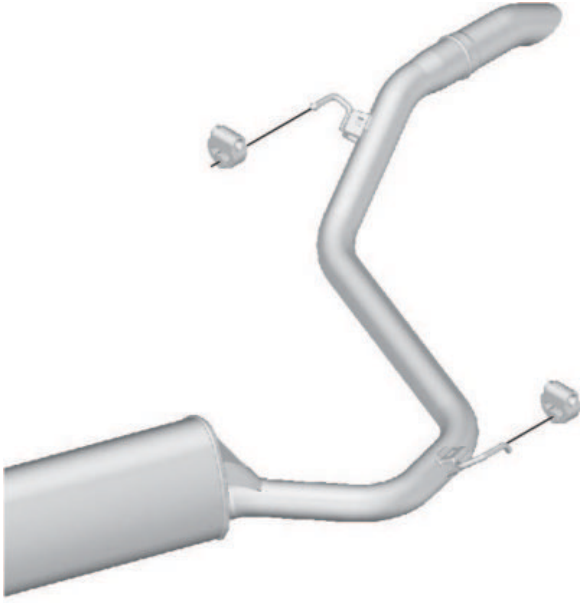
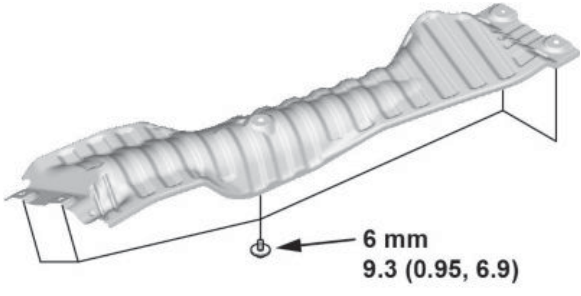
	Component / Action	Applicable Service Information	Notes
1	<p>Exhaust Pipe Disconnect.</p>	<p>Exhaust Pipe and Muffler Removal and Installation</p>	<p>Only disconnect the two exhaust hangers as shown.</p> 
2	<p>Heat Shield Remove.</p>		<p>Remove the rear shield.</p> 
3	<p>Fuel Tank Lower.</p>	<p>Fuel Tank Removal and Installation</p>	<ul style="list-style-type: none"> • Start from step 3. • Secure the tank with a lift table.

Second Row Seat Slide Rail Area

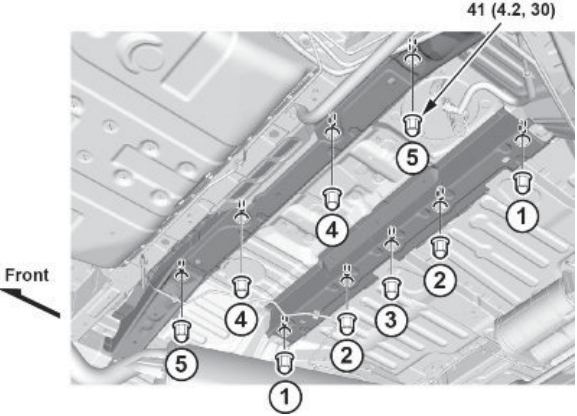
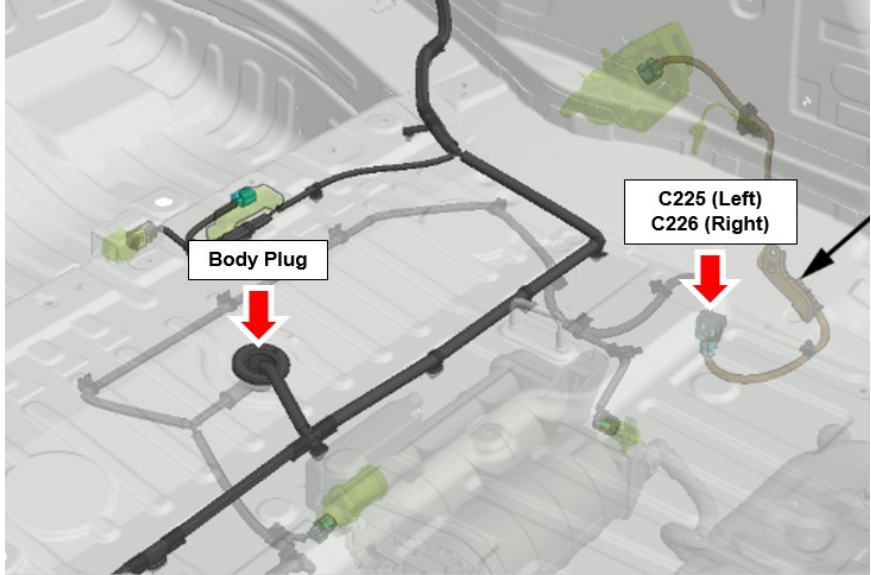
	Component / Action	Applicable Service Information	Notes
4	<p>Second Row Seat Slide Rail Removal (lower bolts)</p>	<p>Second Row Seat Slide Rail Removal and Installation</p>	<p>Lower the fuel tank as necessary, and remove the nuts (nine total) in step 10.</p> <p>NOTE The nuts have a tightening sequence during installation.</p> 
5	<p>EVAP Canister Remove.</p>	<p>EVAP System Removal and Installation</p>	
6	<p>Disconnect Harness (under-floor portion)</p>	<p>Disconnect all of the under-floor portion of the harness from the body plug to the inline connectors C225 (left-side) and C226 (right-side)</p> <p>NOTE Allow the harness to hang, and keep it from getting caught onto components. This branch of the harness will be removed through the harness body plug later in this procedure.</p> <p>The below image is a top view. The under-floor portion is under the vehicle.</p> 	

Second Row Seat Slide Rail Area			
	Component / Action	Applicable Service Information	Notes
7	Fuel Tank Raise.	Fuel Tank Removal and Installation	Raise and secure the tank temporarily by installing the fuel tank straps. Refer to step 12 of the service information procedure.

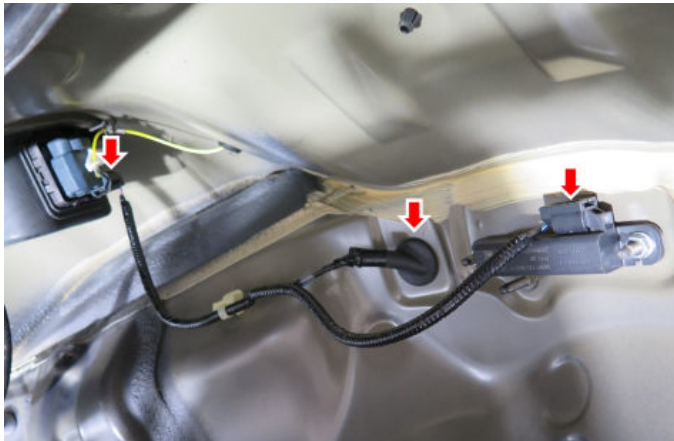
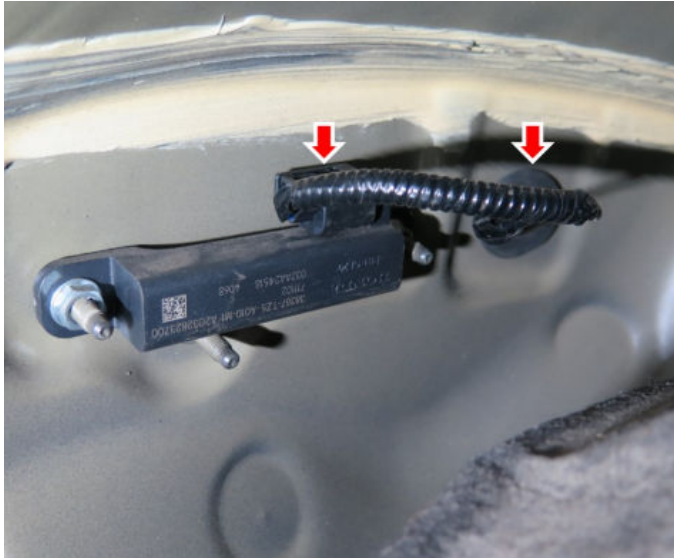
Second Row Seat Slide Rail Area		
	Component / Action	Notes
8	Keyless Access LF Antenna / Fuel Fill Door Lock Actuator Disconnect.	<p>Left Side</p> <ol style="list-style-type: none"> 1. Disconnect the left-rear keyless access LF antenna and the fuel fill door lock actuator connectors. 2. Push the harness body plug and connectors through the hole into the interior.  <p>Right Side</p> <p>NOTE Remove the right-rear inner fender as necessary to do the following:</p> <ol style="list-style-type: none"> 1. Disconnect the right-rear keyless access LF antenna connector. 2. Push the harness body plug and connector through the hole into the interior. 

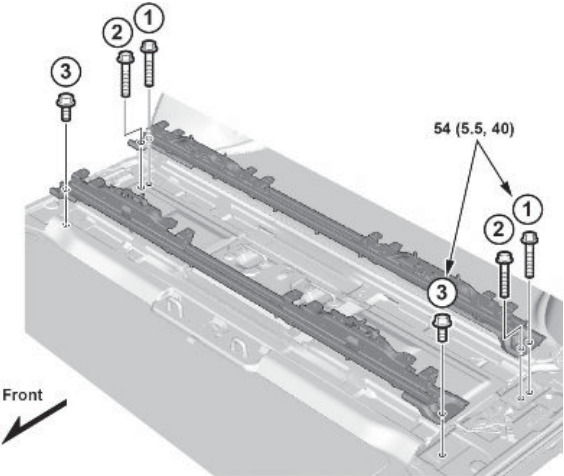

Second Row Seat Slide Rail Area			
	Component / Action	Applicable Service Information	Notes
9	Second Row Seat Slide Rail Removal Remove.	Second Row Seat Slide Rail Removal and Installation	<p>Lower the vehicle and remove the bolts. With the help of an assistant. Remove the rail assembly.</p> 

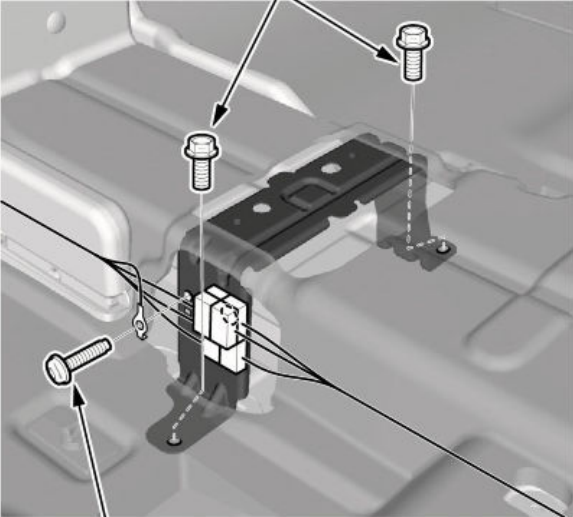
Floor Area			
	Component / Action	Applicable Service Information	Notes
1	Driver's Dashboard Lower Cover Remove.	Driver's Dashboard Lower Cover Removal and Installation	Do step 2.
2	Middle Interior LF Antenna Remove.	Keyless Access LF Antenna Removal and Installation	
3	Front Floor Carpet Remove.	Carpet Removal and Installation	Do steps 3, 5, 7, and 8.
4	Middle Floor Carpet Remove.		<ul style="list-style-type: none"> Do steps 8 and 9. Place a blanket over the spare tire lid or remove it to prevent foot prints or damage.

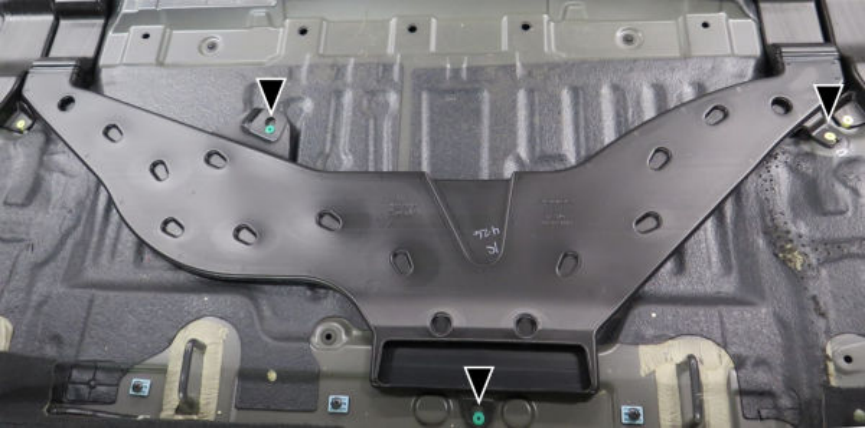
Floor Area			
	Component / Action	Applicable Service Information	Notes
5	Center Console Bracket Remove.	Center Console Removal and Installation	Refer to step 4.  22 Nm (16 lb.ft) 11 Nm (8 lb.ft) Replace.

Floor Area			
	Component / Action	Notes	
6	Rear Floor Heat Duct Remove.	<ul style="list-style-type: none"> • Three clips. 	

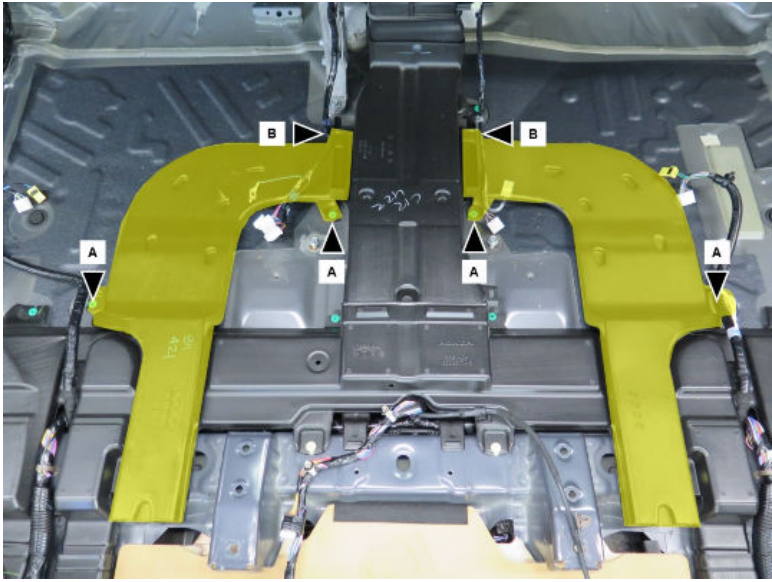

Floor Area

	Component / Action	Notes
7	Heater Ducts Remove.	<ul style="list-style-type: none">Remove the left and right side.Two clips (A), One harness clip (B) per side. 
8	A/C Floor Ducts Remove.	<ul style="list-style-type: none">Remove the left and right side.Two clips (A) per side. 

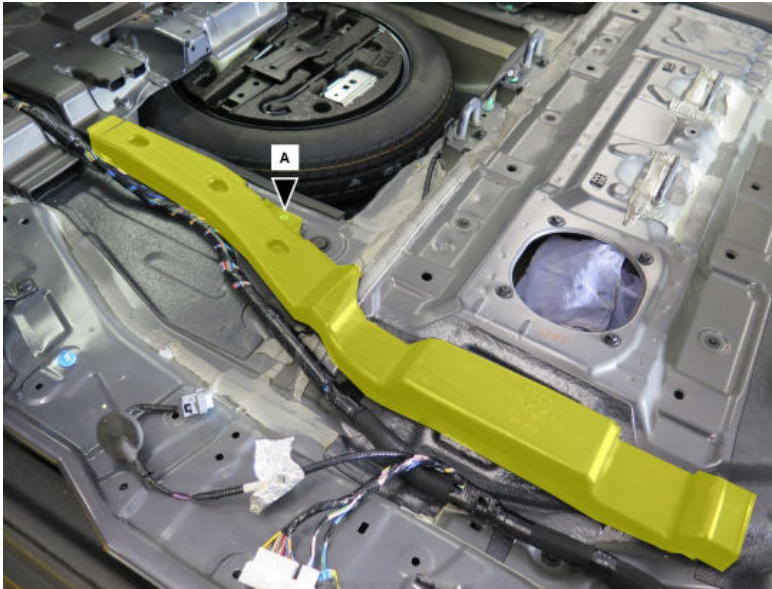
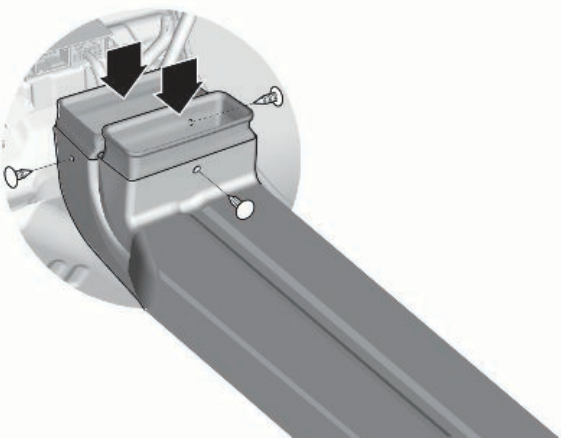
Floor Area

	Component / Action	Notes
9	Heat Floor Ducts Remove.	<ul style="list-style-type: none">Remove the left and right side.One clip (A) per side. 
10	Front Heater Slide Joint Disconnect.	<ul style="list-style-type: none">Three clips. 

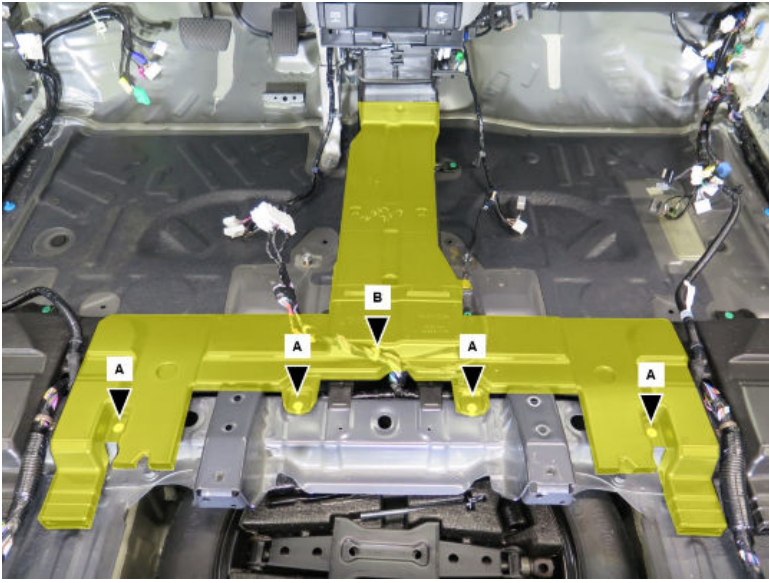
Floor Area

	Component / Action	Notes
11	Floor Heat Joint Duct Remove.	<ul style="list-style-type: none">Four clips (A), One harness clip (B). 
12	B-Pillar Ducts Remove.	<ul style="list-style-type: none">Remove the left and right side.Two clips. 

Floor Area

Component / Action

Notes

13

Floor Joint Duct
Remove.

- Seven clips.

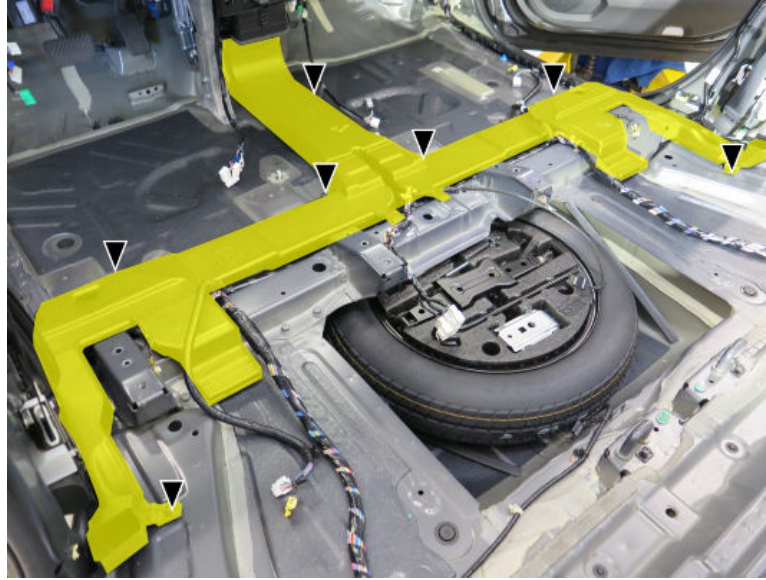

Floor Area

Component / Action

Notes

14

Side Curtain Airbag Bolts

Remove.

Right - Remove the two bolts above the C-pillar.



Left - Remove the three bolts above the C-pillar.

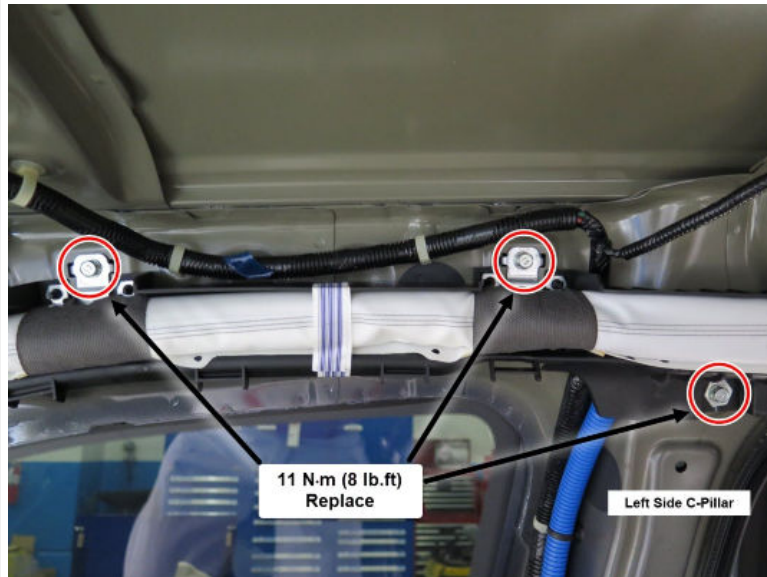

NOTE

This will allow room for the harness to pass through during removal.

Floor Area

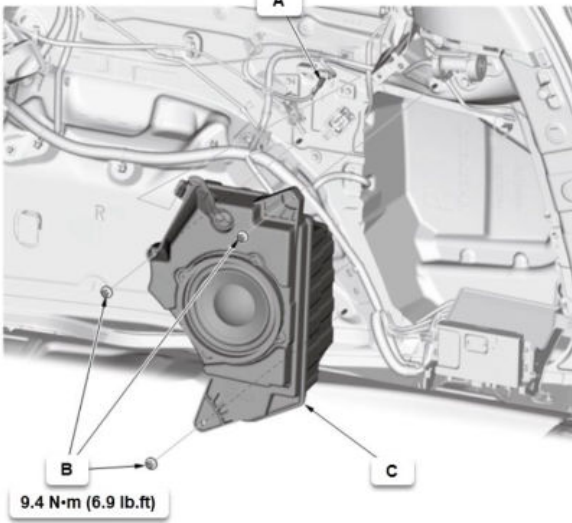
	Component / Action	Notes
15	Subwoofer Remove.	<ol style="list-style-type: none">1. Disconnect the connector (A).2. Remove the nuts (B).  <p>The diagram shows a subwoofer mounted in a car's floor area. A connector labeled 'A' is shown being disconnected from the subwoofer. Two nuts labeled 'B' are shown being removed from the subwoofer's mounting points. A torque specification of 9.4 N·m (6.9 lb.ft) is indicated for the nuts. A label 'C' points to the subwoofer's mounting bracket. The car's interior floor and wiring are also visible.</p>

Floor Area

Component / Action

Notes

16

Third Row Seat
Upper and Lower
Pivot Cover

Remove.

Remove the lower cover, then the upper cover.

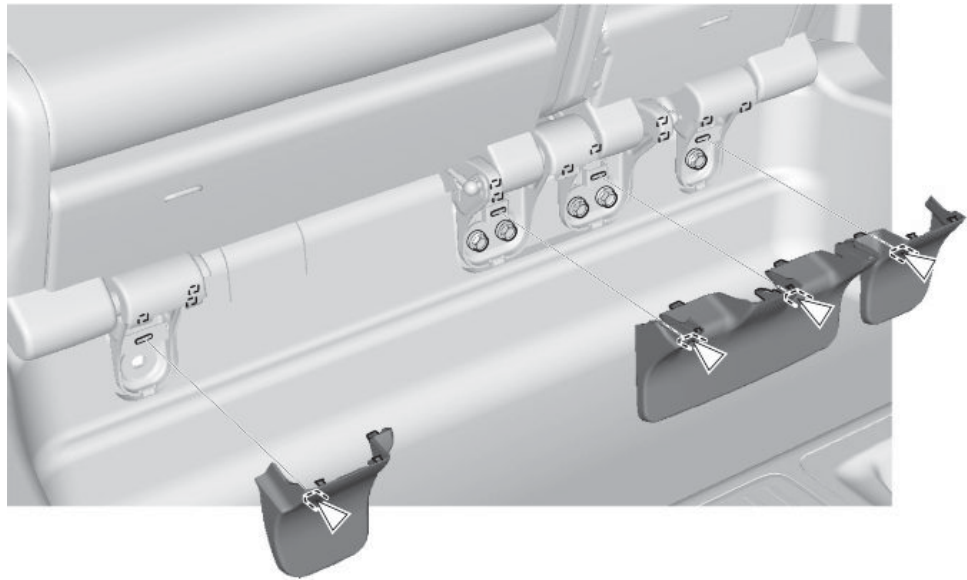
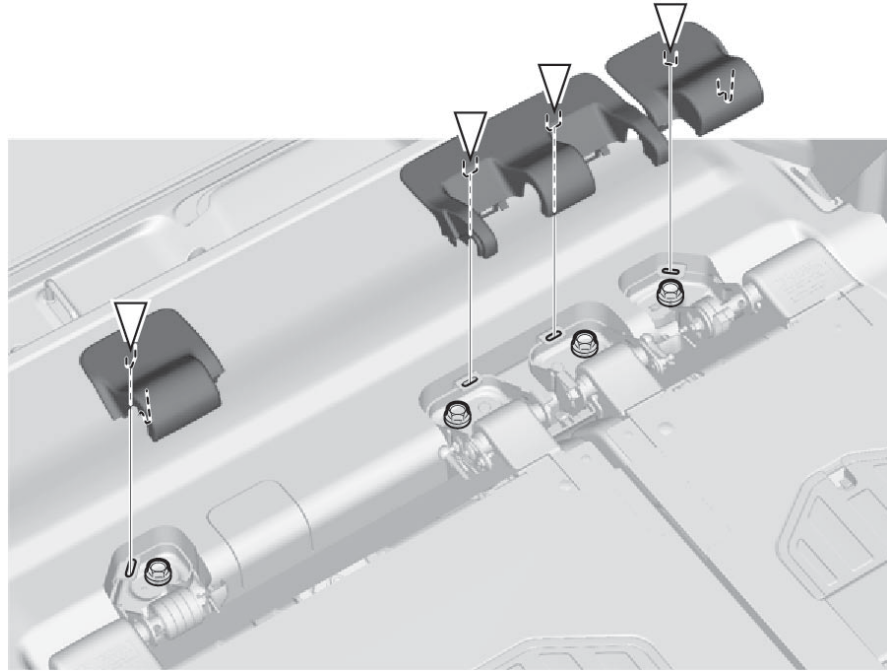

Floor Area

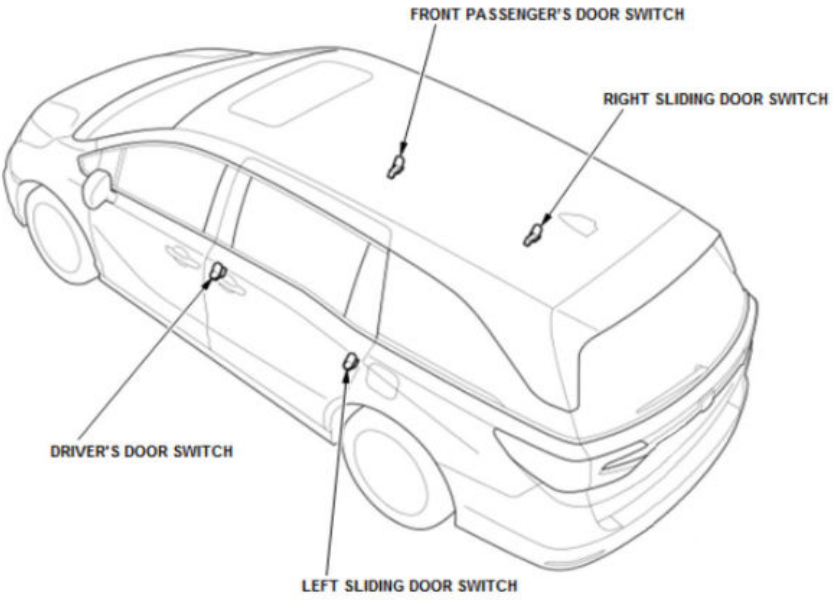
	Component / Action	Notes
17	Door Switches Remove.	Remove the driver's, front passenger's, left sliding and right sliding door switches. 
18	Taillights Remove.	<ul style="list-style-type: none">• Remove both taillights.• Refer to Taillight Removal and Installation.

Harness Removal

NOTES

- Before removing the harness from the vehicle, mark each harness clip with a **C** and ground locations with a **G**. This will help you with the correct routing when installing the new harness.

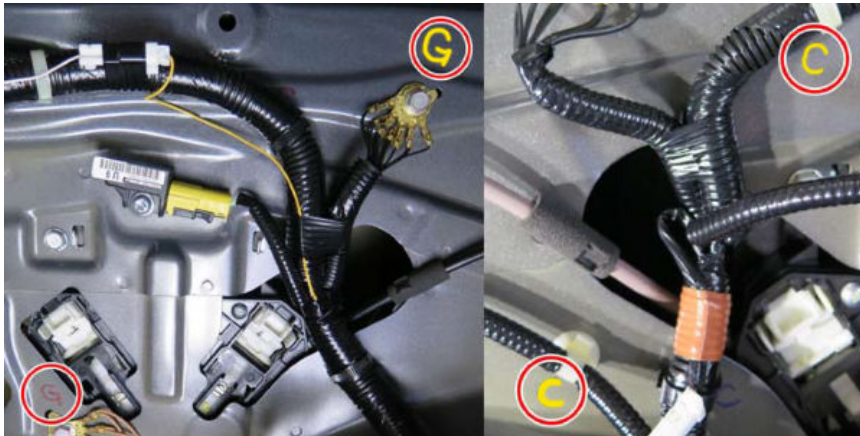

- Taking pictures prior to the removal is recommended so it can be referenced later.
- Zip tie or tape together sections of the harness as they are being removed for easier removal out of the vehicle.

Harness Removal

Start from the front and work your way back.

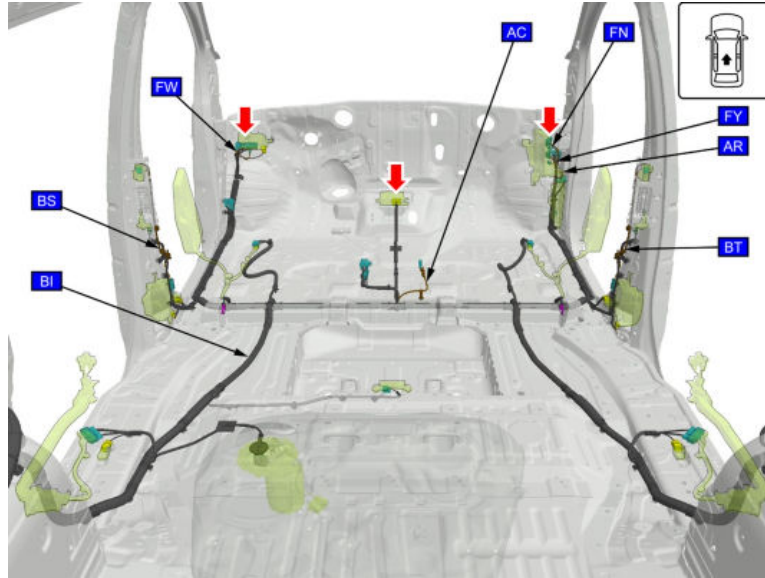

Remove Harness

1 (Front to Middle Section)

If necessary, remove the driver's knee airbag to disconnect the under-dash fuse box connector B. Refer to Driver's Knee Airbag Removal and Installation.

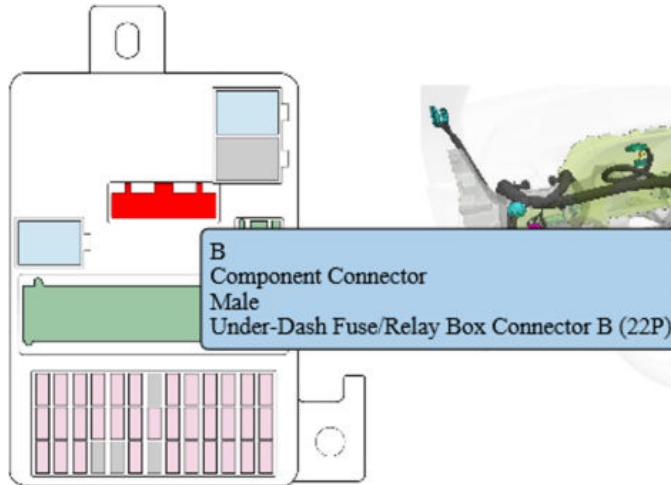

Harness Removal

Left Side

Start from the rear cargo light to the left-side curtain airbag. Then, work your way down the C-pillar, the rear side to the taillight, and down the wheel well to the harness body plug.

NOTE

When you reach the floor harness body plug, stop.

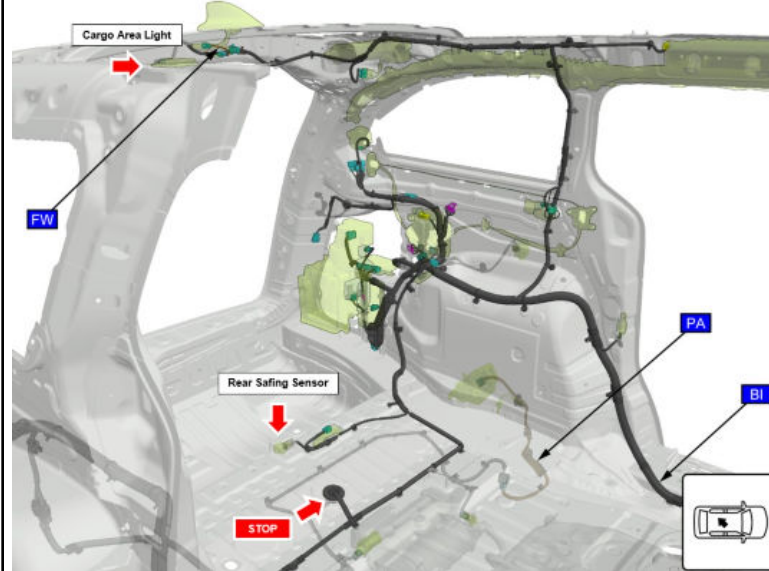

2

Remove Harness
(Middle to Rear)

Harness Removal

When you reach the rear safing sensor connector, do the following:

1. Pull back the rear floor carpet to expose the rear safing sensor.



2. Loosen (halfway) the **A** bolt, then remove the **B** bolt.

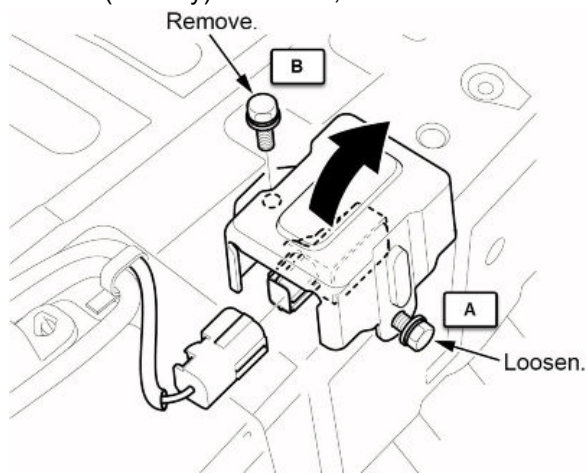

3. Tilt the cover as necessary, and disconnect the connector.



NOTE

Torque bolts **A** and **B** to **9.4 Nm (6.9 lb.ft)** after the new harness is installed.

Remove Harness
(Middle to Rear)

Harness Removal

Right Side / Roof Area

Start from the RES screen (if equipped) or the right-side curtain airbag. Then, work your way down the C-pillar, the rear side to the taillight, and down the wheel well to the harness body plug.

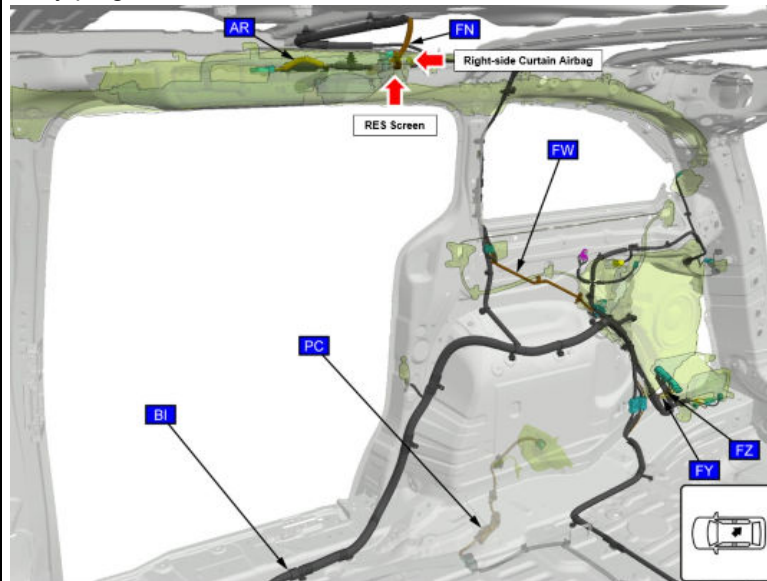

Remove Harness

(Middle to Rear)

NOTE

Do not disconnect inline connectors, C210, C235, and the pink MOST ring connector. Continue to the floor harness body plug.

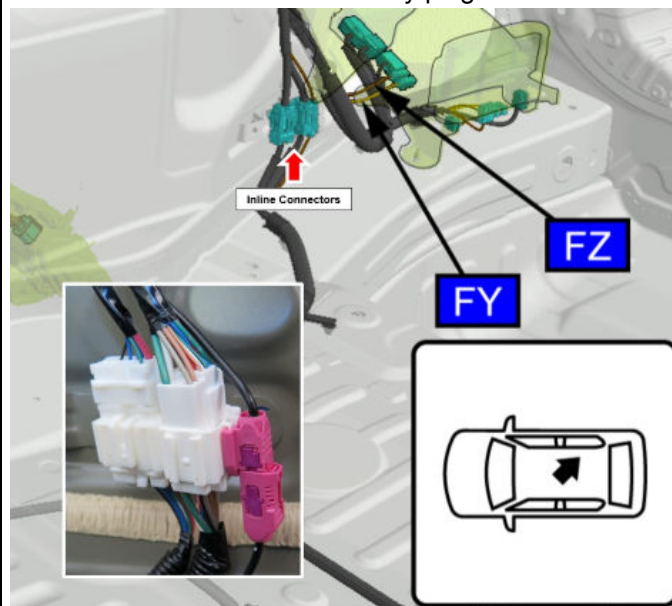

- 3 Pull the body plug, and pull the under-floor branch of the harness through the body plug hole.
- 4 Remove the harness from the vehicle.

Harness Installation

	Component / Action	Notes
1	Install the harness in the reverse order of removal, using new bolts and tape as listed in the parts information section of page 1.	
	Installation Note #1	<p>When installing the floor harness branch right below the left-side C-pillar, make sure the accessory power socket and RES connector (if equipped) is routed as shown.</p> 

Harness Installation

Component / Action

Notes

Apply commercially available aluminum tape to locations **A** and **B**.

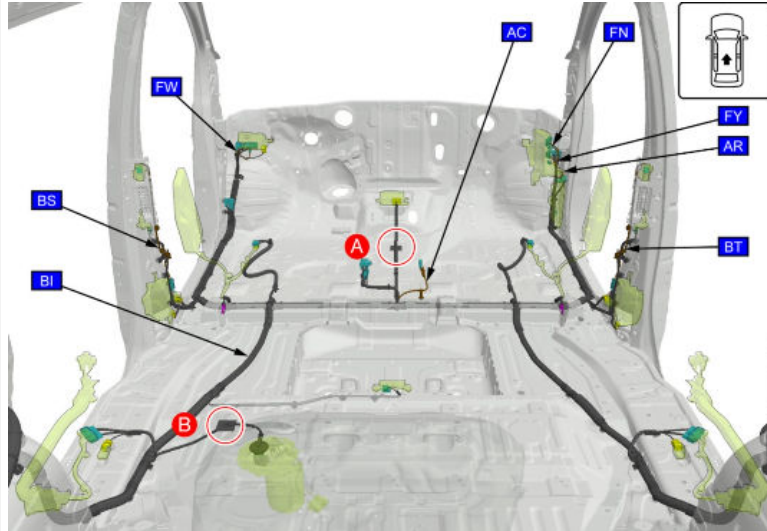

Location A

Center the new harness between the two mounds, and apply the tape. The center of the tape should be centered on the white harness tape.

Installation Note #2

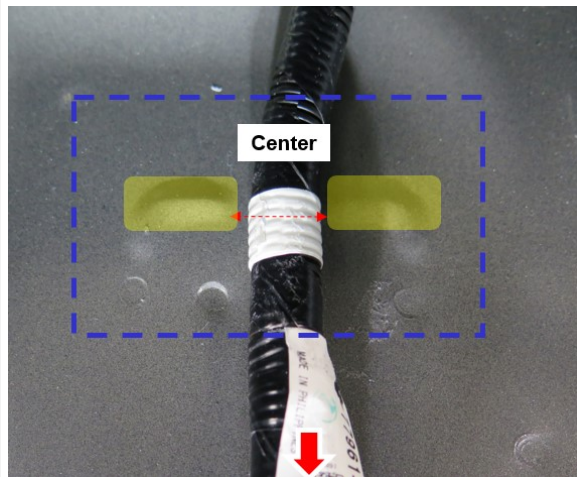

Harness Installation

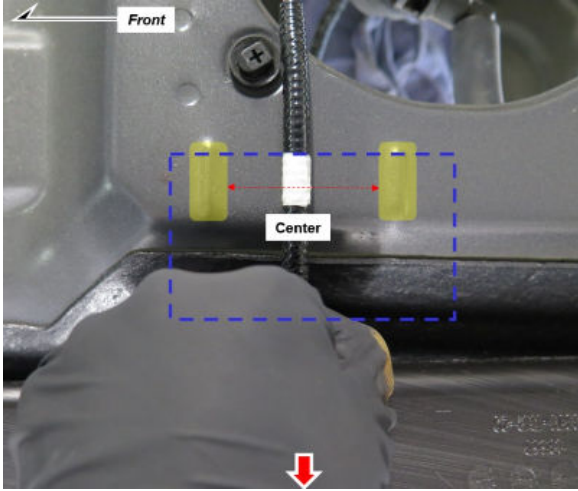
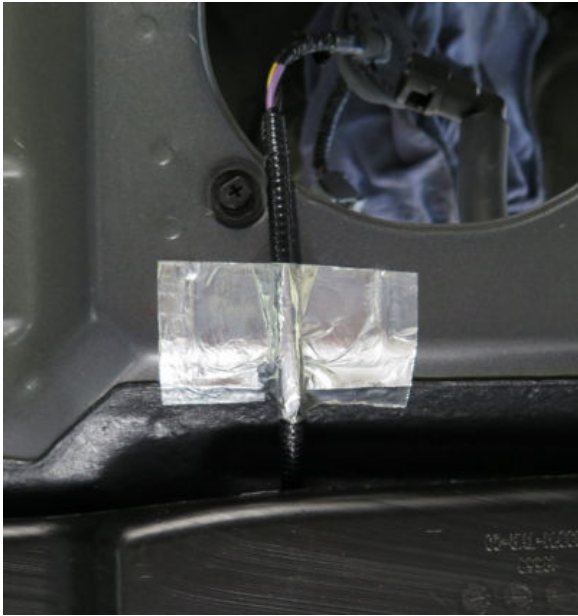
	Component / Action	Notes
	<p>Installation Note #2</p>	<p>Location B</p> <p>Center the new harness between the two mounds, and apply the tape. The top edge of the tape should line up with the edge of the white harness tape.</p>  
	<p>Installation Note #3</p>	<p>Torque all ground bolts to 9.4 Nm (6.9 lb.ft)</p>
2	<p>Reset the power sliding door control unit (if necessary).</p> <p>Refer to Resetting the Power Sliding Door Control Unit.</p>	
3	<p>Reset the power tailgate control unit (if necessary).</p> <p>Refer to Resetting the Power Tailgate Control Unit.</p>	

END