

October 1, 2020

Version 1

Safety Recall: Driver's Frontal Airbag Inflator (NADI-Factory Installed)

AFFECTED VEHICLES

Year	Model	Trim Level	VIN Range
1998	2.2CL	ALL	Check the iN VIN status for eligibility.
1998–99	2.3CL	ALL	Check the iN VIN status for eligibility.
1998–99	3.0CL	ALL	Check the iN VIN status for eligibility.
2001	3.2CL	ALL	Check the iN VIN status for eligibility.
2001	MDX	ALL	Check the iN VIN status for eligibility.
1998–2000	3.5RL	ALL	Check the iN VIN status for eligibility.
1999–2000	3.2TL	ALL	Check the iN VIN status for eligibility.

BACKGROUND

Certain vehicles were produced with a Takata Non-Azide Driver's airbag Inflator (NADI) that may contain an aluminum seal that could allow moisture to enter into the inflator. If the propellant in the inflator absorbs a large amount of moisture, the airbag may deploy slowly. If the propellant degrades due to drying or other factors, excessive internal pressure may be generated in the inflator during deployment, which may cause the inflator container to rupture.

NOTE

If the VIN status inquiry indicates that the vehicle is subject to any open safety recalls, make sure to also complete those recall repairs before returning the vehicle to the client. If you are unable to complete any open recalls, advise the client of the recall status and when the recall could be completed.

CLIENT NOTIFICATION

Owners of affected vehicles will be sent a notification of this campaign.

Do an iN VIN status inquiry to make sure the vehicle is shown as eligible.

Some vehicles affected by this campaign may be in your used vehicle inventory.

Failure to repair a vehicle subject to a recall or campaign may subject your dealership to claims or lawsuits from the client or anyone else harmed as a result of such failure. Before selling a vehicle in inventory, always check if it is affected by a safety recall by conducting a VIN status inquiry.

CORRECTIVE ACTION

Inspect the driver's airbag module and inflator. If you find an affected inflator, replace the driver's airbag inflator and use the V-SMART tool to document the installation. Then, return the original, undeployed inflator as directed.

CLIENT INFORMATION: The information in this bulletin is intended for use only by skilled technicians who have the proper tools, equipment, and training to correctly and safely maintain your vehicle. These procedures should not be attempted by "do-it-yourselfers," and you should not assume this bulletin applies to your vehicle, or that your vehicle has the condition described. To determine whether this information applies, contact an authorized Acura automobile dealer.

PARTS INFORMATION

Part Name	Part Number	Quantity
Inflator Kit	04770-S01-306	1
Torx Bolt (6 x 23) (The inflator kit includes the Torx bolts. Order this if you only did the inspection.)	90134-S6A-A80	2
Lock Nut (Order this only if instructed in step 21 or 22.)	77854-TL0-E81	4

NOTES

- Always use new Torx bolts to reinstall the airbag module. The new Torx bolts are coated with threadlock to make sure they do not come loose.
- The inflator kit box must be used to return the old inflator to its supplier. Be careful not to damage the inflator kit box.
- If the defective, undeployed inflator is not returned, the warranty claim for that vehicle will be charged back to your dealership.
- To return the inflator, follow the instructions in PIB B15-0006, *Inflator Kit Return Process*.
- Parts staff can scan the part number and serial number from the outside of the box into the warranty claim by using the **Controlled Part Serial No.** screen and scanning the applicable information. Refer to the job aid *Ordering and Managing Replacement Inflators* for more information.

WARRANTY CLAIM INFORMATION

NOTES

- To avoid a warranty claim being charged back to your dealership, the defective, undeployed inflator must be returned to its supplier. Follow the shipping instructions in PIB B15-0006, *Inflator Kit Return Process*.
- The **replacement inflator part number and serial number** must be printed on the RO.
- To avoid non-payment of warranty claims, the new airbag inflator part number and serial number must be included in each claim. For more information, refer to step 12 of REPAIR PROCEDURE.
- The serial number is encoded into the bar code printed on the label inside of the box and on a label attached to the outside of the box. If your dealership uses a scanner, you can scan the serial number from either place into the claim.
- The part number is encoded into a barcode attached to the outside of the box. If your dealership uses a scanner, you can scan the part number into the claim.
- **If you confuse the serial number and part number when entering the claim information**, your claim will automatically be rejected.
- For more information about scanning and filing airbag inflator recall claims, refer to **Ordering and Managing Replacement Airbag Inflators**. From the iN, select **Service, Service Library**, then **Claims Reference Guide**. Under **HOT TIPS/TOPICS**, select **More info...** next to **Inflator Claims at Glance**.

Operation Number	Description	Flat Rate Time	Defect Code	Symptom Code	Template ID	Failed Part Number
7521P6	Replace the inflator, do the V-SMART procedure, then install the airbag module.	0.5 hr	6NA00	Z8G00	B20042A	06770-SY8-A80ZA
7521P7	Remove and inspect the inflator, do the V-SMART procedure, then install the airbag module.	0.3 hr	6NA00	Z8G00	B20042B	06770-SY8-A80ZA

Skill Level: Repair Technician

REPAIR PROCEDURE

NOTES

- If the VIN status inquiry indicates that the vehicle is subject to any open safety recalls, make sure to also complete those recall repairs before returning the vehicle to the client. If you are unable to complete any open recalls, advise the client of the recall status and when the recall could be completed.
 - Make sure you have the anti-theft code for the audio and navigation system (if applicable), then write down the audio unit presets.
 - Be careful not to damage any parts when replacing the inflator, and **follow the procedure exactly**.
 - If, before removing the airbag module, you suspect that it may be the incorrect airbag module for the vehicle or a counterfeit, **do not remove the airbag module**. Contact your DPSM for assistance.
 - Do not open the inflator kit until you have confirmed an affected inflator is installed in the vehicle because if you have to return the inflator kit, the kit must be unopened.
 - If the vehicle you are working on has an unaffected airbag module and inflator, **do not disassemble the airbag module** because the inflator cannot be installed, and you will have to replace the airbag module.
 - Make sure you have reviewed the SRS Precautions and Procedures in the service information before doing the REPAIR PROCEDURE.
1. Turn the ignition to ON. Then, check if the SRS indicator comes on for about **6 seconds**, then turns off.
 - If the indicator comes on, then turns off after about **6 seconds**, go to step 2.
 - If the indicator does not come on, or if it stays on, contact your DPSM for assistance.
 2. Disconnect the battery negative cable, and wait at least **3 minutes** before continuing.
 3. Remove the driver's airbag module. Refer to the service information.
 4. Place the airbag module, face down, on a clean shop towel.
 5. Visually inspect the airbag module, and the inflator for any unusual writing or markings.
 - If there is nothing unusual about the airbag module or the inflator, go to step 6.
 - If there are any unusual markings, like an incorrect label or a model year written in marker, the airbag module and inflator may not be the correct airbag module and/or inflator for the vehicle or it may be a counterfeit part. For more information about counterfeit airbag modules, you can refer to *safercar.gov*, enter keywords **MANAGING COUNTERFEIT**, and select **Recommended Dealer Guidance for Managing Counterfeit Air Bags** from the list. **If you suspect that the airbag module or inflator is counterfeit, do not continue this procedure**. Contact your DPSM for assistance.

NOTES

- To successfully complete this inspection and verification procedure, be sure to use the V-SMART tool along with the following steps in this bulletin.
 - Before using the tool, review the job aid *Using V-SMART for NADI Recalls*. Keep in mind there is another job aid called *Using V-SMART*, but be sure not to use it. It does not include NADI Recall information.
6. Check if the airbag module has a plastic inflator cover.

With Cover



Without Cover

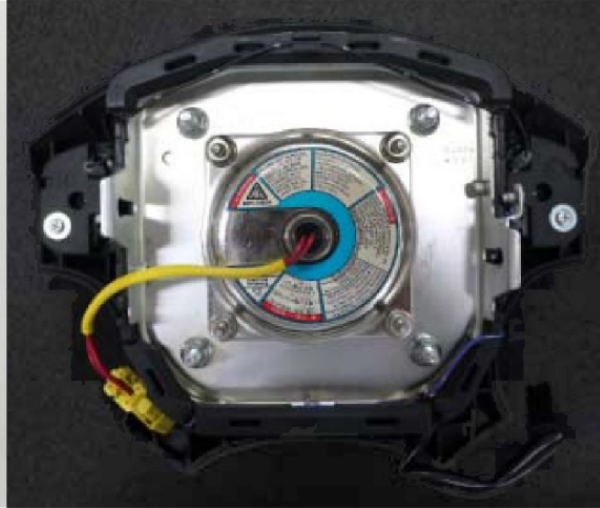

- If it does, go to step 7.
- If it does not, go to step 10.

7. Determine the type of inflator cover.

- **Inflator cover Type 1** has a cutout on the right side of the cover, and two clips at the bottom of the cover that holds the horn wire.

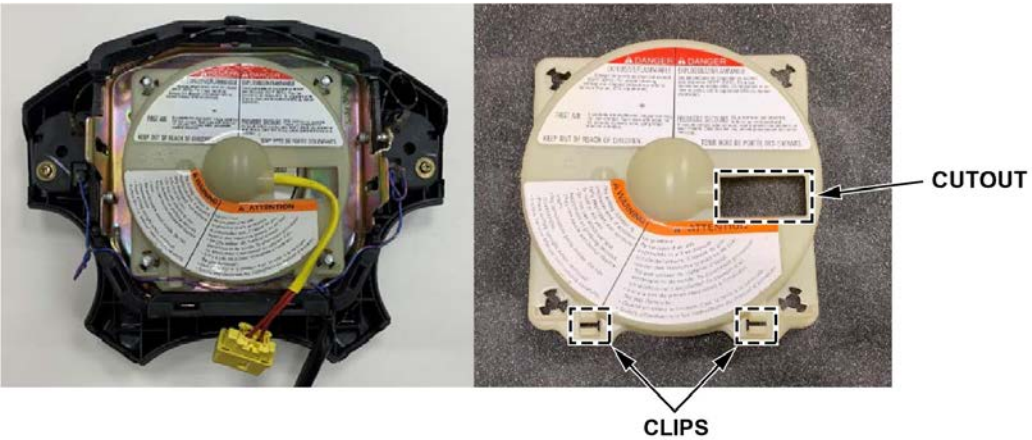

- **Inflator cover Type 2** has an L-shaped cutout at the right side of the cover.



- **Inflator cover Type 3** has two cutouts. One is at the right side of the cover, the other is at the bottom of the cover for the serial number label.

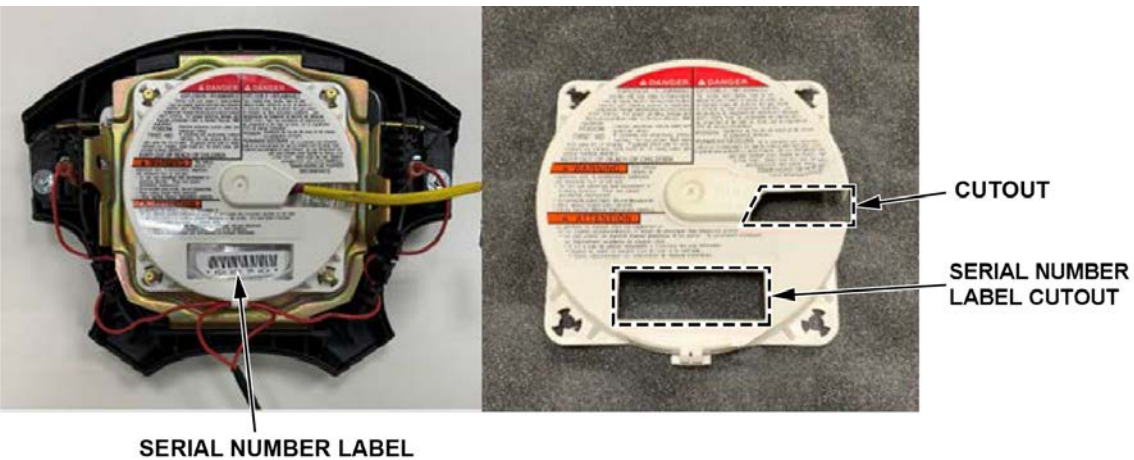

- If the inflator cover is **Type 1** or **2**, go to step 8.
- If the inflator cover is **Type 3**, this campaign does not apply. Go to step 23 to complete the V-SMART procedure and install the airbag module.

8. Remove the inflator cover (if equipped), and throw it away.
9. *Type 1 cover only*: Route the horn harness through the airbag module slot, and secure it. Then, twist any excess wire, and tuck it out of the way.

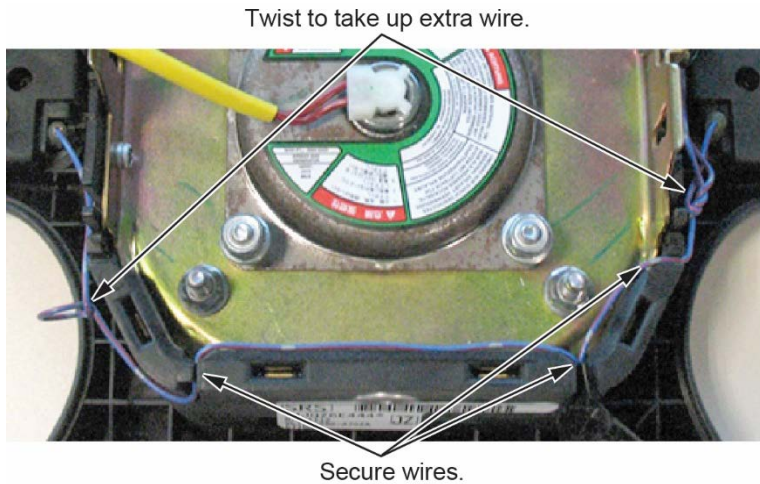

10. Compare the inflator label to the inflator labels shown below.

NOTE

Some inflator harnesses may be connected to the inflator with a connector and not by epoxy as shown below.

Inflators with epoxy shown.
Some inflators may come with connectors.

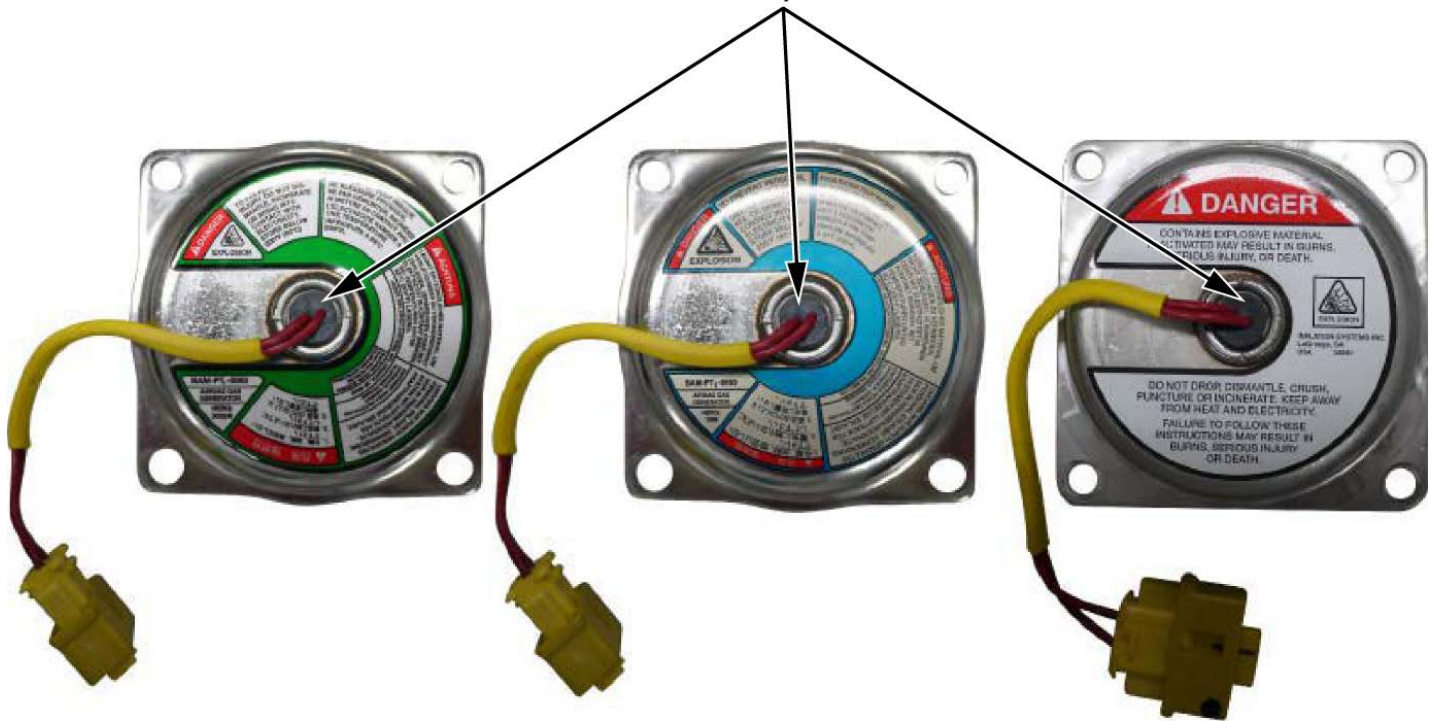

- If the inflator label matches one of the inflators shown, go to step 11.
- If the inflator label does not match any of the inflators shown, this campaign does not apply. Go to step 23 to complete the V-SMART procedure and install the airbag module.

11. Check the **M/D** number on the airbag module serial number label.

- If the last two numbers are **95, 96, 97, 98, or 99**, go to step 12.
- If the label is missing, or is unreadable, go to step 12.



Check the last two M/D numbers.

- If the last two numbers are **not 95, 96, 97, 98, or 99**, this campaign does not apply. Go to step 23 to complete the V-SMART procedure and install the airbag module.



Check the last two M/D numbers.

12. Peel the label inside the inflator box from its backing, and attach it to the RO. For the warranty claim to be paid, the **replacement inflator part number and serial number that you received** must be included in the warranty claim.

NOTES

- The replacement part number is printed on the top part of the label and the serial number is printed on the bottom. **Make sure you attach the label to the RO and give it to the warranty clerk.**
- Not all inflator kits have a label included. In those cases, write the serial number and part number from the side of the inflator box on the RO. The part number always starts with **047**.

INFLATOR PARTS BOX

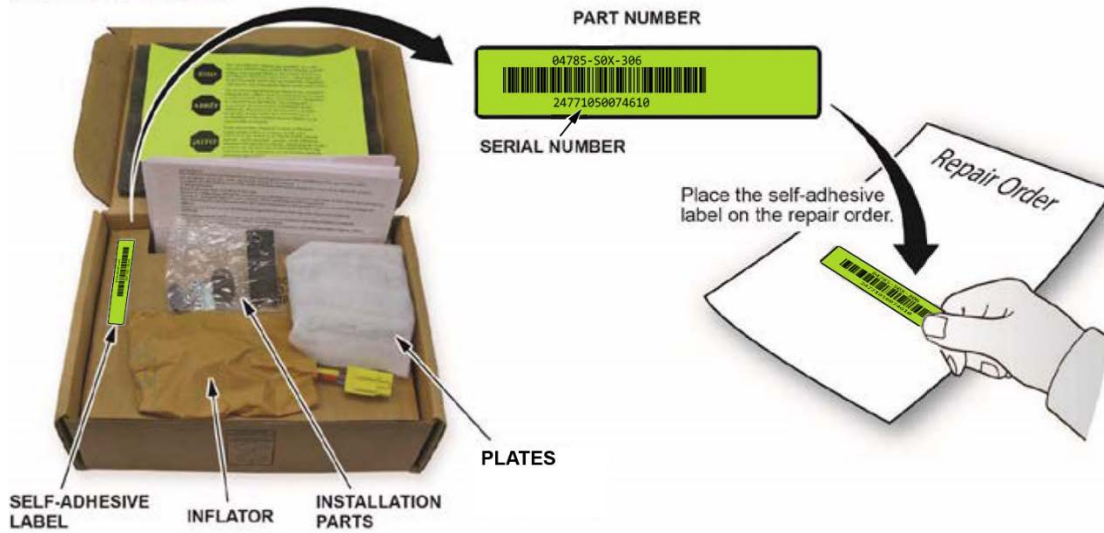

13. Using vise grips, remove the four inflator locknuts and throw them away. Do not remove the inflator from the airbag module until you complete step 14.

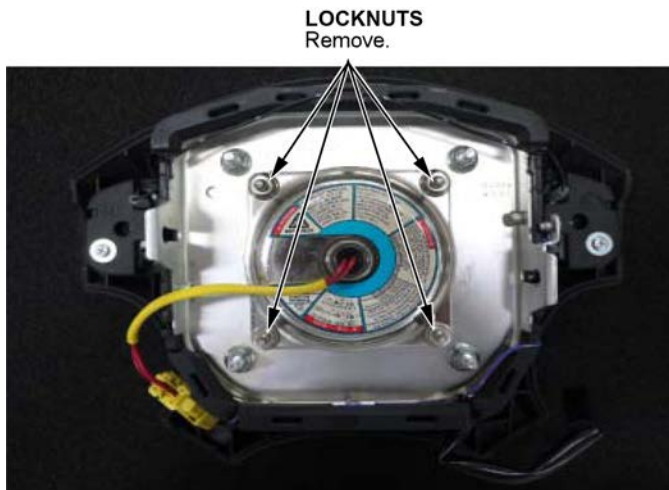

14. Use shop air to clean any debris that may be on the inflator, then remove the inflator from the airbag module.

NOTES

- Do not allow any debris to enter the inflator opening in the airbag module.
- Place the removed inflator into the kit box to return it to the supplier.
- Do not deploy the inflator. The inflator must be returned to its supplier in the box the new inflator came in. Follow the shipping instructions outlined in PIB B15-0006 to return the undeployed inflator.

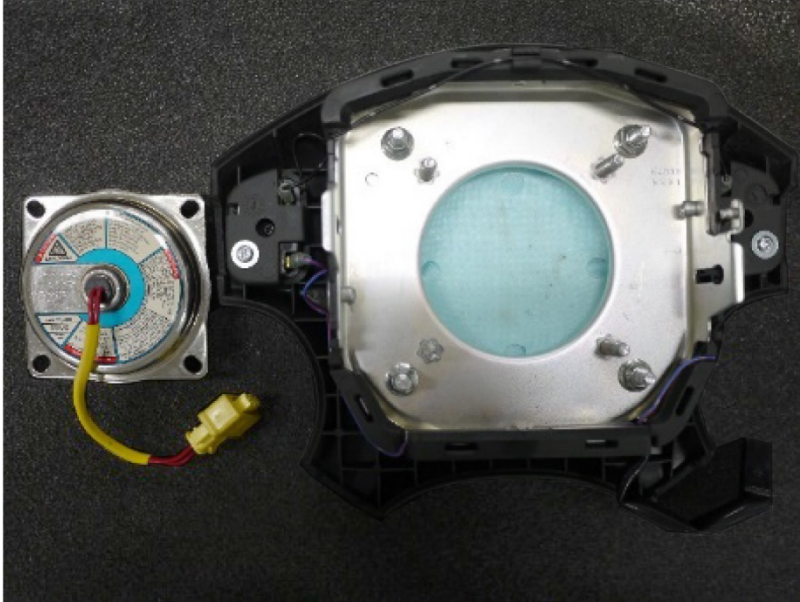

15. Make sure the **A** stamp on silver plate A is positioned on the upper right. Then, install silver plate A to the airbag module.

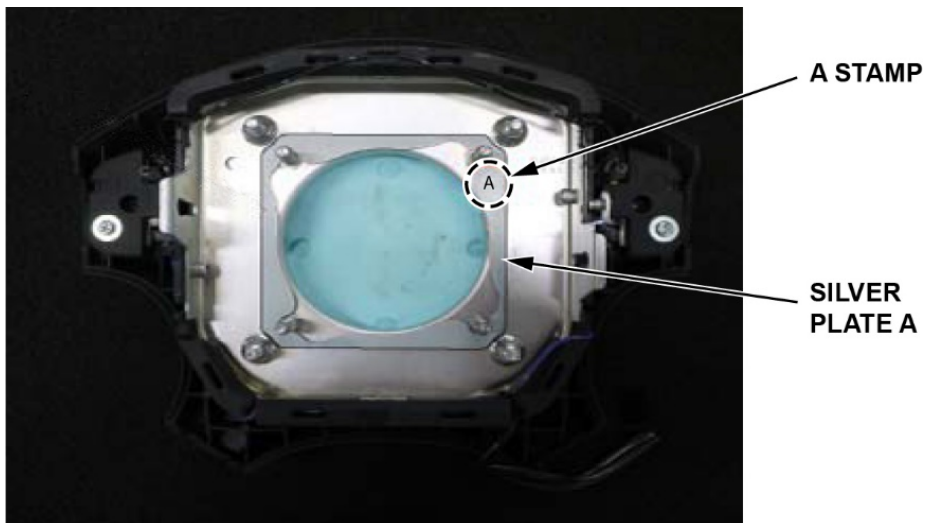

16. Install the new inflator within the opening of silver plate A with the inflator harness facing downward as shown.

NOTE

Make sure the inflator is properly placed within the opening of silver plate A, they should not be overlapping.

Make sure the inflator is properly placed within the opening of silver plate A.

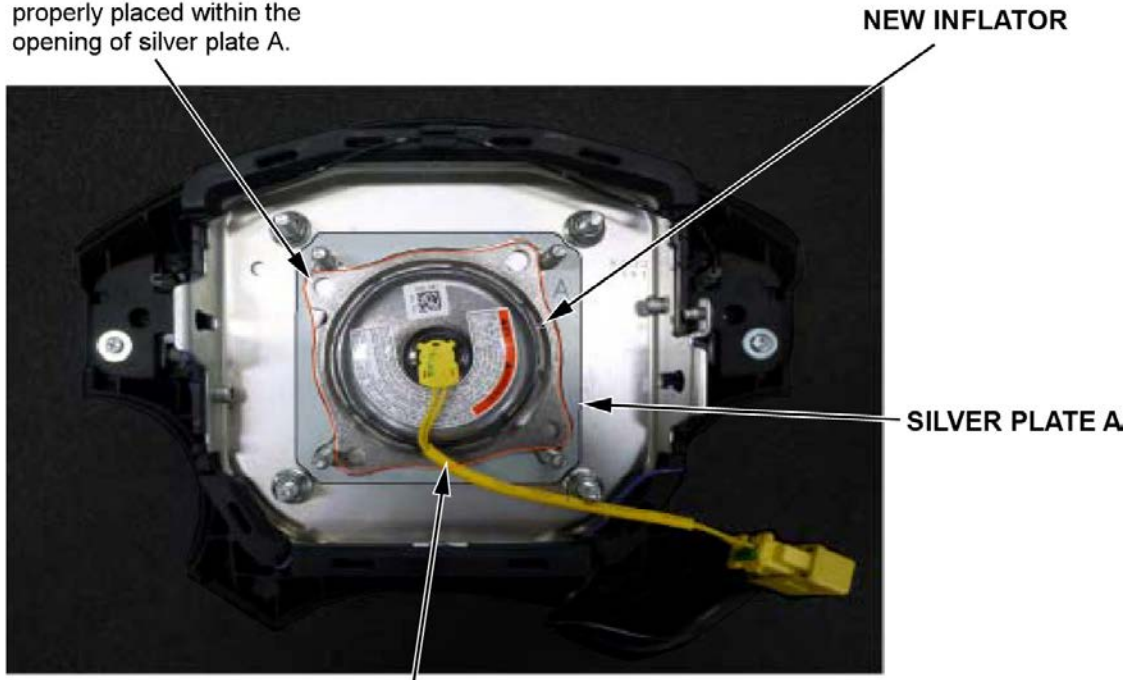

17. Make sure the **B** stamp on black plate B is positioned on the left side. Then, pass the inflator harness through the opening.

NOTE

Black plate B may have scuffs and paint peeling that occurred during packaging. There is nothing wrong with it.



18. Install black plate B to the airbag module.

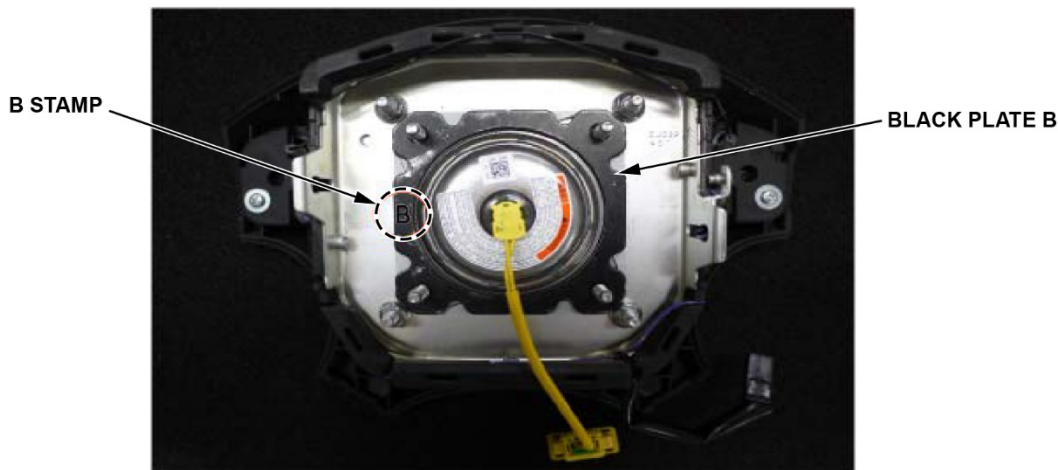

19. Make sure the inflator is installed correctly by checking the four notches on black plate B. The inflator should be within the opening of silver plate A, and not overlapping. Using a marker, mark each of the four notches after you made sure it is installed correctly. If the inflator is not installed correctly, go back to step 16.



NOTE: Make sure the inflator is within the opening of silver plate A and they are not overlapping. Check all four notches on black plate B carefully.

20. Make sure the inflator and plates are still in the correct position. Then, install new locknuts, and torque them to **6.8 N·m (5.8 lb-ft, 60 lb-in)**.



21. To ensure the inflator kit is installed properly, use a feeler gauge to make sure the space between silver plate A and the airbag module surface is no greater than **0.5 mm**. If any side is greater than **0.5 mm**, remove the inflator and go back to step 16. Be sure to replace the lock nuts (P/N 77854-TL0-E81) if you have to do it again.

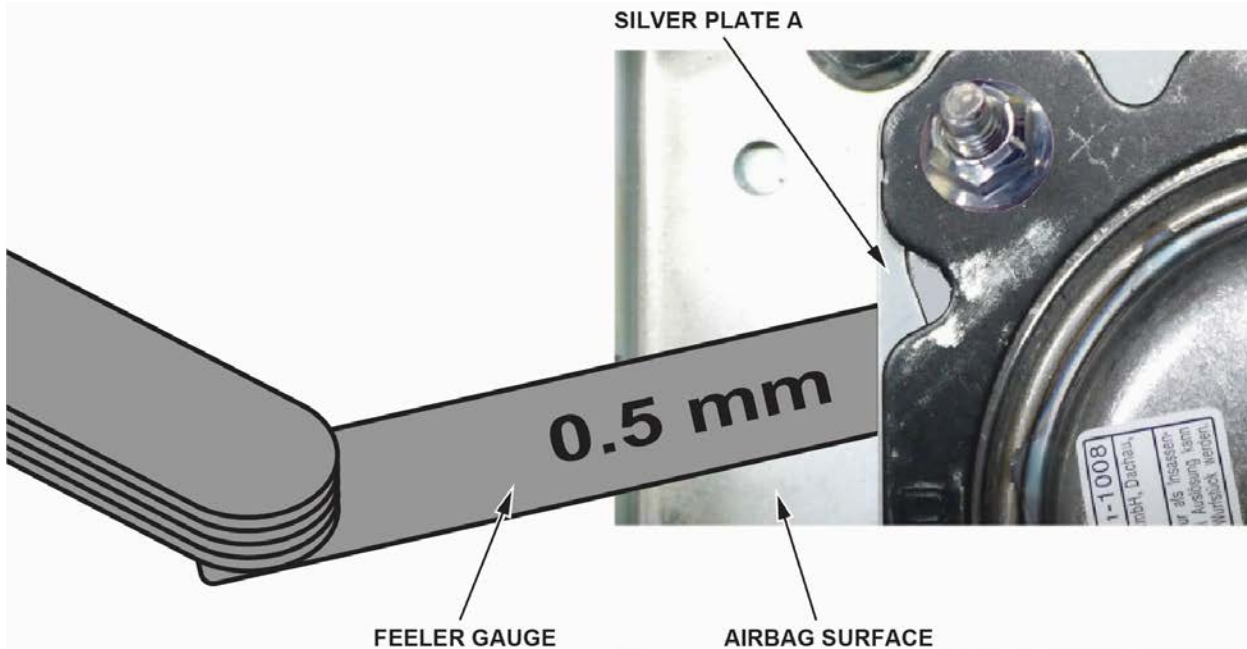

22. Use a feeler gauge to make sure the space between silver plate A and black plate B is no greater than **0.5 mm**. If any side is greater than **0.5 mm**, remove the inflator and go back to step 16. Be sure to replace the lock nuts (P/N 77854-TL0-E81) if you have to do it again.

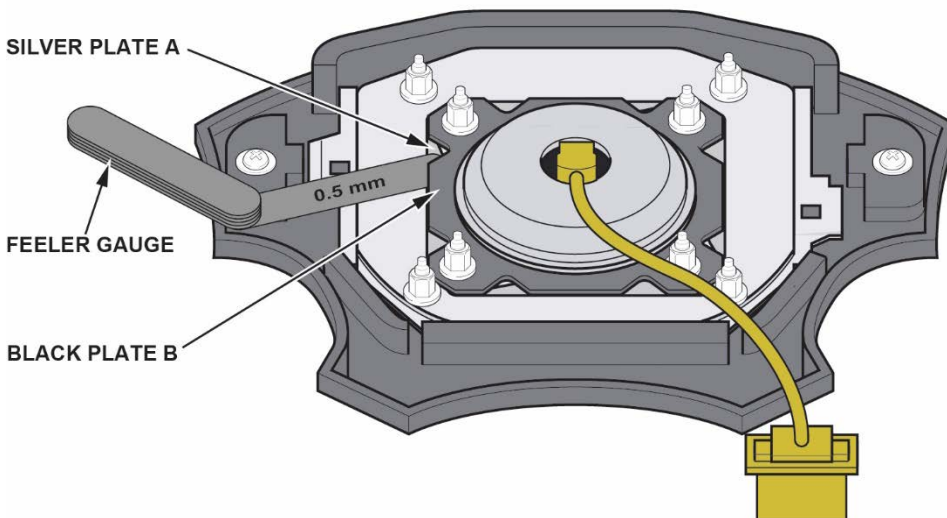

23. Follow the instructions on the V-SMART tool to complete the inspection and/or inflator replacement.

NOTES

- You must document the driver's airbag module inspection and/or replacement inflator installation using the V-SMART tool.
- **The supervisor must inspect your work and approve it** to make sure the replacement inflator was installed correctly. Your supervisor can be a service manager, shop foreman, team leader, etc. When a supervisor enters his or her information, **the supervisor is signing off that the technician's work was inspected and approved.**
- Your warranty claim will not be paid if the V-SMART validation is not completed or the photo is not sent. Make sure you see the **Uploaded Completed** message to confirm the photo was sent to the warranty department.

24. Install the driver's airbag module using new Torx bolts. Refer to the service information.

25. Connect the battery negative cable.

- Enter the anti-theft codes for the audio system and the navigation system (if equipped).
- Set the clock (on vehicles without navigation).
- Do the power window control unit reset procedure.

26. Start the vehicle. Make sure the SRS indicator comes on for about **6 seconds**, then turns off.

27. Make sure the horn works correctly.

28. Put the original inflator into the box the new one came in. Make sure there is no other hardware in the box because if the package rattles, it will not be accepted by the courier.

29. Follow the shipping instructions outlined in PIB B15-0006 to return the undeployed inflator.

30. Give your warranty clerk the RO that includes the replacement inflator serial number and replacement part number. For the warranty claim to be paid, the **replacement inflator part number and serial number that you received** must be included in the warranty claim.

END