



Mercedes-Benz

Campaign No. 2020060008, August 2022

TO: ALL MERCEDES-BENZ and FREIGHTLINER SPRINTER CENTERS

SUBJECT: **Model 906 (Sprinter)**  
**Model Year 2016**  
**Modification to the emissions control system**

Daimler Vans USA, LLC ("DVUSA") and Mercedes-Benz USA, LLC ("MBUSA") are performing an emissions campaign on certain 906 Sprinter vehicles in order to modify to the vehicles' emissions control system. EPA and CARB have approved this emissions modification for these MY16 Sprinter (Model 906) vehicles. An authorized Mercedes-Benz or Freightliner Sprinter dealer will replace certain emissions control system components and update certain software in the affected vehicles at no cost to the owner of the vehicle.

Prior to performing this Emissions Campaign:

- Please check VMI to determine if the vehicle is involved in the emissions modification campaign and if it has been previously repaired. Always Check VMI for any open campaigns, and perform accordingly.
- Please review the entire Emissions Campaign bulletin and follow the repair procedure exactly as described.

Approximately 1,826 vehicles are involved.

Order No. V-RC-2020060008

This bulletin has been created and maintained in accordance with MBUSA-SLP S423QH001, Document and Data Control, and MBUSA-SLP S424HH001, Control of Quality Records.



## Emissions Campaign 2020060008

Update August 2022

- Model: 906 Sprinter
- Model Year: 2016
- Engine: 4-Cylinder Diesel (OM 651)

## Warranty Information

Damage Code	Operation No.	Time	Operation Text
<b>Denial of AEM</b>			
49 10N 01	use operations for labor performed	up to 2 hr	Diagnosis time for pre-inspection if client declines to reverse non-compliant modifications
<b>Perform AEM</b>			
07 972 53	02 1223	1.4 hr	Perform work package for field measure
<b>Additional: Mobile AEM at customer location</b>			
21 812 00	00 9627	+50%	Mobile AEM Labor surcharge
	sublet		\$75 travel allowance
<b>Additional: Mobile AEM at customer location requiring overnight accommodation</b>			
21 813 00	00 9627	+50%	Mobile AEM Labor surcharge
	sublet		\$100 travel allowance

## Parts Overview

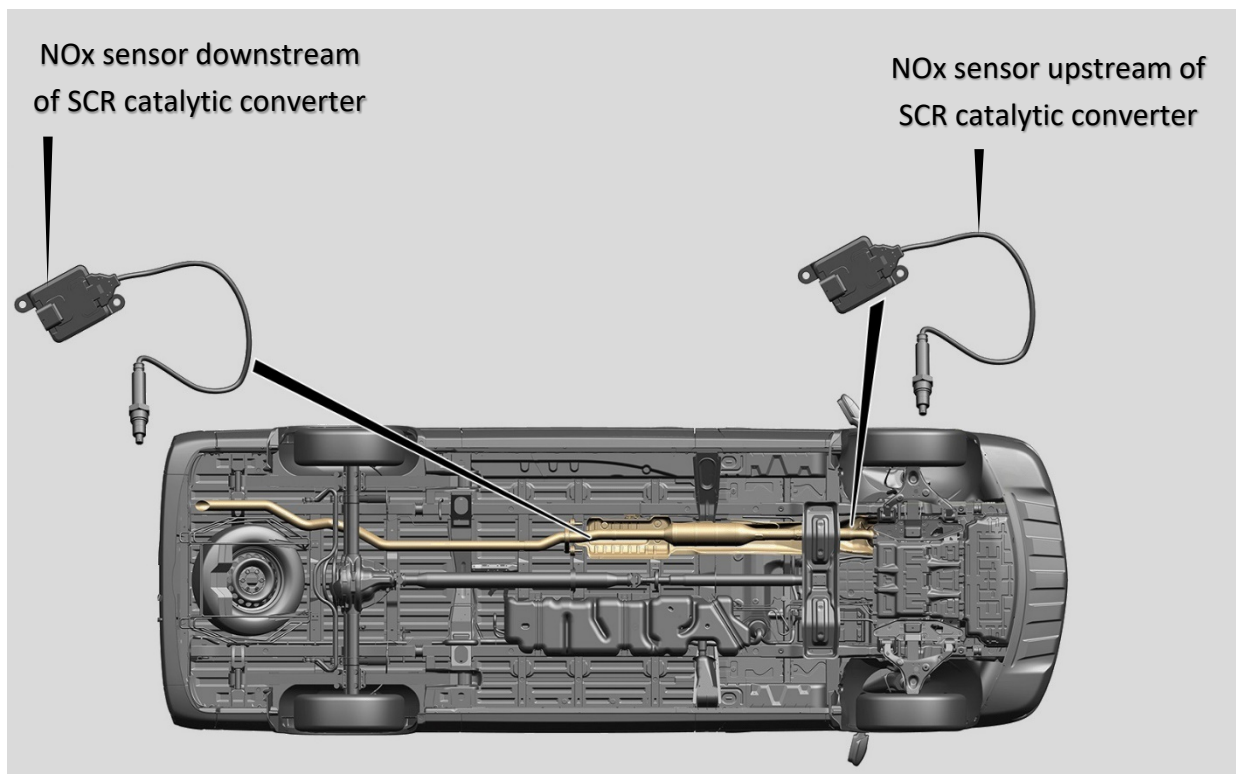

**i** Reference last page for complete list of parts to perform AEM



## Scope of Work Outline

<b>i</b> <b>Read and follow all pages of work instructions completely!</b>	<b>Page:</b>
1. Safety Notes	4-18
2. Lifting and Ramps	19-21
3. Initial Quick Test	22-28
a. Upload print-out to paperless pXD	
b. Evaluate pre-existing faults ( <i>see Pre-Inspection Guide below</i> )	
4. Pre-Inspection Special Procedure	29-32
a. Includes visual inspection of Exhaust Aftertreatment system ( <i>see Pre-Inspection Guide below</i> )	
5. Replacement of AEM parts	33-38
a. NOx Sensor Upstream of SCR Catalytic Converter	
b. NOx Sensor Downstream of SCR Catalytic Converter	
6. Execution of AEM Special Procedure	39-50
a. Includes guided steps: Software updates of CDI, ETC, IC, and SCR	
b. Fill-out and Install AEM Label	
c. Result Report to verify successful completion of all AEM steps	
i. Upload print-out to paperless pXD	
7. Final Quick Test	51-57
a. Upload print-out to paperless pXD	
b. Erase stored faults caused by the workshop	
8. Parts List	58

## Pre-Inspection Guide

- Pre-existing fault codes causing a Check Engine Light (CEL):**
  - If component causing fault will be replaced as part of the AEM:
    - Perform AEM - No additional action is needed
  - If component causing fault will be covered by the AEM Extended Warranty:
    - Perform AEM
    - Perform repair of pre-existing fault
    - Submit AEM Extended Warranty claims on a separate Repair Order after AEM claim is submitted
  - If component causing fault will not be replaced as part of AEM and not covered by AEM Extended Warranty:
    - Provide client with repair estimate, advise client AEM will not resolve Check Engine Light (CEL)
    - Document on Repair Order if client approves or declines repairs
    - Perform AEM regardless if client approves or declines repairs
  - A list of AEM Extended Warranty covered components is available in: XENTRY / CDI / Special Procedures / Exhaust Aftertreatment Service Measure / Extended Warranty
- Non-Compliant Alterations to the Exhaust Aftertreatment system found during the visual Pre-Inspection:**
  - Document all non-compliant alterations to the Exhaust Aftertreatment system on the Repair Order
  - If altered component(s) will be replaced as part of the AEM:
    - Perform AEM
  - If altered component(s) inhibit AEM installation or will sustainably affect the operation of the AEM:
    - Provide client with a repair estimate to reverse non-compliant alterations
      - If client approves repairs:
        - Reverse non-compliant alterations
        - Perform AEM
      - If client refuses repairs:
        - Do not perform AEM - Vehicle ineligible
        - Claim 'Denial of AEM' damage code and labor ops for diagnosis time performed
- If technical assistance is needed, create a PTSS case

## AEM installation Videos

Exemplary videos of the AEM installation are available via the following:

- XENTRY Workshop (XiW) / VAN / Emissions Modification Program
- Scan the QR code below with a mobile device and log-in with your XENTRY credentials

Campaign 2020060008 Video:







Risk of injury. Skin or eye injuries may result when handling hot or glowing objects.

	<b>Risk of injury.</b> Skin or eye injuries may result when handling hot or glowing objects.	Wear protective gloves, protective clothing and safety glasses, if necessary.	 Warning
--	--	---	---

### Risk of injury

Contact with hot or glowing objects without suitable protective clothing causes severe burns to skin and eyes.

When glowing objects come into contact with water, they produce hot steam or cause the water to splash, which can cause serious burns to skin or eyes.

If hot or glowing objects come into contact with unprotected skin or eyes, they can cause serious and even permanent injuries.



There is a risk of fire when glowing objects come into contact with combustible material.

### Safety precautions/instructions

- Wear protective clothing, safety glasses and heat-resistant gloves.
- Only transport hot or glowing objects with suitable aids.
- Avoid the formation of sparks and contact with combustible material when handling glowing objects.

### First aid measures

- Treat affected areas of skin with plenty of cold water and cover with sterile dressings.
- Consult a physician immediately.

Risk of accident from vehicle starting off by itself when engine running. Risk of injury (bruises and burns) resulting from working on the engine while it is being started or when it is running.

	<p><b>Risk of accident</b> from vehicle starting off by itself when engine running. <b>Risk of injury</b> (bruises and burns) resulting from working on the engine while it is being started or when it is running.</p>	<p>Secure vehicle to prevent it from starting off by itself. Wear closed and snug-fitting work clothes. Do not touch hot or rotating parts.</p>	 <b>Warning</b>
--	---	---	--

### Potential risks

#### Risk of accident

Caused by the vehicle starting off by itself during the starting procedure

(e.g. during compression test) **due to engaged gear** or with the engine running and vehicles with automatic transmission **due to selector lever position "P" or "N"** not being engaged (except for vehicles that do not have selector lever position "P").

#### Risk of injury

**Severe injuries** can be caused by freely rotating parts in the area of the running engine.

Because the engine heats up when operating, serious burns can be caused by touching unshielded parts.

#### Safety instructions/precautions

- In general, only work on a running engine when it is absolutely necessary.
- **Apply parking brake** before starting the engine.
- The vehicle is to be secured against moving forwards or backwards.
- The person performing tests on a vehicle with the engine running must sit in the driver's seat to be able to prevent the vehicle from moving.

- It is not permitted for persons to be in the danger zone in front of or behind the vehicle while tests are being performed.
- **Shift the gearshift lever to neutral** on vehicles with manual transmission.
- On vehicles with automatic transmission, move **selector lever into position "P" or "N"** (except for vehicles that do not have selector lever position "P").
- On vehicles that do not have selector lever position "P", the **selector lever** is to be **secured against unauthorized access**.
- Wear closed and snug-fitting work clothes.
- Remove all jewelry such as necklaces, rings, etc.
- Wear suitable head wear to cover long hair.
- Before commencing any work on the running engine, familiarize yourself with the location of potentially hot parts.
- When carrying out work when starting the engine or when the engine is running, **do not touch any hot or rotating parts**.
- Use the exhaust extraction system.

---

#### First aid measures in the event of burns

- Do not rub the skin areas affected; rinse with plenty of cold water and cover skin with sterile dressings.

- Consult a physician immediately.



Risk of injury. Moving parts can pinch, crush or, in extreme cases even sever extremities.

	<b>Risk of injury.</b> Moving parts can pinch, crush or, in extreme cases even sever extremities.	No parts of the body or limbs should be within the operating area of mechanical components when moving components.	 <b>Warning</b>
--	---	--	--

### Risk of injury

When working on components that can be moved either by hand, by means of electric motors, or hydraulically/ pneumatically via a connecting mechanism, serious injuries can occur due to body parts being cut, pinched or crushed.

### Safety instructions/precautions

- Monitor hazard area.

- Secure the operating area of mechanical components against interference when parts are in motion.
- Never touch the mechanism of a component while it is being actuated by electric motors via the diagnosis or by direct actuation (terminal 30).
- Choose a test cable of sufficient length.



Risk of death caused by vehicle slipping or toppling off of the lifting platform.

	<b>Risk of death</b> caused by vehicle slipping or toppling off of the lifting platform.	Align vehicle between vehicle lift columns and position the four support plates at the vehicle lift support points specified by the vehicle manufacturer.	 <b>Danger</b>
--	--	---	---

### Risk of accident and injury

Ensure that the vehicle is ideally aligned and secured against tilting according to the general safety specifications and regulations.

Non-observance of the safety specifications can cause the vehicle to **slip off** the lift system and thereby result in **life threatening** or **fatal** injuries.



This list of hazards is not complete.

The safety specifications of the respective country are always valid. The user is personally responsible for complying with these.

Risk of burn injuries and scalding when working at AdBlue® lines and the components attached to them. Risk of injury to skin and eyes when handling AdBlue®. Risk of poisoning caused by swallowing AdBlue®

	<p><b>Risk of burn injuries and scalding</b> when working at AdBlue® lines and the components attached to them. <b>Risk of injury</b> to skin and eyes when handling AdBlue®. <b>Risk of poisoning</b> caused by swallowing AdBlue®</p>	<p>Pour AdBlue® into suitable containers only. Wait until the pressure is released before starting any work on the exhaust aftertreatment system.</p>	 <b>Warning</b>
--	---	---	--

### Potential risks

#### Risk of burn injuries and scalding

The AdBlue® lines and all components attached to them are under pressure during operation and remain so after the engine is switched off and may be hot. There is a risk of burn injuries. There is a risk of scalding caused by escaping hot AdBlue® when the line system is opened.

#### Risk of injury

There is a risk of skin irritation and eye damage on contact with AdBlue®.

#### Risk of poisoning

There is a risk of poisoning if AdBlue® is swallowed.

#### Rules of conduct

- On vehicles with electrical delivery pump, the AdBlue® is pumped from the line back into the AdBlue® tank after the engine is switched off.

- On vehicles with a compressed air system, individual lines are flushed with compressed air after the engine is switched off. The engine must therefore be switched off for at least 5 minutes before work on the exhaust aftertreatment system may begin.
- Open connections and plugs on the system components slowly. Cover the connecting point with rags when opening.  
Only pour AdBlue® into marked containers specially designated for the purpose. Do not pour AdBlue® into drinking containers.
- Wipe up any AdBlue® spills immediately as there is a high risk of someone slipping.

#### Safety precautions for handling removed parts and working under the vehicle

- Wear suitable protective gloves
- Wear protective clothing
- Wear safety glasses

#### First aid measures

Contact with skin: Wash the affected skin areas with plenty of clean water. Change wetted clothing as quickly as possible.

Contact with eyes: In the event of contact with eyes, immediately rinse eyes thoroughly with plenty of clear water; contact an eye doctor if necessary.

Ingestion: rinse mouth with clean water and drink large quantities of water. Immediately seek medical assistance.

#### Firefighting measures

AdBlue® is not combustible. NH<sub>3</sub> (ammonia) can be released in the event of fire, causing a risk of poisoning. Firefighting measures must therefore be suited to the surroundings.

Risk of burn injuries, suffocation and poisoning when working on the exhaust system and the components connected to it. Risk of suffocation and risk of poisoning caused by inhalation of gaseous and solid components of the exhaust. Risk of poisoning caused by skin contact with solid components of the exhaust.

	<p><b>Risk of burn injuries,</b> suffocation and poisoning when working on the exhaust system and the components connected to it. Risk of suffocation and risk of poisoning caused by inhalation of gaseous and solid components of the exhaust.</p> <p><b>Risk of poisoning</b> caused by skin contact with solid components of the exhaust.</p>	<p>Wear protective clothing and safety glasses. Use the extraction system. Move people out of the hazard area.</p>	<p> Warning</p>
--	---	--	--

### Risk of burn injuries

The exhaust system and all components connected to it are very hot during operation and remain so after the engine is switched off. Do not touch hot parts.

### Risk of suffocation and poisoning

Exhaust gases may also cause cancer.

At higher concentrations, irritation of mucous membranes and headaches may occur. Carbon monoxide may cause damage to unborn children.

Avoid inhalation of exhaust gases; wear respiratory protection.

Use the exhaust extraction system.

### Risk of injury

Risk of injury to the eyes, skin, and respiratory paths due to contact with exhaust residues such as diesel particulates

and diesel soot. To prevent skin contact on hands, wear nitrile gloves.

### First aid measures

#### In the event of inhalation:

Move victim from the hazard area to fresh air without endangering yourself and consult a physician immediately.

#### After contact with skin:

Immediately wash affected areas of the body with plenty of soap and water. Employees who have experienced skin contact must consult a physician immediately.

#### After contact with eyes:

Rinse eyes thoroughly with running water for at least ten minutes with the eyelids wide open and contact an eye doctor immediately.

Risk of explosion from explosive gas. Risk of poisoning and caustic burns from swallowing battery electrolyte. Risk of injury through burns to skin and eyes from battery acid or when handling damaged lead-acid batteries

	<b>Risk of explosion</b> from explosive gas. <b>Risk of poisoning and caustic burns</b> from swallowing battery electrolyte. <b>Risk of injury</b> through burns to skin and eyes from battery acid or when handling damaged lead-acid batteries	No fires, sparks, open flames or smoking. Wear acid-resistant gloves, clothing and glasses. Only pour battery acid into suitable and appropriately marked containers.	 Danger
--	--	---	--

### Potential risks

#### Risk of explosion

When charging lead batteries with battery electrolyte containing sulfuric acid, a highly explosive oxyhydrogen gas mixture is created that ignites by means of fire, sparks, open flames and smoking.

#### Risk of injury

The battery electrolyte contains diluted sulfuric acid that causes caustic burns to the skin, eyes and mucous membranes in the event of contact. Bonded electrolyte is just as caustic as liquid electrolyte. Battery electrolyte mist causes caustic burns to the eyes. If inhaled, this can result in caustic burns to the mucous membranes and respiratory paths. In the event of a short circuit from the battery positive to ground, battery terminals and conductive objects causing short circuit, e.g. tool or jewelry (watch band or

ring), become hot in seconds and red hot/liquid metal sprays are released.

#### Risk of burn injuries

In the event of a short circuit from the battery positive to ground, battery terminals and conductive objects causing short circuit, e.g. tool or jewelry (watch band or ring), become hot in seconds and cause burns.

#### Risk of poisoning

**If battery electrolyte is swallowed**, this can result in symptoms of poisoning such as headache, dizziness, stomach ache, respiratory paralysis, unconsciousness, vomiting, caustic burns and cramps. Absorption of lead in the body through contact with leaded components (battery terminals, lead plates in damaged batteries) damages the blood, nerves and kidneys; lead compounds are also toxic for reproduction.

### Safety precautions/instructions

- Wear acid-resistant gloves and clothing and safety glasses with side guards.
- Only charge lead batteries in well ventilated rooms with appropriate voltage and appropriate current with approved chargers, taking into account the instructions of the battery and battery charger manufacturers.
- No fire, sparks, open flames and smoking.
- Switch on the battery charger only after connecting to the terminals; switch off the battery charger before disconnecting from the terminals.
- Do not place any conductive objects on the battery and do not wear any conductive jewelry (risk of short circuit).
- Always disconnect the negative terminal first; always connect the positive terminal first (risk of short circuit caused by tool).
- Strict caution is required when handling damaged batteries (removing from vehicle damaged in accident) because of the sharp edges on the fractured housing and escaped electrolyte.
- Keep batteries and battery electrolyte away from unauthorized persons (especially children).
- Only fill liquid battery electrolyte into suitable and appropriately marked containers.
- Only store, transport and install batteries with liquid battery electrolyte horizontally, otherwise battery electrolyte can escape from the degassing holes.
- Ensure that at least one degassing hole at the battery is not sealed, as otherwise overpressure builds that leads to bursting of the battery.
- Ensure proper connection of the degassing line to the degassing hole.
- Ensure the degassing line does not have any kinks and is not blocked at any point.
- Observe the instructions for use for the respective lead batteries and the operator's manual of the vehicle.
- The battery housing may become brittle over time, therefore do not expose the battery to direct sunlight.
- Discharged batteries may freeze and are thereby damaged, therefore always store batteries at a location protected against frost.

Risk of explosion from explosive gas. Risk of poisoning and caustic burns from swallowing battery electrolyte. Risk of injury through burns to skin and eyes from battery acid or when handling damaged lead-acid batteries

### First aid measures

#### Contact with eyes

- Rinse eyes immediately with plenty of water.

#### Contact with skin

- Remove wet clothing.
- Immediately neutralize battery electrolyte on the skin or clothing with acid neutralizer or soapy water and rinse off with plenty of water.
- Wash off lead on the skin immediately with water and soap.

#### Inhalation of battery electrolyte mist

- Take the affected person out into the fresh air.

### Swallowing battery electrolyte

- Have the person affected drink plenty of water with activated charcoal supplement.

**As a general rule, the person affected should consult a medical service or physician after first aid has been rendered.**

### Fire protection measures

Suitable extinguishing agents

- CO<sub>2</sub> and dry extinguishing agent

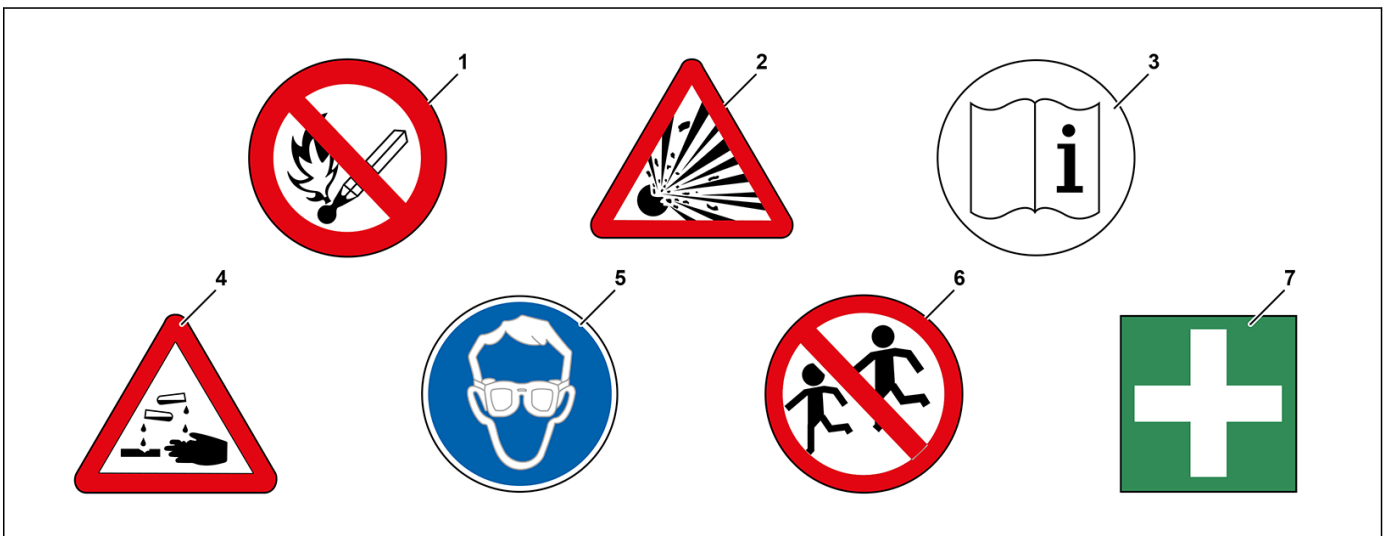

### Warning notes for lead batteries with battery electrolyte containing sulfuric acid

- |   |   |   |                       |   |                         |
|---|---|---|-----------------------|---|-------------------------|
| 1 | No fire, sparks, open flames or smoking | 4 | Risk of caustic burns | 6 | Keep away from children |
| 2 | Risk of explosion                       | 5 | Wear eye protection   | 7 | First aid               |
| 3 | Observe operating instructions          |   |                       |   |                         |



## Risk of injury caused by contact with battery gel when handling damaged lead-gelbatteries

	<b>Risk of injury</b> caused by contact with battery gel when handling damaged lead-gelbatteries	No fires, sparks, open flames or smoking. Wear acid-resistant gloves, clothing and glasses.	<b>Warning</b>
--	--	---	----------------

**Potential risks**
**Risk of poisoning**

**Swallowing battery gel** can cause symptoms of poisoning such as headaches, dizziness, stomach aches, respiratory paralysis, unconsciousness, vomiting, caustic burns and cramps.

**The absorption of lead in the body** can cause damage to blood, nerves and kidneys; in addition, lead compounds are considered to represent a reproductive hazard.

**Risk of injury**

**The bonded electrolyte set free** is just as caustic as a liquid electrolyte that can cause heavy caustic burns to skin and eyes. Strict caution is required when handling damaged lead-gel batteries (e.g. removing from vehicle damaged in accident) because of the sharp edges on the fractured housing and direct contact with the lead plates.

**Safety precautions and rules of conduct**

- No fires, sparks, open flames or smoking.

- Do not place any tool or other conductive object on the lead-gel battery (risk of short circuit!).
- Disconnect and remove lead-gel batteries for charging.
- Always **disconnect the negative terminal first** and always **connect the positive terminal first**.
- Only switch on the battery charger after connecting to the terminals and switch off before disconnecting.
- Keep lead-gel batteries away from unauthorized persons (especially children).
- Pay attention to instructions for use of the particular lead-gel battery and the operator's manual for the vehicle.
- Wear acid-resistant clothing and safety glasses with side guards.
- Only pour acid gel into suitable and appropriately marked containers.

**First aid measures**
**Contact with eyes**

- Rinse out eyes immediately with plenty of water.

**Contact with skin**

- Remove moistened clothing.
- Immediately neutralize drops of acid or gel on skin or clothing with acid neutralizer or soapy water and rinse off with plenty of water.

**Swallowing battery gel**

- Have the person affected drink plenty of water supplemented with activated charcoal.

**After performing first aid, always consult medical service or a physician.**

**Fire protection measures**
**Suitable extinguishing agents**

- CO<sub>2</sub> and dry extinguishing agent

## Notes on avoiding damage through contamination and foreign objects

	Notes on avoiding damage through contamination and foreign objects		Topical note
--	--	--	--------------

**Information on affected component parts**

With each maintenance and repair work to the engine as well as to the ancillary assemblies and detachable parts comes the danger of property damage caused by contamination and foreign bodies.

Particularly at risk are:

- Exhaust gas turbocharger
- Hot film mass air flow sensor
- Compressor
- Emission control system
- All components involved in gas exchange

**Notes on removal/installation**

Openings through which soiling or foreign objects are introduced into the engine, its ancillaries or detachable parts, must be sealed immediately.

For this purpose, suitable, clean covers and plugs or clean, lint-free rags are to be used.



Do not forget to remove all covers, plugs or rags when assembling or when finalizing the work.

This avoids any damage and complaints about engine running characteristics.



Before assembling or finalization work all components are to be checked for soiling, left-over foreign objects and any fluids, and if any are found they are to be removed.

**Information on cleaning**

For cleaning, use only clean tools and clean, lint-free rags.

Residues of cleaning agents and removed contaminants must be cleared from the engine, ancillary assemblies and detachable parts.



Do **not** use compressed air for removing any soiling. Otherwise, components (e.g. the hot-wire element of the hot film mass air flow sensor) could be damaged or contamination could enter the engine, ancillary assemblies and detachable parts without being noticed.



## Notes on use, material properties and handling of AdBlue®

	Notes on use, material properties and handling of AdBlue®		Topical note
--	---	--	--------------

**Tasks of AdBlue®**

AdBlue® serves to convert nitrogen oxides into water vapor and nitrogen.

**Chemical characterization and composition of AdBlue®**

The urea content is 32.5%. AdBlue® consists of urea dissolved in demineralized water. AdBlue® is not an additive.

Chemical formula: H<sub>2</sub>N-CO-NH<sub>2</sub>

Molecular weight (urea): 60.06 g/mol

CAS (Chemical Abstracts Service) no.: 57-13-6

**Marking**

AdBlue® dispensers are marked with the standard designation ISO 22241 or with the trade designations AdBlue® or Diesel Exhaust Fluid (DEF).

**Transport**

In vehicles with BlueTEC technology, AdBlue® is carried in a tank.

**Physical and chemical properties of AdBlue®**

State: Liquid

Color: Colorless, clear, light-yellow

Odor: Slight ammonia odor

pH value: 10 (aqueous solution, 10 %)

Crystallization temperature: -11 °C / 12 °F

Boiling point: 103 °C / 217 °F

Auto-ignition temperature: Not spontaneously inflammable

Density: approx. 1.09 g/cm<sup>3</sup> at 20 °C / 68 °F

Viscosity (dynamic): approx. 1.4 mPa\*s at 25 °C / 77 °F

**Handling contaminated operating fluids**

It is essential that AdBlue® be kept separate from other operating fluids, fuels and lubricants such as coolant,

engine oil, transmission oil, fuel, hydraulic fluid and brake fluid and not used in the same containers and collecting bowls. The smallest amounts of AdBlue® can damage thermostats or temperature sensors.

Operating fluids which contain traces of AdBlue® must not be used again.

**Handling contaminated AdBlue®**

AdBlue® must be checked as per the repair instructions before every fill. Individual components of the exhaust aftertreatment system already react very sensitively with even the smallest traces of contaminants in AdBlue®. When handling AdBlue® it is important, therefore, to always use clean containers and collecting bowls which are only reserved for this purpose. Contaminated AdBlue® must not be used again.

**Handling contaminated materials**

It is essential that AdBlue® does not come into contact with materials used in the interior of the vehicle. AdBlue® exposed to air passes within just a few hours from a liquid state into the crystalline state and can therefore damage and destroy contaminated surfaces.

Textiles, e.g. the reversible mat in the luggage compartment, which have been fouled with AdBlue® should be alternately cleaned and then rinsed with water several times.

It must be ensured that there are no further traces of AdBlue® in the textiles.

**Handling contaminated tools**

All tools coming into contact with AdBlue® must be thoroughly cleaned with water immediately after use!

Only fully dried measuring instruments and filling tools should be used so as not to dilute the AdBlue® concentration.

**Protecting components when working with AdBlue®**

AdBlue® leads to corrosion on electronic components and strong fouling on all other materials. It is therefore necessary to cover up all components in the vicinity over the whole surface with plastic foil when working in circumstances where AdBlue® could leak out.

**Storage and packaging**

Storage at temperatures between 0°C/32°F and 25°C/77°F should be ensured in order to avoid crystallization occurring



## Notes on use, material properties and handling of AdBlue®

in AdBlue®. To avoid deterioration in quality due to contamination, AdBlue® must only be handled in storage and filling systems intended exclusively for AdBlue®. Suitable container materials are alloyed steel, various plastics and plastic coatings in metal containers.

Not to be used are unalloyed steel, aluminum, copper, copper-containing alloys and zinc-dipped steel.

---

### Service life and durability

AdBlue® breaks down during storage into ammonium hydroxide and carbon dioxide and then no longer fulfills the requirements of standard ISO 22241.

If the recommended storage temperature of a maximum of 25°C/77°F is maintained, the AdBlue® will fulfill the requirements of this standard for at least 18 months after manufacture. If this recommended storage temperature is exceeded then this period is reduced. Duration of storage and the temperatures to be used are given as guideline values at the end of the document. At temperatures below -11°C/12 °F, the AdBlue® freezes and becomes solid.

On warming up again the frozen AdBlue® becomes liquid again and can be reused without any loss of quality.

The maximum permissible service life of AdBlue® can be taken from the **MB Specifications for Operating Fluids**.

### Disposal and degradability

Disposal of AdBlue®:

When disposing of AdBlue® the legal requirements of the country in which the AdBlue® is used must be observed.

Contaminated packaging/materials:

Packaging which contains residues of AdBlue® is to be handled like the substance itself. Packaging should be emptied as well as possible; it can then be reused after appropriate cleaning with water.

---

### Constant ambient conditions

Storage temperature in °C/°F - Durability in months

≤10 / 50 - 36

≤25 / 77 - 18

≤30 / 86 - 12

≤35 / 95 - 6

>35 / 95 - --

## Information on preventing damage to electronic components due to electrostatic discharge

	Information on preventing damage to electronic components due to electrostatic discharge		Topical note
--	--	--	--------------

**Electrostatic charge**

Every contact and every physical separation of materials or every movement of solids, liquids or charged particle-containing gases can generate electrostatic charge. Plastics generally produce the highest electrostatic charge.

We come across electrostatic charge or discharge in lots of everyday situations, e.g. with:

- Combs
- Walking on carpets or plastic floors
- Putting on and taking off textiles with synthetic fiber content
- Disembarking from the vehicle
- Contact between various electrostatically chargeable packaging materials in shelves or in the transport container

The resulting electrostatic discharge (**Electrostatic Discharge (ESD)**) can be so strong that a small electric shock is detected. Even the smallest discharges which people cannot detect can cause lasting damage to electronic components and control units.

**Effects and consequences of ESD**

Electronic components and control units are very sensitive to ESD. The damage is often not immediately obvious, but becomes apparent some time later. In order to avoid failures and damage due to ESD in vehicle electronics, various procedures and safety precautions must be taken into account and followed.

Risk of damage arises during the transportation, handling, testing, removal and installation of electronic components during production and repair work.

The following electronic components listed as an example can be damaged by ESD:

- Airbag components
- Control units, in particular their bus connections  
Controller Area Network (data bus/CAN bus) (CAN),  
Local Interconnect Network (LIN) etc.
- Sensors
- Mechatronic component parts (actuators etc.)
- Antenna amplifier
- Receivers and displays (Radio, TV, GPS, telephone etc.)

**Modes of behavior and safety precautions**

- Electrostatic discharge of the technician (e.g. by briefly touching the vehicle body).
- Suitable clothing, e.g. made of cotton.
- Wear ESD safety shoes with conductive soles.
- Keep workplace clean and clear away unnecessary objects such as conventional plastics.
- Special antistatic seat cushion protectors should be used when performing repair work inside a vehicle.
- Leave replacement parts in the original packing for as long as possible, do not tear open seals but cut them open carefully.
- The ESD workplace must conform to the ESD guidelines.

- The operation-specific documentation in the WIS must be observed and the specified special tools and/or workshop equipment must be used in each case.
- Before unpacking, discharge ESD protective packaging at the ESD workplace.
- Avoid any contact with electrostatic chargeable materials such as, e.g. polyethylene, PVC, styrofoam.
- Use only original packaging or specially labeled and defined packaging and transport materials.
- Electronic components which have been removed must be put down on an ESD workplace.
- Electrical connectors on electronic component parts and in the wiring harness should be touched by their housing only. Do not touch pins or contacts!
- Electronic components must be installed before they are connected so that potential equalization with the body can take place.
- Shelves and worktables must stand directly on the floor, there must not be any insulating materials between the base of the shelves/feet and the floor. If the above mentioned insulators cannot be removed, the shelves and work tables must be grounded (e.g. low-resistance electrical connection/line from metal shelf to a coolant pipe).
- Do not put down conductive containers/crates when insulated,  
(e.g. on a wooden pallet), as otherwise potential equalization will not take place.



## Information on preventing damage to electronic components due to electrostatic discharge

- Do not place control units and electronic components removed from the vehicle on electrostatically chargeable materials, such as PE, PVC, styrofoam. The

electrostatic charge is transferred to the control unit or electronic component. An ESD service kit or a connected ESD table mat must be used.

---

### **Training**

It is strongly recommended that every company has an ESD officer trained in accordance with DIN EN 61340-5-1.

The ESD officer can carry out staff training courses.

The aim of the training measures is to communicate the main problems and effects of ESD to staff:

- Discharge generation
- Reasoning for safety precautions
- Effects and consequences of ESD
- ESD rules of conduct and safety precautions

### **Return of electronic components in warranty and goodwill cases**

When returning electronic components it is absolutely essential to observe the procedure and safety precautions listed. The original fault may be falsified or hidden by electrostatic charge/discharge.

This can lead to distorted fault symptoms in the case of the fault analysis of the component concerned.



Notes on carrying out repair work in the vehicle interior

	Notes on carrying out repair work in the vehicle interior		Topical note
--	---	--	--------------

**In order to prevent soiling or damage, the following information must be observed:**

- Before starting repairs in the vehicle interior, the corresponding protective covers must be provided in the repair area for the floor coverings, seats, steering wheel, etc. to prevent them from becoming dirty.
- Persons performing work in the vehicle interior should ensure they have clean work clothes, clean shoes and clean hands.
- When removing bulky or difficult to handle parts (e.g. bench seat, roof lining, instrument panel etc.), always work with aid of at least a second person.
- Do not use dirty or unapproved tools. This prevents any, e.g. scratching or crazing of interior parts etc.
- Always place removed interior parts on a clean and soft surface.

**Further information:**

- Repair or replace damaged interior parts (particularly mounts such as retaining clips, Velcro fasteners etc.).
- When installing interior parts at the intended locations, install insulation material and/or protective foils, or, replace insulation material/protective foils as required in order to dampen vibrations and noise.
- Many equipment parts in the area of the vehicle interior have been installed or made specifically to the customer's request, and cannot be replaced easily if damaged or soiled; for this reason, utmost care must be ensured when carrying out operations in the vehicle interior.
- Remove any dirt present with cleaners approved by Daimler and suitable for corresponding surfaces. When doing so, where possible, the compatibility of the cleaning agent should be tested at a concealed area of the part to be cleaned.



## Lift point locations



When performing procedure on a vehicle lift



Vehicle must be in a ready to lift position before procedure is started.



Read the operating instructions for the vehicle lift.

### Lift mounting points on the vehicle in the area of the front axle

- 01 spring clamp plate
- 02 longitudinal member
- 08 bracket
- 011 arm of hydraulic lift
- 012 support plate
- 013 long support plate
- 017 support drift

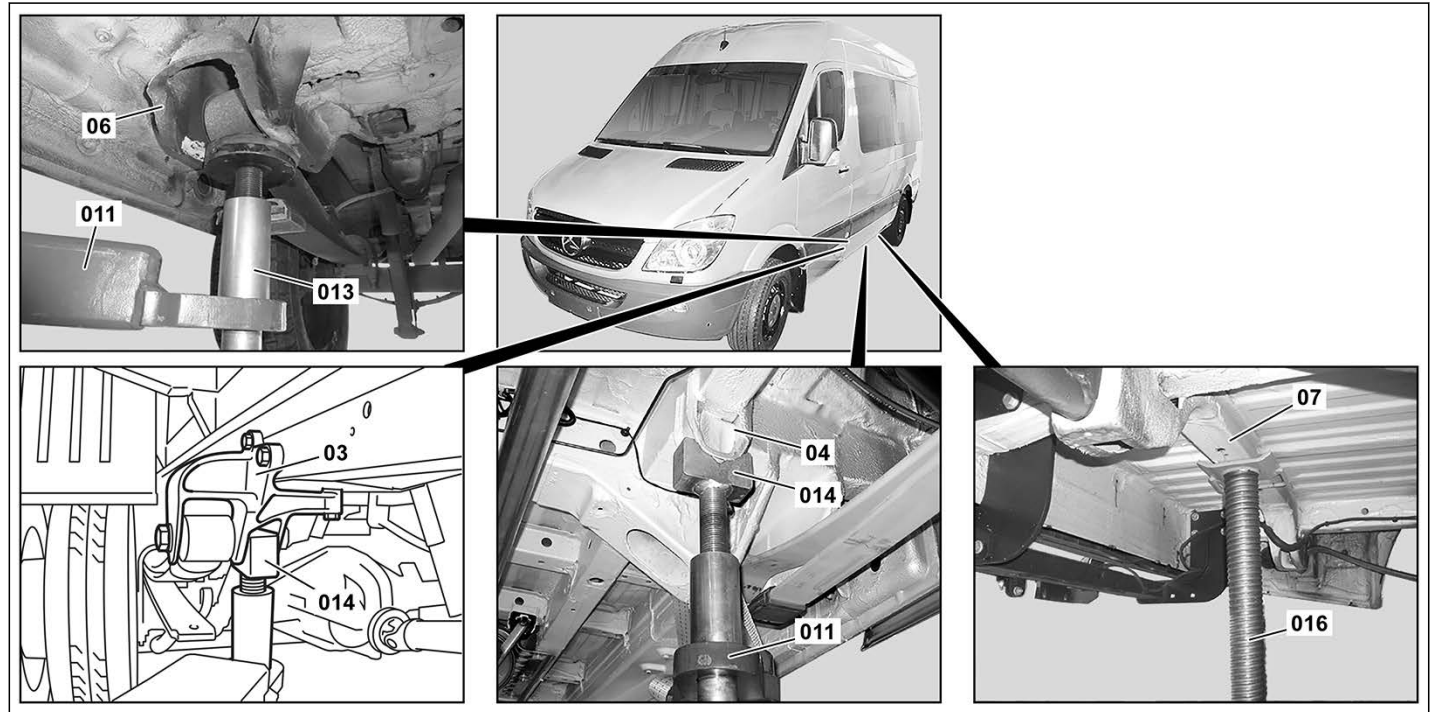
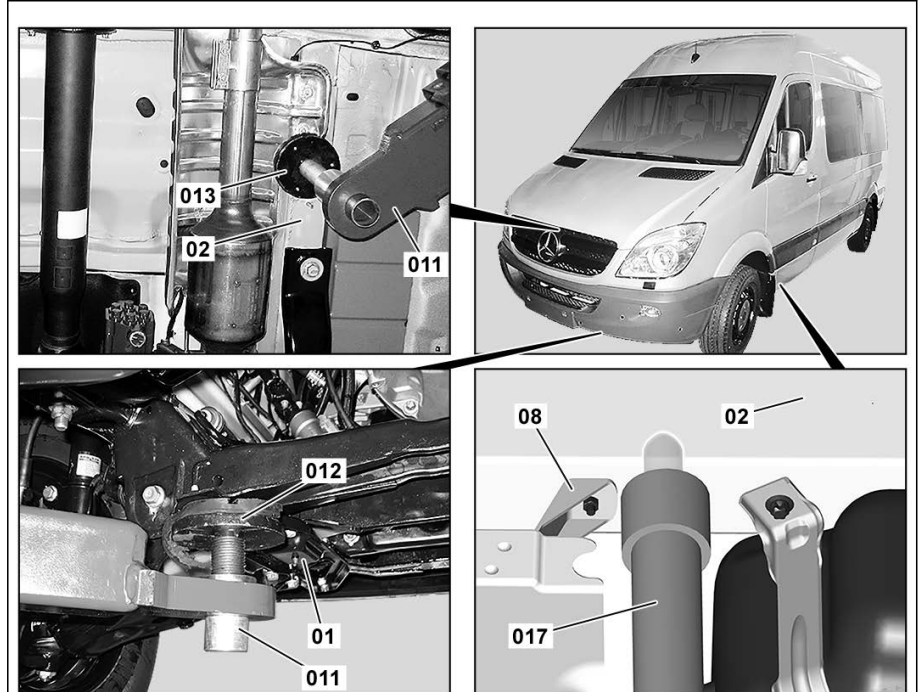

### Lift mounting points on the vehicle in the area of the rear axle

- |                              |                           |             |
|------------------------------|---------------------------|-------------|
| 03 front rear spring bracket | 07 crossmember            | 014 v-block |
| 04 longitudinal member       | 011 arm of hydraulic lift | 016 prop    |
| 06 front rear spring bracket | 013 long support plate    |             |





Picture reference	Pick-up point	Information
03	Support at rear to front rear spring bracket.	
04	Rear support at longitudinal member.	- If possible, always support at rear Install at longitudinal member (4).
06	Install on front rear spring bracket.	
012	Support plate.	- For front support to spring clamp plate (1). Unscrew support plate (012) at right and left an equal distance. - In vehicles with vehicle lift support point at integral carrier (5).
013	Long support plate.	- For front support at longitudinal member (2) and support at front rear spring bracket (6). Can be used alternatively to front support to spring clamp plate (1). Pull out long support plates (013) at right and left an equal distance. - In vehicles without a vehicle lift support point at the integral carrier (5) in the vicinity of the inner mounts of the semi-trailing arms.
014	V-block	- For rear support at front rear spring bracket (3) and rear support at longitudinal member (4). Pull v-block (014) at right and left rear out an equal distance.
016	Ram	- Vehicles with heavy bodies and panel vans/crewbuses with a long wheelbase at the crossmember (7) should be supported with a prop (016).
017	Support drift	- With soundproofing Ensure that support drift (017) does not make contact with bracket (8) of rear soundproofing. If necessary, loosen bracket (8), push towards the front as far as possible and retighten it. Otherwise the brackets (8) of the rear soundproofing and the longitudinal members may be damaged. - For front support to longitudinal member (2). Unscrew support drift (017) at right and left an equal distance.

**Secure vehicle on lift.**

**Heavily loaded vehicles, vehicles with a heavy body and vehicles with unfavorable load distribution must be secured.**

**Otherwise these may fall.**

## Instructions for driving onto ramps



When performing procedure on ramps.



**Vehicle must be driven onto ramps before procedure is started, and may remain on ramps for the entire procedure.**



**Race Ramps are available for order from MBUSA Standard Service Equipment Program (SSEP): [www.mbusassep.com](http://www.mbusassep.com)  
Part number:  
784-RR-HTVR-RC-KIT**



Read the operating instructions provided by the manufacturer of the ramps. Since these are ramps that have not been built or tested by Mercedes Benz, no information can be given on safety. Mercedes Benz excludes all liability when using these ramps.

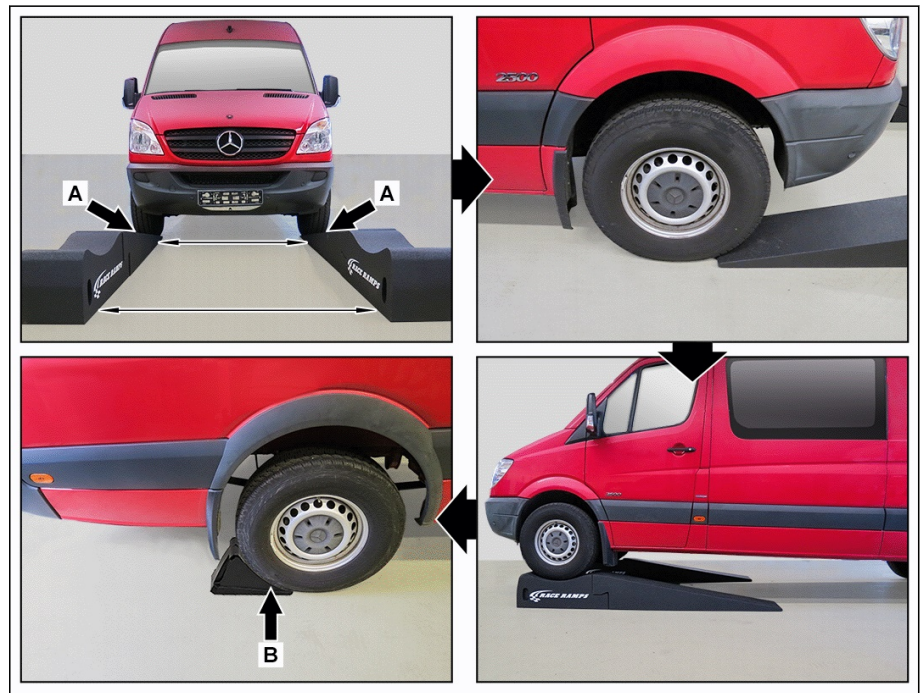

- 1 Place the vehicle on a clean, firm and level surface.



Make sure that there is enough space to the front.

- 2 Place ramps in the middle (arrows A) of the front wheels.



The ramps must be aligned parallel to each other.

- 3 Drive the vehicle onto the ramps until it is positioned in the end position specified by the manufacturer of the ramps.



**Drive the vehicle slowly and at a constant speed onto the ramps.**

**Otherwise the vehicle may be damaged.**



If necessary, include a helper to instruct you.

- 4 Secure the vehicle against rolling away.



For example, by applying the parking brake and by placing a wheel chock (arrow B) on the rear wheels.

## Initial Quick Test

- 1 Switch off the ignition.
- 2 Disconnect Geotab, Omni Track, Navigation or any aftermarket devices that are connected to the X11/4 diagnostic socket.

- 3 Open the hood.



**Verify Vehicle Identification Number (VIN) on vehicle VIN markings matches VIN on Repair Order exactly. Correct VIN errors on RO before RO is closed at your dealership.**

- 4 Connect the battery charger to the vehicle's jump posts as indicated. (arrows)



**A sufficient power supply to the vehicle on-board system must be ensured throughout the entire work procedure.**

**Otherwise any undervoltage that occurs may damage the control units.**



Do not connect the battery charger to the auxiliary battery in the engine compartment.



Follow the operating instructions for the battery charger.







Use a Mercedes-Benz recommended battery charger to ensure an adequate voltage supply (min. 12.5 V) is provided for the on-board electrical system battery.

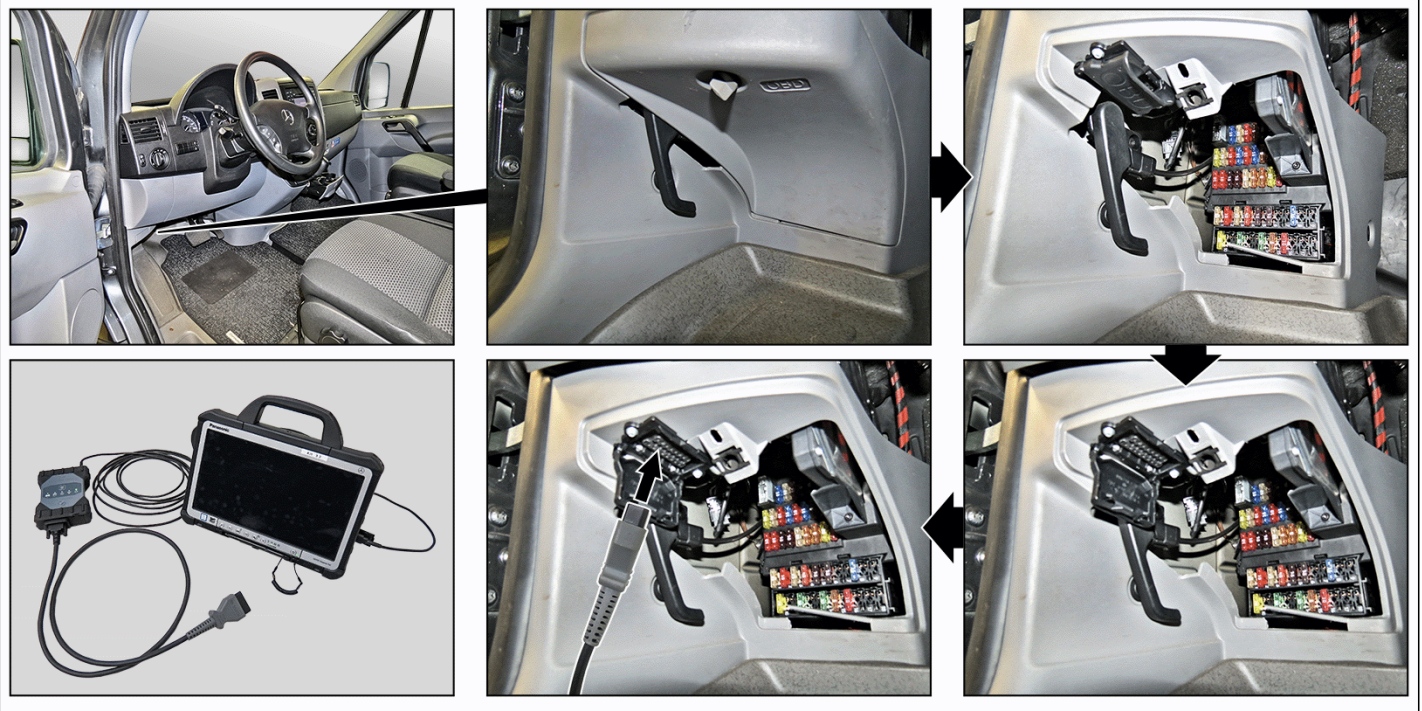





- 5 Ensure XENTRY is fully updated with the latest release and all available add-ons.
- 6 Connect the diagnostic system. Make sure that the OBD2 connection cable is connected directly to the factory X11 / 4 diagnostic socket and not via an adapter cable.
- 7 Switch on the ignition.  
 The diagnostic system remains connected to the vehicle throughout the work procedure! Do not disconnect the diagnostic system's online connection.
- 8 Start the diagnostic system.
- 9 Run XENTRY and perform Quick Test. Upload Initial Quick Test print-out to paperless pXD.  
 **Ensure Vehicle Identification Number (VIN) readout in XENTRY/DAS matches vehicle VIN markings exactly. If not, please open a PTSS case with photos of VIN markings and XENTRY/DAS Quick Test showing VIN readout.**  
 Pre-existing faults causing a Check Engine Light must be evaluated. Reference Pre-Inspection Notes on page 2.  
 The procedure via the diagnostic system is shown on the following pages.
- 10 Perform Emissions Modification Pre-Inspection.

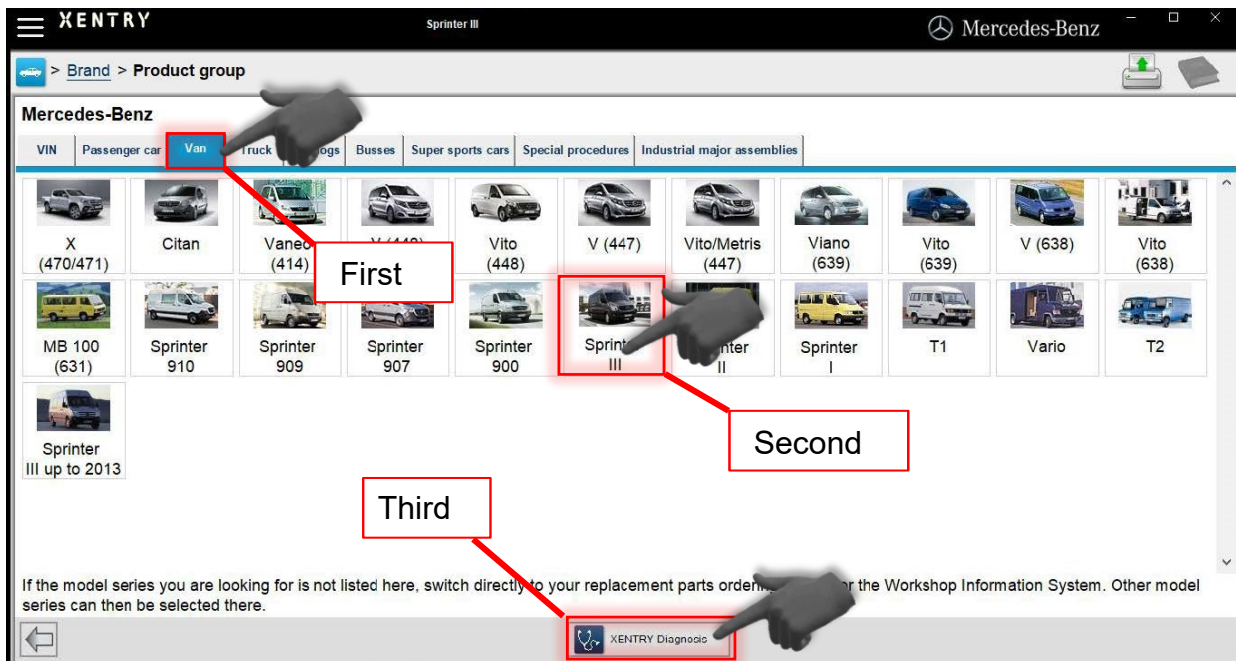



The screenshot shows the XENTRY software interface. At the top, it says 'Sprinter III' and 'Mercedes-Benz'. Below the header, there is a breadcrumb trail: '> Brand > Product group > Vehicle'. The main area is titled 'Model' and contains the instruction: 'Please select a vehicle model designation from product group 'Sprinter III''. Below this, there is an information icon and the text: 'You can now start XENTRY Diagnosis or select more vehicle data for other applications.' A list of vehicle models is displayed, including various CDI FHS and FHL models with their respective specifications. At the bottom of the list, there is a button labeled 'XENTRY Diagnosis' which is highlighted with a red box and a hand icon pointing to it. To the right of this button is a 'Continue' button.

The screenshot shows the XENTRY Diagnosis software interface. At the top, it says 'Sprinter III' and 'Mercedes-Benz'. Below the header, there is a breadcrumb trail: '> Diagnosis'. The main area is titled 'The diagnosis application is being started ...' and shows 'Progress (step 1 of 4):'. A progress bar is visible, and a list of status items is shown: 'The boundary conditions are recorded.', 'The simulation files are being copied ...', 'The control units are being initialized.', and 'Check of VIN'. Below this, there is a section for 'Optional settings:' with several checkboxes: 'Automatically start quick test on completion of vehicle identification.', 'Automatically start and print out quick test on completion of vehicle identification.', 'Automatically start quick test on completion of vehicle identification and print out together with fault freeze frame data.', 'Save quick test as PDF file instead of printing it out.', and 'Do you want to save the setting for future diagnosis sessions?'. A speech bubble with the word 'wait' is overlaid on the screen. At the bottom right, there is a 'Continue' button.

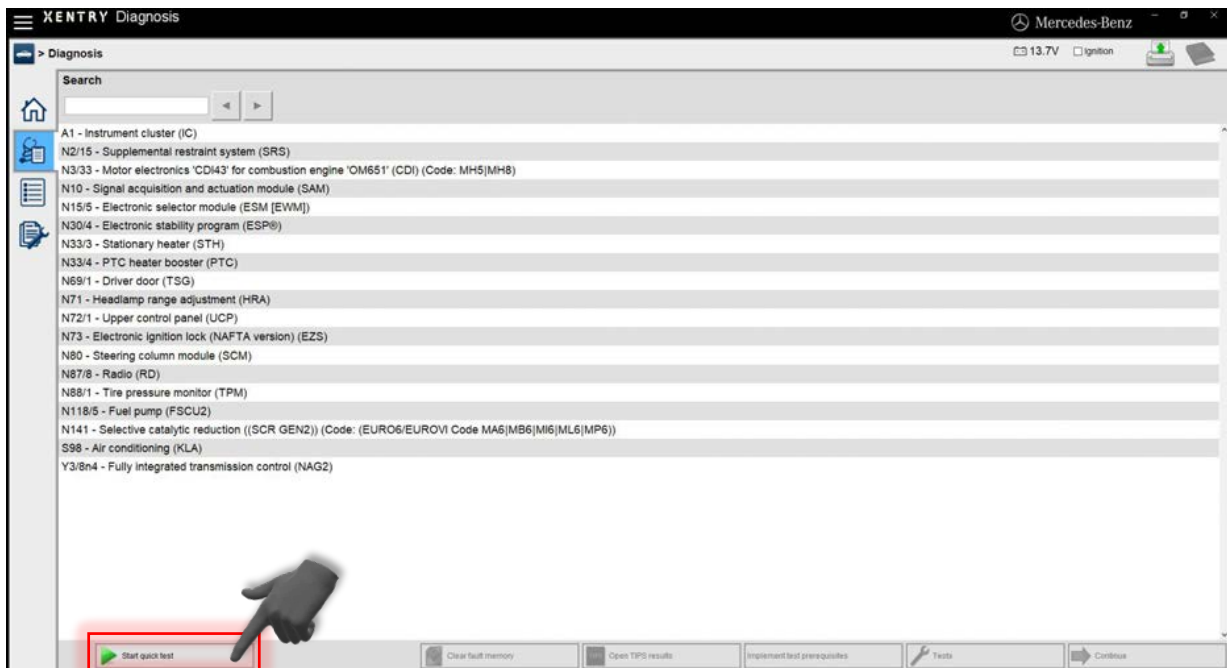
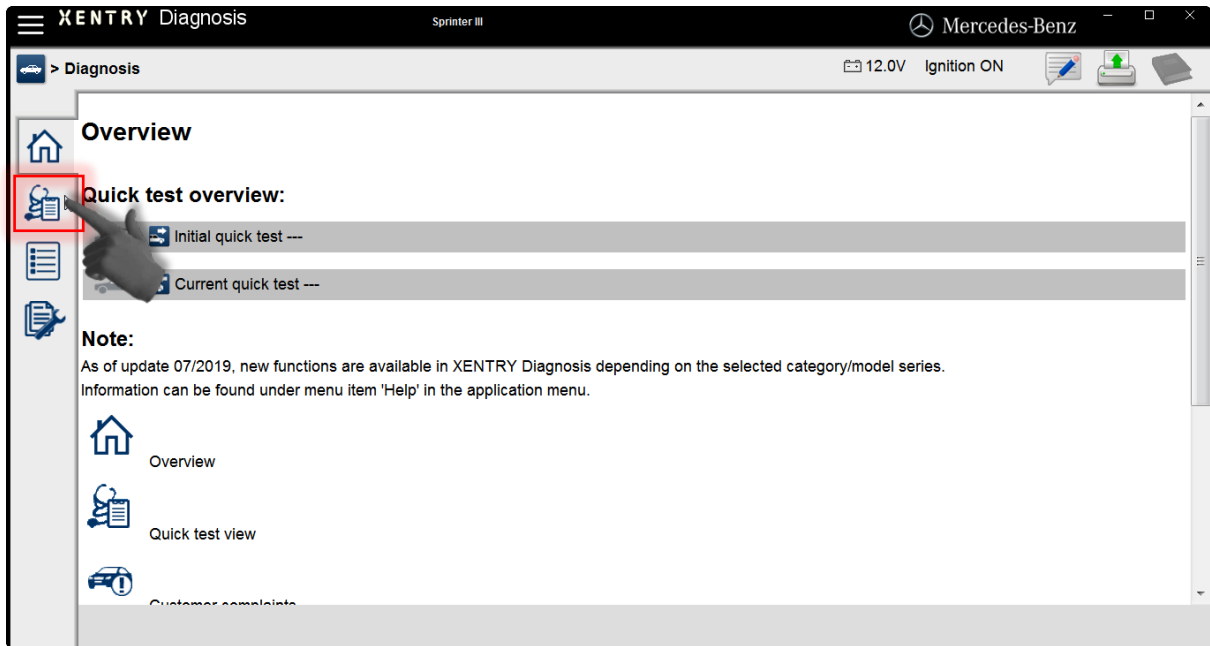



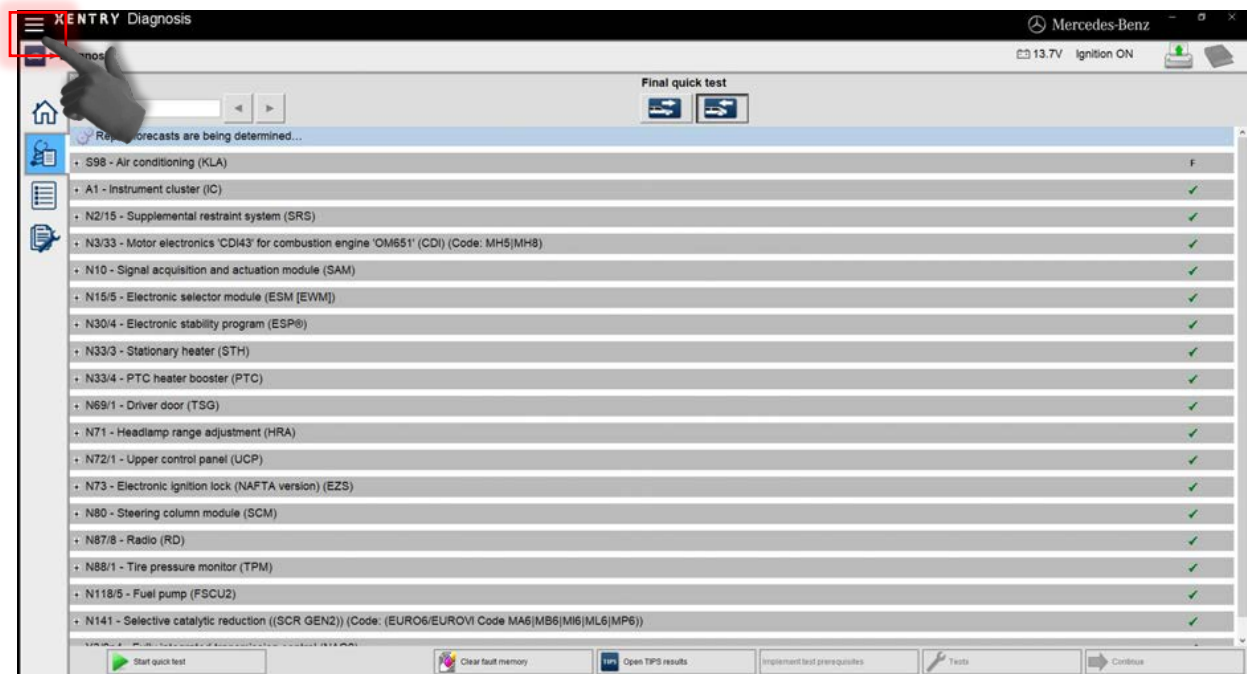
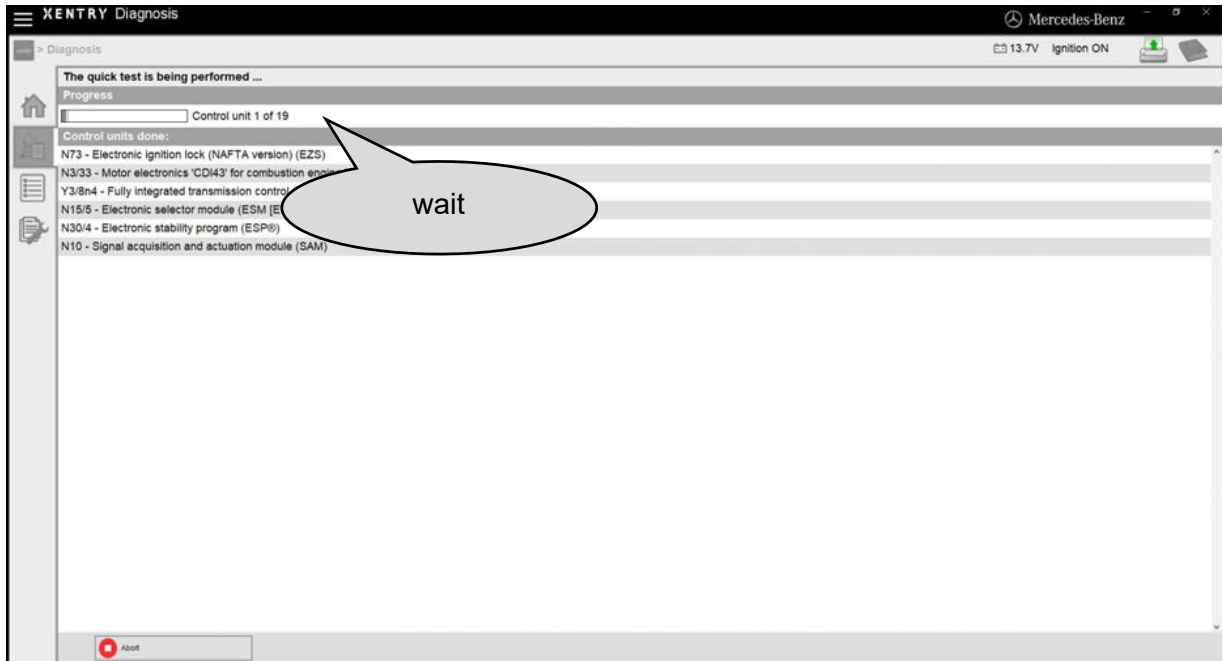



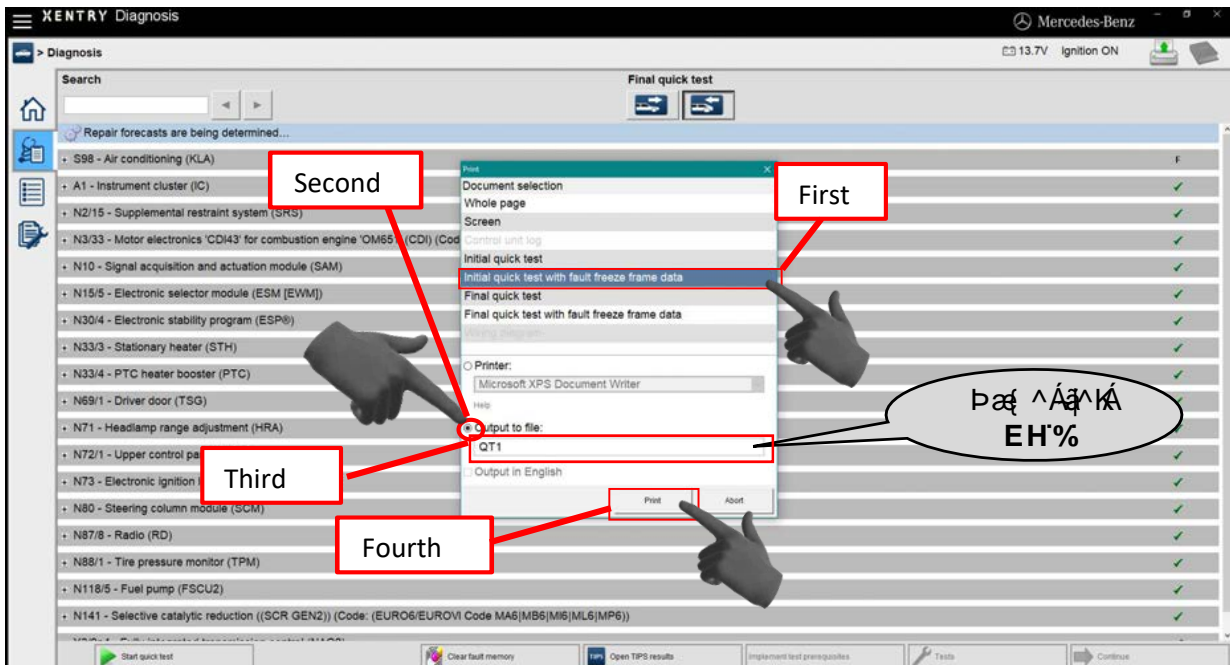
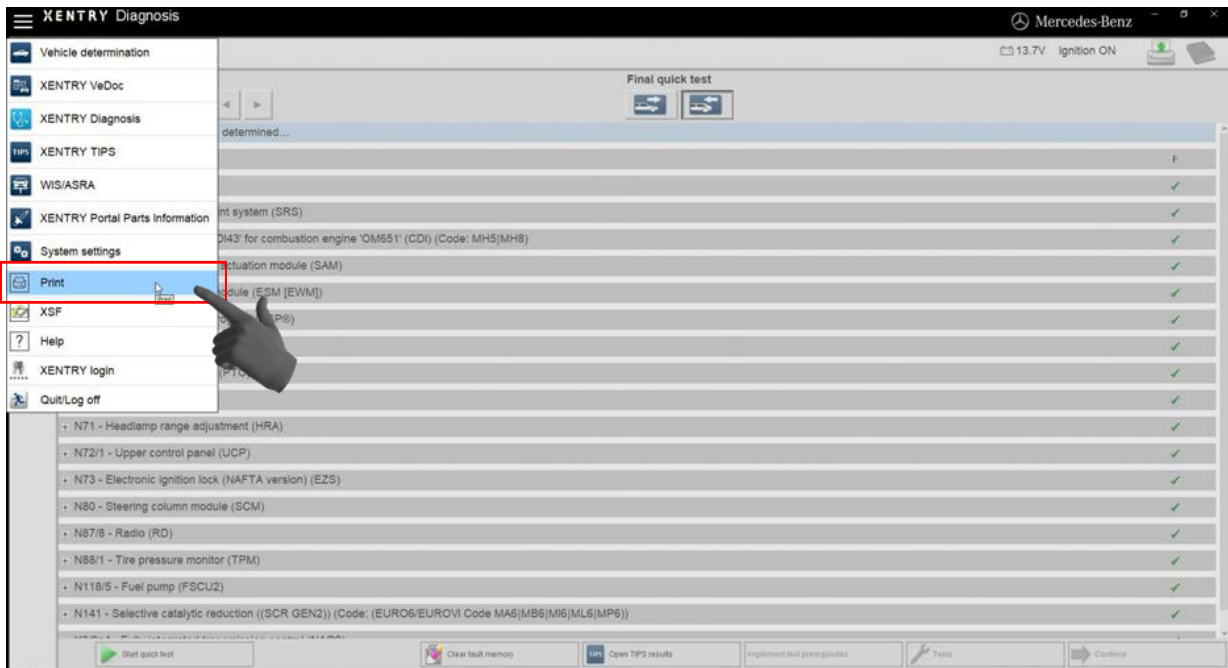

Pre-existing faults causing a Check Engine Light must be evaluated. Reference Pre-Inspection Guide on page 2.



## DfY!-bgdYWjcb Special Procedure

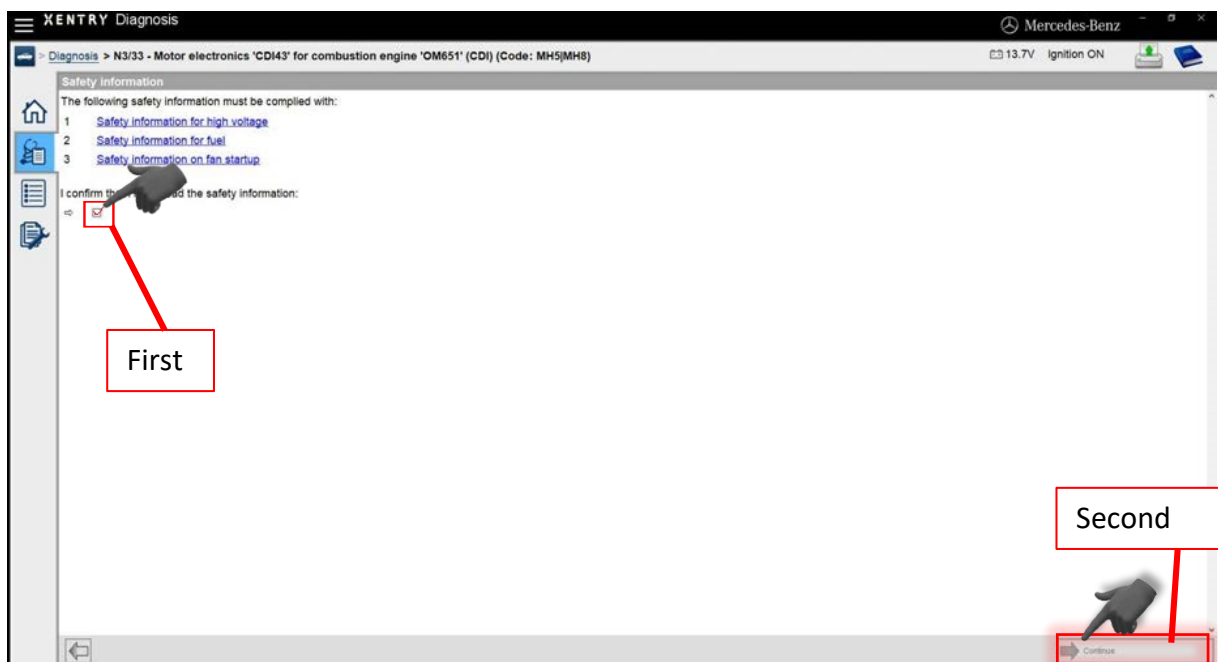
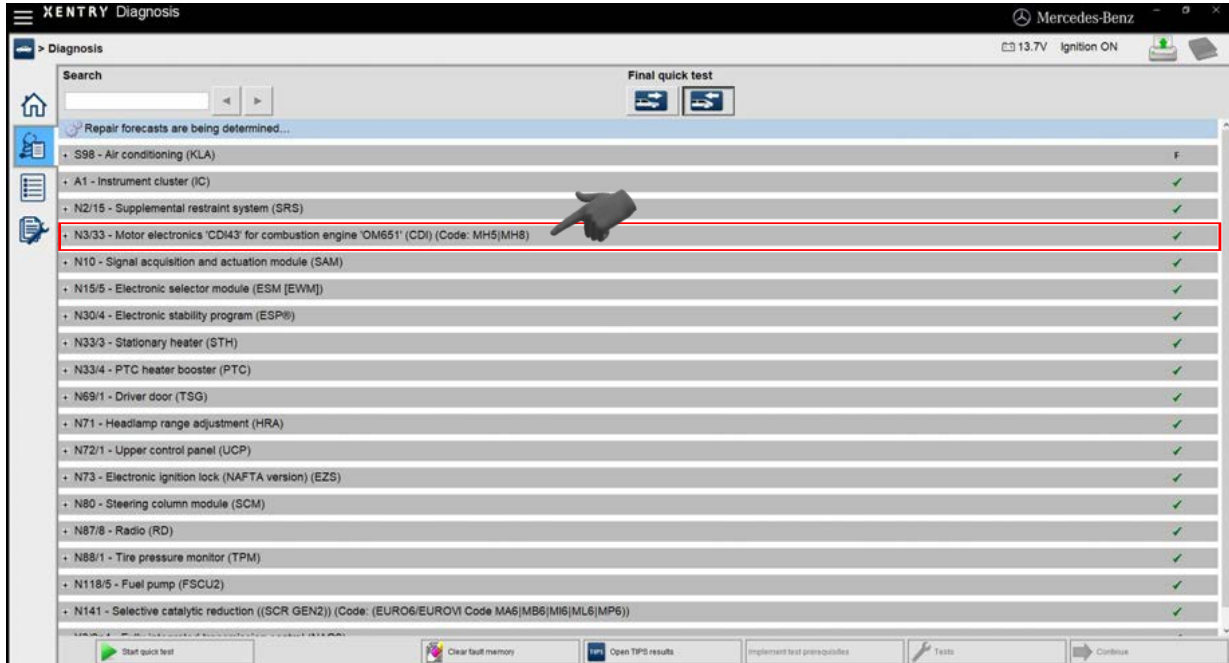

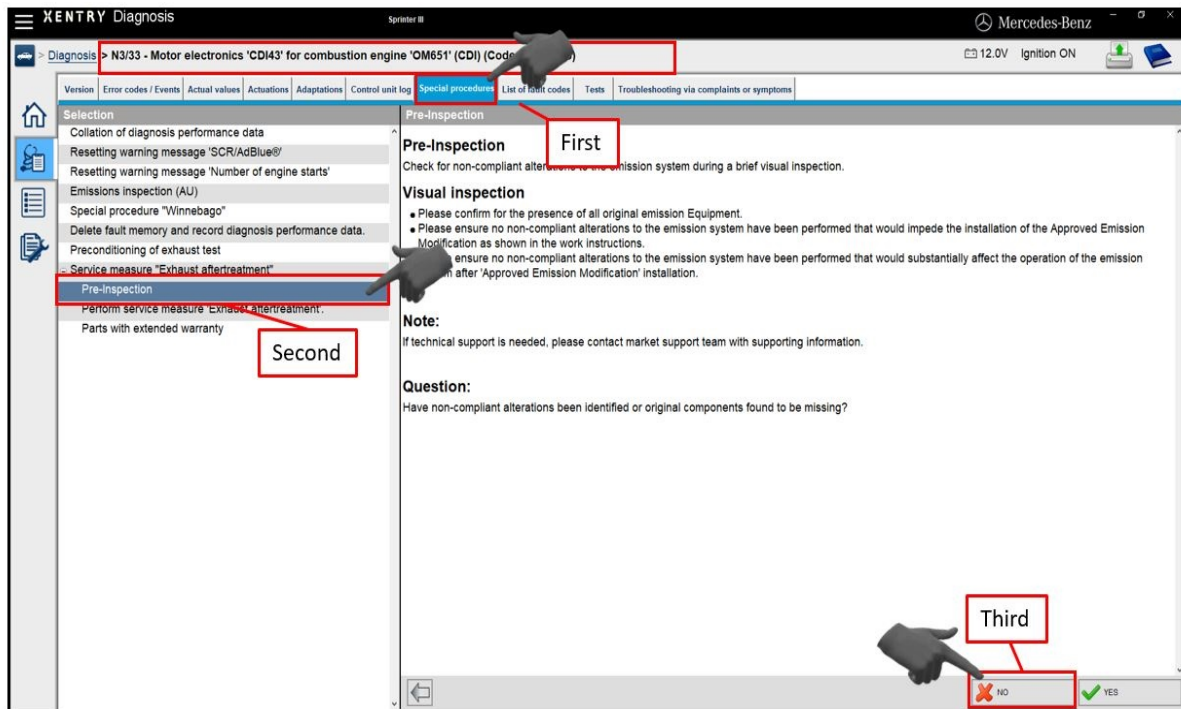

If Non-Compliant alterations are found, reference the Pre-Inspection Guide on page 2 for next steps.

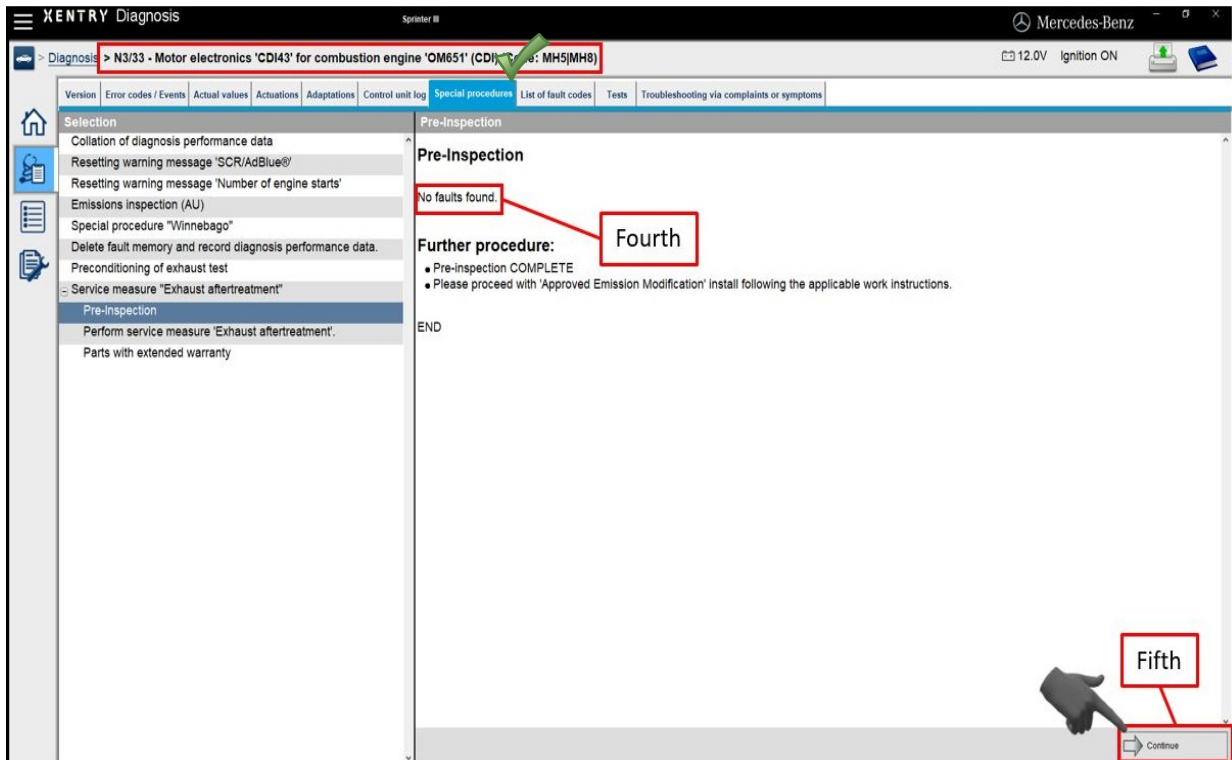

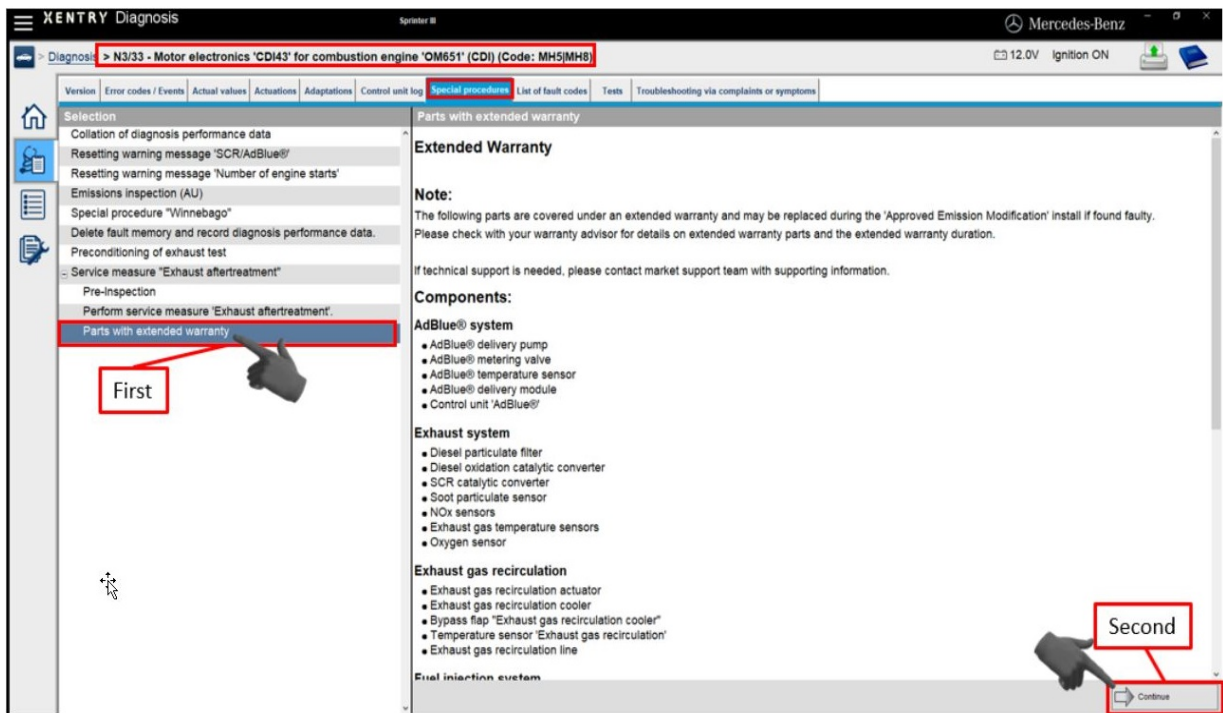

11 End the XENTRY session.

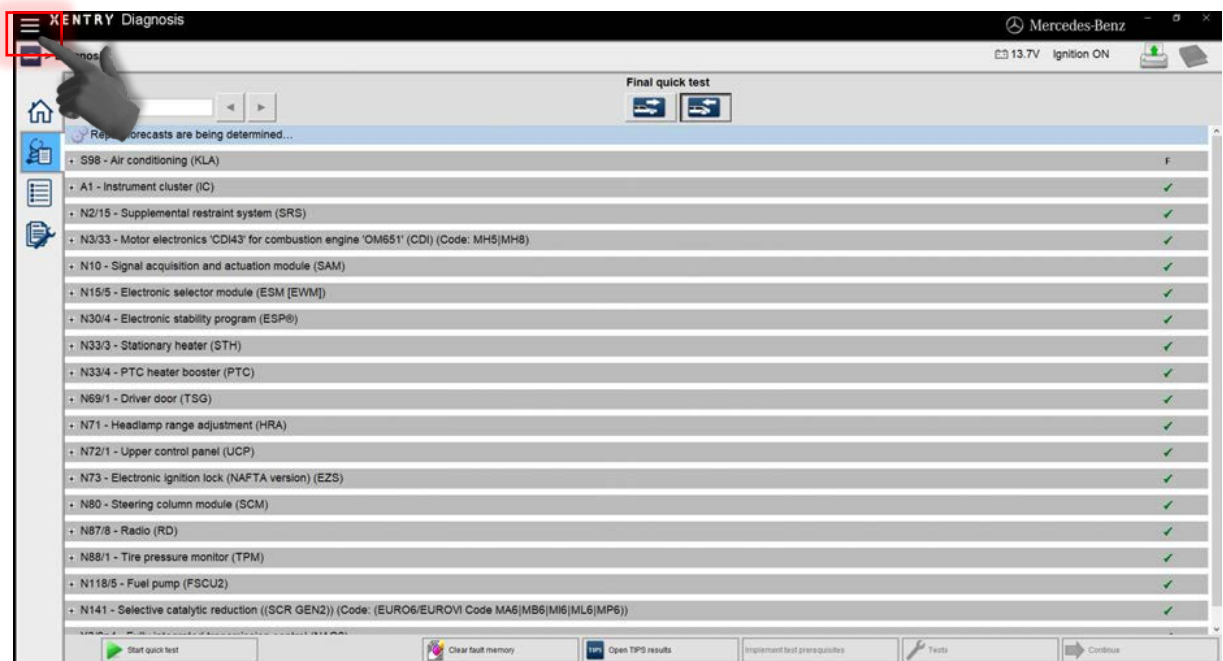

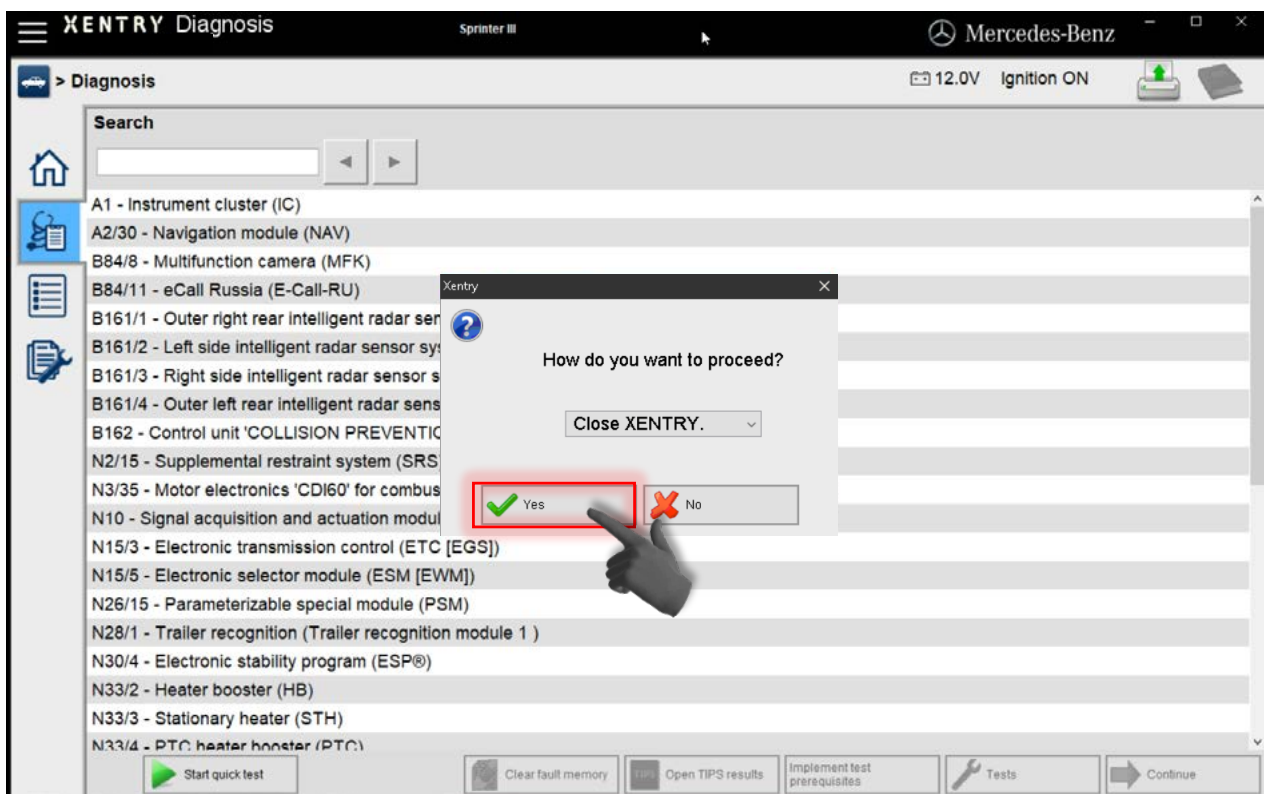
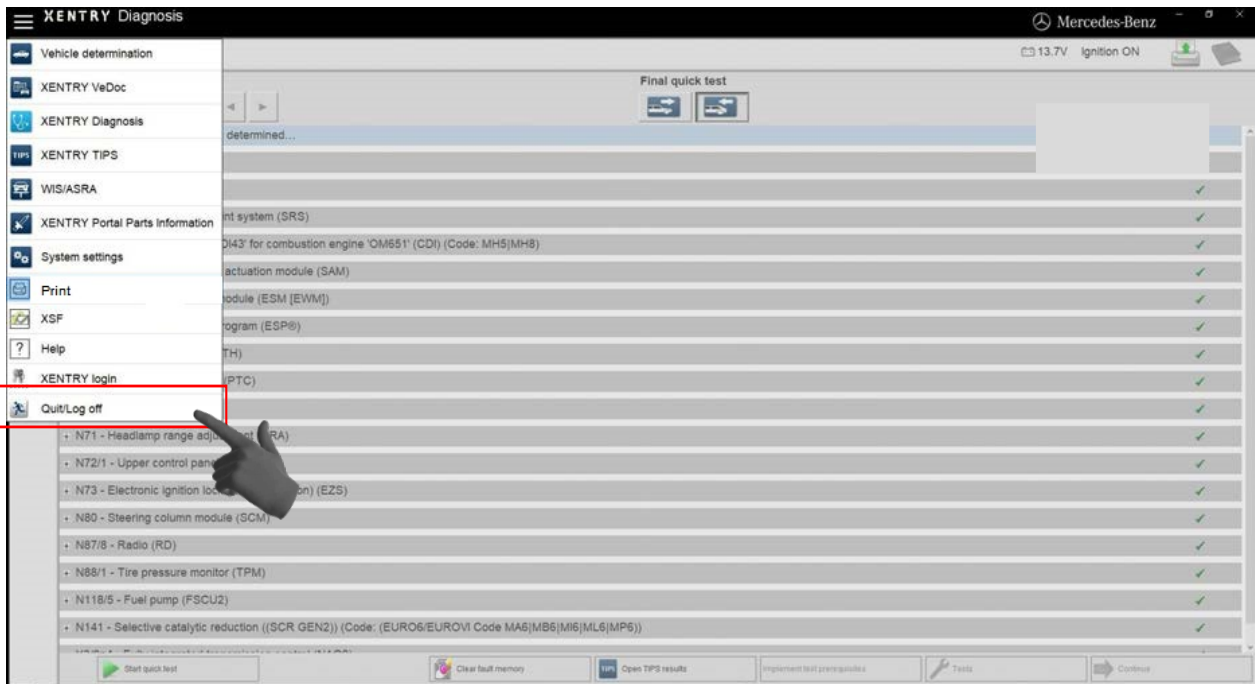

- 12 Switch off the ignition.
- 13 Disconnect the diagnostic system.
- 14 Disconnect battery charger.



## Replacement of AEM Parts

- 15 **Lift:**  
Raise the vehicle.  
**i**  
A description of the lift points is available on pages 19-20.
- Ramps:**  
Vehicle may remain on ramps.

- 16 Spray penetrating oil on the threads of the NO<sub>x</sub> sensor upstream (3) and downstream (5) of SCR catalytic converter, as shown.



**Exhaust system should be cold in order to carry out the next steps. This avoids injuries.**



**Observe the wait period and details provided by the manufacturer of the penetrating oil!**

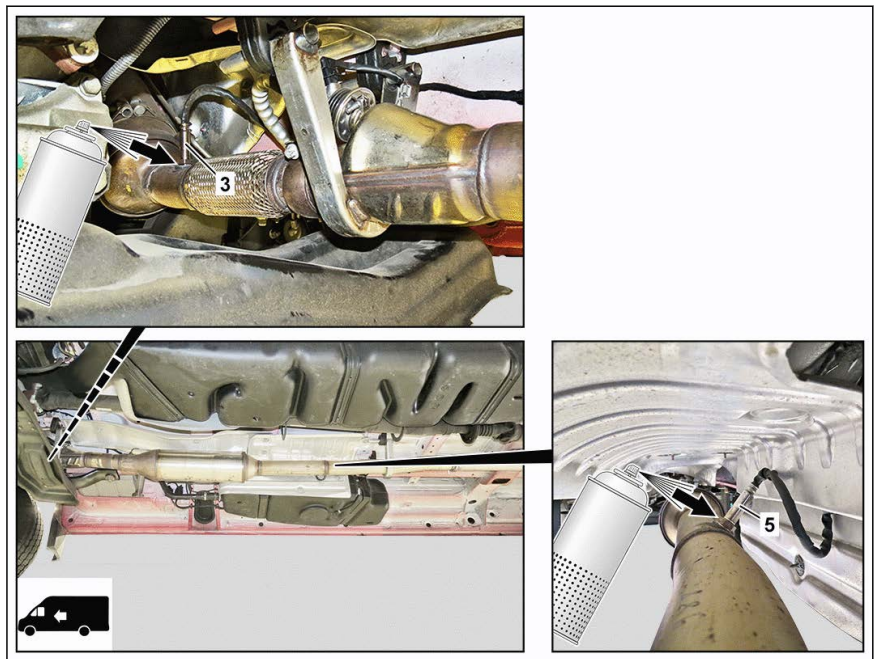

## Removal of Upstream NOx Sensor

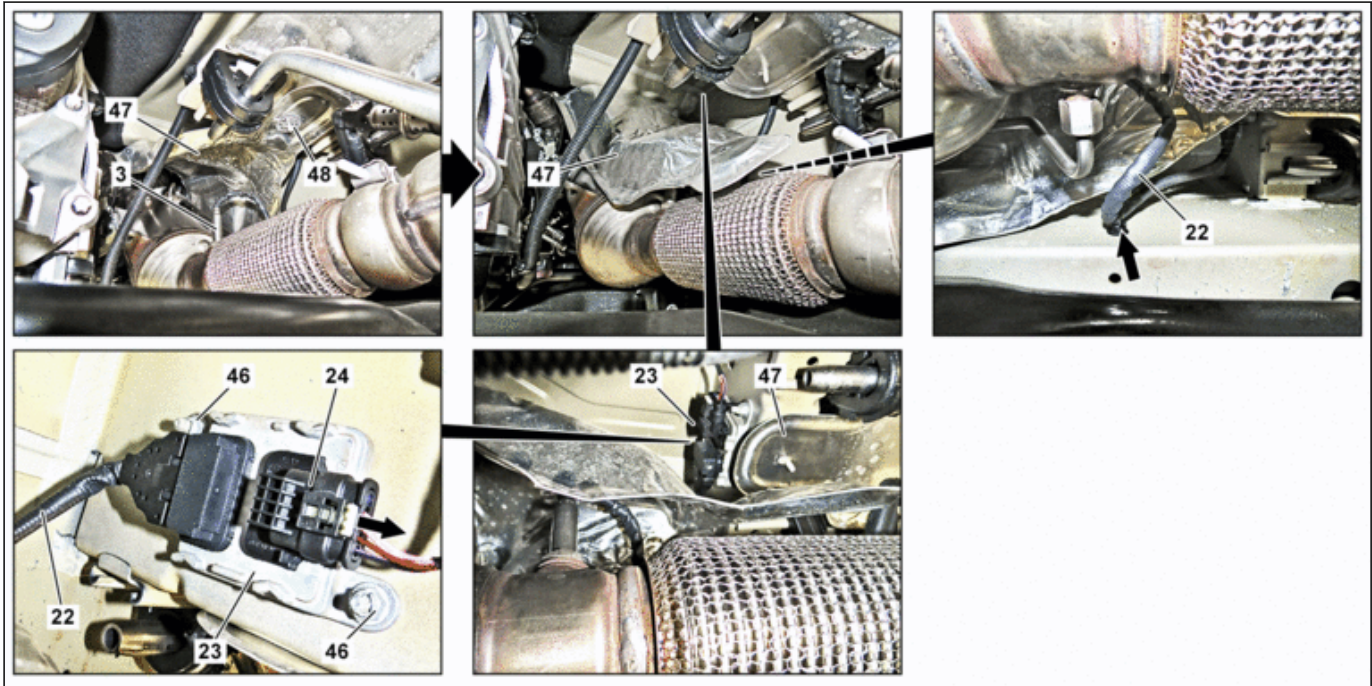

- 17 Loosen the heat shield (47).
- 18 Bend the heat shield (47) down until the NOx sensor control unit upstream of the SCR catalytic converter (23) is accessible.
- 19 Disconnect the electrical plug connection (24) NOx sensor control unit upstream of the SCR catalytic converter (23).
- 20 Remove the NOx sensor control unit upstream of the SCR catalytic converter (23) from the frame.
- 21 Remove and dispose the cable ties and retaining clips (arrows) from harness (22) of the NOx sensor control unit upstream of the SCR catalytic converter (23).
- 22 Remove NOx sensor upstream (3) of the SCR catalytic converter.
- i**  
The control unit and the NO<sub>x</sub> sensor upstream (3) of the SCR catalytic converter are a single unit.
- i**  
Return the NOx sensor upstream of SCR catalytic converter (3) to the originating parts department.
- 23 Clean the threads and the contact surfaces on the exhaust pipe.



This is done by bending up the individual locking fins with a screwdriver and unscrew the clamping nut (48) in a counter-clockwise direction with a screwdriver.



To do this, unlock the gray retaining tab by moving in the direction of the arrow.



To do this, remove and dispose nuts (46)



Observe state-specific regulations for disposal.

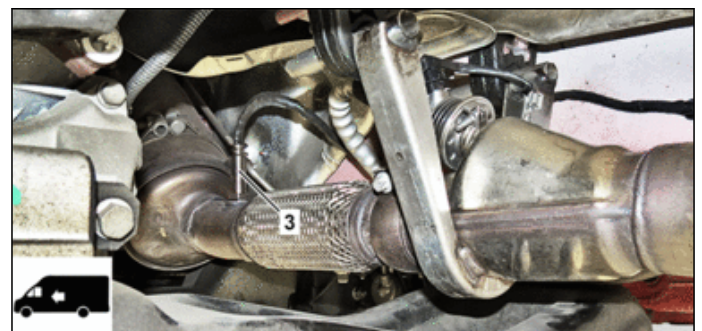



## Removal of Downstream NOx Sensor

- 24 Remove and dispose mounting tab (34) from harness (32).



Observe state-specific regulations for disposal.

- 25 Remove and dispose of the clamping nuts (26).



This is done by bending up the individual locking fins with a screwdriver and unscrew the clamping nuts (26) in a counter-clockwise direction with a screwdriver.

- 26 Remove the heat shield (25).

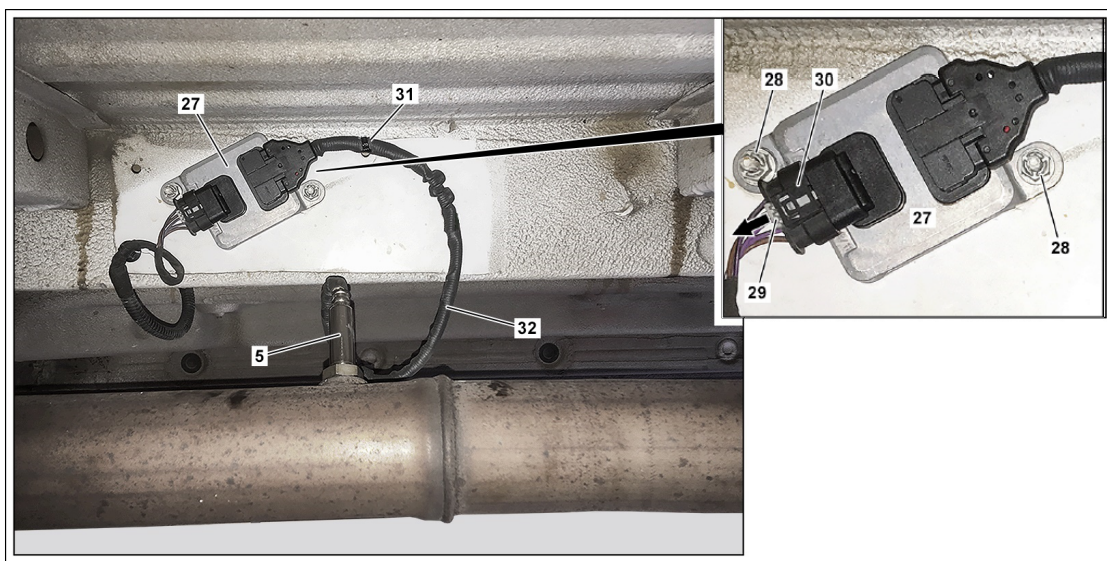
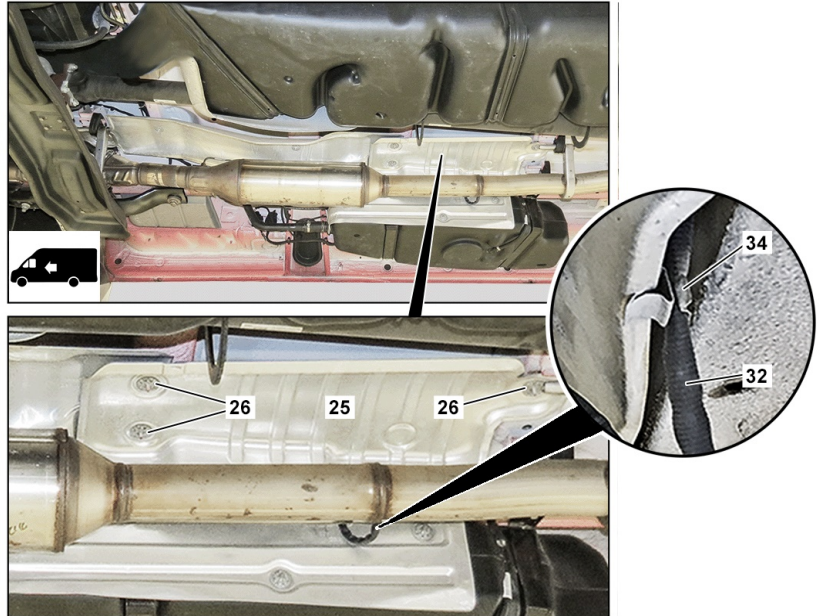

- 27 Disconnect the electrical plug connection (30) at the NO<sub>x</sub> sensor control unit downstream of the SCR catalytic converter (27).



To do this unlock the gray locking device (29) by moving in the direction of the arrow.

- 28 Remove the NO<sub>x</sub> sensor control unit downstream of the SCR catalytic converter (27).



To do this, remove and dispose the nuts (28) and cable tie (31).

- 29 Remove the NO<sub>x</sub> sensor downstream of the SCR catalytic converter (5).



The control unit and the NO<sub>x</sub> sensor downstream of the SCR catalytic converter (5) are a single unit.



Return the NO<sub>x</sub> sensor downstream of the SCR catalytic converter (5) to the originating parts department.





## Installation of Upstream NOx Sensor

- 30 Install new NOx sensor upstream of SCR catalytic converter (3).



**A 000 905 80 11 80**  
(included in package  
A 651 905 10 00 85)

NO<sub>x</sub> sensor upstream of SCR  
catalytic converter: Torque to  
**60 Nm / 44.3 ft·lb**

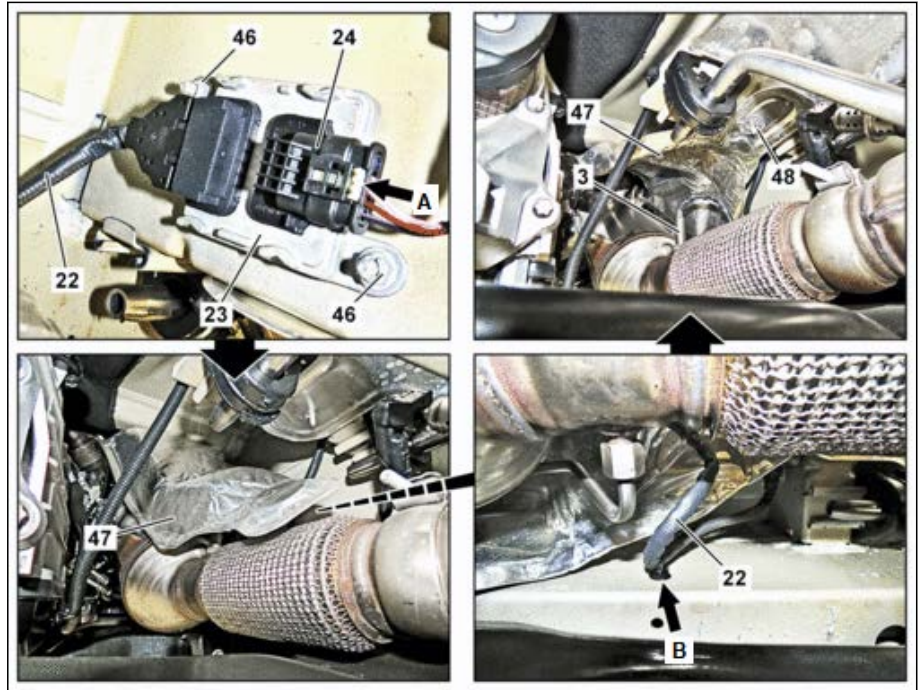

- 31 Install the NO<sub>x</sub> sensor control unit upstream of the SCR catalytic converter (23) on the frame.



Use new nut fasteners (46):  
**N 000000 003477**

NO<sub>x</sub> sensor control unit:  
Torque to **9 Nm / 6.6 ft·lb**

- 32 Connect the electrical plug connection (24).



Push the gray retaining tab  
(24.1) in the direction of  
arrow A to lock.

- 33 Secure the harness (22) with  
a cable tie. (arrow B)



**A 007 997 56 90 (1x)**

- 34 Bend the heat shield (47) back into  
old position and install a new clamping  
nut (48).

**A 000 994 32 11**



To do this, place the clamping nut (48)  
centrally on the pin, as shown, and slide up  
to the stop using a socket wrench.

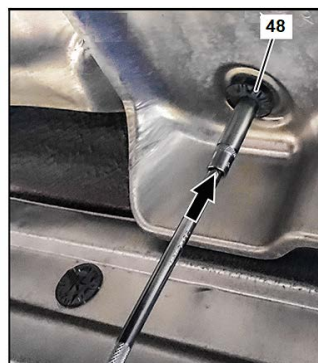

## Installation of Downstream NOx Sensor

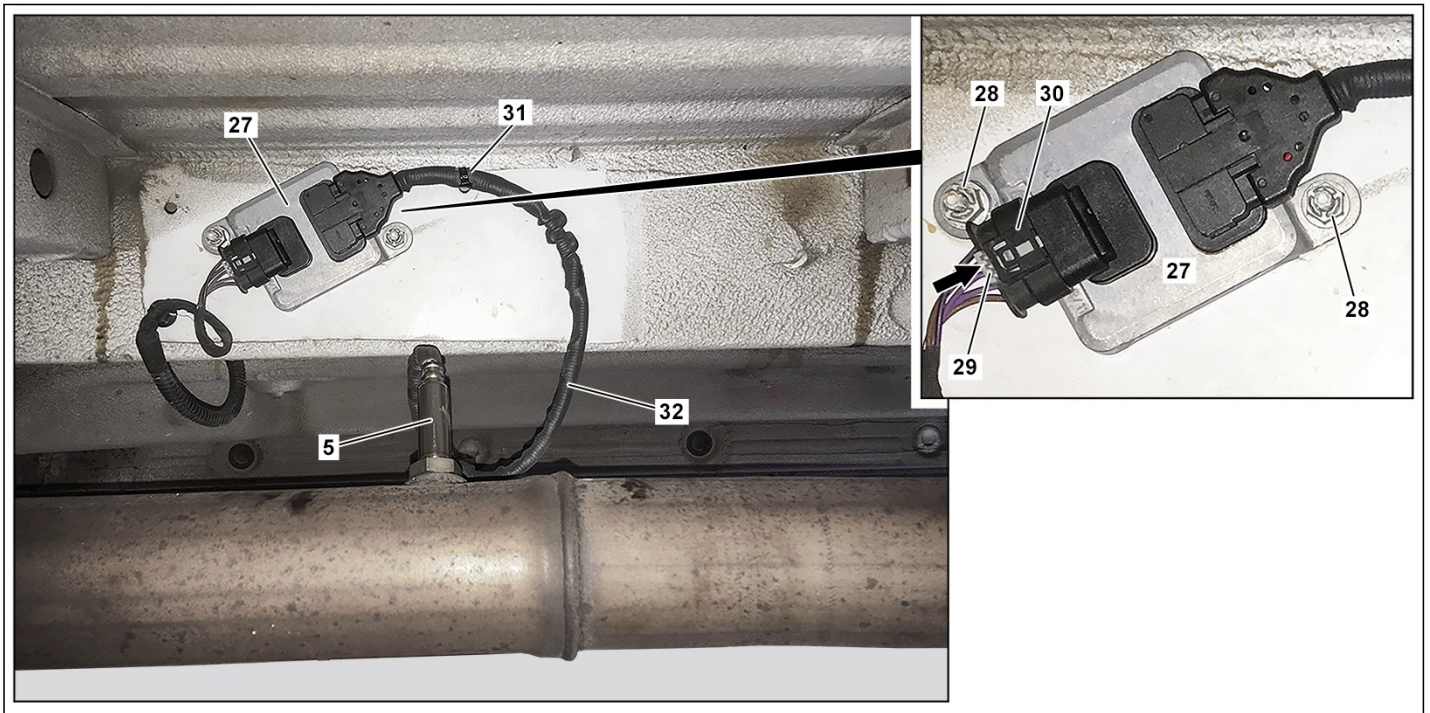

- 35 Install new NOx sensor control unit downstream of the SCR catalytic converter (27).
- i**  
**A 000 905 80 11 80** (included in package A 651 905 10 00 85)  
Use new nut fasteners:  
**N 000000 003477**  
NO<sub>x</sub> sensor control unit: Torque to **9 Nm / 6.6 ft·lb**
- 36 Install the new NO<sub>x</sub> sensor downstream of the SCR catalytic converter (5) on the new SCR catalytic converter.
- i**  
NO<sub>x</sub> sensor downstream of catalytic converter: Torque to **60 Nm / 44.3 ft·lb**
- 37 Connect and lock the electrical plug connection (30).
- i**  
Push the gray locking piece (29) in the direction of the arrow to lock.
- 38 Secure harness (32) with cable tie (31).
- i**  
**A 007 997 56 90 (1x)**
- !**  
Do not route the harness (32) under tension. Otherwise damage could occur.



- 39 Install the heat shield (25).



To do this, place the new clamping nuts (26) centrally on the pin, as shown, and slide up to the stop using a socket wrench.



**A 000 994 32 11**

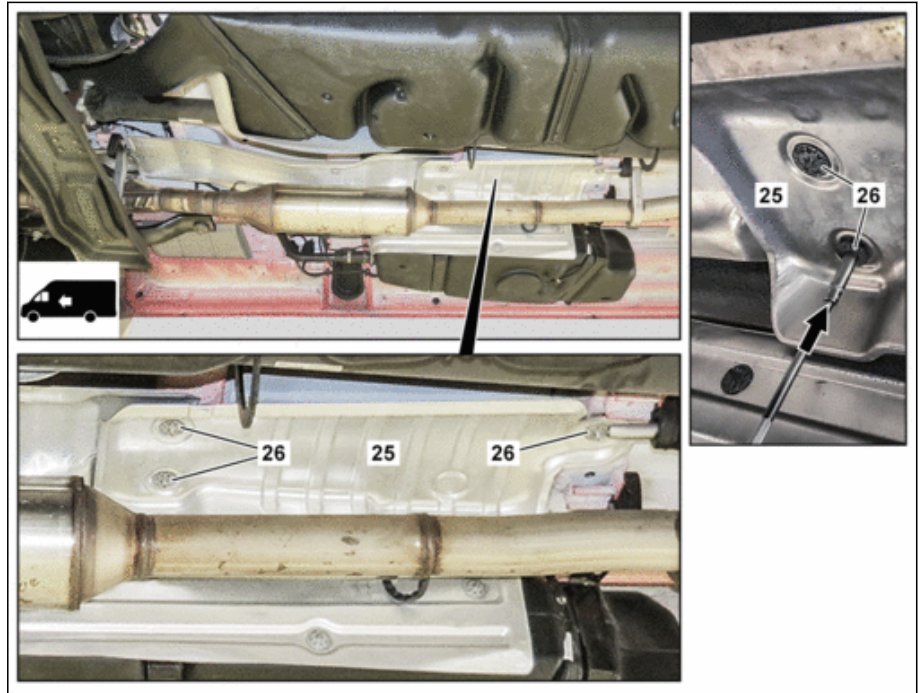

- 40 Install the new mounting tab (34) on the heat shield (25).



**A 220 546 18 43**

- 41 Clip the harness (32) into the mounting tab (34).



Do not kink the harness (32) and make sure it is not routed so as to be abraded.

This prevents damage.



The harness (32) must not touch heat shield (25).

This prevents damage.



The layout schematic of the harness (32) has changed on account of the changed position of the NO<sub>x</sub> sensor downstream of the SCR catalytic converter (4).

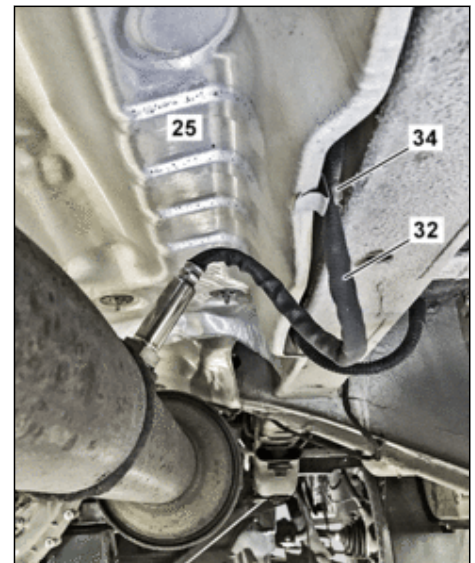

- 42 **Lift:**  
Lower the vehicle.

**Ramps:**

Vehicle may remain on ramps

## Execution of the AEM Special Procedure

- 43 Connect the battery charger to the vehicle's jump posts as indicated. (arrows)



**A sufficient power supply to the vehicle on-board system must be ensured throughout the entire work procedure.**

**Otherwise any undervoltage that occurs may damage the control units.**



Do not connect the battery charger to the auxiliary battery in the engine compartment.



Follow the operating instructions for the battery charger.



Use a Mercedes-Benz recommended battery charger to ensure an adequate voltage supply (min. 12.5 V) is provided for the on-board electrical system battery.





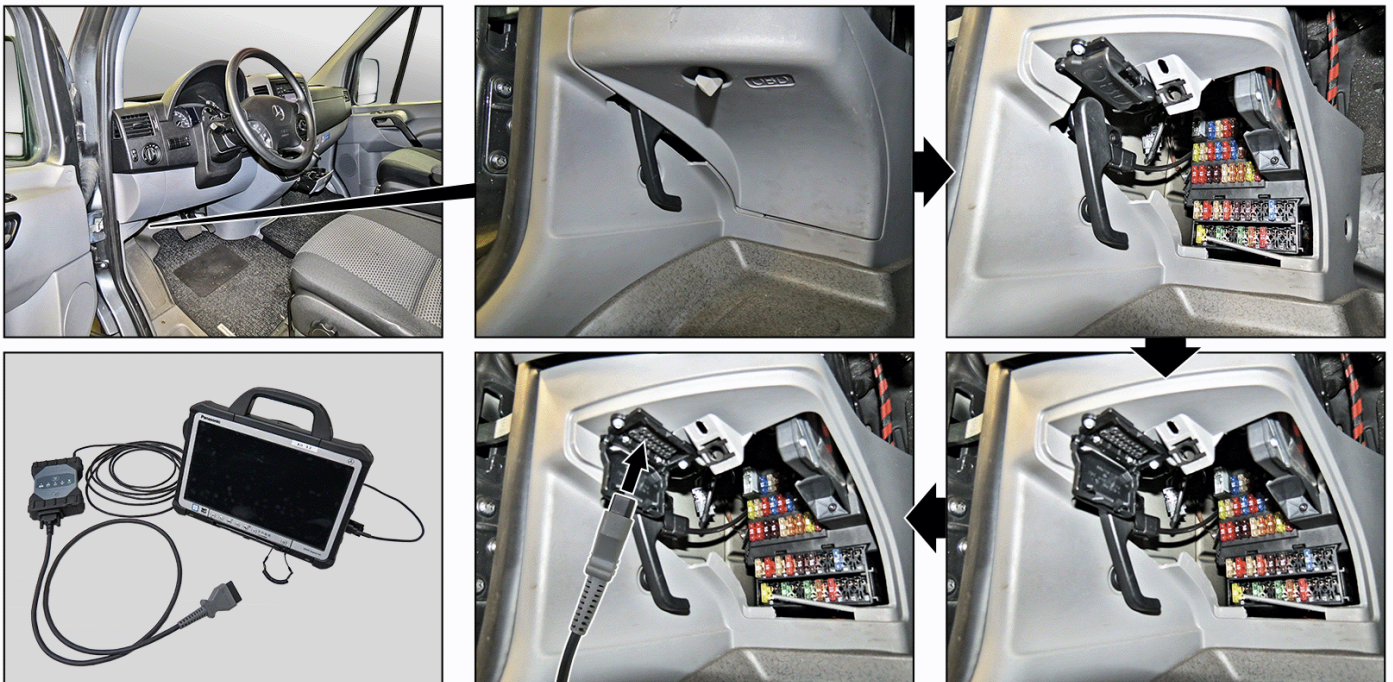

44 Connect the diagnostic system.



The diagnostic system remains connected to the vehicle throughout the work procedure!  
Do not disconnect the diagnostic system's online connection.

45 Switch on the ignition.

46 Start the diagnostic system.

47 Run XENTRY and start special procedure of customer service measure.



To do this, select the following menu items: Control unit view → N3/33 - Motor electronics 'CDI43' for combustion engine 'OM651' (CDI) (Code: MH5|MH8) → Special procedures → Service measure "Exhaust gas after-treatment"



The process starts automatically after starting the special procedure.  
The operation steps must be performed exactly as per the diagnostic system.

If a fault arises during the special procedure, repeat the procedure. If the fault persists, create a PTSS case or XSF-ticket including the following:

- Initial Quick test
- Current Quick test
- Control unit log
- AEM Result Report
- Support Packag

A result report is displayed at the end of the special procedure. Upload this report to paperless pXD. The report must indicate "OK" for all items. Otherwise, the procedure must be repeated. The vehicle can only be returned to the customer after successfully completing the special procedure.



Parts of the procedure via the diagnostic system are shown on the following pages.

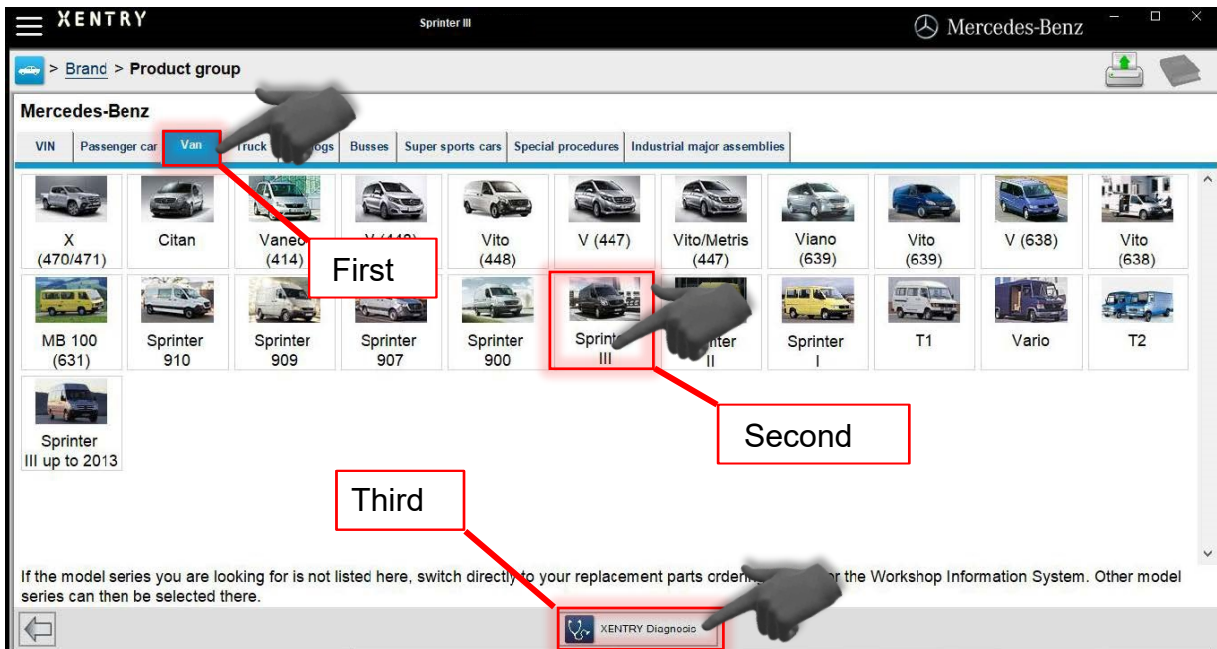

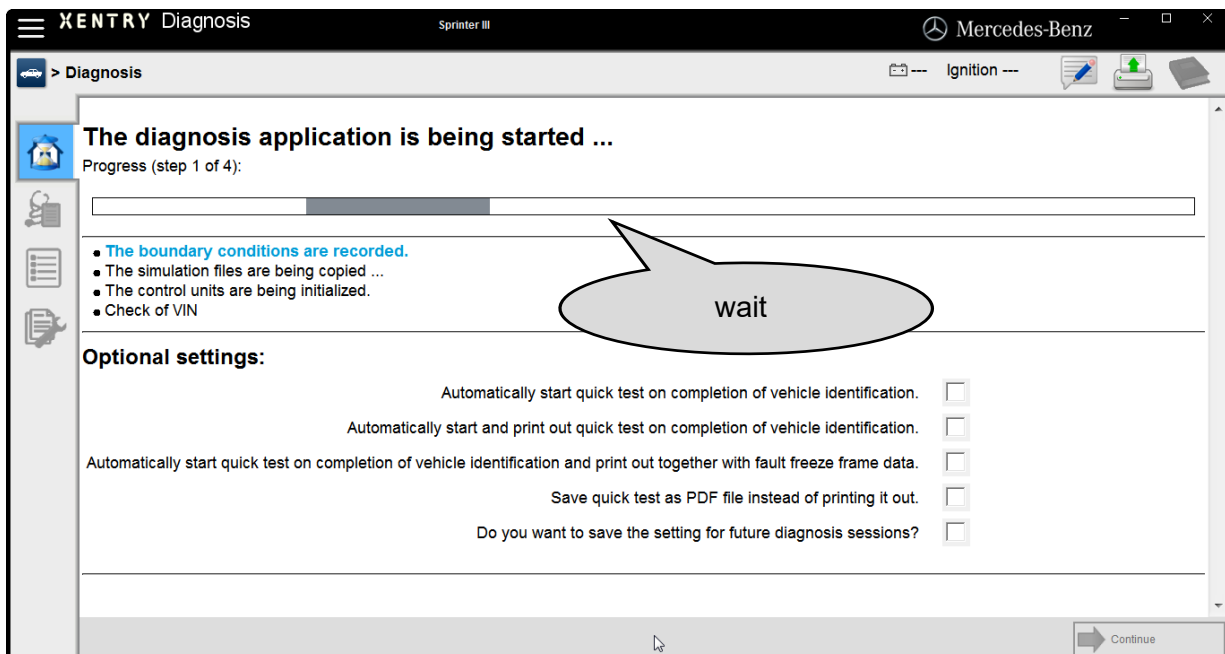
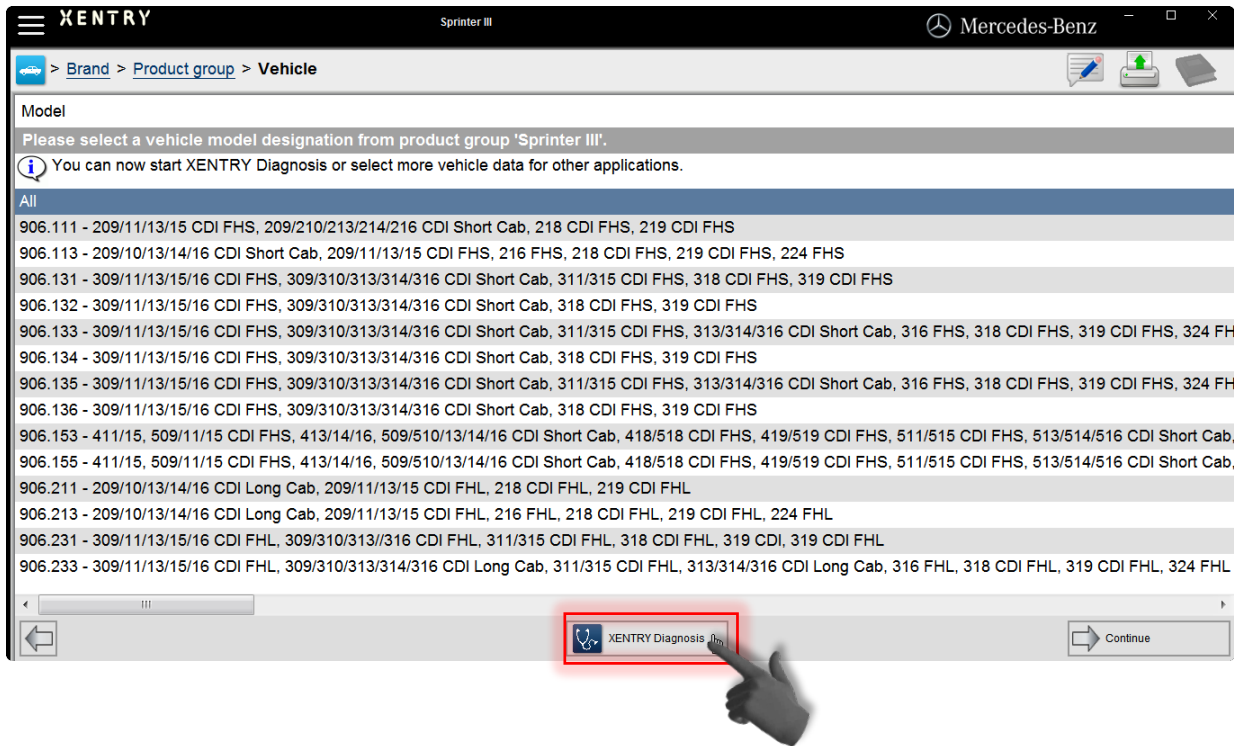



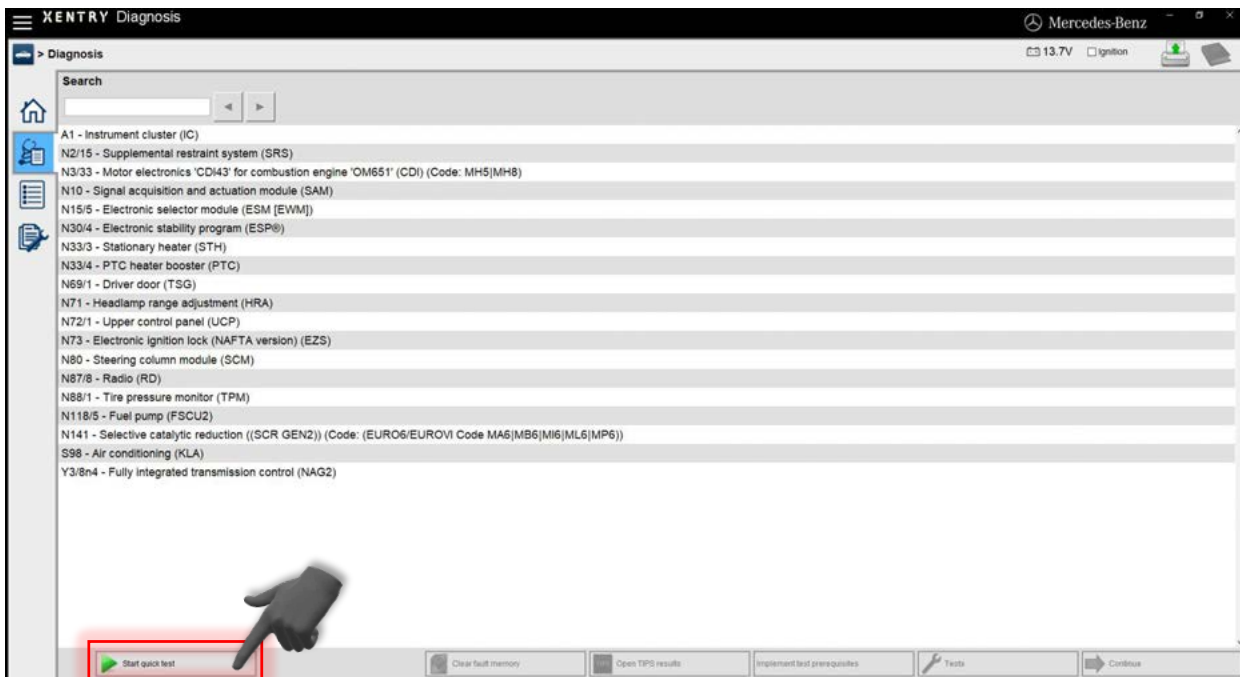
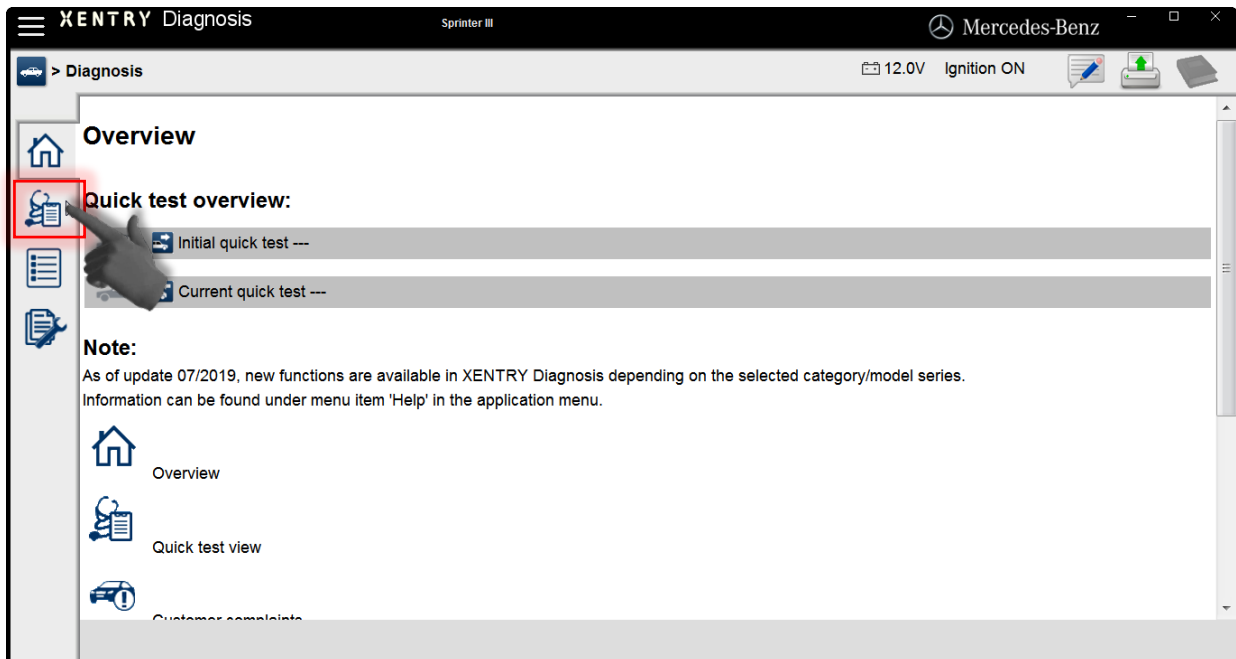

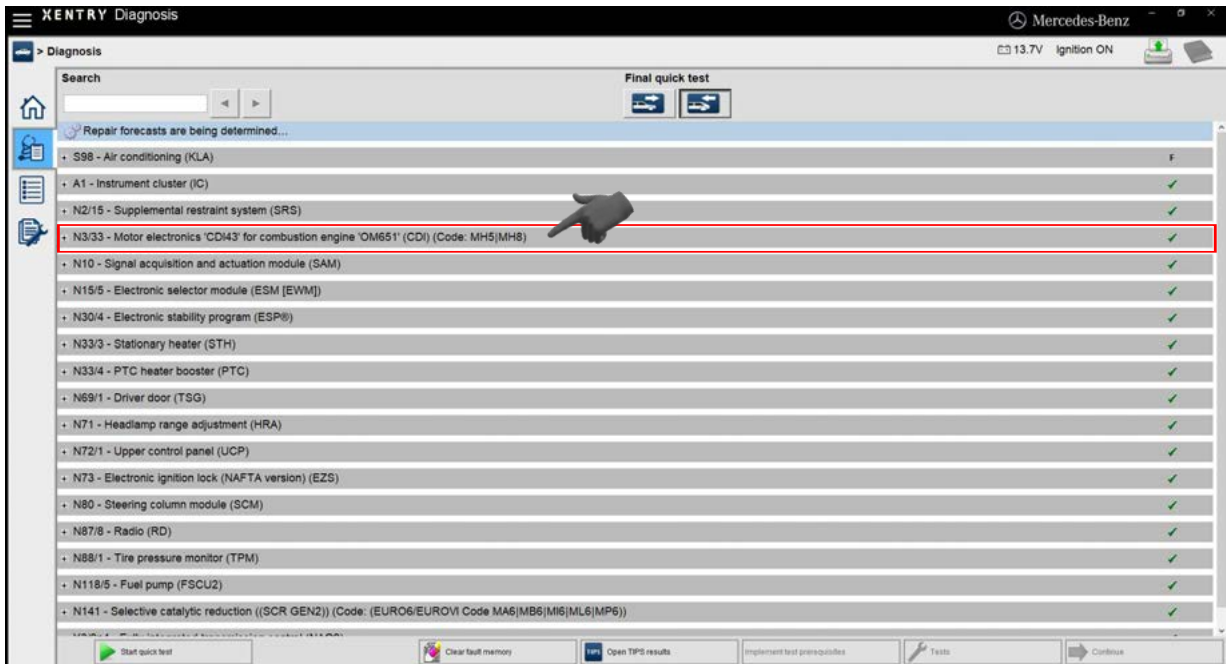
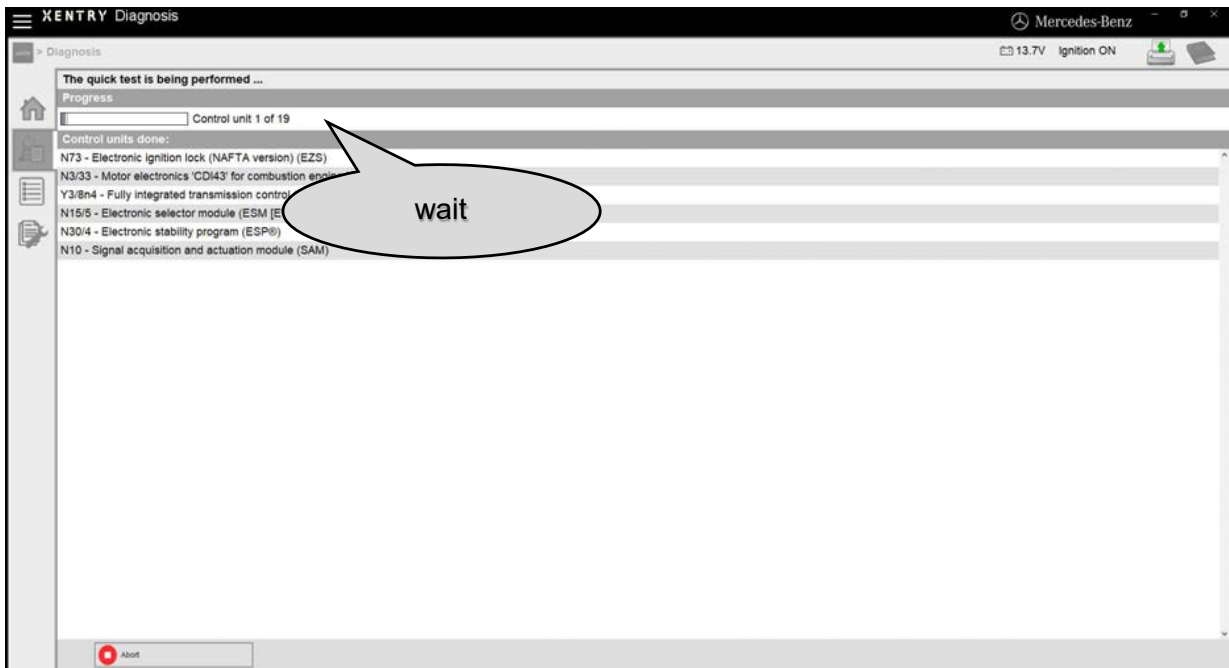

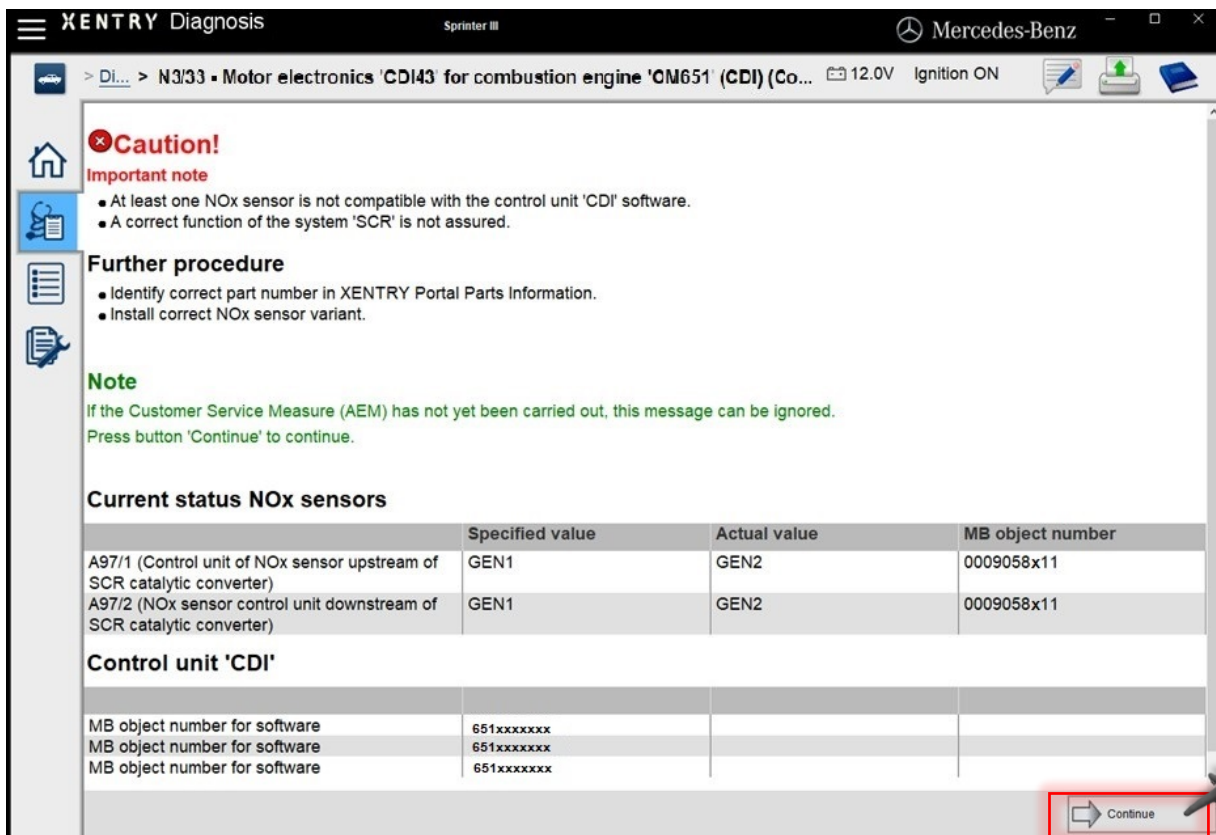
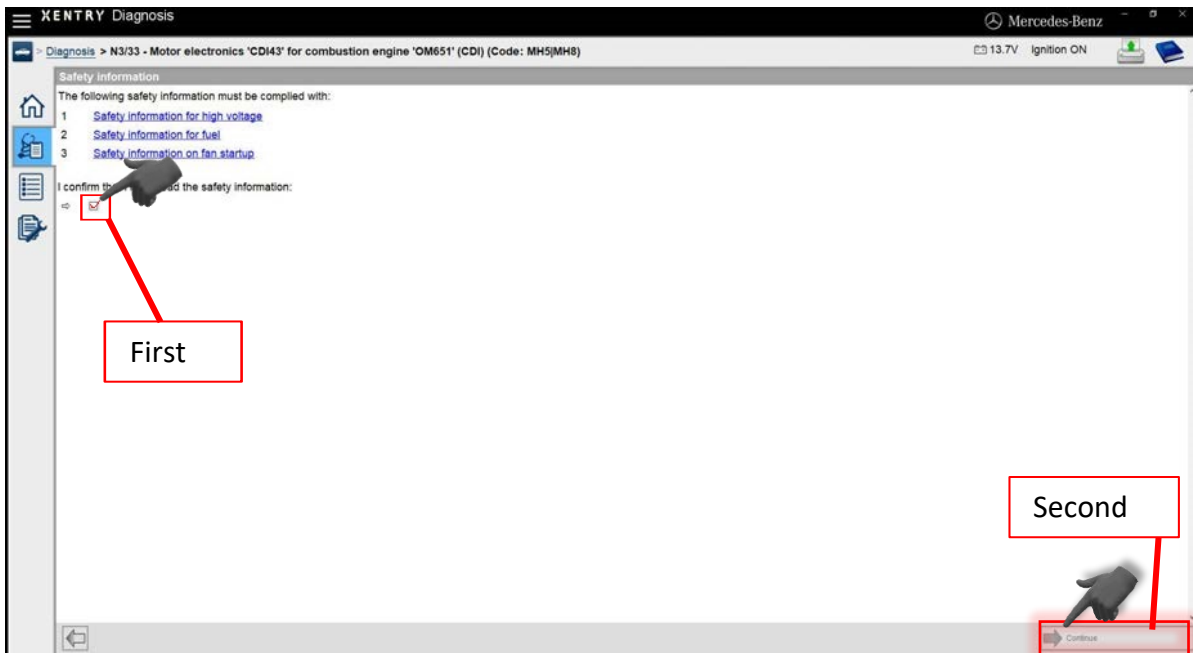

Caution page is for information only, and can be ignored when performing the AEM. Select 'Continue' to proceed with the AEM Service Measure.



XENTRY Diagnosis Mercedes-Benz

> Di... > N3/33 - Motor electronics 'CDI4.3' for combustion engine 'OM651' (CDI) (Code: MH5|MH8) 12.0V Ignition ON

Version | Error codes / Events | Actual values | Actuators | Adaptations | Control unit log | **Special procedures** | List of fault codes | Tests | Symptoms

Selection

Perform service measure "Exhaust aftertreatment".

- Recording of measurement values for function 'Exhaust gas recirculation'
- Collation of diagnosis performance data
- Resetting warning message 'SCR/AdBlue@'
- Resetting warning message 'Number of engine starts'
- Emissions inspection (AU)
- Special procedure "Winnebago"
- Delete fault memory and record diagnosis performance data.
- Preconditioning of exhaust test
- Service measure "Exhaust aftertreatment"**
- Pre-inspection
- Perform service measure "Exhaust aftertreatment".**
- Extended Warranty Parts

First

Second

Third

No selection made

XENTRY Diagnosis Mercedes-Benz

Diagnosis > N3/33 - Motor electronics 'CDI4.3' for combustion engine 'OM651' (CDI) (Code: MH5|MH8) 13.7V Ignition ON

Service measure "Exhaust aftertreatment"

**Explanation**

The processes required for the service measure are provided.

The following steps are performed:

Step 1

- Check requirements.

Step 2

- Control unit programming N3/33 (CDI control unit)
- Control unit programming N141 (AdBlue@ control unit)
- Control unit programming Y3/8n4 (Fully integrated transmission control control unit)
- Control unit programming A1 (instrument cluster)

Step 3

- Check of control unit software

**Question**

Do you want to perform the service measure now?

NO YES

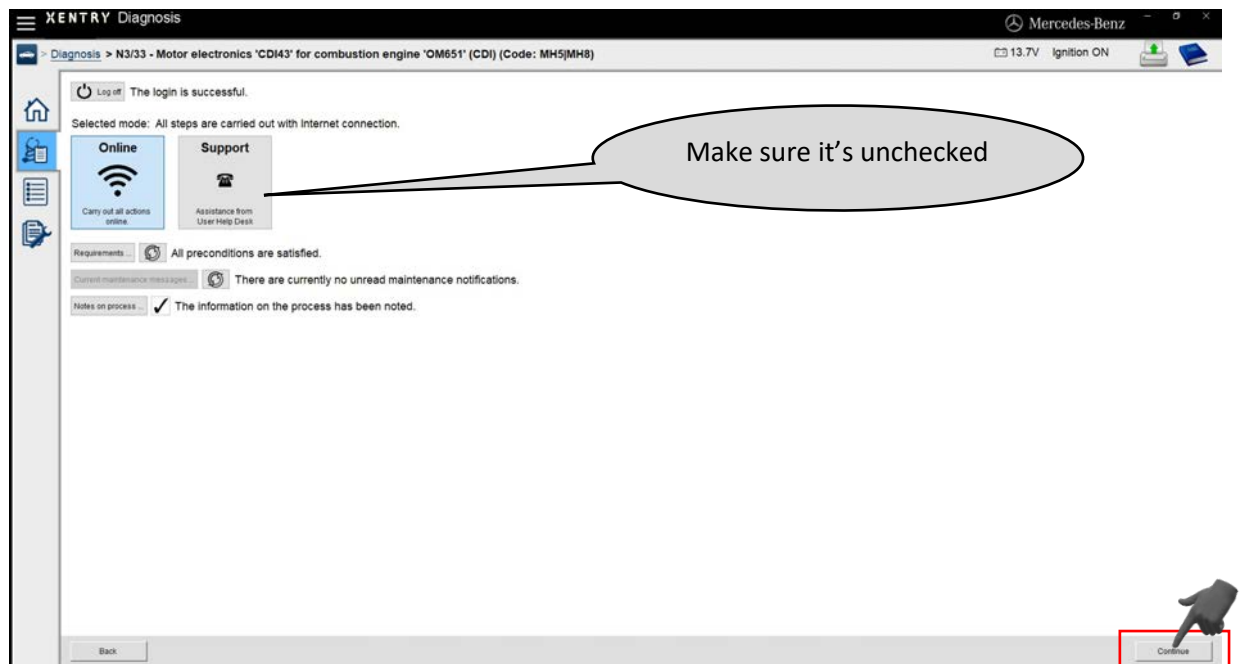
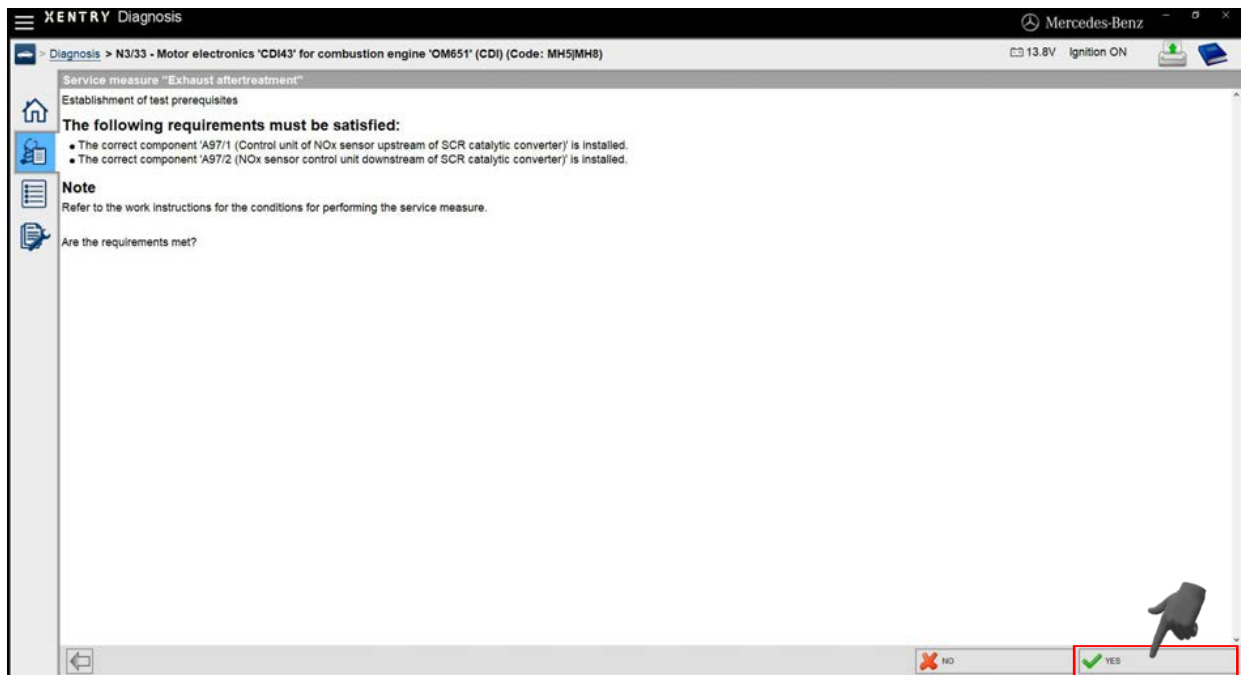

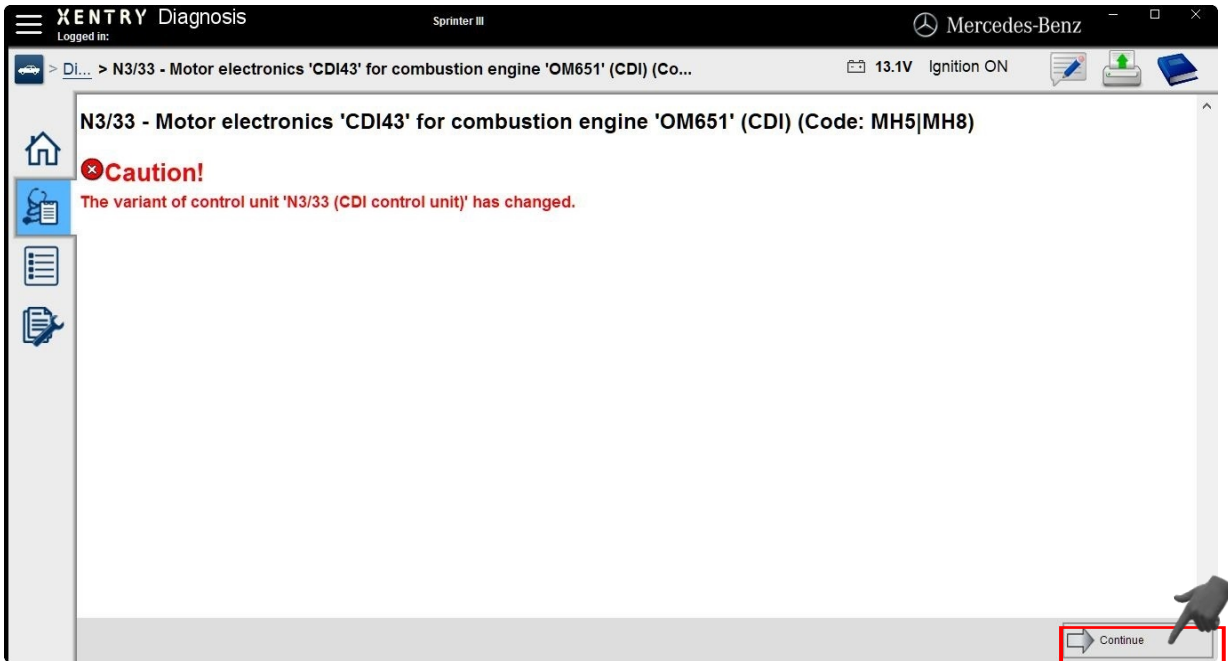

Caution page is for information only, and can be ignored when performing the AEM. Select 'Continue' to proceed with the AEM Service Measure.

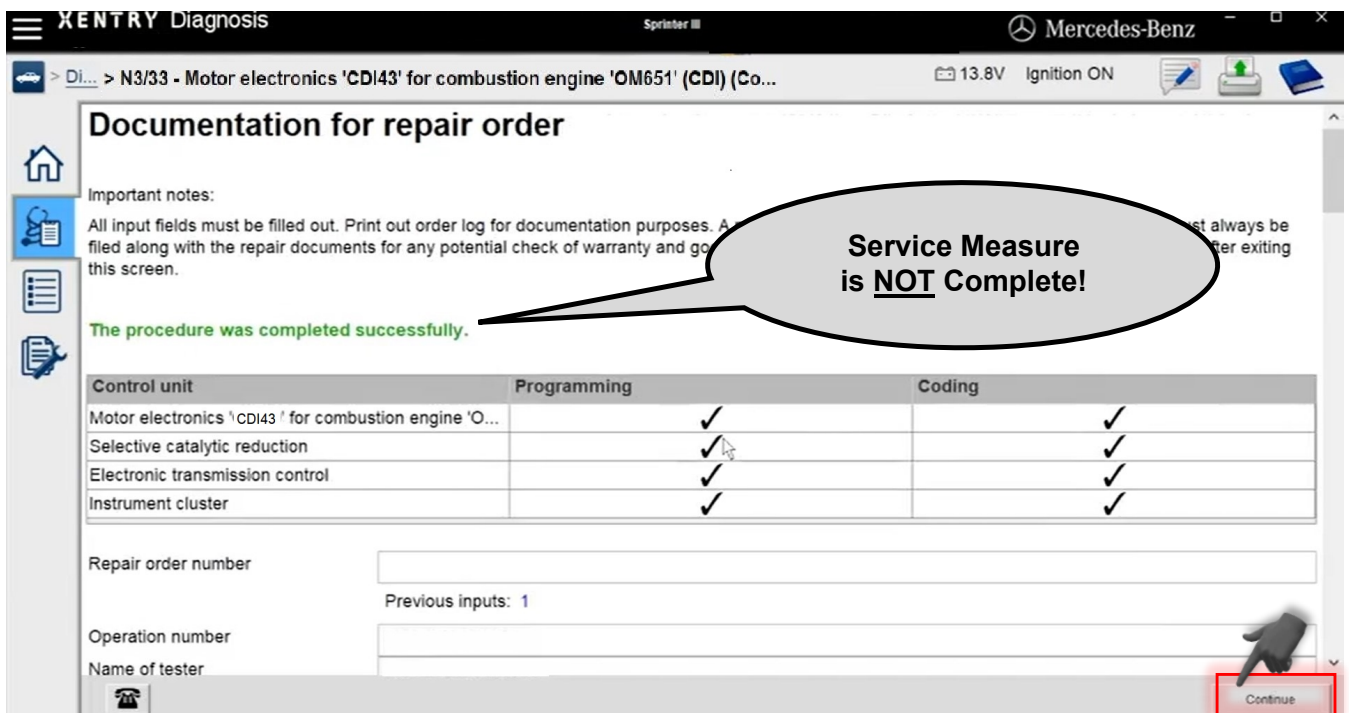

This is **NOT** the final results page. Select 'Continue' to proceed with the AEM Service Measure.



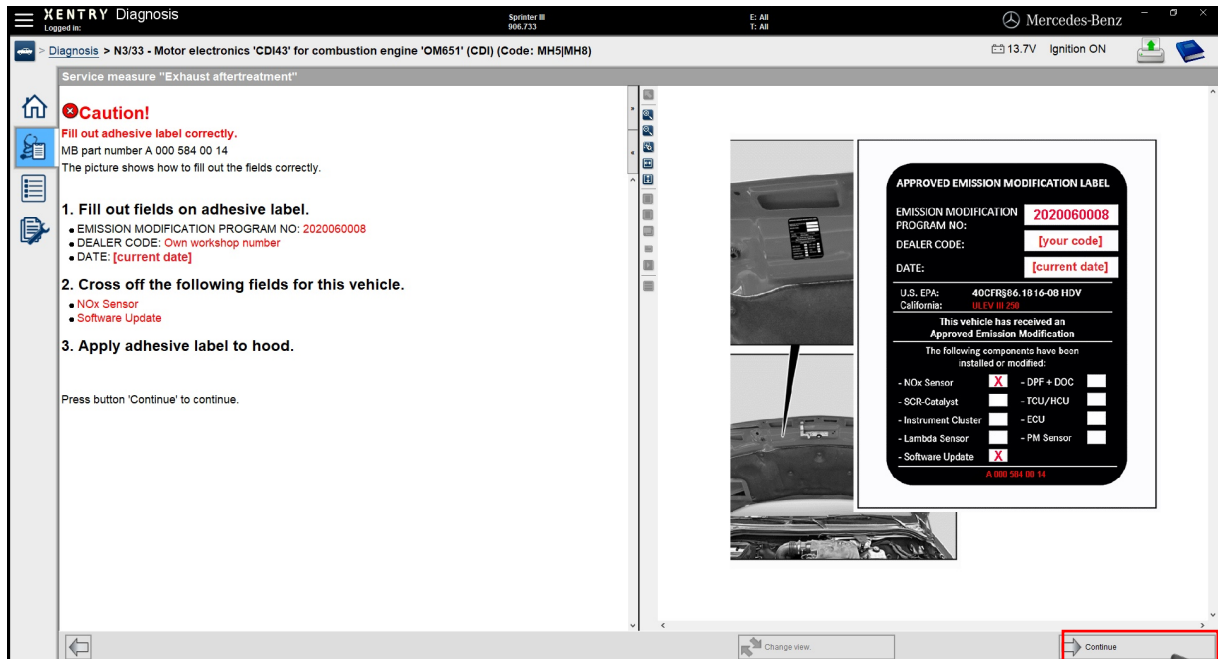

48

Complete the information on the APPROVED EMISSION MODIFICATION LABEL and attach it to the hood near the hood lock.



The attachment areas must be entirely free from dust and grease.

Otherwise, adequate adhesion cannot be ensured.



Fill in Emission Modification Program No., your dealer code, the date of the repair and mark the components that have been installed or modified. Use a black ultra fine point permanent marker.



A 000 584 00 14



Failure to comply may result in dealer debit and/or possible fines.



APPROVED EMISSION MODIFICATION LABEL	
EMISSION MODIFICATION PROGRAM NO:	2020060008
DEALER CODE:	[your code]
DATE:	[current date]
U.S. EPA: 40CFR§86.1816-08 HDV	
California: ULEV III 250	
This vehicle has received an Approved Emission Modification	
The following components have been installed or modified:	
- NOx Sensor	<input checked="" type="checkbox"/> - DPF + DOC <input type="checkbox"/>
- SCR-Catalyst	<input type="checkbox"/> - TCU/HCU <input type="checkbox"/>
- Instrument Cluster	<input type="checkbox"/> - ECU <input type="checkbox"/>
- Lambda Sensor	<input type="checkbox"/> - PM Sensor <input type="checkbox"/>
- Software Update	<input checked="" type="checkbox"/>
A 000 584 00 14	



**Service measure "Exhaust aftertreatment"**  
The procedure was completed successfully.

**Overview**

Control unit	Status 'Service measure'
N3/33 (CDI control unit)	CURRENT
N141 (AdBlue® control unit) (GEN2)	CURRENT
Y3/8n4 (Fully integrated transmission control control unit)	CURRENT
A1 (Instrument cluster)	CURRENT
A97/1 (Control unit of NOx sensor upstream of SCR catalytic converter)	OK
A97/2 (NOx sensor control unit downstream of SCR catalytic converter)	OK
VeDoc Code OA3	OK
VeDoc Code OA0	OK
VeDoc Code OC2	OK

**Detailed view**

Control unit	Software version	Status of software
<b>N3/33 (CDI control unit)</b>		
MB object number for software		✓
MB object number for software		✓
MB object number for software		✓
SCN coding		✓
<b>N141 (AdBlue® control unit) (GEN2)</b>		
MB object number for software		✓
MB object number for software		✓
MB object number for software		✓
<b>Y3/8n4 (Fully integrated transmission control control unit)</b>		
MB object number for software		✓
<b>A1 (Instrument cluster)</b>		
Software version		
Status of software		

**Service measure "Exhaust aftertreatment"**  
The procedure was completed successfully.

**Overview**

Control unit	Status 'Service measure'
N3/33 (CDI control unit)	CURRENT
N141 (AdBlue® control unit) (GEN2)	CURRENT
Y3/8n4 (Fully integrated transmission control control unit)	CURRENT
A1 (Instrument cluster)	CURRENT
A97/1 (Control unit of NOx sensor upstream of SCR catalytic converter)	OK
A97/2 (NOx sensor control unit downstream of SCR catalytic converter)	OK
VeDoc Code OA3	OK
VeDoc Code OA0	OK
VeDoc Code OC2	OK

**Detailed view**

Control unit	Software version	Status of software
<b>N3/33 (CDI control unit)</b>		
MB object number for software		✓
MB object number for software		✓
MB object number for software		✓
SCN coding		✓
<b>N141 (AdBlue® control unit) (GEN2)</b>		
MB object number for software		✓
MB object number for software		✓
MB object number for software		✓
<b>Y3/8n4 (Fully integrated transmission control control unit)</b>		
MB object number for software		✓
<b>A1 (Instrument cluster)</b>		
Software version		
Status of software		

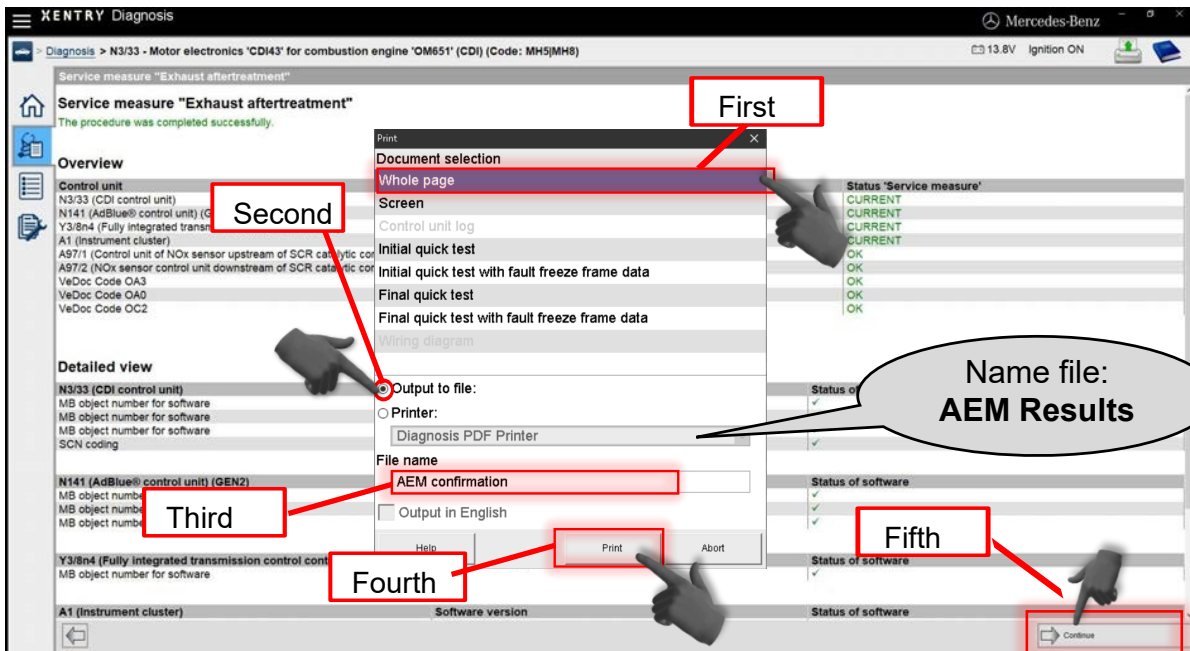
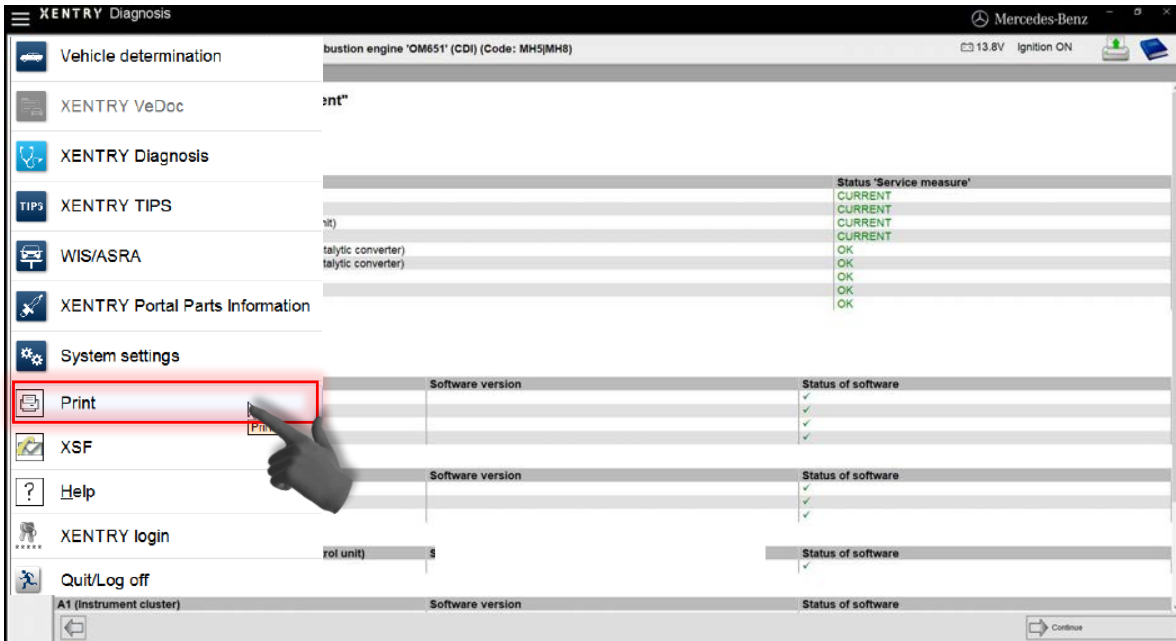

## Final Quick Test

49 Perform a final quick test and upload to paperless pXD.



Faults stored in the memory must be deleted from the fault memory after completing the work.



If faults are current and stored in the updated control modules they need to be addressed. If technical hardships occur create a PTSS ca•^È



The procedure via the diagnostic system is shown on the following pages.

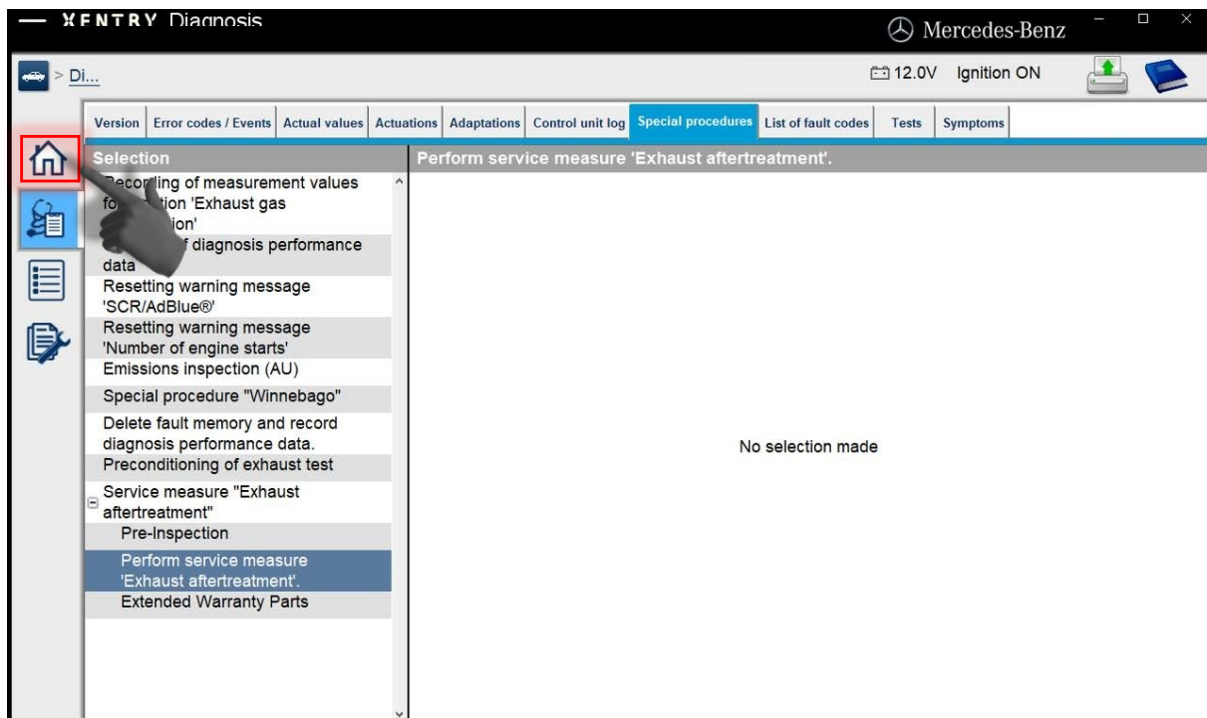

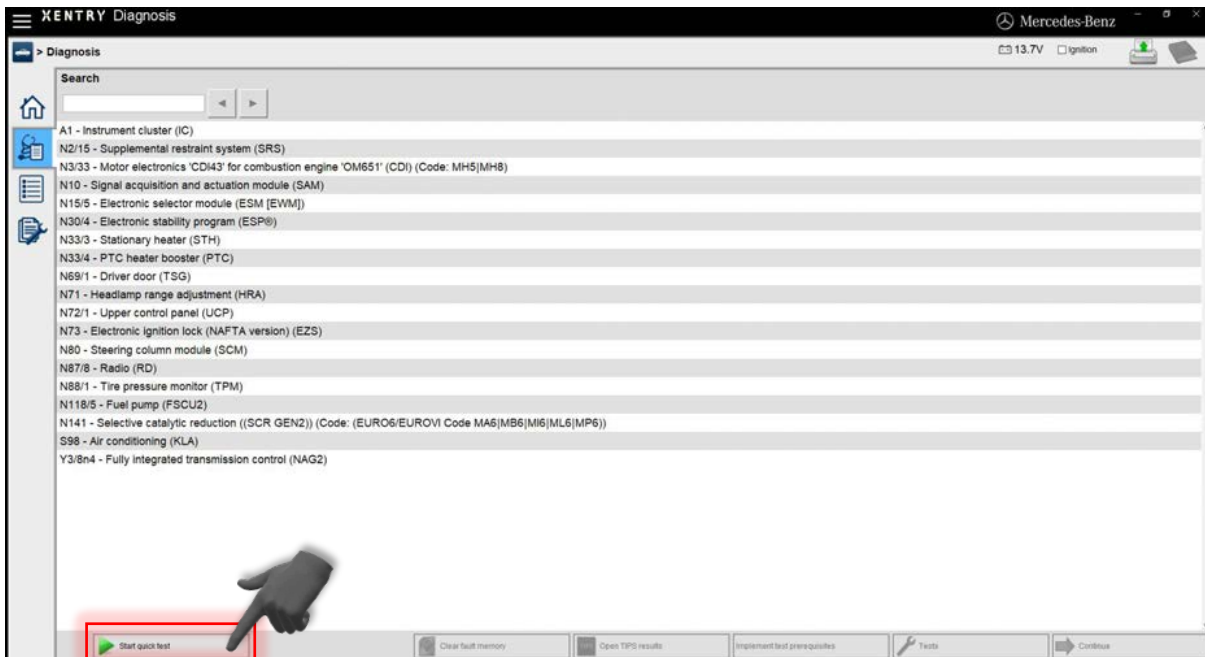
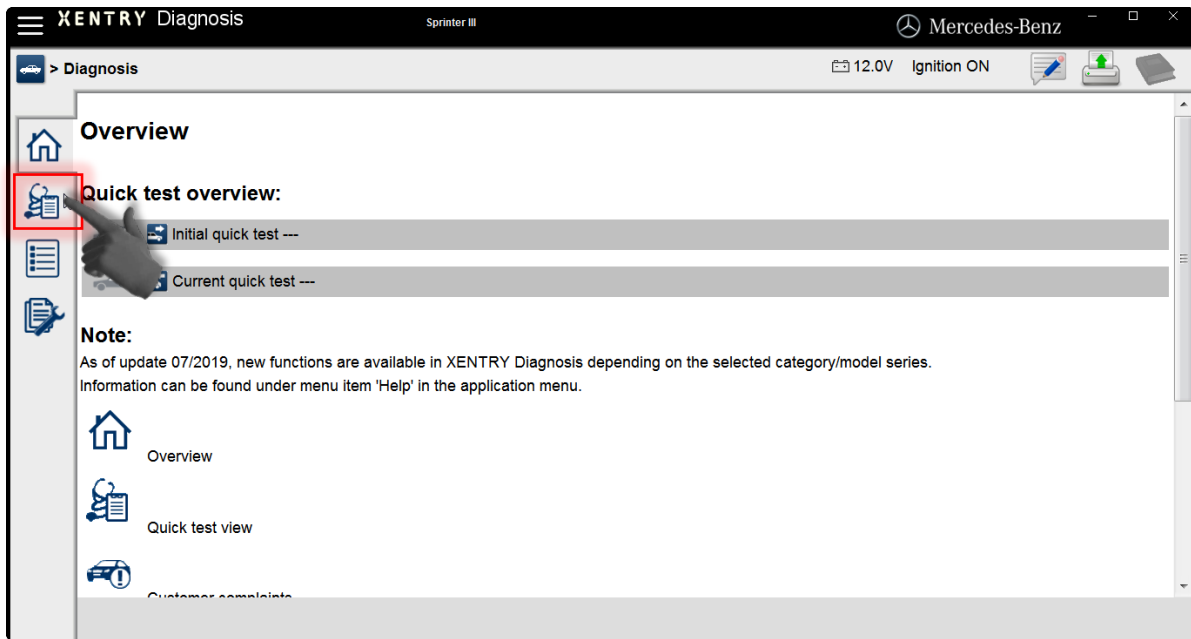

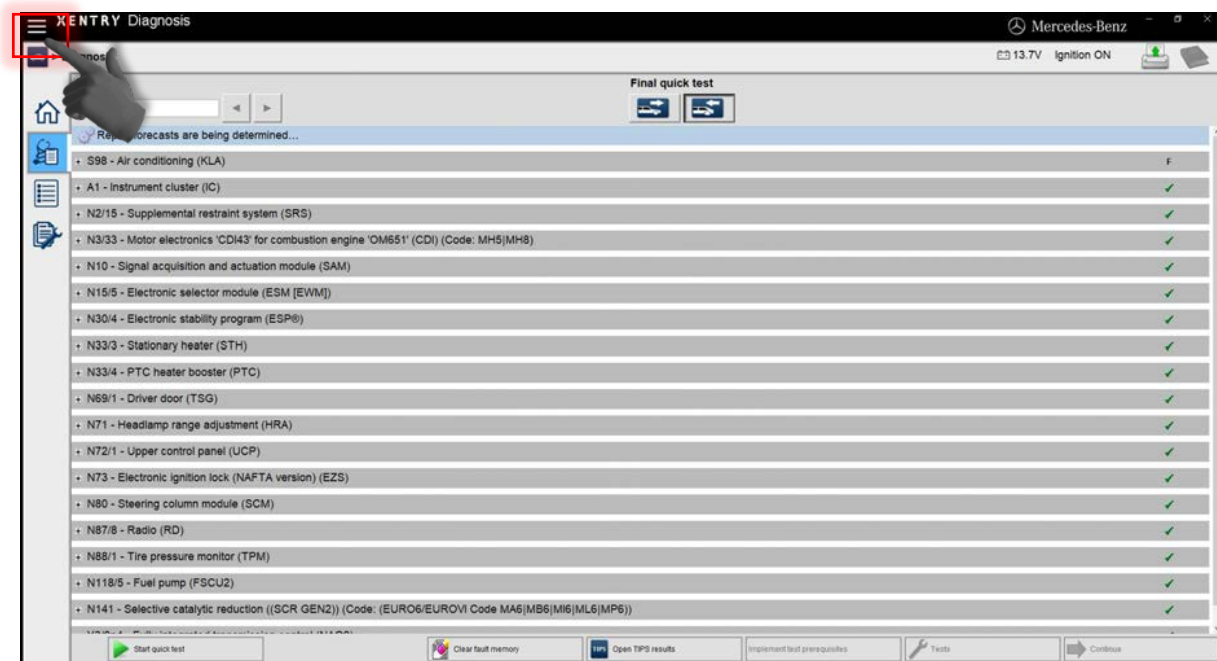
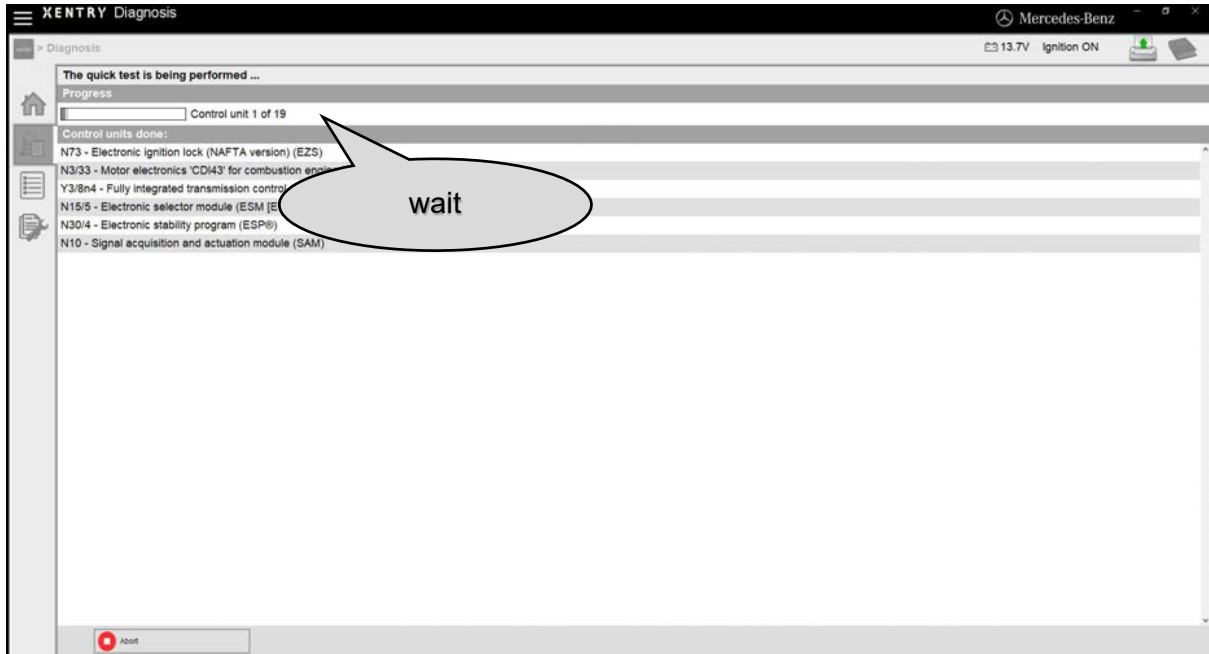



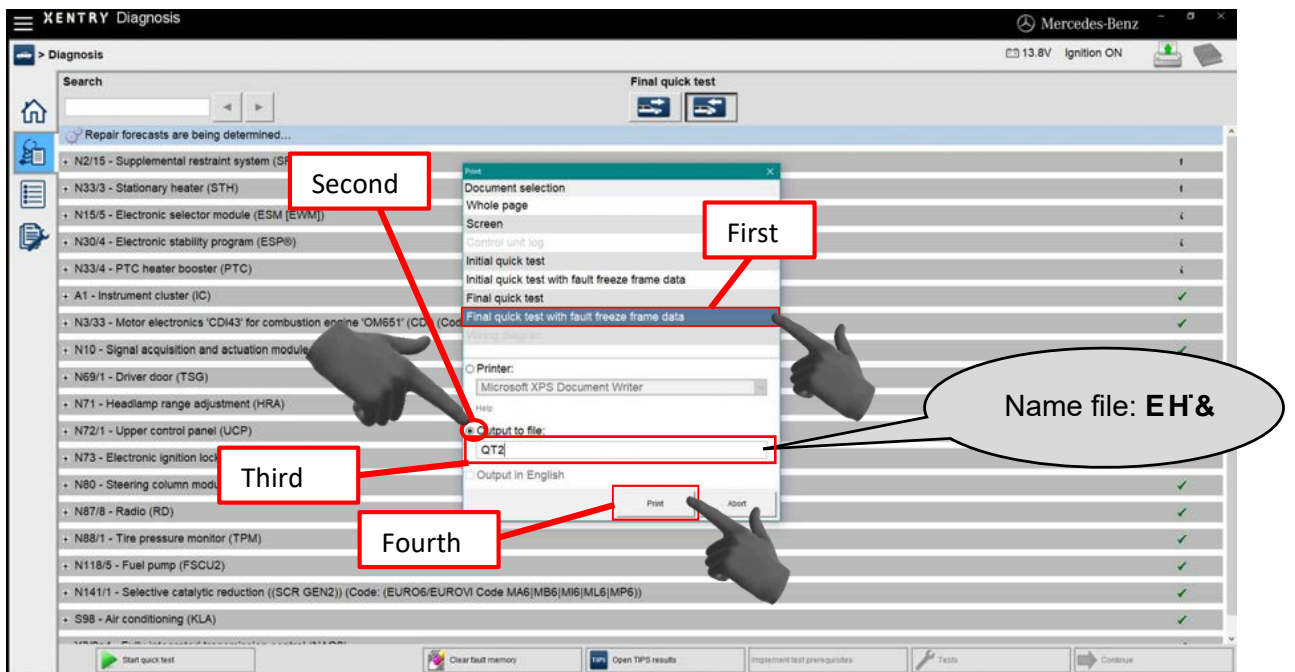
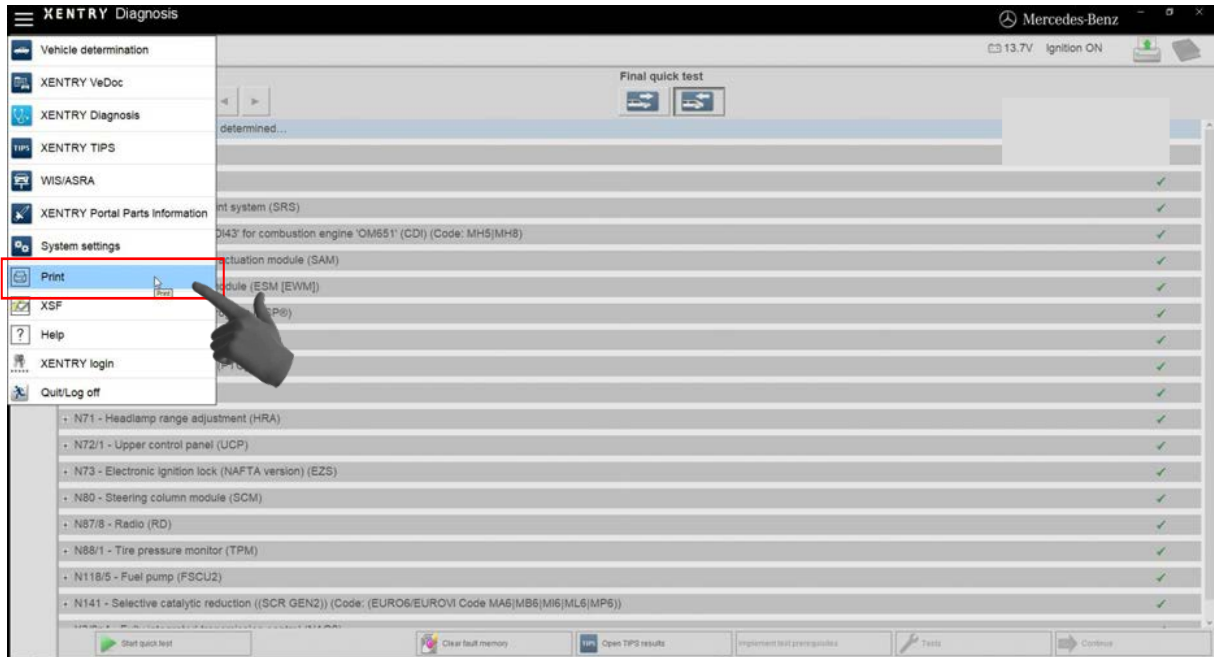

## 50 End the XENTRY session

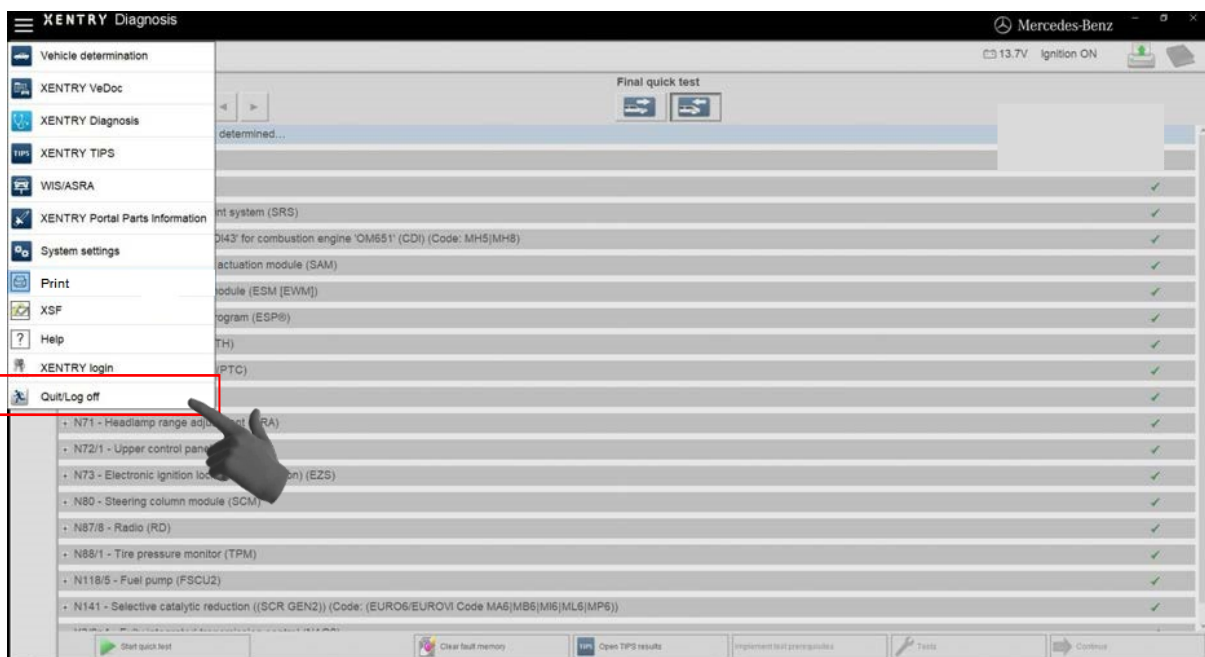
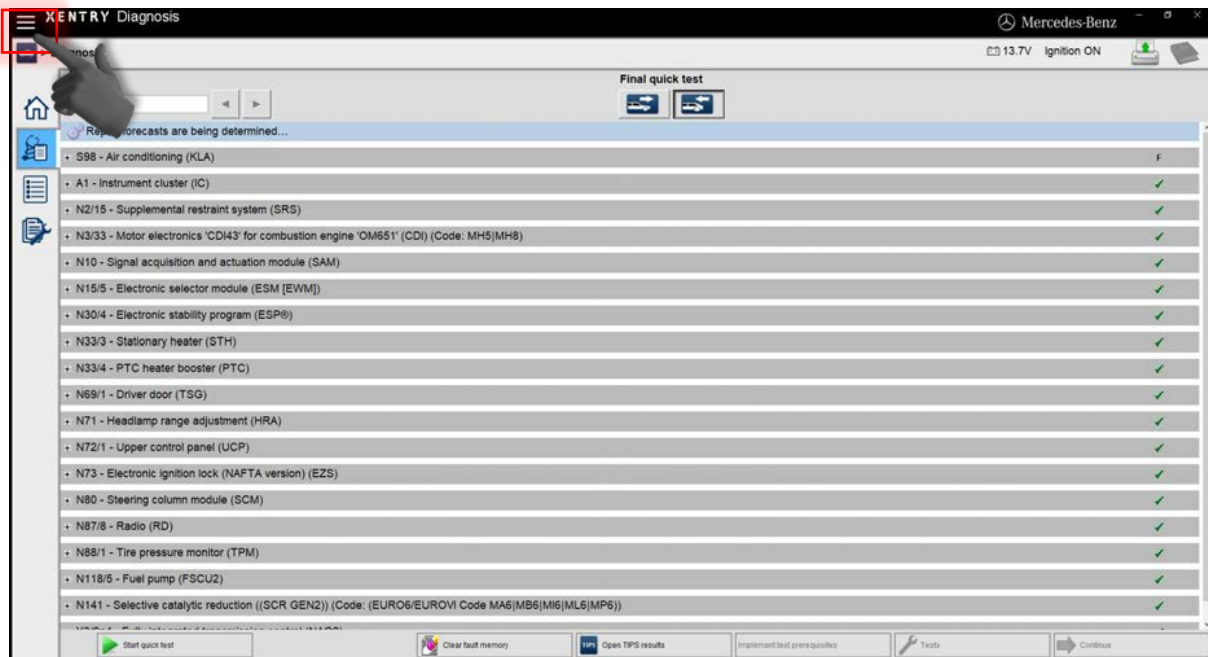

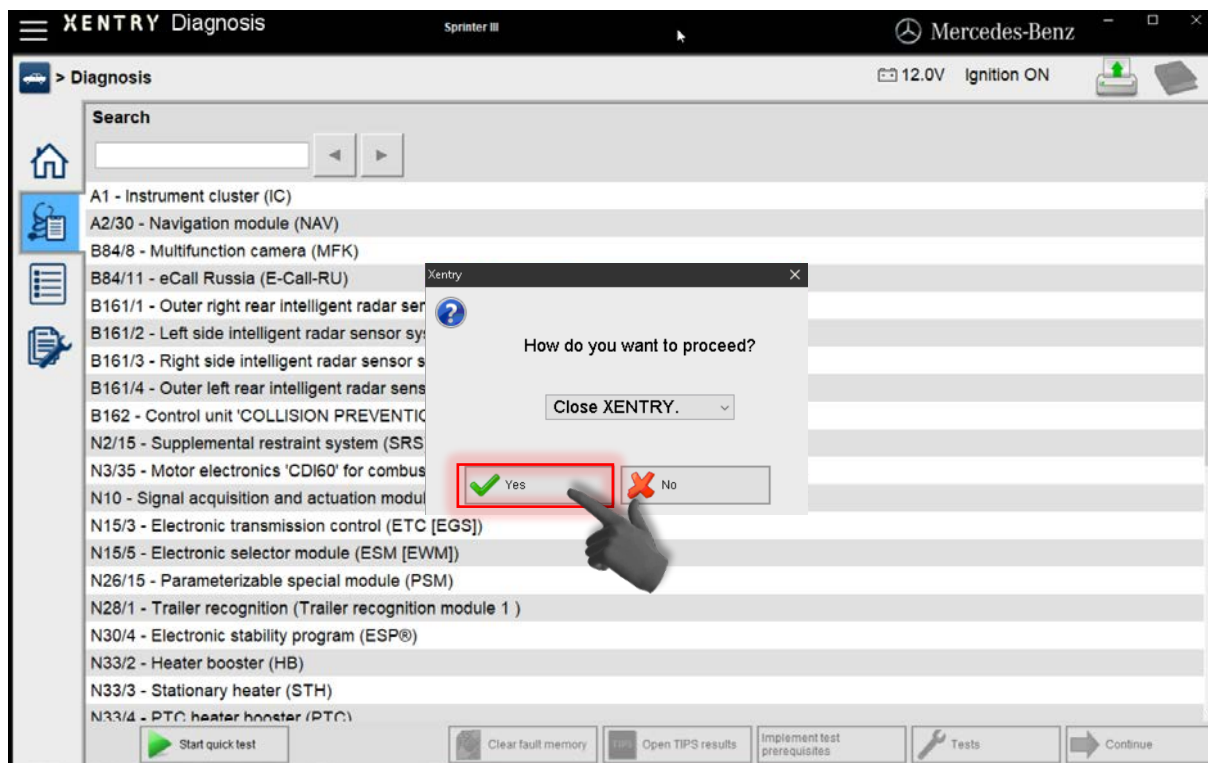

- 51 Switch off the ignition.
- 52
- 53
- 54 Close the hood.
- 55 Connect any aftermarket devices that were connected to the X11/4 diagnostic socket before.
- 56 **Ramps:**  
Remove wheel chocks, release parking brake, and drive the vehicle off the ramps.  
  
**Drive the vehicle slowly and at a constant speed off the ramps.**  
**Otherwise the vehicle may be damaged.**

**Replacement parts 2020060008**

<b>Part No.</b>	<b>Designation</b>	<b>Quantity</b>
A 651 905 10 00 85	NOx Sensor Package	1
N 000000 003477	Nut Fastener	4
A 000 994 32 11	Lock Pin	4
A 000 584 00 14	APPROVED EMISSION MODIFICATION LABEL (ULEV III 250)	1
A 220 546 18 43	Mounting Tab	1
A 007 997 56 90	Cable Tie With Clip	2