



Mercedes-Benz

Campaign No. 2020040008, May 2022

TO: ALL MERCEDES-BENZ and FREIGHTLINER SPRINTER CENTERS

SUBJECT: **Model 906 (Sprinter)**
Model Year 2010 - 2012
Modification to the emissions control system

Daimler Vans USA, LLC ("DVUSA") and Mercedes-Benz USA, LLC ("MBUSA") are performing an emissions campaign on certain 906 Sprinter vehicles in order to modify to the vehicles' emissions control system. EPA and CARB have approved this emissions modification for these MY10 - 12 Sprinter (Model 906) vehicles. An authorized Mercedes-Benz or Freightliner Sprinter dealer will replace certain emissions control system components and update certain software in the affected vehicles at no cost to the owner of the vehicle.

Prior to performing this Emissions Campaign:

- Please check VMI to determine if the vehicle is involved in the emissions modification campaign and if it has been previously repaired. Always Check VMI for any open campaigns, and perform accordingly.
- Please review the entire Emissions Campaign bulletin and follow the repair procedure exactly as described.

Approximately 46,157 vehicles are involved.

Order No. V-RC-2020040008

This bulletin has been created and maintained in accordance with MBUSA-SLP S423QH001, Document and Data Control, and MBUSA-SLP S424HH001, Control of Quality Records.



Emissions Campaign 2020040008

Update May 2022

- Model: 906 Sprinter
- Model Year: 2010 - 2012
- Engine: 6-Cylinder Diesel (OM 642)

Warranty Information

Damage Code	Operation No.	Time	Operation Text
Denial of AEM			
49 10N 01	use operations for labor performed	up to 2 hr	Diagnosis time for pre-inspection if client declines to reverse non-compliant modifications
Perform AEM			
07 972 52	02 1218	2.4 hr	Perform work package for field measure
	02 1220	0.4 h	Additional labor for vehicle with auxiliary battery in engine compartment
Additional: Mobile AEM at customer location			
21 812 00	00 9627	+50%	Mobile AEM Labor surcharge
	sublet		\$75 travel allowance
Additional: Mobile AEM at customer location requiring overnight accommodation			
21 813 00	00 9627	+50%	Mobile AEM Labor surcharge
	sublet		\$100 travel allowance

Parts Overview

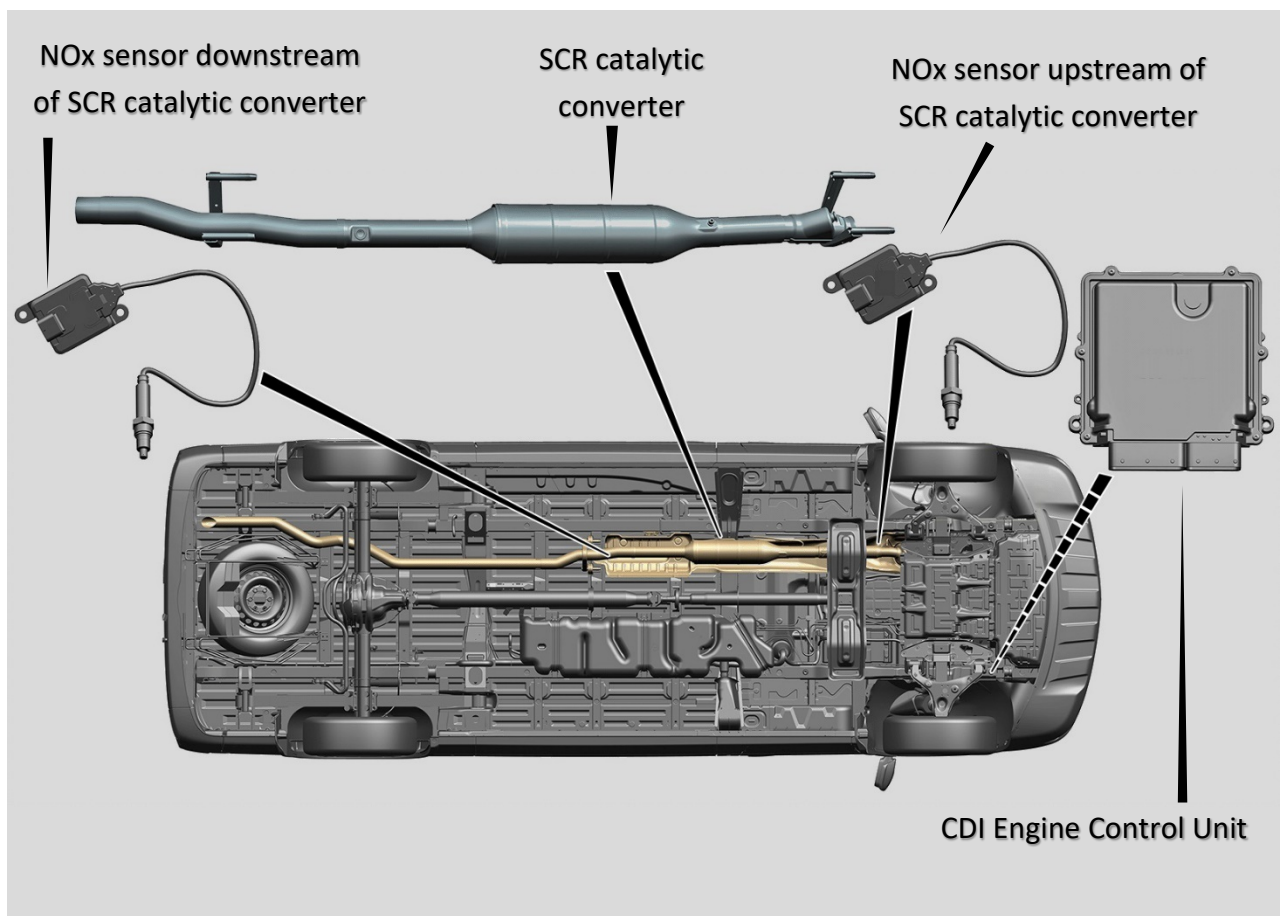

i Reference last page for complete list of parts to perform AEM



Scope of Work Outline

i Read and follow all pages of work instructions completely!	Page:
1. Safety Notes	4-18
2. Lifting and Ramps	19-21
3. Initial Quick Test	22-28
a. Upload print-out to paperless pXD	
b. Evaluate pre-existing faults (<i>see Pre-Inspection Guide below</i>)	
4. Pre-Inspection Special Procedure	29-33
a. Includes visual inspection of Exhaust Aftertreatment system (<i>see Pre-Inspection Guide below</i>)	
5. Replacement of AEM parts	34-46
a. NOx Sensor Upstream of SCR Catalytic Converter	
b. NOx Sensor Downstream of SCR Catalytic Converter	
c. SCR Catalytic Converter	
6. Execution of AEM Special Procedure	46-71
a. Includes guided steps to Replace CDI and Update Software of CDI, ETC, IC, and SCR	
b. Fill-out and Install AEM Label	
c. Result Report to verify successful completion of all AEM steps	
i. Upload print-out to paperless pXD	
7. Final Quick Test	71-74
a. Upload print-out to paperless pXD	
b. Erase stored faults caused by the workshop	
8. Parts List	76

Pre-Inspection Guide

- Pre-existing fault codes causing a Check Engine Light (CEL):**
 - If component causing fault will be replaced as part of the AEM:
 - Perform AEM - No additional action is needed
 - If component causing fault will be covered by the AEM Extended Warranty:
 - Perform AEM
 - Perform repair of pre-existing fault
 - Submit AEM Extended Warranty claims on a separate Repair Order after AEM claim is submitted
 - If component causing fault will not be replaced as part of AEM and not covered by AEM Extended Warranty:
 - Provide client with repair estimate, advise client AEM will not resolve Check Engine Light (CEL)
 - Document on Repair Order if client approves or declines repairs
 - Perform AEM regardless if client approves or declines repairs
 - A list of AEM Extended Warranty covered components is available in: XENTRY / CDI / Special Procedures / Exhaust Aftertreatment Service Measure / Extended Warranty
- Non-Compliant Alterations to the Exhaust Aftertreatment system found during the visual Pre-Inspection:**
 - Document all non-compliant alterations to the Exhaust Aftertreatment system on the Repair Order
 - If altered component(s) will be replaced as part of the AEM:
 - Perform AEM
 - If altered component(s) inhibit AEM installation or will sustainably affect the operation of the AEM:
 - Provide client with a repair estimate to reverse non-compliant alterations
 - If client approves repairs:
 - Reverse non-compliant alterations
 - Perform AEM
 - If client refuses repairs:
 - Do not perform AEM - Vehicle ineligible
 - Claim 'Denial of AEM' damage code and labor ops for diagnosis time performed
- If technical assistance is needed, create a PTSS case

AEM installation Videos

Exemplary videos of the AEM installation are available via the following:

- XENTRY Workshop (XiW) / VAN / Emissions Modification Program
- Scan the QR code below with a mobile device and log-in with your XENTRY credentials

#

†





Risk of injury. Skin or eye injuries may result when handling hot or glowing objects.

	Risk of injury. Skin or eye injuries may result when handling hot or glowing objects.	Wear protective gloves, protective clothing and safety glasses, if necessary.	 Warning
--	--	---	---

Risk of injury

Contact with hot or glowing objects without suitable protective clothing causes severe burns to skin and eyes.

When glowing objects come into contact with water, they produce hot steam or cause the water to splash, which can cause serious burns to skin or eyes.

If hot or glowing objects come into contact with unprotected skin or eyes, they can cause serious and even permanent injuries.



There is a risk of fire when glowing objects come into contact with combustible material.

Safety precautions/instructions

- Wear protective clothing, safety glasses and heat-resistant gloves.
- Only transport hot or glowing objects with suitable aids.
- Avoid the formation of sparks and contact with combustible material when handling glowing objects.

First aid measures

- Treat affected areas of skin with plenty of cold water and cover with sterile dressings.
- Consult a physician immediately.

Risk of accident from vehicle starting off by itself when engine running. Risk of injury (bruises and burns) resulting from working on the engine while it is being started or when it is running.

	Risk of accident from vehicle starting off by itself when engine running. Risk of injury (bruises and burns) resulting from working on the engine while it is being started or when it is running.	Secure vehicle to prevent it from starting off by itself. Wear closed and snug-fitting work clothes. Do not touch hot or rotating parts.	Warning
--	--	--	----------------

Potential risks

Risk of accident

Caused by the vehicle starting off by itself during the starting procedure

(e.g. during compression test) **due to engaged gear** or with the engine running and vehicles with automatic transmission **due to selector lever position "P" or "N"** not being engaged (except for vehicles that do not have selector lever position "P").

Risk of injury

Severe injuries can be caused by freely rotating parts in the area of the running engine.

Because the engine heats up when operating, serious burns can be caused by touching unshielded parts.

Safety instructions/precautions

- In general, only work on a running engine when it is absolutely necessary.
- **Apply parking brake** before starting the engine.
- The vehicle is to be secured against moving forwards or backwards.
- The person performing tests on a vehicle with the engine running must sit in the driver's seat to be able to prevent the vehicle from moving.

- It is not permitted for persons to be in the danger zone in front of or behind the vehicle while tests are being performed.
- **Shift the gearshift lever to neutral** on vehicles with manual transmission.
- On vehicles with automatic transmission, move **selector lever into position "P" or "N"** (except for vehicles that do not have selector lever position "P").
- On vehicles that do not have selector lever position "P", the **selector lever** is to be **secured against unauthorized access**.
- Wear closed and snug-fitting work clothes.
- Remove all jewelry such as necklaces, rings, etc.
- Wear suitable head wear to cover long hair.
- Before commencing any work on the running engine, familiarize yourself with the location of potentially hot parts.
- When carrying out work when starting the engine or when the engine is running, **do not touch any hot or rotating parts**.
- Use the exhaust extraction system.

First aid measures in the event of burns

- Do not rub the skin areas affected; rinse with plenty of cold water and cover skin with sterile dressings.

- Consult a physician immediately.



Risk of injury. Moving parts can pinch, crush or, in extreme cases even sever extremities.

	Risk of injury. Moving parts can pinch, crush or, in extreme cases even sever extremities.	No parts of the body or limbs should be within the operating area of mechanical components when moving components.	 Warning
--	---	--	--

Risk of injury

When working on components that can be moved either by hand, by means of electric motors, or hydraulically/ pneumatically via a connecting mechanism, serious injuries can occur due to body parts being cut, pinched or crushed.

Safety instructions/precautions

- Monitor hazard area.

- Secure the operating area of mechanical components against interference when parts are in motion.
- Never touch the mechanism of a component while it is being actuated by electric motors via the diagnosis or by direct actuation (terminal 30).
- Choose a test cable of sufficient length.

Risk of death caused by vehicle slipping or toppling off of the lifting platform.

	Risk of death caused by vehicle slipping or toppling off of the lifting platform.	Align vehicle between vehicle lift columns and position the four support plates at the vehicle lift support points specified by the vehicle manufacturer.	 Danger
--	--	---	---

Risk of accident and injury

Ensure that the vehicle is ideally aligned and secured against tilting according to the general safety specifications and regulations.

Non-observance of the safety specifications can cause the vehicle to **slip off** the lift system and thereby result in **life threatening** or **fatal** injuries.



This list of hazards is not complete.

The safety specifications of the respective country are always valid. The user is personally responsible for complying with these.

Risk of burn injuries and scalding when working at AdBlue® lines and the components attached to them. Risk of injury to skin and eyes when handling AdBlue®. Risk of poisoning caused by swallowing AdBlue®

	<p>Risk of burn injuries and scalding when working at AdBlue® lines and the components attached to them. Risk of injury to skin and eyes when handling AdBlue®. Risk of poisoning caused by swallowing AdBlue®</p>	<p>Pour AdBlue® into suitable containers only. Wait until the pressure is released before starting any work on the exhaust aftertreatment system.</p>	 Warning
--	---	---	--

Potential risks

Risk of burn injuries and scalding

The AdBlue® lines and all components attached to them are under pressure during operation and remain so after the engine is switched off and may be hot. There is a risk of burn injuries. There is a risk of scalding caused by escaping hot AdBlue® when the line system is opened.

Risk of injury

There is a risk of skin irritation and eye damage on contact with AdBlue®.

Risk of poisoning

There is a risk of poisoning if AdBlue® is swallowed.

Rules of conduct

- On vehicles with electrical delivery pump, the AdBlue® is pumped from the line back into the AdBlue® tank after the engine is switched off.

- On vehicles with a compressed air system, individual lines are flushed with compressed air after the engine is switched off. The engine must therefore be switched off for at least 5 minutes before work on the exhaust aftertreatment system may begin.
- Open connections and plugs on the system components slowly. Cover the connecting point with rags when opening.
Only pour AdBlue® into marked containers specially designated for the purpose. Do not pour AdBlue® into drinking containers.
- Wipe up any AdBlue® spills immediately as there is a high risk of someone slipping.

Safety precautions for handling removed parts and working under the vehicle

- Wear suitable protective gloves
- Wear protective clothing
- Wear safety glasses

First aid measures

Contact with skin: Wash the affected skin areas with plenty of clean water. Change wetted clothing as quickly as possible.

Contact with eyes: In the event of contact with eyes, immediately rinse eyes thoroughly with plenty of clear water; contact an eye doctor if necessary.

Ingestion: rinse mouth with clean water and drink large quantities of water. Immediately seek medical assistance.

Firefighting measures

AdBlue® is not combustible. NH₃ (ammonia) can be released in the event of fire, causing a risk of poisoning. Firefighting measures must therefore be suited to the surroundings.

Risk of burn injuries, suffocation and poisoning when working on the exhaust system and the components connected to it. Risk of suffocation and risk of poisoning caused by inhalation of gaseous and solid components of the exhaust. Risk of poisoning caused by skin contact with solid components of the exhaust.

	<p>Risk of burn injuries, suffocation and poisoning when working on the exhaust system and the components connected to it. Risk of suffocation and risk of poisoning caused by inhalation of gaseous and solid components of the exhaust.</p> <p>Risk of poisoning caused by skin contact with solid components of the exhaust.</p>	<p>Wear protective clothing and safety glasses. Use the extraction system. Move people out of the hazard area.</p>	<p> Warning</p>
--	---	--	--

Risk of burn injuries

The exhaust system and all components connected to it are very hot during operation and remain so after the engine is switched off. Do not touch hot parts.

Risk of suffocation and poisoning

Exhaust gases may also cause cancer.

At higher concentrations, irritation of mucous membranes and headaches may occur. Carbon monoxide may cause damage to unborn children.

Avoid inhalation of exhaust gases; wear respiratory protection.

Use the exhaust extraction system.

Risk of injury

Risk of injury to the eyes, skin, and respiratory paths due to contact with exhaust residues such as diesel particulates

and diesel soot. To prevent skin contact on hands, wear nitrile gloves.

First aid measures

In the event of inhalation:

Move victim from the hazard area to fresh air without endangering yourself and consult a physician immediately.

After contact with skin:

Immediately wash affected areas of the body with plenty of soap and water. Employees who have experienced skin contact must consult a physician immediately.

After contact with eyes:

Rinse eyes thoroughly with running water for at least ten minutes with the eyelids wide open and contact an eye doctor immediately.

Risk of explosion from explosive gas. Risk of poisoning and caustic burns from swallowing battery electrolyte. Risk of injury through burns to skin and eyes from battery acid or when handling damaged lead-acid batteries

	<p>Risk of explosion from explosive gas. Risk of poisoning and caustic burns from swallowing battery electrolyte. Risk of injury through burns to skin and eyes from battery acid or when handling damaged lead-acid batteries</p>	<p>No fires, sparks, open flames or smoking. Wear acid-resistant gloves, clothing and glasses. Only pour battery acid into suitable and appropriately marked containers.</p>	
--	---	--	---

Potential risks

Risk of explosion

When charging lead batteries with battery electrolyte containing sulfuric acid, a highly explosive oxyhydrogen gas mixture is created that ignites by means of fire, sparks, open flames and smoking.

Risk of injury

The battery electrolyte contains diluted sulfuric acid that causes caustic burns to the skin, eyes and mucous membranes in the event of contact. Bonded electrolyte is just as caustic as liquid electrolyte. Battery electrolyte mist causes caustic burns to the eyes. If inhaled, this can result in caustic burns to the mucous membranes and respiratory paths. In the event of a short circuit from the battery positive to ground, battery terminals and conductive objects causing short circuit, e.g. tool or jewelry (watch band or

ring), become hot in seconds and red hot/liquid metal sprays are released.

Risk of burn injuries

In the event of a short circuit from the battery positive to ground, battery terminals and conductive objects causing short circuit, e.g. tool or jewelry (watch band or ring), become hot in seconds and cause burns.

Risk of poisoning

If battery electrolyte is swallowed, this can result in symptoms of poisoning such as headache, dizziness, stomach ache, respiratory paralysis, unconsciousness, vomiting, caustic burns and cramps. Absorption of lead in the body through contact with leaded components (battery terminals, lead plates in damaged batteries) damages the blood, nerves and kidneys; lead compounds are also toxic for reproduction.

Safety precautions/instructions

- Wear acid-resistant gloves and clothing and safety glasses with side guards.
- Only charge lead batteries in well ventilated rooms with appropriate voltage and appropriate current with approved chargers, taking into account the instructions of the battery and battery charger manufacturers.
- No fire, sparks, open flames and smoking.
- Switch on the battery charger only after connecting to the terminals; switch off the battery charger before disconnecting from the terminals.
- Do not place any conductive objects on the battery and do not wear any conductive jewelry (risk of short circuit).
- Always disconnect the negative terminal first; always connect the positive terminal first (risk of short circuit caused by tool).
- Strict caution is required when handling damaged batteries (removing from vehicle damaged in accident) because of the sharp edges on the fractured housing and escaped electrolyte.
- Keep batteries and battery electrolyte away from unauthorized persons (especially children).
- Only fill liquid battery electrolyte into suitable and appropriately marked containers.
- Only store, transport and install batteries with liquid battery electrolyte horizontally, otherwise battery electrolyte can escape from the degassing holes.
- Ensure that at least one degassing hole at the battery is not sealed, as otherwise overpressure builds that leads to bursting of the battery.
- Ensure proper connection of the degassing line to the degassing hole.
- Ensure the degassing line does not have any kinks and is not blocked at any point.
- Observe the instructions for use for the respective lead batteries and the operator's manual of the vehicle.
- The battery housing may become brittle over time, therefore do not expose the battery to direct sunlight.
- Discharged batteries may freeze and are thereby damaged, therefore always store batteries at a location protected against frost.

Risk of explosion from explosive gas. Risk of poisoning and caustic burns from swallowing battery electrolyte. Risk of injury through burns to skin and eyes from battery acid or when handling damaged lead-acid batteries

First aid measures

Contact with eyes

- Rinse eyes immediately with plenty of water.

Contact with skin

- Remove wet clothing.
- Immediately neutralize battery electrolyte on the skin or clothing with acid neutralizer or soapy water and rinse off with plenty of water.
- Wash off lead on the skin immediately with water and soap.

Inhalation of battery electrolyte mist

- Take the affected person out into the fresh air.

Swallowing battery electrolyte

- Have the person affected drink plenty of water with activated charcoal supplement.

As a general rule, the person affected should consult a medical service or physician after first aid has been rendered.

Fire protection measures

Suitable extinguishing agents

- CO₂ and dry extinguishing agent

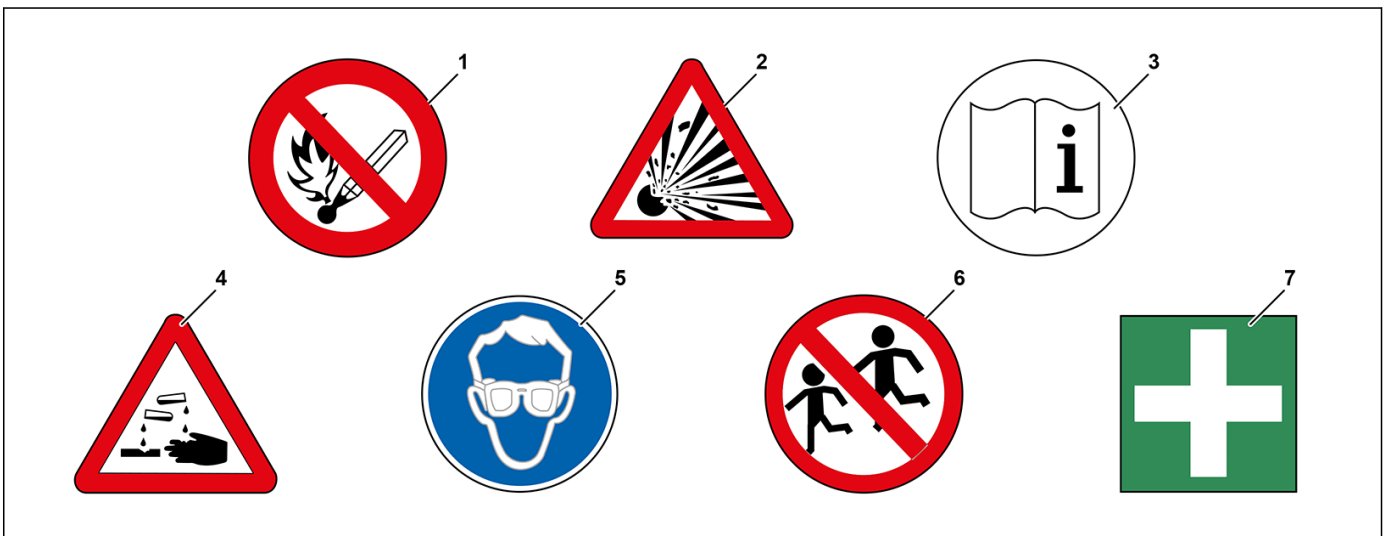

Warning notes for lead batteries with battery electrolyte containing sulfuric acid

- | | | | | | |
|---|---|---|-----------------------|---|-------------------------|
| 1 | No fire, sparks, open flames or smoking | 4 | Risk of caustic burns | 6 | Keep away from children |
| 2 | Risk of explosion | 5 | Wear eye protection | 7 | First aid |
| 3 | Observe operating instructions | | | | |

Risk of injury caused by contact with battery gel when handling damaged lead-gelbatteries

	Risk of injury caused by contact with battery gel when handling damaged lead-gelbatteries	No fires, sparks, open flames or smoking. Wear acid-resistant gloves, clothing and glasses.	Warning
--	--	---	----------------

Potential risks
Risk of poisoning

Swallowing battery gel can cause symptoms of poisoning such as headaches, dizziness, stomach aches, respiratory paralysis, unconsciousness, vomiting, caustic burns and cramps.

The absorption of lead in the body can cause damage to blood, nerves and kidneys; in addition, lead compounds are considered to represent a reproductive hazard.

Risk of injury

The bonded electrolyte set free is just as caustic as a liquid electrolyte that can cause heavy caustic burns to skin and eyes. Strict caution is required when handling damaged lead-gel batteries (e.g. removing from vehicle damaged in accident) because of the sharp edges on the fractured housing and direct contact with the lead plates.

Safety precautions and rules of conduct

- No fires, sparks, open flames or smoking.

- Do not place any tool or other conductive object on the lead-gel battery (risk of short circuit!).
- Disconnect and remove lead-gel batteries for charging.
- Always **disconnect the negative terminal first** and always **connect the positive terminal first** .
- Only switch on the battery charger after connecting to the terminals and switch off before disconnecting.
- Keep lead-gel batteries away from unauthorized persons (especially children).
- Pay attention to instructions for use of the particular lead-gel battery and the operator's manual for the vehicle.
- Wear acid-resistant clothing and safety glasses with side guards.
- Only pour acid gel into suitable and appropriately marked containers.

First aid measures
Contact with eyes

- Rinse out eyes immediately with plenty of water.

Contact with skin

- Remove moistened clothing.
- Immediately neutralize drops of acid or gel on skin or clothing with acid neutralizer or soapy water and rinse off with plenty of water.

Swallowing battery gel

- Have the person affected drink plenty of water supplemented with activated charcoal.

After performing first aid, always consult medical service or a physician.

Fire protection measures
Suitable extinguishing agents

- CO₂ and dry extinguishing agent

Notes on avoiding damage through contamination and foreign objects

	Notes on avoiding damage through contamination and foreign objects		Topical note
--	--	--	--------------

Information on affected component parts

With each maintenance and repair work to the engine as well as to the ancillary assemblies and detachable parts comes the danger of property damage caused by contamination and foreign bodies.

Particularly at risk are:

- Exhaust gas turbocharger
- Hot film mass air flow sensor
- Compressor
- Emission control system
- All components involved in gas exchange

Notes on removal/installation

Openings through which soiling or foreign objects are introduced into the engine, its ancillaries or detachable parts, must be sealed immediately.

For this purpose, suitable, clean covers and plugs or clean, lint-free rags are to be used.



Do not forget to remove all covers, plugs or rags when assembling or when finalizing the work.

This avoids any damage and complaints about engine running characteristics.



Before assembling or finalization work all components are to be checked for soiling, left-over foreign objects and any fluids, and if any are found they are to be removed.

Information on cleaning

For cleaning, use only clean tools and clean, lint-free rags.

Residues of cleaning agents and removed contaminants must be cleared from the engine, ancillary assemblies and detachable parts.



Do **not** use compressed air for removing any soiling. Otherwise, components (e.g. the hot-wire element of the hot film mass air flow sensor) could be damaged or contamination could enter the engine, ancillary assemblies and detachable parts without being noticed.

Notes on use, material properties and handling of AdBlue®

	Notes on use, material properties and handling of AdBlue®		Topical note
--	---	--	--------------

Tasks of AdBlue®

AdBlue® serves to convert nitrogen oxides into water vapor and nitrogen.

Chemical characterization and composition of AdBlue®

The urea content is 32.5%. AdBlue® consists of urea dissolved in demineralized water. AdBlue® is not an additive.

Chemical formula: H₂N-CO-NH₂

Molecular weight (urea): 60.06 g/mol

CAS (Chemical Abstracts Service) no.: 57-13-6

Marking

AdBlue® dispensers are marked with the standard designation ISO 22241 or with the trade designations AdBlue® or Diesel Exhaust Fluid (DEF).

Transport

In vehicles with BlueTEC technology, AdBlue® is carried in a tank.

Physical and chemical properties of AdBlue®

State: Liquid

Color: Colorless, clear, light-yellow

Odor: Slight ammonia odor

pH value: 10 (aqueous solution, 10 %)

Crystallization temperature: -11 °C / 12 °F

Boiling point: 103 °C / 217 °F

Auto-ignition temperature: Not spontaneously inflammable

Density: approx. 1.09 g/cm³ at 20 °C / 68 °F

Viscosity (dynamic): approx. 1.4 mPa*s at 25 °C / 77 °F

Handling contaminated operating fluids

It is essential that AdBlue® be kept separate from other operating fluids, fuels and lubricants such as coolant,

engine oil, transmission oil, fuel, hydraulic fluid and brake fluid and not used in the same containers and collecting bowls. The smallest amounts of AdBlue® can damage thermostats or temperature sensors.

Operating fluids which contain traces of AdBlue® must not be used again.

Handling contaminated AdBlue®

AdBlue® must be checked as per the repair instructions before every fill. Individual components of the exhaust aftertreatment system already react very sensitively with even the smallest traces of contaminants in AdBlue®. When handling AdBlue® it is important, therefore, to always use clean containers and collecting bowls which are only reserved for this purpose. Contaminated AdBlue® must not be used again.

Handling contaminated materials

It is essential that AdBlue® does not come into contact with materials used in the interior of the vehicle. AdBlue® exposed to air passes within just a few hours from a liquid state into the crystalline state and can therefore damage and destroy contaminated surfaces.

Textiles, e.g. the reversible mat in the luggage compartment, which have been fouled with AdBlue® should be alternately cleaned and then rinsed with water several times.

It must be ensured that there are no further traces of AdBlue® in the textiles.

Handling contaminated tools

All tools coming into contact with AdBlue® must be thoroughly cleaned with water immediately after use!

Only fully dried measuring instruments and filling tools should be used so as not to dilute the AdBlue® concentration.

Protecting components when working with AdBlue®

AdBlue® leads to corrosion on electronic components and strong fouling on all other materials. It is therefore necessary to cover up all components in the vicinity over the whole surface with plastic foil when working in circumstances where AdBlue® could leak out.

Storage and packaging

Storage at temperatures between 0°C/32°F and 25°C/77°F should be ensured in order to avoid crystallization occurring



Notes on use, material properties and handling of AdBlue®

in AdBlue®. To avoid deterioration in quality due to contamination, AdBlue® must only be handled in storage and filling systems intended exclusively for AdBlue®. Suitable container materials are alloyed steel, various plastics and plastic coatings in metal containers.

Not to be used are unalloyed steel, aluminum, copper, copper-containing alloys and zinc-dipped steel.

Service life and durability

AdBlue® breaks down during storage into ammonium hydroxide and carbon dioxide and then no longer fulfills the requirements of standard ISO 22241.

If the recommended storage temperature of a maximum of 25°C/77°F is maintained, the AdBlue® will fulfill the requirements of this standard for at least 18 months after manufacture. If this recommended storage temperature is exceeded then this period is reduced. Duration of storage and the temperatures to be used are given as guideline values at the end of the document. At temperatures below -11°C/12 °F, the AdBlue® freezes and becomes solid.

On warming up again the frozen AdBlue® becomes liquid again and can be reused without any loss of quality.

The maximum permissible service life of AdBlue® can be taken from the **MB Specifications for Operating Fluids**.

Disposal and degradability

Disposal of AdBlue®:

When disposing of AdBlue® the legal requirements of the country in which the AdBlue® is used must be observed.

Contaminated packaging/materials:

Packaging which contains residues of AdBlue® is to be handled like the substance itself. Packaging should be emptied as well as possible; it can then be reused after appropriate cleaning with water.

Constant ambient conditions

Storage temperature in °C/°F - Durability in months

≤10 / 50 - 36

≤25 / 77 - 18

≤30 / 86 - 12

≤35 / 95 - 6

>35 / 95 - --

Information on preventing damage to electronic components due to electrostatic discharge

	Information on preventing damage to electronic components due to electrostatic discharge		<div style="background-color: #0056b3; color: white; padding: 2px;">Topical note</div>
--	--	--	--

Electrostatic charge

Every contact and every physical separation of materials or every movement of solids, liquids or charged particle-containing gases can generate electrostatic charge. Plastics generally produce the highest electrostatic charge.

We come across electrostatic charge or discharge in lots of everyday situations, e.g. with:

- Combs
- Walking on carpets or plastic floors
- Putting on and taking off textiles with synthetic fiber content
- Disembarking from the vehicle
- Contact between various electrostatically chargeable packaging materials in shelves or in the transport container

The resulting electrostatic discharge (**Electrostatic Discharge (ESD)**) can be so strong that a small electric shock is detected. Even the smallest discharges which people cannot detect can cause lasting damage to electronic components and control units.

Effects and consequences of ESD

Electronic components and control units are very sensitive to ESD. The damage is often not immediately obvious, but becomes apparent some time later. In order to avoid failures and damage due to ESD in vehicle electronics, various procedures and safety precautions must be taken into account and followed.

Risk of damage arises during the transportation, handling, testing, removal and installation of electronic components during production and repair work.

The following electronic components listed as an example can be damaged by ESD:

- Airbag components
- Control units, in particular their bus connections
Controller Area Network (data bus/CAN bus) (CAN),
Local Interconnect Network (LIN) etc.
- Sensors
- Mechatronic component parts (actuators etc.)
- Antenna amplifier
- Receivers and displays (Radio, TV, GPS, telephone etc.)

Modes of behavior and safety precautions

- Electrostatic discharge of the technician (e.g. by briefly touching the vehicle body).
- Suitable clothing, e.g. made of cotton.
- Wear ESD safety shoes with conductive soles.
- Keep workplace clean and clear away unnecessary objects such as conventional plastics.
- Special antistatic seat cushion protectors should be used when performing repair work inside a vehicle.
- Leave replacement parts in the original packing for as long as possible, do not tear open seals but cut them open carefully.
- The ESD workplace must conform to the ESD guidelines.

- The operation-specific documentation in the WIS must be observed and the specified special tools and/or workshop equipment must be used in each case.
- Before unpacking, discharge ESD protective packaging at the ESD workplace.
- Avoid any contact with electrostatic chargeable materials such as, e.g. polyethylene, PVC, styrofoam.
- Use only original packaging or specially labeled and defined packaging and transport materials.
- Electronic components which have been removed must be put down on an ESD workplace.
- Electrical connectors on electronic component parts and in the wiring harness should be touched by their housing only. Do not touch pins or contacts!
- Electronic components must be installed before they are connected so that potential equalization with the body can take place.
- Shelves and worktables must stand directly on the floor, there must not be any insulating materials between the base of the shelves/feet and the floor. If the above mentioned insulators cannot be removed, the shelves and work tables must be grounded (e.g. low-resistance electrical connection/line from metal shelf to a coolant pipe).
- Do not put down conductive containers/crates when insulated,
(e.g. on a wooden pallet), as otherwise potential equalization will not take place.

Information on preventing damage to electronic components due to electrostatic discharge

- Do not place control units and electronic components removed from the vehicle on electrostatically chargeable materials, such as PE, PVC, styrofoam. The

electrostatic charge is transferred to the control unit or electronic component. An ESD service kit or a connected ESD table mat must be used.

Training

It is strongly recommended that every company has an ESD officer trained in accordance with DIN EN 61340-5-1.

The ESD officer can carry out staff training courses.

The aim of the training measures is to communicate the main problems and effects of ESD to staff:

- Discharge generation
- Reasoning for safety precautions
- Effects and consequences of ESD
- ESD rules of conduct and safety precautions

Return of electronic components in warranty and goodwill cases

When returning electronic components it is absolutely essential to observe the procedure and safety precautions listed. The original fault may be falsified or hidden by electrostatic charge/discharge.

This can lead to distorted fault symptoms in the case of the fault analysis of the component concerned.



Notes on carrying out repair work in the vehicle interior

	Notes on carrying out repair work in the vehicle interior		Topical note
--	---	--	--------------

In order to prevent soiling or damage, the following information must be observed:

- Before starting repairs in the vehicle interior, the corresponding protective covers must be provided in the repair area for the floor coverings, seats, steering wheel, etc. to prevent them from becoming dirty.
- Persons performing work in the vehicle interior should ensure they have clean work clothes, clean shoes and clean hands.

- When removing bulky or difficult to handle parts (e.g. bench seat, roof lining, instrument panel etc.), always work with aid of at least a second person.
- Do not use dirty or unapproved tools. This prevents any, e.g. scratching or crazing of interior parts etc.
- Always place removed interior parts on a clean and soft surface.

Further information:

- Repair or replace damaged interior parts (particularly mounts such as retaining clips, Velcro fasteners etc.).
- When installing interior parts at the intended locations, install insulation material and/or protective foils, or, replace insulation material/protective foils as required in order to dampen vibrations and noise.
- Many equipment parts in the area of the vehicle interior have been installed or made specifically to the

customer's request, and cannot be replaced easily if damaged or soiled; for this reason, utmost care must be ensured when carrying out operations in the vehicle interior.

- Remove any dirt present with cleaners approved by Daimler and suitable for corresponding surfaces. When doing so, where possible, the compatibility of the cleaning agent should be tested at a concealed area of the part to be cleaned.



Lift point locations



When performing procedure on a vehicle lift



Vehicle must be in a ready to lift position before procedure is started.



Read the operating instructions for the vehicle lift.

Lift mounting points on the vehicle in the area of the front axle

- 01 spring clamp plate
- 02 longitudinal member
- 08 bracket
- 011 arm of hydraulic lift
- 012 support plate
- 013 long support plate
- 017 support drift

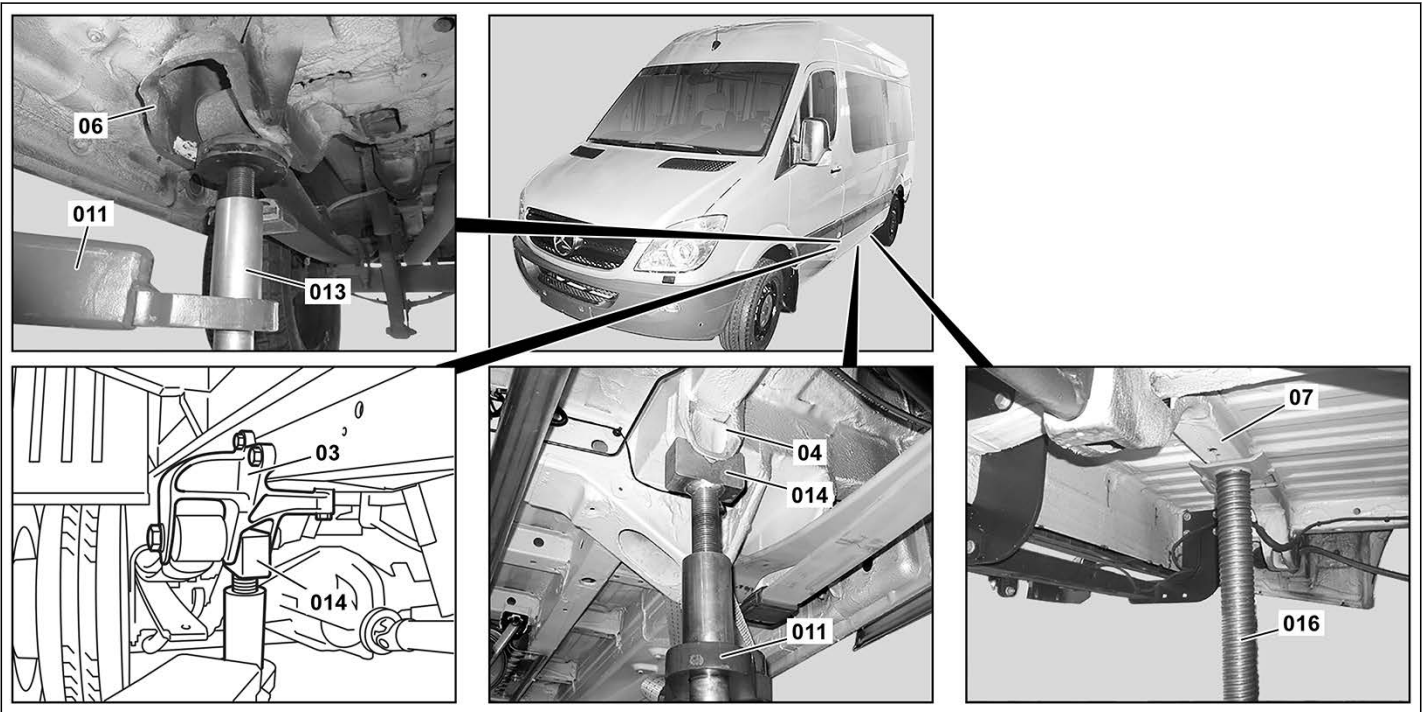
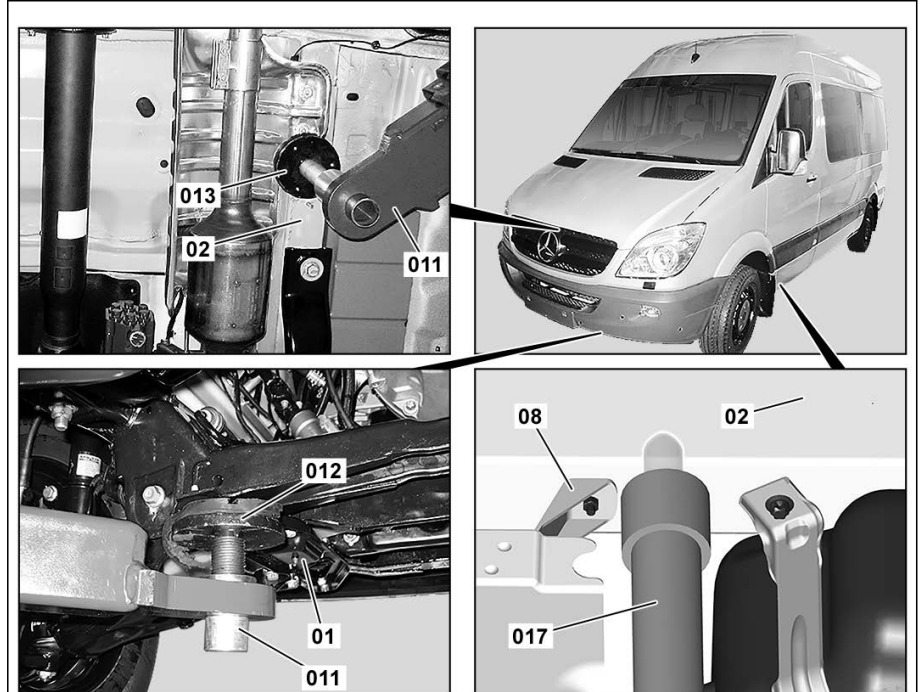

Lift mounting points on the vehicle in the area of the rear axle

- | | | |
|------------------------------|---------------------------|-------------|
| 03 front rear spring bracket | 07 crossmember | 014 v-block |
| 04 longitudinal member | 011 arm of hydraulic lift | 016 prop |
| 06 front rear spring bracket | 013 long support plate | |



Picture reference	Pick-up point	Information
03	Support at rear to front rear spring bracket.	
04	Rear support at longitudinal member.	- If possible, always support at rear Install at longitudinal member (4).
06	Install on front rear spring bracket.	
012	Support plate.	- For front support to spring clamp plate (1). Unscrew support plate (012) at right and left an equal distance. - In vehicles with vehicle lift support point at integral carrier (5).
013	Long support plate.	- For front support at longitudinal member (2) and support at front rear spring bracket (6). Can be used alternatively to front support to spring clamp plate (1). Pull out long support plates (013) at right and left an equal distance. - In vehicles without a vehicle lift support point at the integral carrier (5) in the vicinity of the inner mounts of the semi-trailing arms.
014	V-block	- For rear support at front rear spring bracket (3) and rear support at longitudinal member (4). Pull v-block (014) at right and left rear out an equal distance.
016	Ram	- Vehicles with heavy bodies and panel vans/crewbuses with a long wheelbase at the crossmember (7) should be supported with a prop (016).
017	Support drift	- With soundproofing Ensure that support drift (017) does not make contact with bracket (8) of rear soundproofing. If necessary, loosen bracket (8), push towards the front as far as possible and retighten it. Otherwise the brackets (8) of the rear soundproofing and the longitudinal members may be damaged. - For front support to longitudinal member (2). Unscrew support drift (017) at right and left an equal distance.

Secure vehicle on lift.

Heavily loaded vehicles, vehicles with a heavy body and vehicles with unfavorable load distribution must be secured.

Otherwise these may fall.

Instructions for driving onto ramps



When performing procedure on ramps.



Vehicle must be driven onto ramps before procedure is started.



Race Ramps are available for order from MBUSA Standard Service Equipment Program (SSEP): www.mbusassep.com Part number: 784-RR-HTVR-RC-KIT

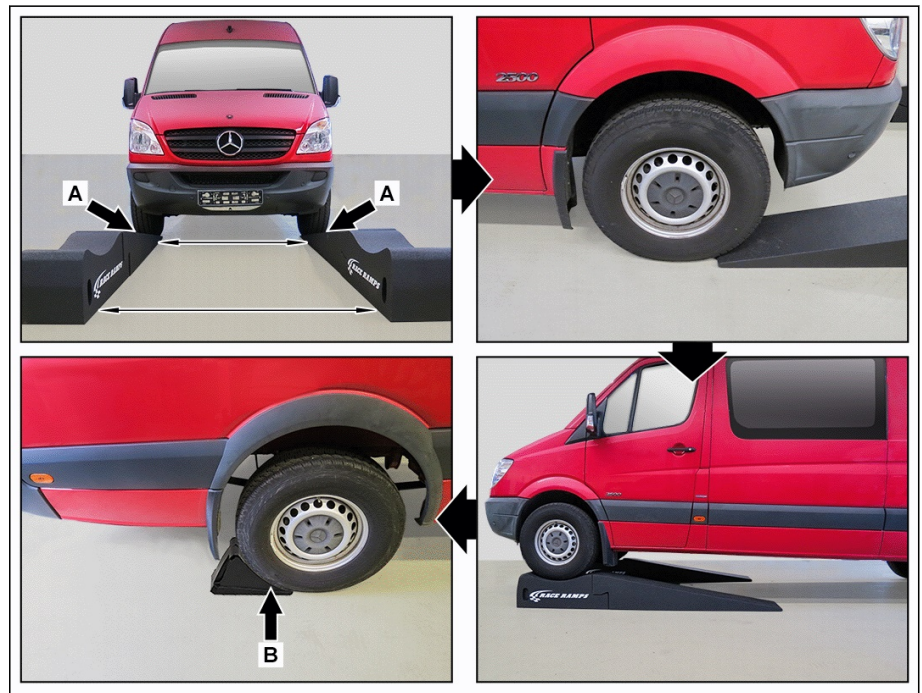

Read the operating instructions provided by the manufacturer of the ramps. Since these are ramps that have not been built or tested by Mercedes Benz, no information can be given on safety. Mercedes Benz excludes all liability when using these ramps.

- 1 Place the vehicle on a clean, firm and level surface.
 Make sure that there is enough space to the front.
- 2 Place ramps in the middle (arrows A) of the front wheels.
 The ramps must be aligned parallel to each other.
- 3 Drive the vehicle onto the ramps until it is positioned in the end position specified by the manufacturer of the ramps.
 Drive the vehicle slowly and at a constant speed onto the ramps. Otherwise the vehicle may be damaged.
 If necessary, include a helper to instruct you.
- 4 Secure the vehicle against rolling away.
 For example, by applying the parking brake and by placing a wheel chock (arrow B) on the rear wheels.

Initial Quick Test

- 1 Switch off the ignition.
- 2 Disconnect Geotab, Omni Track, Navigation or any aftermarket devices that are connected to the X11/4 diagnostic socket.

- 3 Open the hood.



Verify Vehicle Identification Number (VIN) on vehicle VIN markings matches VIN on Repair Order exactly. Correct VIN errors on RO before RO is closed at your dealership.

- 4 Connect the battery charger to the vehicle's jump posts as indicated. (arrows)



A sufficient power supply to the vehicle on-board system must be ensured throughout the entire work procedure.

Otherwise any undervoltage that occurs may damage the control units.



Do not connect the battery charger to the auxiliary battery in the engine compartment.



Follow the operating instructions for the battery charger.



Use a Mercedes-Benz recommended battery charger to ensure an adequate voltage supply (min. 12.5 V) is provided for the on-board electrical system battery.

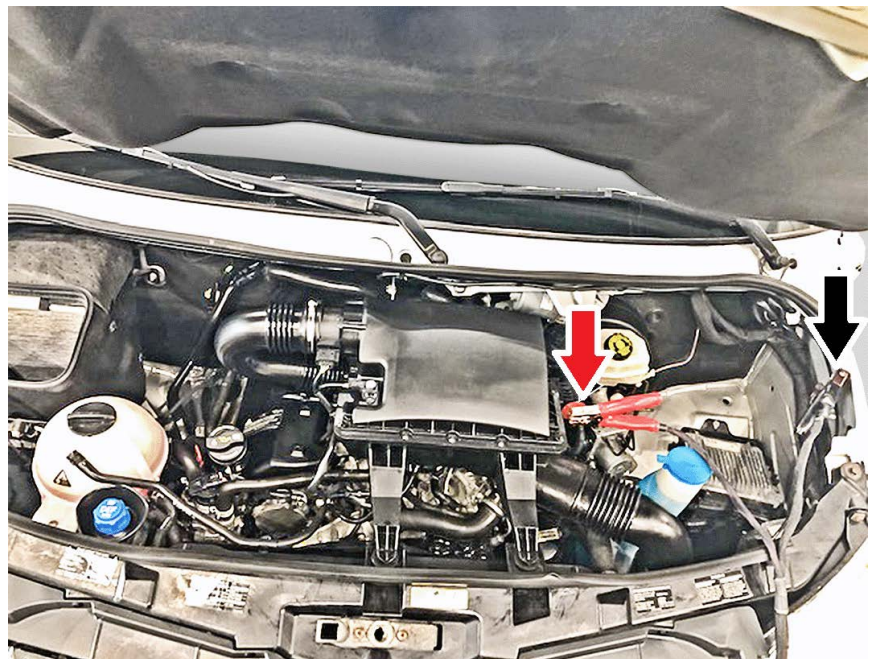

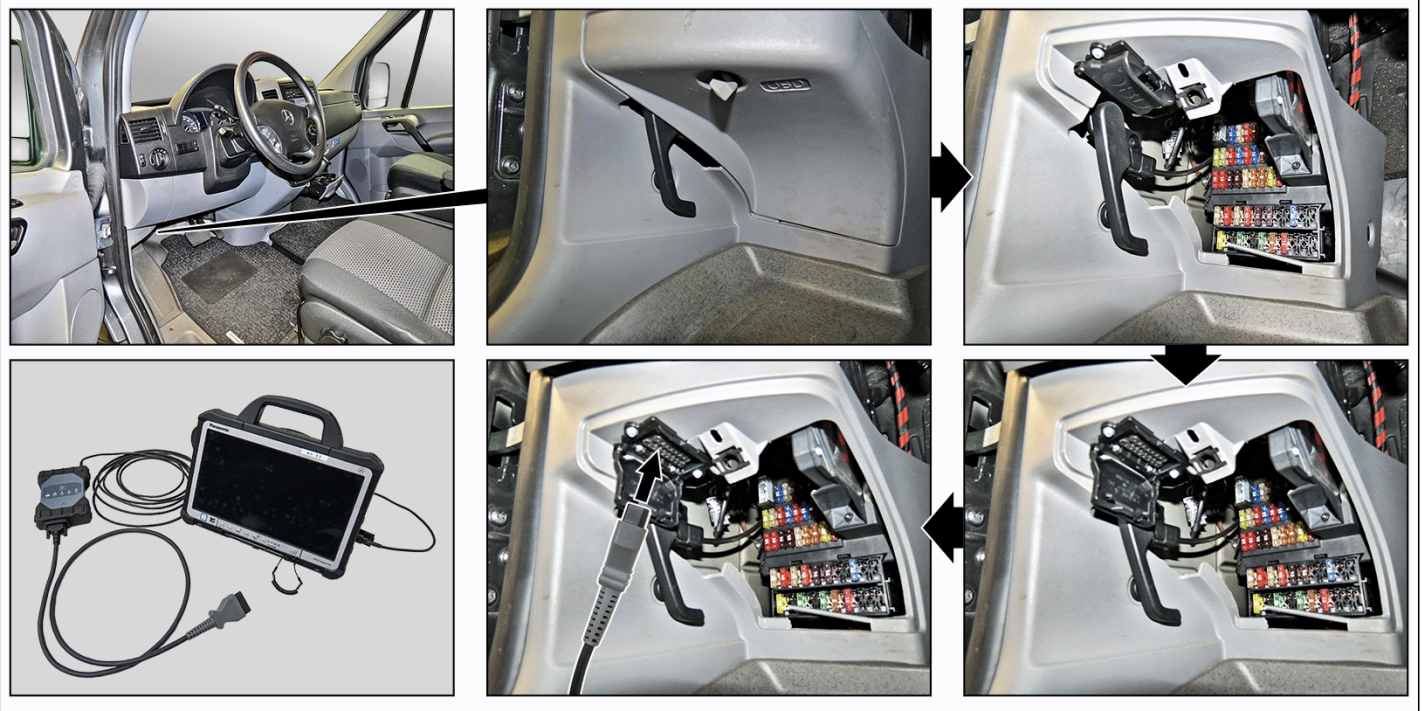

- 5 Ensure XENTRY is fully updated with the latest release and all available add-ons.
- 6 Connect the diagnostic system. Make sure that the OBD2 connection cable is connected directly to the factory X11 / 4 diagnostic socket and not via an adapter cable.
- 7 Switch on the ignition.
i
The diagnostic system remains connected to the vehicle throughout the work procedure! Do not disconnect the diagnostic system's online connection.
- 8 Start the diagnostic system.
- 9 Run XENTRY and perform Quick Test. Upload Initial Quick Test print-out to paperless pXD.
i
Ensure Vehicle Identification Number (VIN) readout in XENTRY/DAS matches vehicle VIN markings exactly. If not, please open a PTSS case with photos of VIN markings and XENTRY/DAS Quick Test showing VIN readout.
i
Pre-existing faults causing a Check Engine Light must be evaluated. Reference Pre-Inspection Notes on page 2.
i
The procedure via the diagnostic system is shown on the following pages.
- 10 Perform Emissions Modification Pre-Inspection.

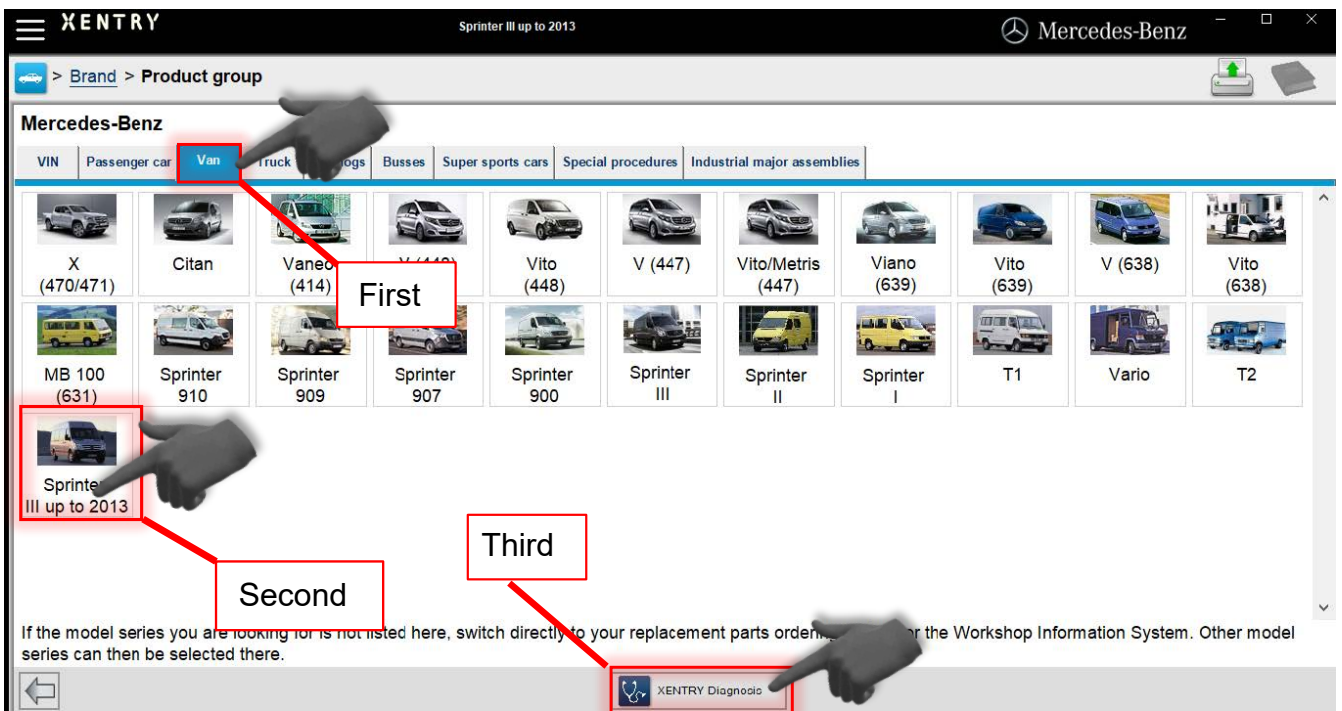



XENTRY Sprinter III up to 2013 Mercedes-Benz

> Brand > Product group > Vehicle

Model

Please select a vehicle model designation from product group 'Sprinter III up to 2013'.

i You can now start XENTRY Diagnosis or select more vehicle data for other applications.

All

906.111 - 209/11/13/15 CDI FHS, 209/210/213/216 CDI FHS, 218 CDI FHS, 219 CDI FHS
906.113 - 209/11/13/15 CDI FHS, 209/210/213/216 CDI FHS, 216 FHS, 218 CDI FHS, 219 CDI FHS, 224 FHS
906.131 - 309/11/13/15/16 CDI FHS, 309/310/313/316 CDI FHS, 311/315 CDI FHS, 318 CDI FHS, 319 CDI FHS
906.132 - 309/11/13/15/16 CDI FHS, 309/310/313/316 CDI FHS, 318 CDI FHS, 319 CDI FHS
906.133 - 309/11/13/15/16 CDI FHS, 309/310/313/316 CDI FHS, 311/315 CDI FHS, 313/316 CDI FHS, 316 FHS, 318 CDI FHS, 319 CDI FHS, 324 FHS
906.134 - 309/11/13/15/16 CDI FHS, 309/310/313/316 CDI FHS, 318 CDI FHS, 319 CDI FHS
906.135 - 309/11/13/15/16 CDI FHS, 309/310/313/316 CDI FHS, 311/315 CDI FHS, 313/316 CDI FHS, 316 FHS, 318 CDI FHS, 319 CDI FHS, 324 FHS
906.136 - 309/11/13/15/16 CDI FHS, 309/310/313/316 CDI FHS, 318 CDI FHS, 319 CDI FHS
906.153 - 411/15, 509/11/15 CDI FHS, 413/16, 509/510/13/16 CDI FHS, 418/518 CDI FHS, 419/519 CDI FHS, 511/515 CDI FHS, 513/516 CDI FHS, 516 FHS, 518 CDI F
906.155 - 411/15, 509/11/15 CDI FHS, 413/16, 509/510/13/16 CDI FHS, 418/518 CDI FHS, 419/519 CDI FHS, 511/515 CDI FHS, 513/516 CDI FHS, 516 FHS, 518 CDI F
906.211 - 209/11/13/15 CDI FHL, 209/210/213/216 CDI FHL, 218 CDI FHL, 219 CDI FHL
906.213 - 209/11/13/15 CDI FHL, 209/210/213/216 CDI FHL, 216 FHL, 218 CDI FHL, 219 CDI FHL, 224 FHL
906.231 - 309/11/13/15/16 CDI FHL, 309/310/313/316 CDI FHL, 311/315 CDI FHL, 318 CDI FHL, 319 CDI, 319 CDI FHL
906.233 - 309/11/13/15/16 CDI FHL, 309/310/313/316 CDI FHL, 311/315 CDI FHL, 313/316 CDI FHL, 316 FHL, 318 CDI FHL, 319 CDI FHL, 324 FHL

XENTRY Diagnosis Continue

DAS English

Vehicle 906 Control unit

NOTES

Information on preventing damage to electronic components due to electrostatic discharge :

- The safety information and descriptions listed in Help (F6) MUST be observed. ⚠

General test conditions :

- Use only cable with fuse for bridges.
- Each time after replacing a component, always carry out a component test.
- A component test should be carried out in order to ensure the correct connection of separated plug connections (electric or pneumatic).
- When processing a fault code, a fault code may be generated by a test step which is interrogated in a YES/NO cell.
- This step may temporarily result in other fault codes which should be ignored.
- Only generate counterfault by short circuit and open circuit if this is expressly requested in the decision tree.

Safety note :

- Pay attention to the safety notice 'AS 58.40-Z-0001-01A' on the use of the diagnostic units in mobile applications.

General information :

- The data read out of the control units refer to specific events or system statuses and serve as a basis for narrowing down the source of the defect. The data may include a tolerance and it may therefore not necessarily be possible to link them to a certain event, location or time.

ESC F1 F2 Forward F6 F11

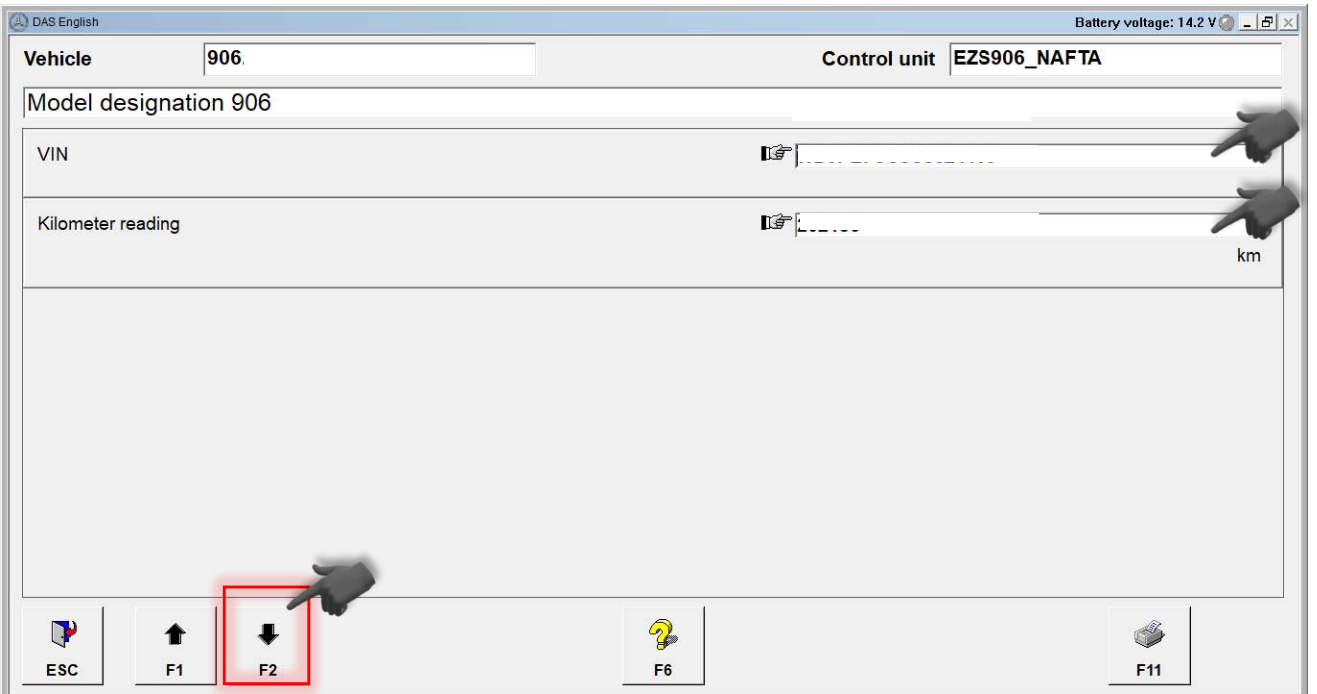
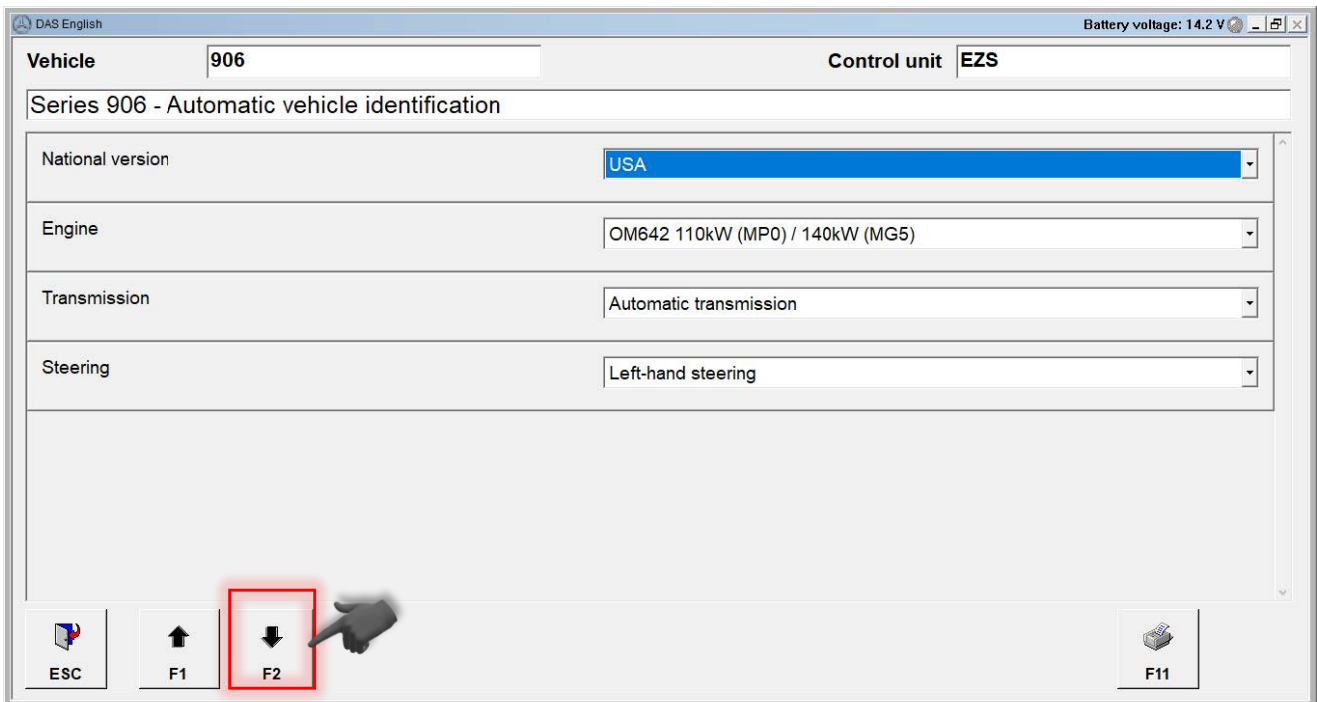

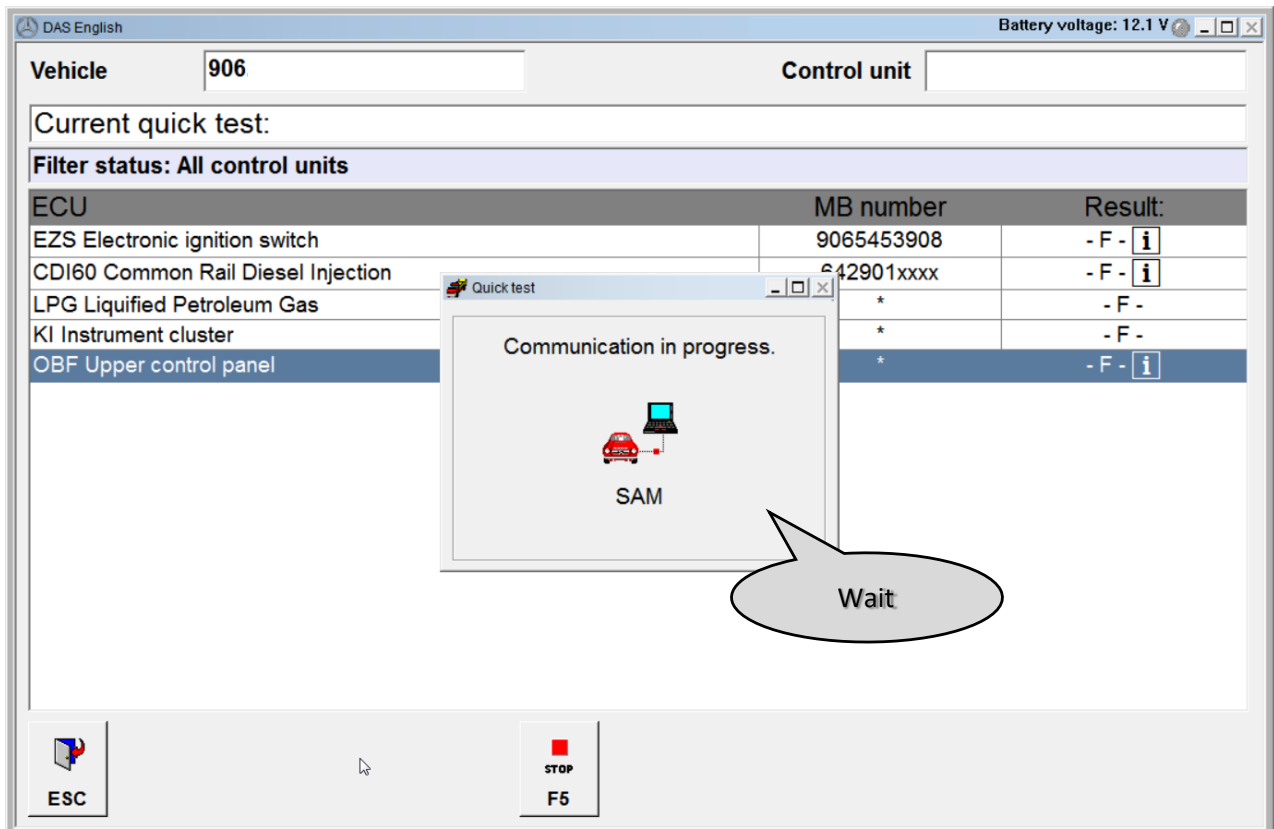
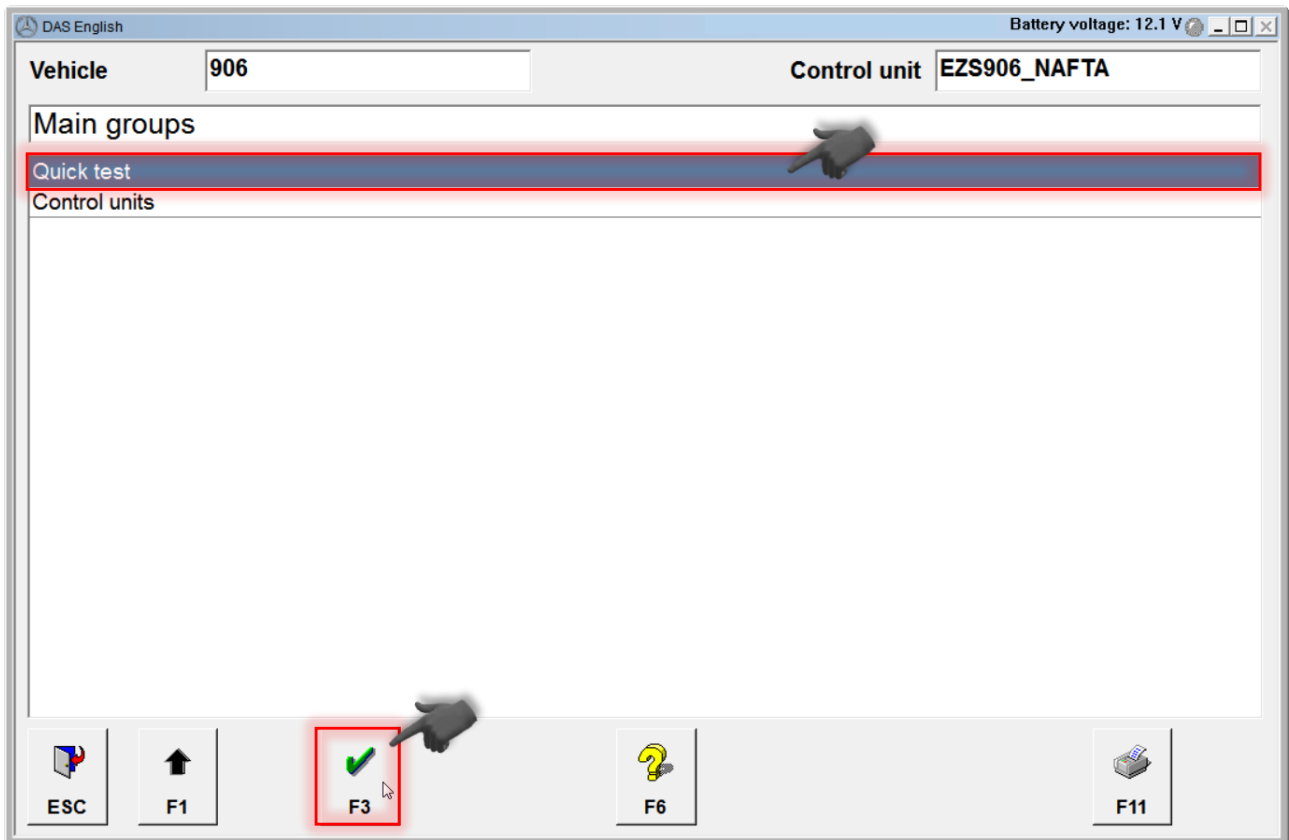



DAS English Battery voltage: 12.1 V

Vehicle: 906 Control unit:

Current quick test:

Filter status: All control units

ECU	MB number	Result:
CDI60 Common Rail Diesel Injection	642901xxxx	- F -
SCR Control unit AdBlue®	*	- ✓ -
FSCM Fuel pump	*	- F -
EZS Electronic ignition switch	9065453908	- F -
KI Instrument cluster	*	- F -
OBF Upper control panel	*	- F -
SAM Signal acquisition and actuation module	*	- F -
TSG Door control module front driver side	*	- F -
AAG2 Trailer connection unit	*	- F -
DBE Overhead control panel	*	- F -
ENR Electronic level control	*	- F -
ESP Electronic stability program	*	- F -
KE Keyless Entry	*	- F -
KLA Automatic air conditioning/automatic temperature control	*	- F -
LPG Liquefied Petroleum Gas	*	- F -

ESC F1 F3 F4 F5 F6 F8 F9 F11

DAS English Battery voltage: 12.1 V

Vehicle: 906 Control unit:

Current quick test:

Filter status: All control units

ECU	MB number	Result:
CDI60 Common Rail Diesel Injection	642901xxxx	- F -
SCR Control unit AdBlue®	*	- ✓ -
FSCM Fuel pump	*	- F -
EZS Electronic ignition switch	9065453908	- F -
KI Instrument cluster	*	- F -
OBF Upper control panel	*	- F -
SAM Signal acquisition and actuation module	*	- F -
TSG Door control module front driver side	*	- F -
AAG2 Trailer connection unit	*	- F -
DBE Overhead control panel	*	- F -
ENR Electronic level control	*	- F -
ESP Electronic stability program	*	- F -
KE Keyless Entry	*	- F -
KLA Automatic air conditioning/automatic temperature control	*	- F -
LPG Liquefied Petroleum Gas	*	- F -

Printer: \\SEDCP...e065.corpintra.net\Printer000

Printout of test step
Screen printout
Printing of the context for hotlines
Initial quick test log (English)
Final quick test log (English)
Print session protocols.

File format:
Colors
 Black and White

Page view Print Abort

Name file: QT 1

Second

First

Third

Fourth

ESC F1 F3 F4 F5 F6 F8 F9 F11

Pre-existing faults causing a Check Engine Light must be evaluated. Reference Pre-Inspection Guide on page 2.



Pre-Inspection Special Procedure

DAS English Battery voltage: 12.1 V

Vehicle: 906 Control unit: []

Current quick test:

Filter status: All control units

ECU	MB Number	Result:
CDI60 Common Rail Diesel Injection	642001xxxx	- F - i
SCR Control unit AdBlue®	*	- ✓ -
FSCM Fuel pump	*	- F - i
EZS Electronic ignition switch	9065453908	- F - i
KI Instrument cluster	*	- F -
OBF Upper control panel	*	- F - i
SAM Signal acquisition and actuation module	*	- F - i
TSG Door control module front driver side	*	- F - i
AAG2 Trailer connection unit	*	- F - i
DBE Overhead control panel	*	- F - i
ENR Electronic level control	*	- F - i
ESP Electronic stability program	*	- F - i
KE Keyless Entry	*	- F - i
KLA Automatic air conditioning/automatic temperature control	*	- F -
LPG Liquefied Petroleum Gas	*	- F -

Toolbar: ESC, F1, **F3**, F4, START F5, F6, F8, F9, F11

DAS English Battery voltage: 14.2 V

Vehicle: 906 Control unit: CDI60

CDI60 Common Rail Diesel Injection (OM642 EPA13)

I herewith confirm that I have read the safety notes.

- ⚠ Safety information for work on a running engine
- ⚠ Safety notes for fuel

Toolbar: ESC, F1, **F3 Selection**, F6, F11

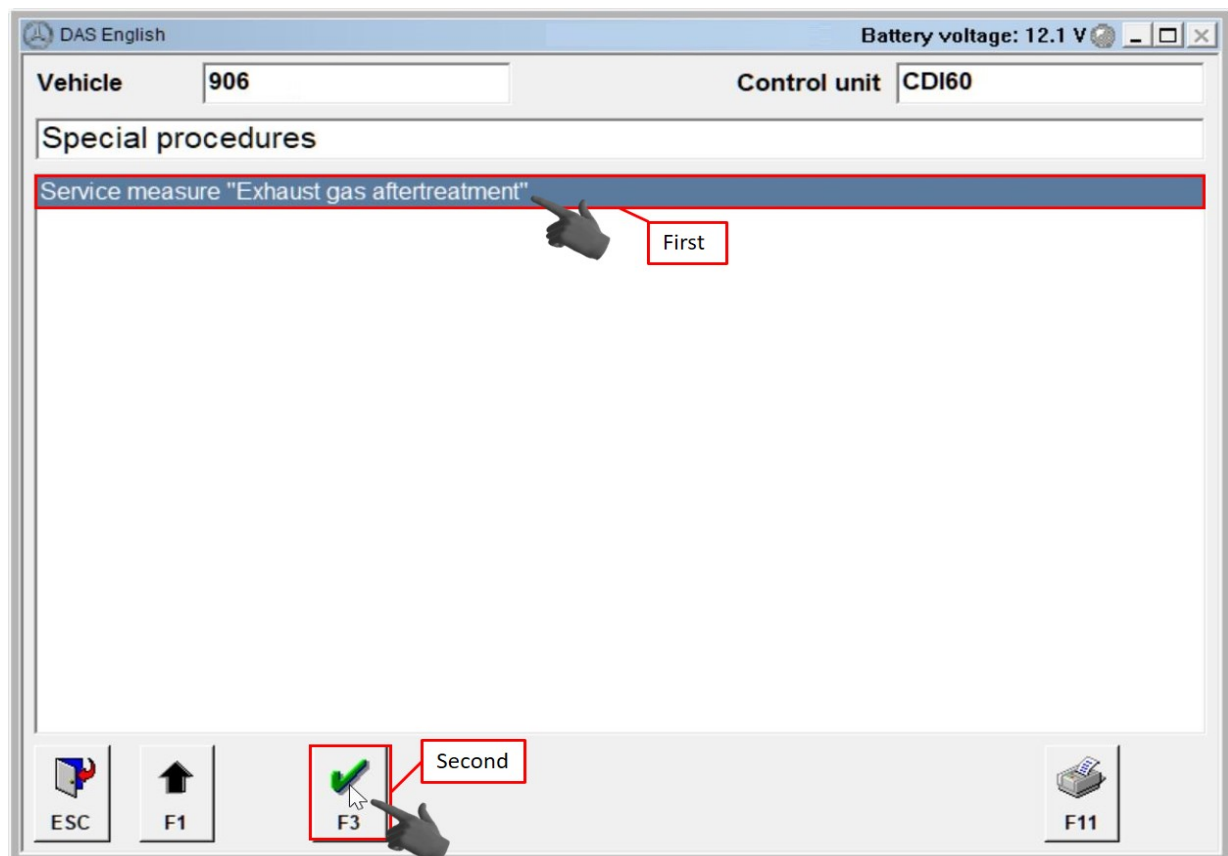
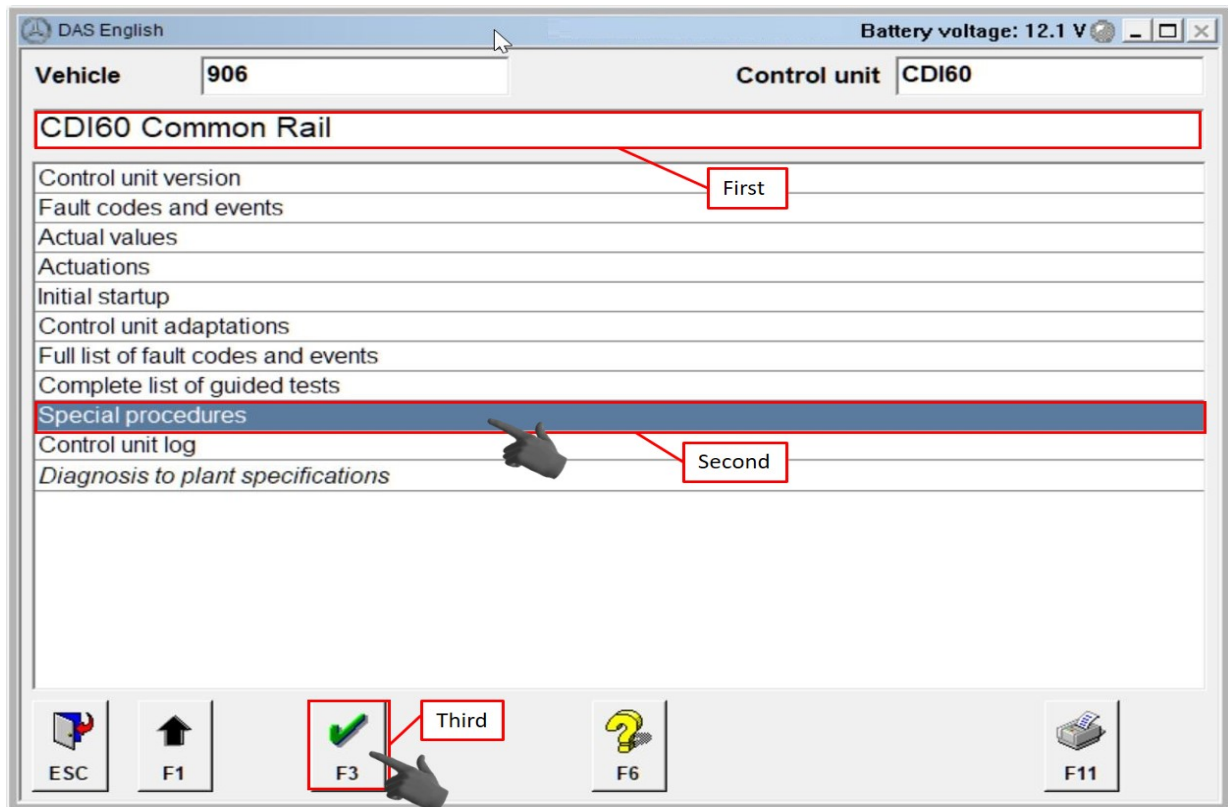

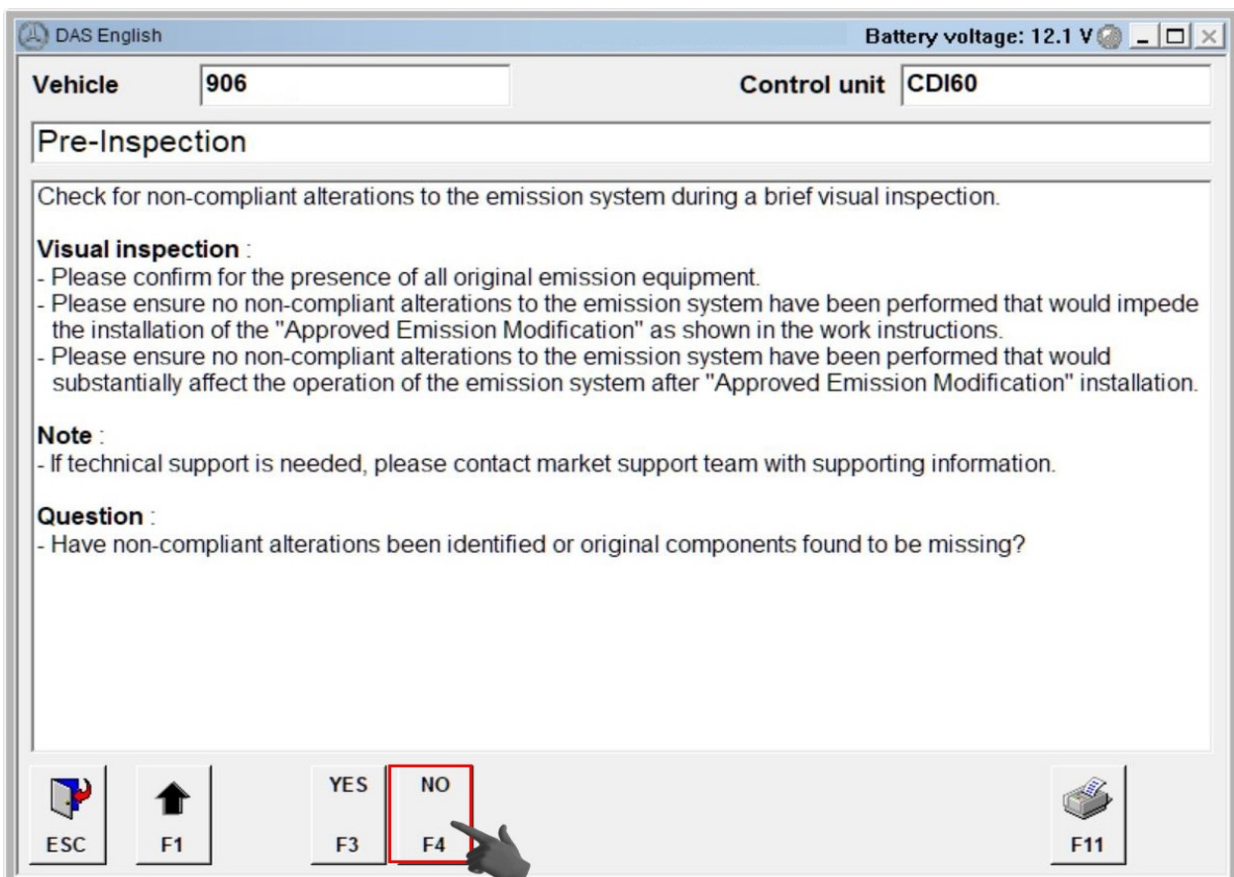
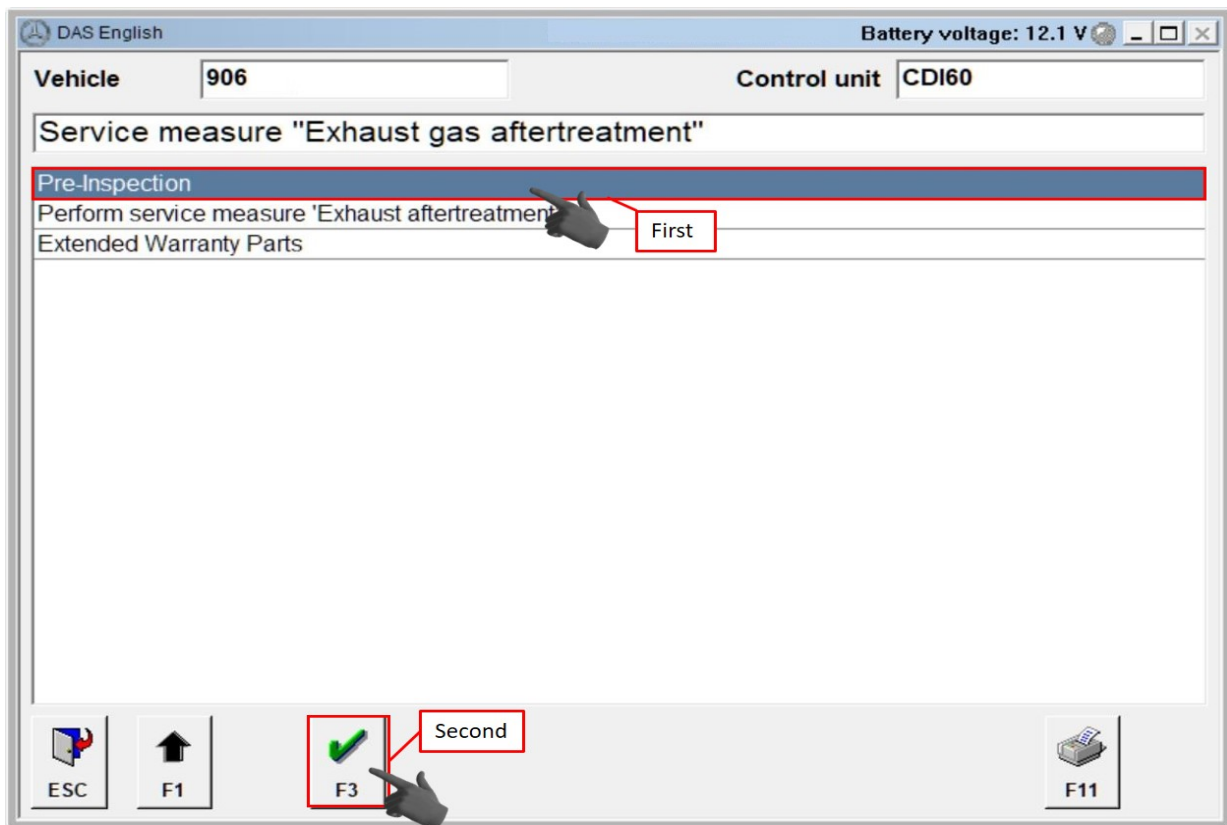

If Non-Compliant alterations are found, reference the Pre-Inspection Guide on page 2 for next steps.

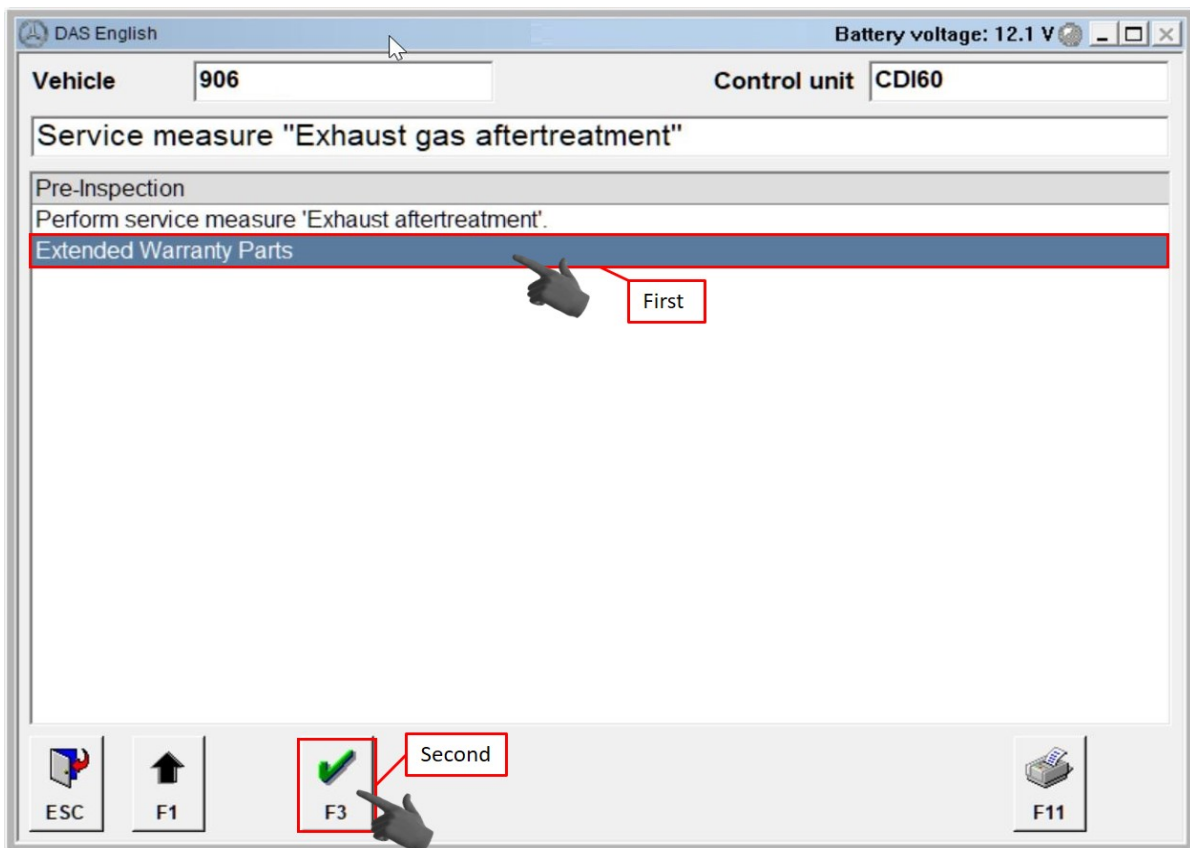
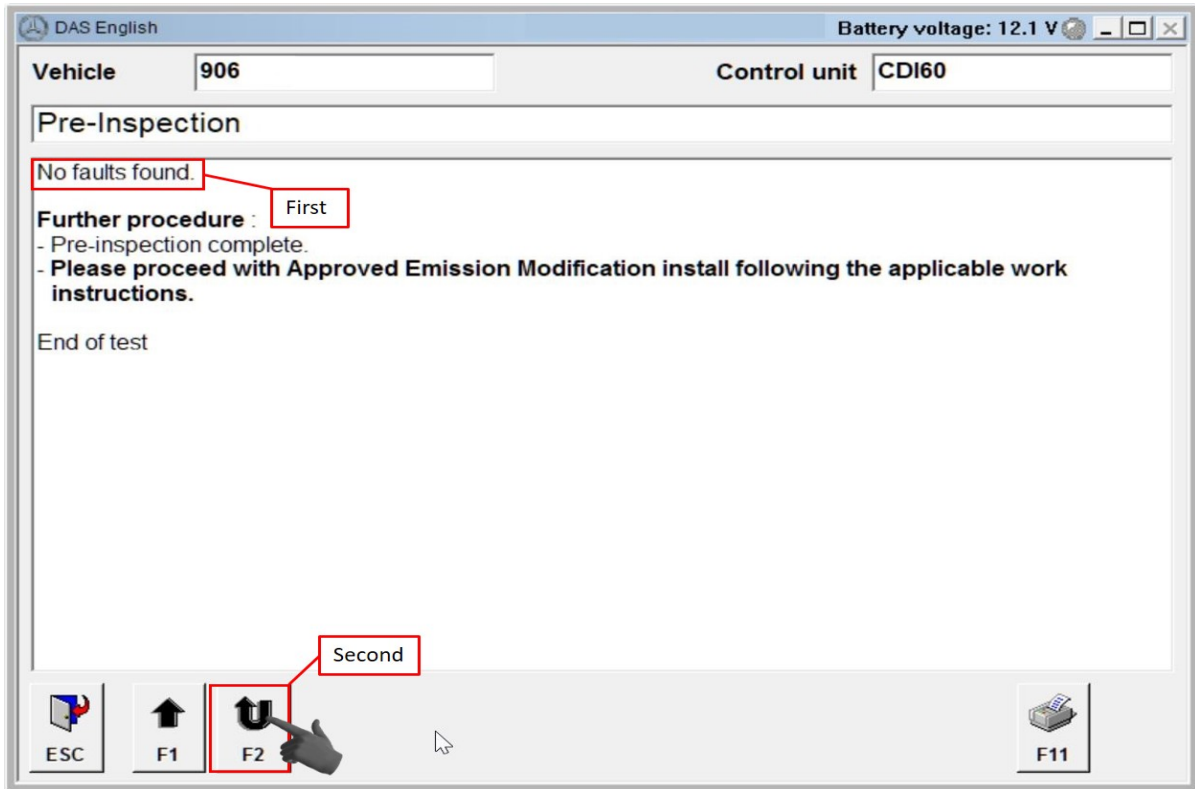

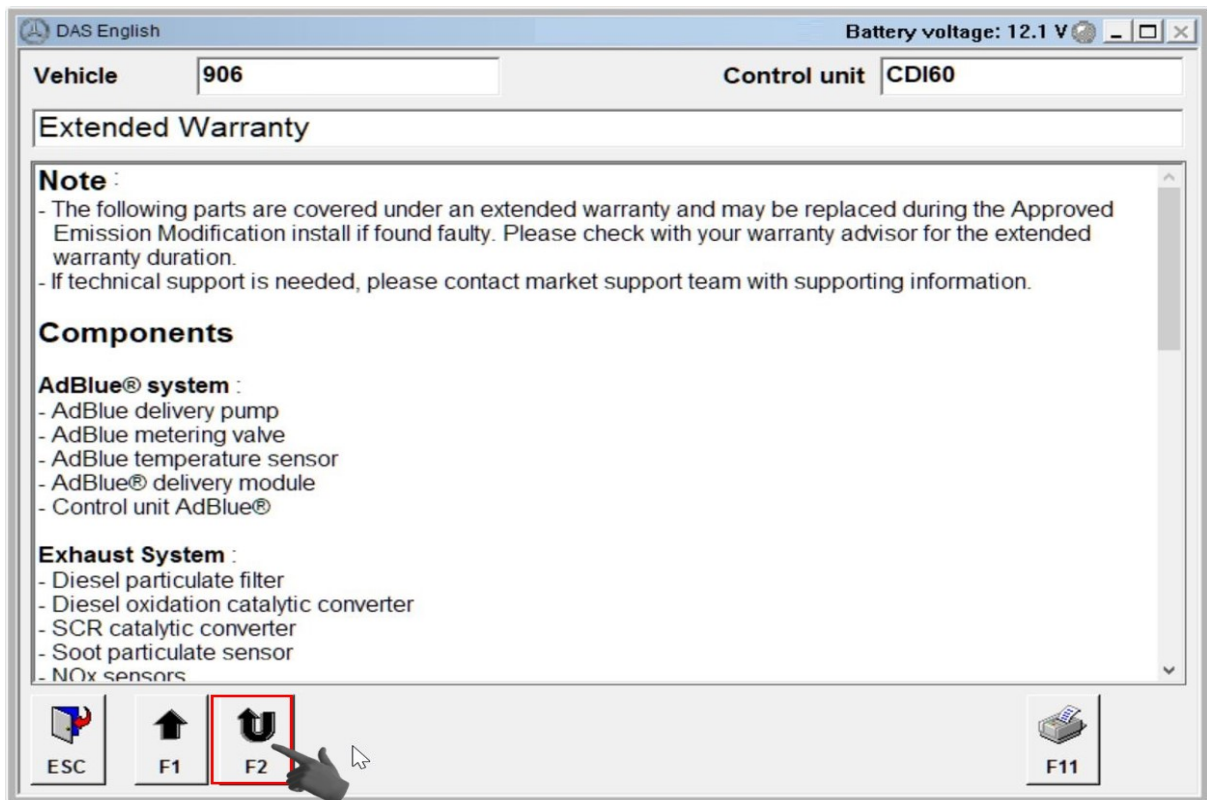

11 End the DAS session.

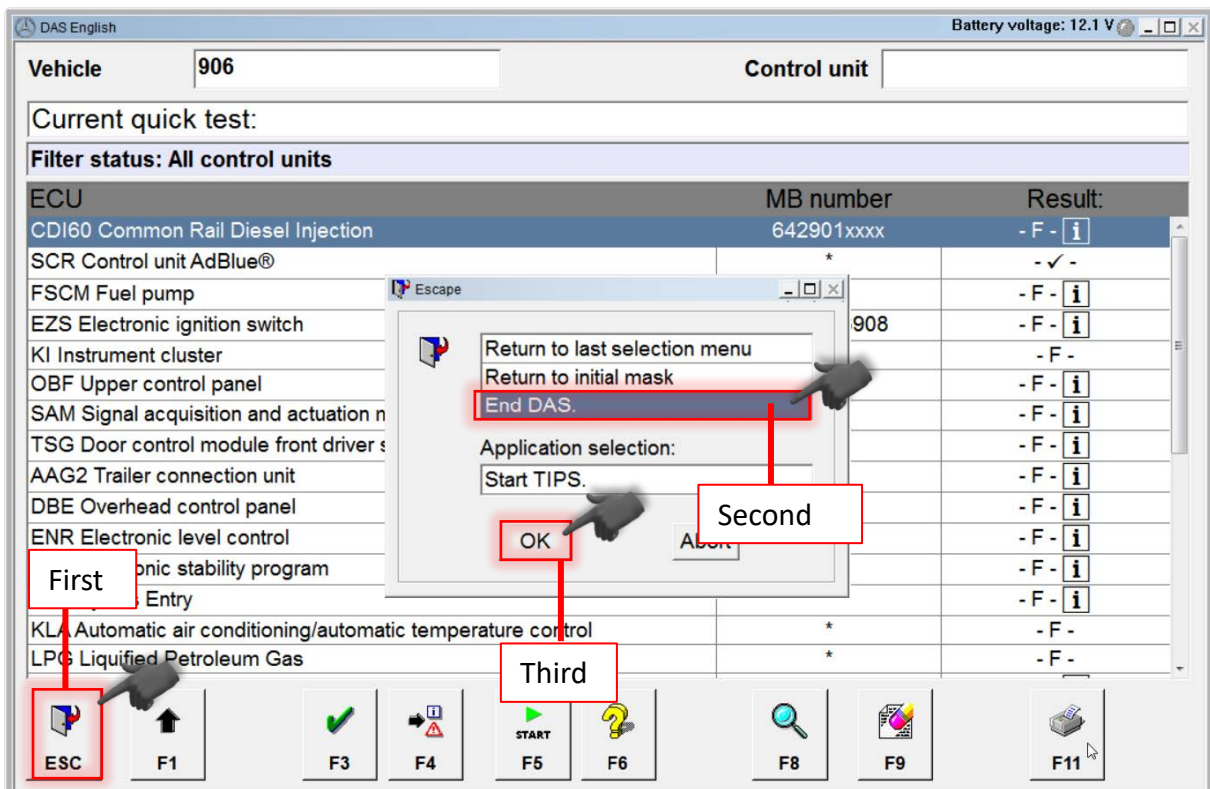

12 Switch off the ignition.

13 Disconnect the diagnostic system.

14 Disconnect battery charger.

Replacement of AEM Parts

- 15 Spray penetrating oil on the threads of the NO_x sensor upstream of SCR catalytic converter (3), clamp (16), clamp (21), thread of the exhaust gas temperature sensor (12) and clamp (15), as shown.



Exhaust system should be cold in order to carry out the next steps. This avoids injuries.



Observe the wait period and details provided by the manufacturer of the penetrating oil!

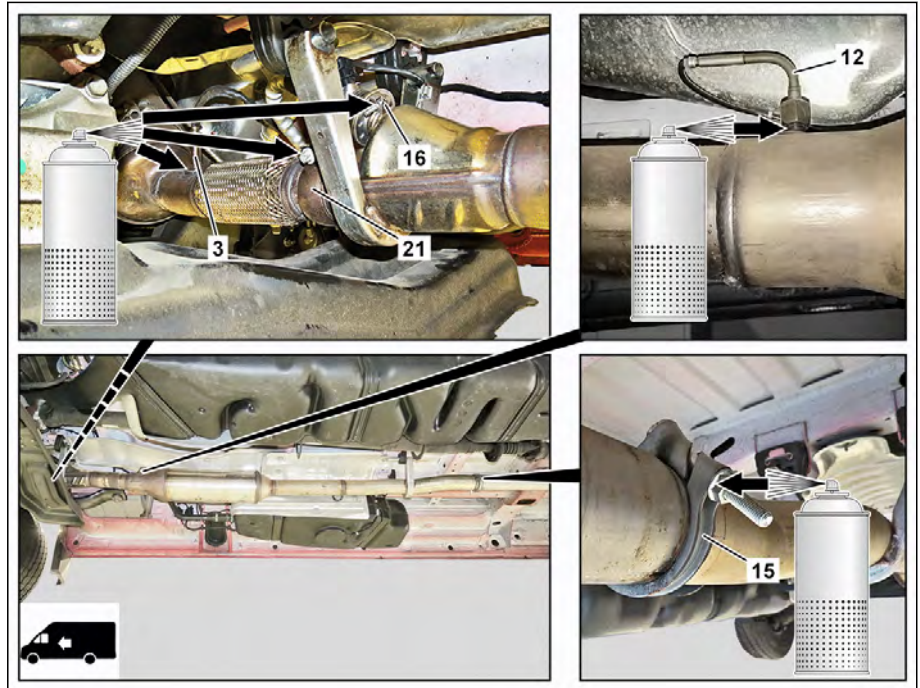

Removal of SCR Catalytic Converter

- 16 The NO_x sensor harness downstream of the SCR catalytic converter (5) should be cut for ease of removal.



The NO_x sensor downstream of the SCR catalytic converter (5) is to remain in the SCR catalytic converter and to be **returned** together.

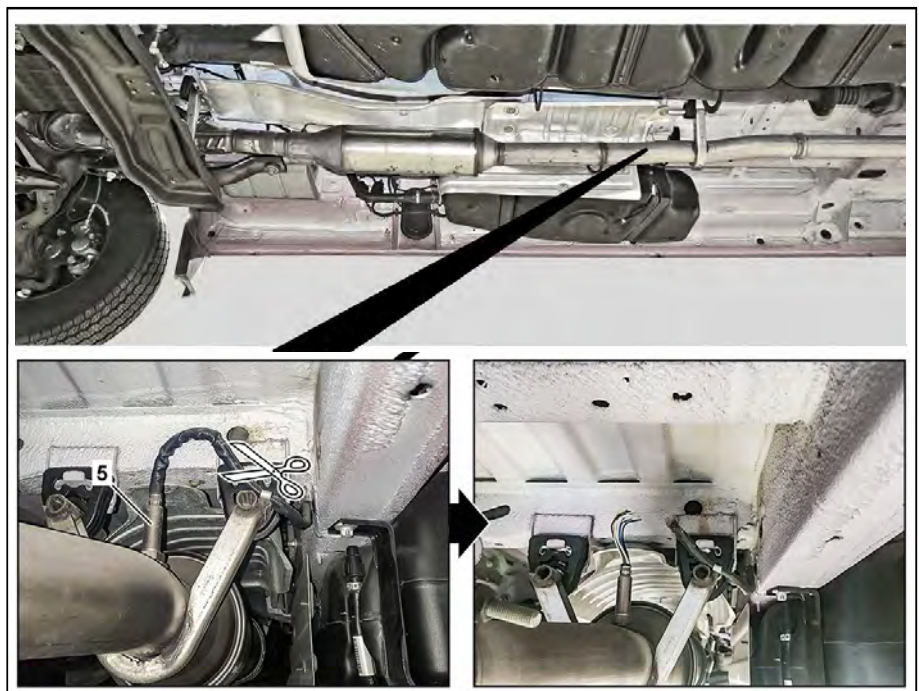

- 17 Loosen the clamp (15) at tailpipe (13) connection.

- 18 **Lift:** Remove tailpipe (13) from decoupling element (arrow). Remove tailpipe (13) from vehicle.

Ramps: place a rag (arrow B) between the tailpipe (13) and the rear axle. Also Place a rag (arrow A) between the tailpipe (13) and the floor. Lay tailpipe on the floor.

- 19 Remove and dispose the clamp (15).



Observe state-specific regulations for disposal.

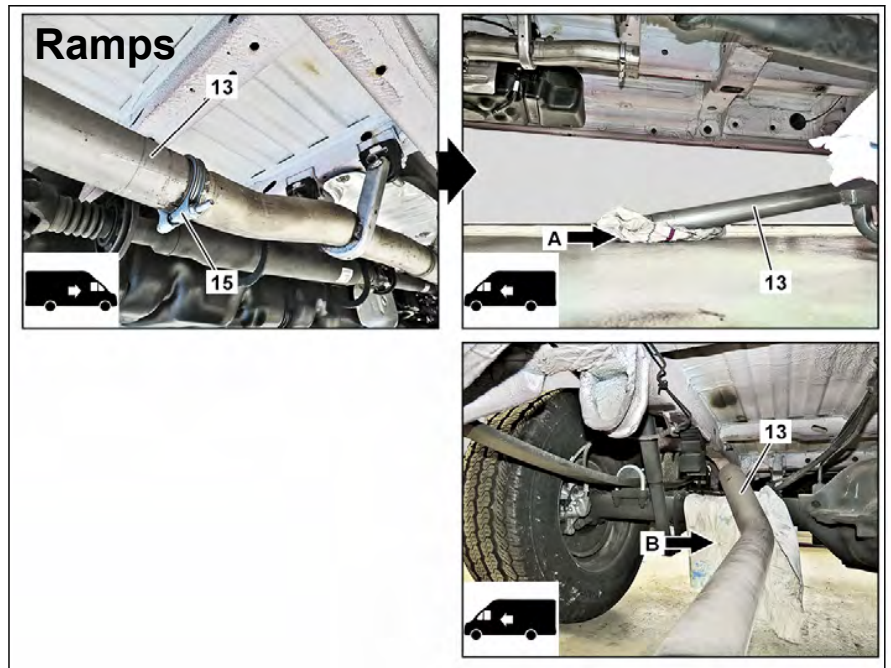
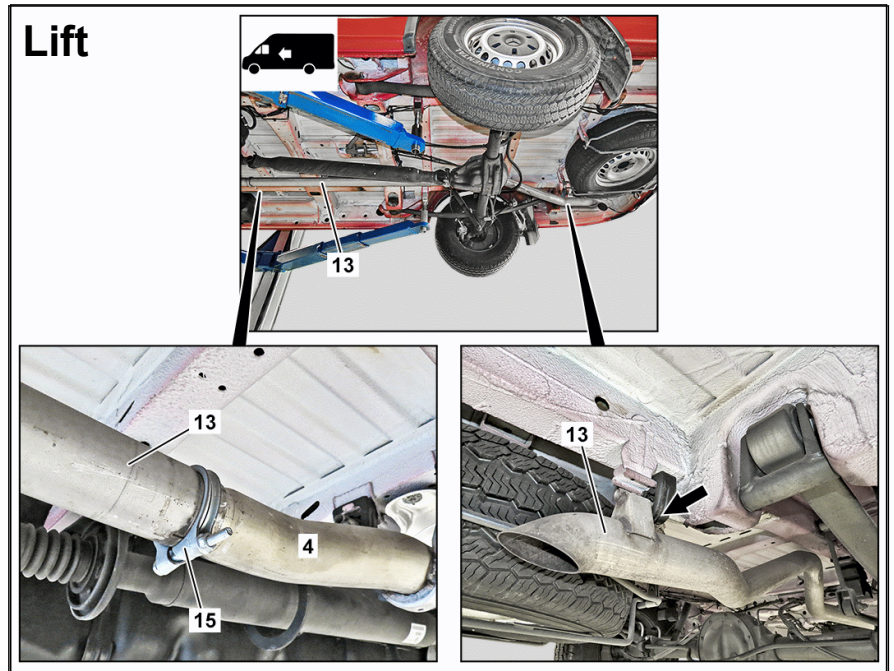

- 20 Remove exhaust gas temperature sensor (12) upstream of the SCR catalytic converter.



This is done by unscrewing the union nut on the exhaust gas temperature sensor (12) in a counter-clockwise direction. Position the exhaust gas temperature sensor (12) outside the working area.

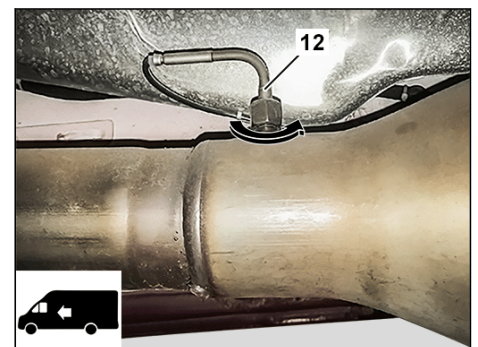

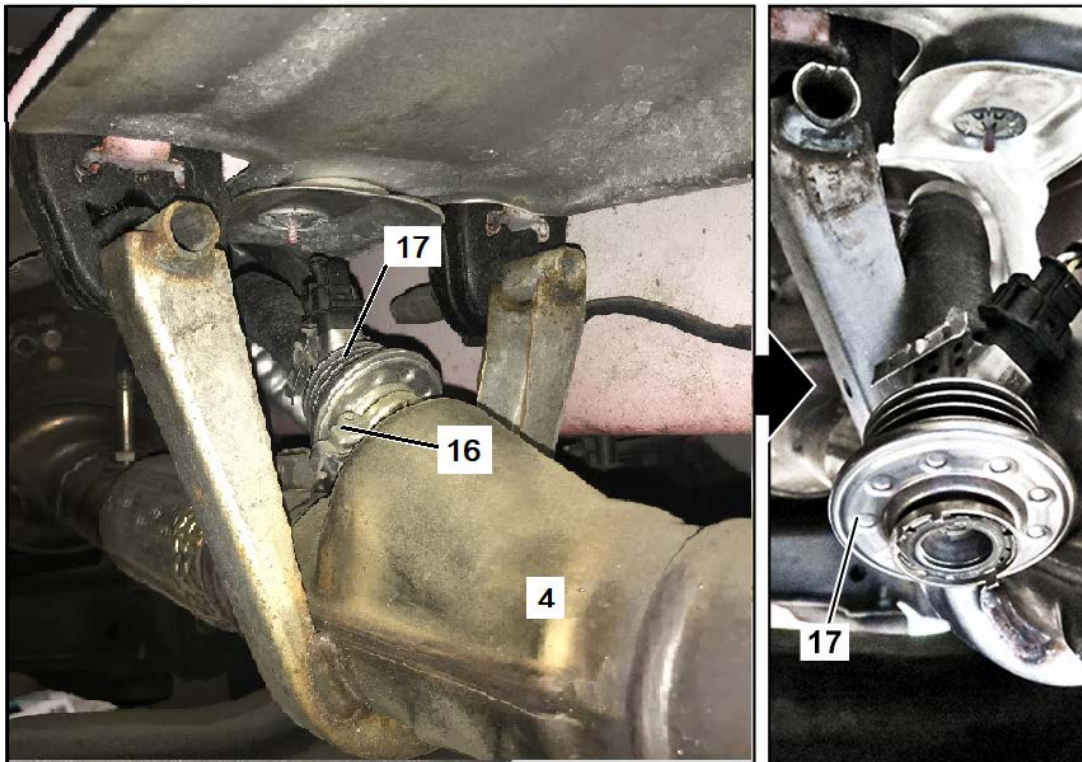

21 Remove the screw on the clamp (16) of the AdBlue® injection nozzle (17).

22 Remove and dispose clamp (16) at injection nozzle with a suitable tool and position the AdBlue® injection nozzle (17) outside the working area.



Observe state-specific regulations for disposal.

23 Remove and dispose the profile seal (18) on the AdBlue® injection nozzle (17).



Observe state-specific regulations for disposal.

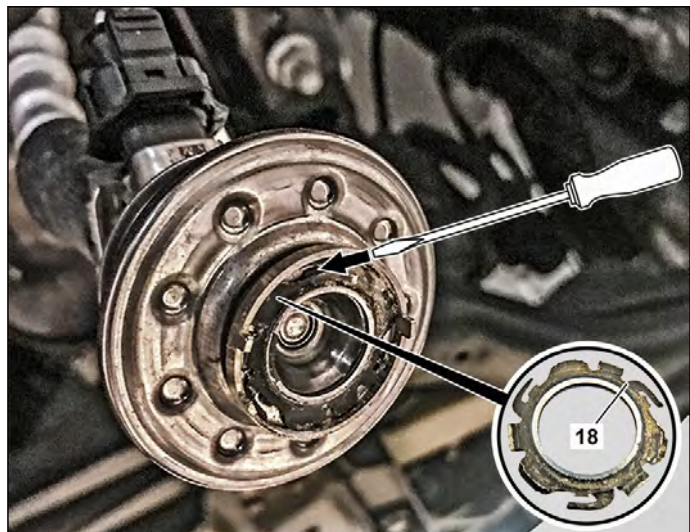

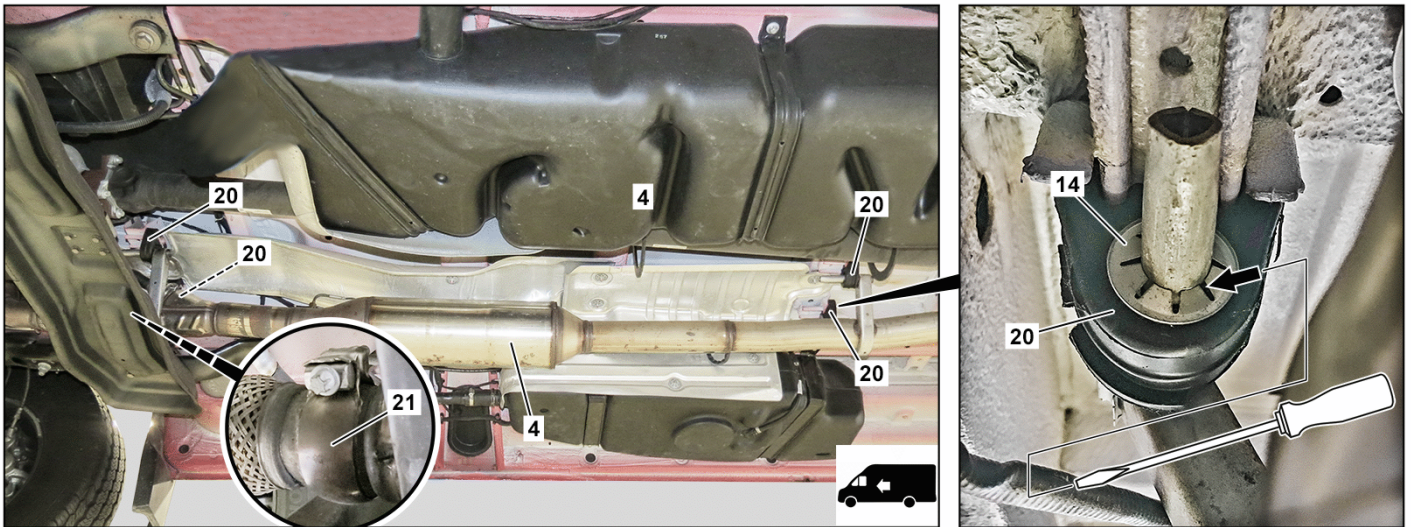

- 24 Remove and dispose the spring washer (14) on the holding bracket of the SCR catalytic converter (4).



This is done by bending up the individual locking fins with a screwdriver.



Observe state-specific regulations for disposal.

- 25 Loosen the clamp (21) between the flex pipe and the SCR catalytic converter (4).

- 26 Remove the SCR catalytic converter (4).



To do this, remove the SCR catalytic converter (4) from the decoupling elements (20).



Return the SCR catalytic converter (4) to the originating parts department.

- 27 Remove and dispose the clamp (21).



Observe state-specific regulations for disposal.



Removal of Upstream NO_x Sensor

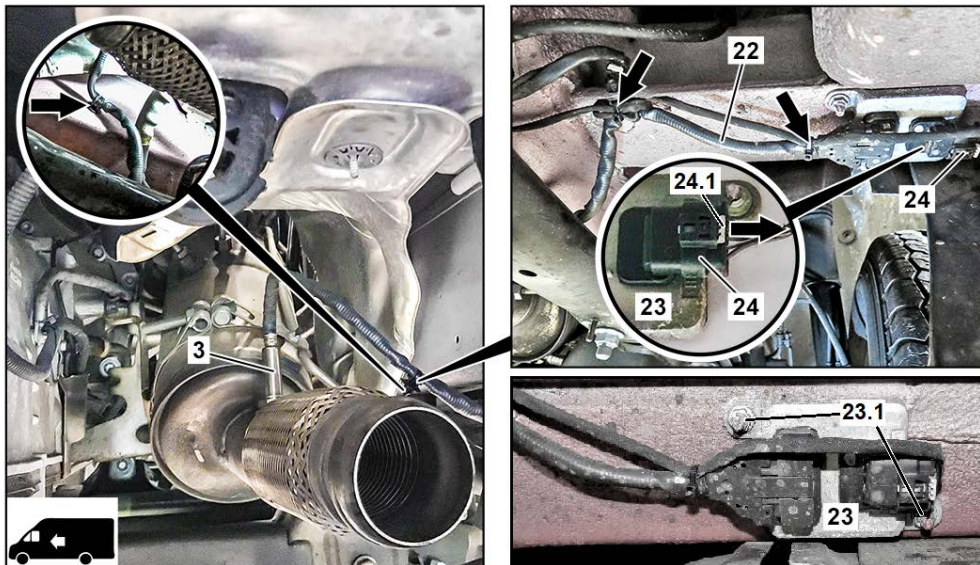

- 28 Disconnect the electrical plug connection (24) NO_x sensor control unit upstream of the SCR catalytic converter (23).



To do this, unlock the gray retaining tab (24.1) by moving towards the cable harness.

- 29 Remove the NO_x sensor control unit upstream of the SCR catalytic converter (23) from the frame.



To do this, remove and dispose nuts (23.1).

- 30 Remove and dispose the remaining cable ties and retaining clips (arrows) from harness (22) of the NO_x sensor control unit upstream of the SCR catalytic converter (23).



Observe state-specific regulations for disposal.

- 31 Remove NO_x sensor upstream of SCR catalytic converter (3).



The control unit for the NO_x sensor and the NO_x sensor upstream of the SCR catalytic converter (3) are a single unit.



Return the NO_x sensor upstream of SCR catalytic converter (3) to the originating parts department.



- 32 Clean the threads and the contact surfaces on the exhaust pipe.

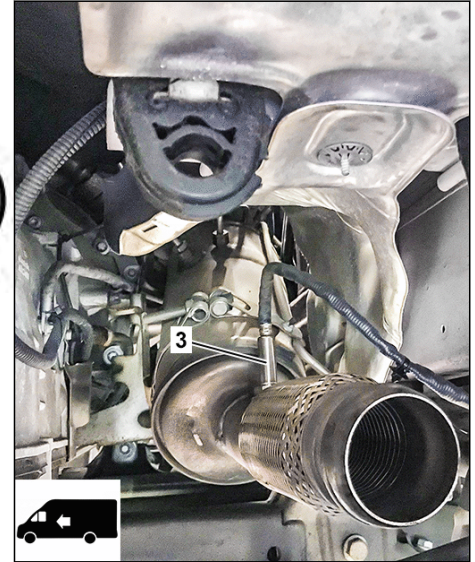

Removal of Downstream NO_x Sensor

- 33 Remove the heat shield (25).



This is done by bending up the individual locking fins with a screwdriver and unscrew the clamping nuts (26) in a counter-clockwise direction with a screwdriver.

- 34 Dispose the clamping nuts (26).



Observe state-specific regulations for disposal.



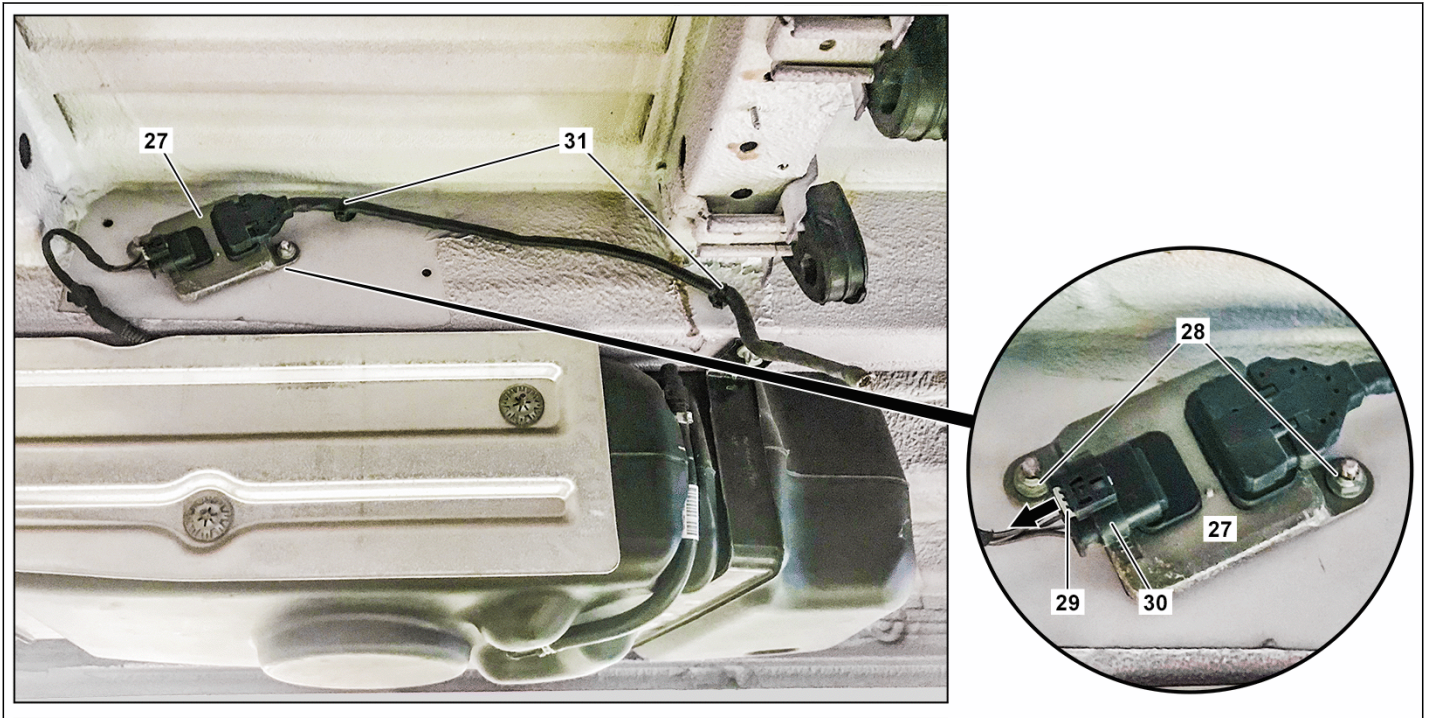

- 35 Disconnect the electrical plug connection (30) at the downstream NO_x sensor control unit (27).



To do this unlock the gray retaining tab (29) by moving in the direction of the arrow.

- 36 Remove the downstream NO_x sensor control unit (27).



To do this, remove and dispose the nut fasteners (28) and cable ties (31).



Return the downstream NO_x sensor control unit (27) to the originating parts department.



Installation of Upstream NO_x Sensor



Completely remove the adhesive labels that are on the new exhaust system and its components and leave no residue.

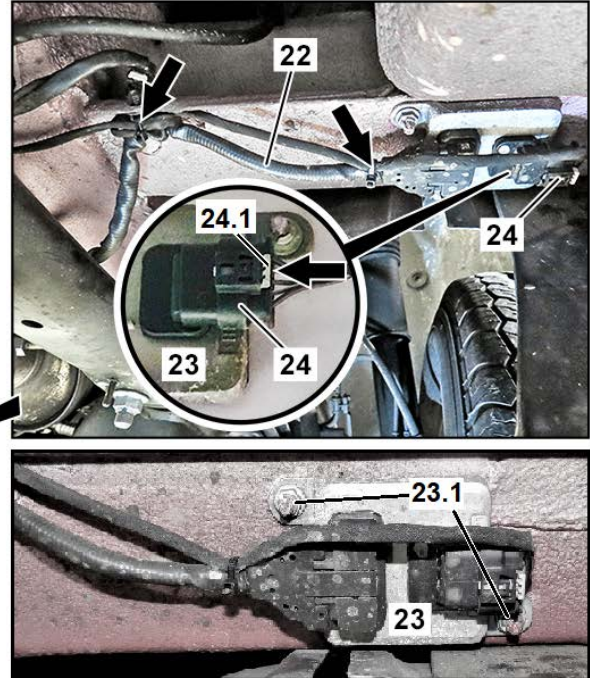

- 37 Install new NO_x sensor upstream of SCR catalytic converter (3).



A 000 905 85 11 80 (included in package A 642 905 20 00 85)

NO_x sensor upstream of SCR catalytic converter. Torque to: **60 Nm / 44.3 ft·lb**

- 38 Install the NO_x sensor control unit upstream of the SCR catalytic converter (23) on the frame.



Use new fasteners (23.1)
N 000000 003477

NO_x sensor control unit. Torque to: **9 Nm / 6.6 ft·lb**

- 39 Connect the electrical plug connection (24) and lock the retaining tab (24.1).



Push the gray retaining tab (24.1) in the direction of the arrow to lock.

- 40 Secure the harness (22) with cable ties (arrows), as shown.



A 000 995 90 06 (1x)
A 007 997 56 90 (2x)

Installation of SCR Catalytic Converter

- 41 Install a new profile seal (18) on the AdBlue® injection nozzle (17).



Clean the sealing surface of the AdBlue® injection nozzle (17) before installation. If excess crystallization of AdBlue® is present, use water and a non-abrasive cloth to clean the AdBlue® injection nozzle (17).



A 207 492 00 00

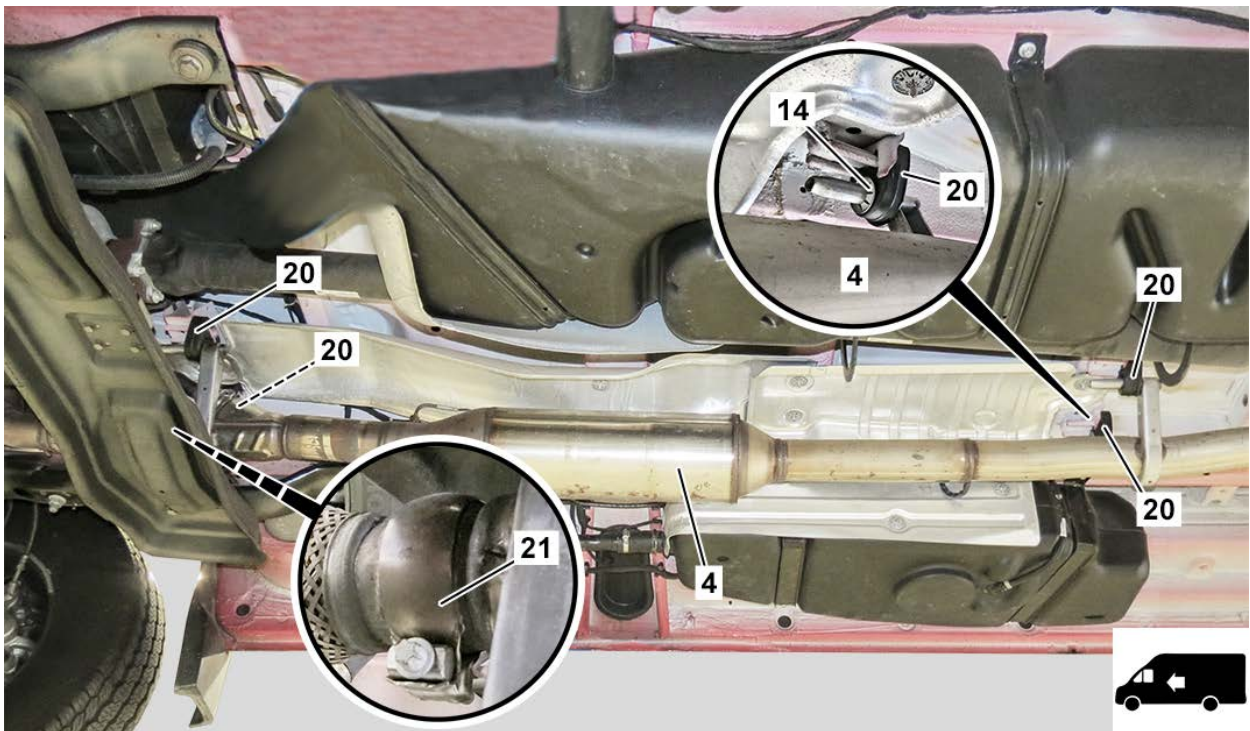
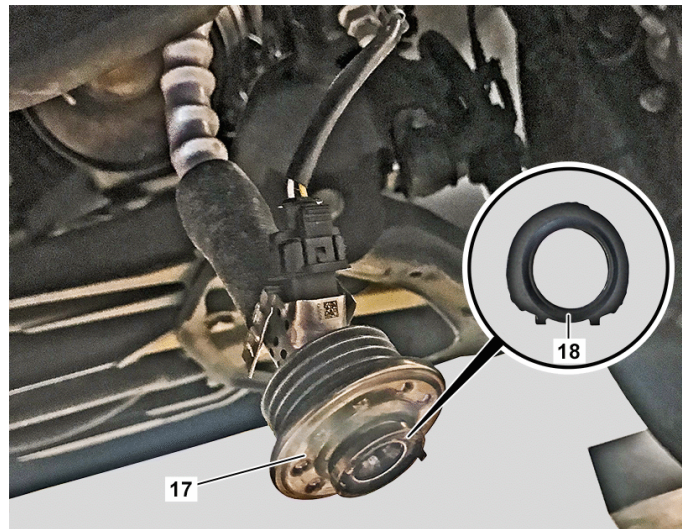

- 42 Position the new clamp (21) on the exhaust pipe.



A 000 490 13 41

- 43 Install new SCR catalytic converter (4).



Make sure that the SCR catalytic converter is correctly seated in the decoupling elements (20).



A 906 490 36 00 80

- 44 Tighten the new clamp (21).



Screw connection point needs to be pointed downward.

Clamp diesel particle filter on SCR catalytic converter. Torque to:
35 Nm / 25.8 ft·lb

- 45 Install new spring nut (14) on the holding bracket of SCR catalytic converter (4).



A 123 994 13 45

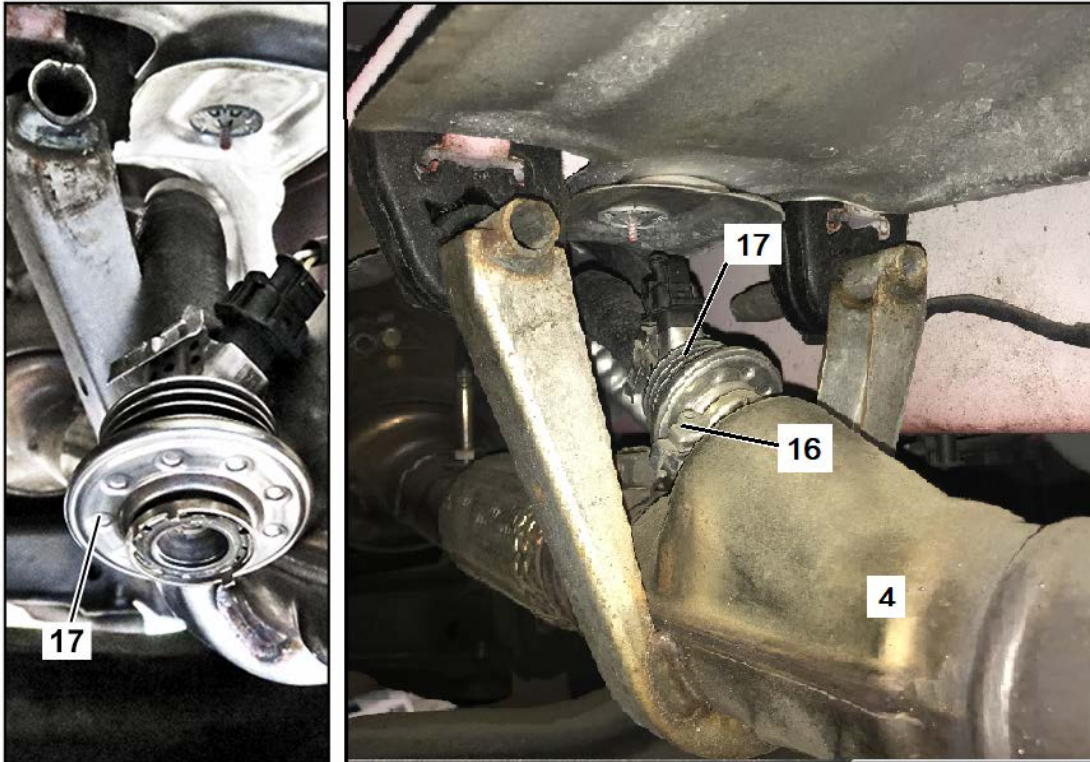

- 46 Install the AdBlue® injection nozzle (17).



Position the new profile clamp (16) on the SCR catalytic converter (4) first.



A 000 995 11 33



Ensure correct positioning of the Adblue® injection valve (17). The catch (arrows) of the Adblue® injection valve must sit in the groove of the exhaust pipe (4).

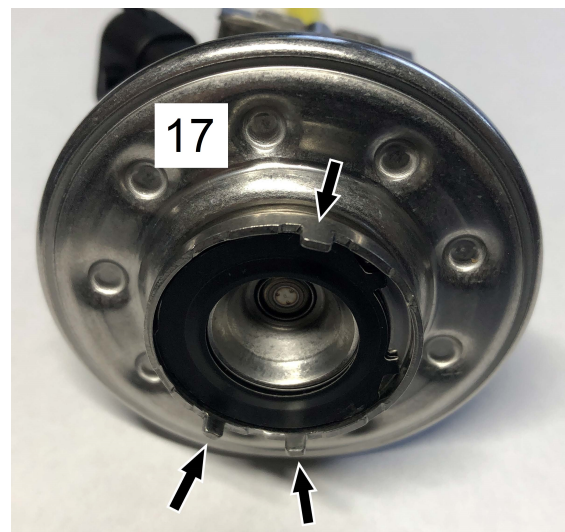

- 47 Install the screw on the new profile clamp (16) on the AdBlue® injection nozzle (17).



Screw: Torque to **5 Nm / 3.7 ft·lb**

- 48 Install the exhaust gas temperature sensor (12) upstream of the SCR catalytic converter.



Apply nickel anti-seize paste to threads only. Avoid contact to the sensor.

A 000 989 76 51 (bulk paste; can be applied to multiple vans)



Temperature sensor: Torque to **45 Nm / 33.2 ft·lb**

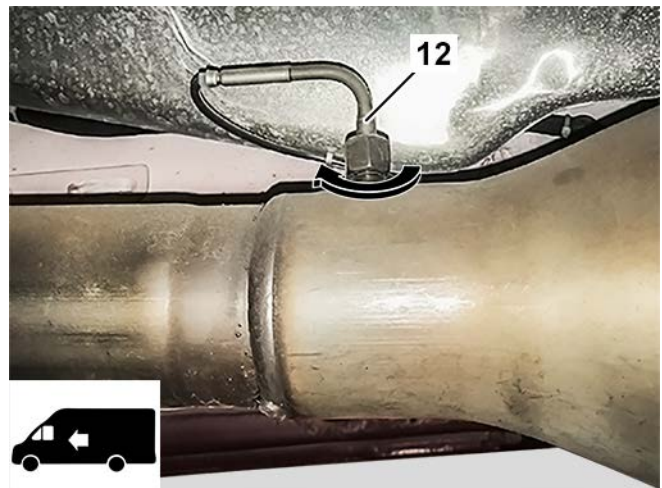

Installation of Downstream NOx Sensor

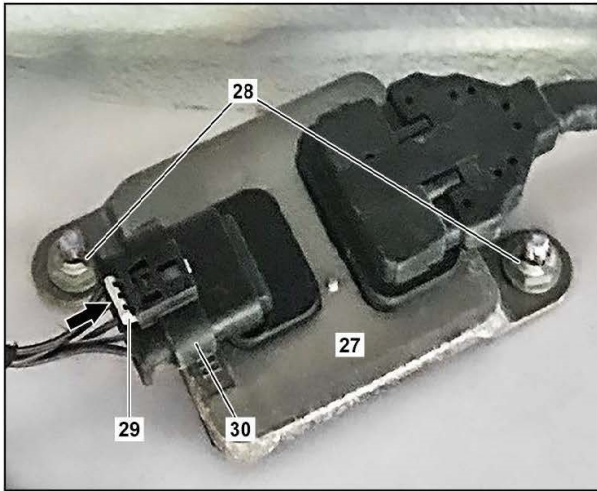

- 49 Install new NO_x sensor control unit downstream of the SCR catalytic converter (4).



A 000 905 85 11 80 (included in package A 642 905 20 00 85)

Use new nut fasteners (28):

N 000000 003477

NO_x sensor control unit. Torque to:
9 Nm / 6.6 ft·lb

- 50 Connect the electrical plug connection (30) and lock the retaining tab (29).



Push the gray retaining tab (29) in the direction of the arrow to lock.

- 51 Install the new NO_x sensor downstream of the SCR catalytic converter (5) on the new SCR catalytic converter.



NO_x sensor downstream of catalytic converter. Torque to: **60 Nm / 44.3 ft·lb**

- 52 Tie back excess length of the harness (32) in a loop. Secure harness (32) with cable tie (31).



A 007 997 56 90 (1x)



Do not route the harness (32) under tension. Otherwise damage could occur.

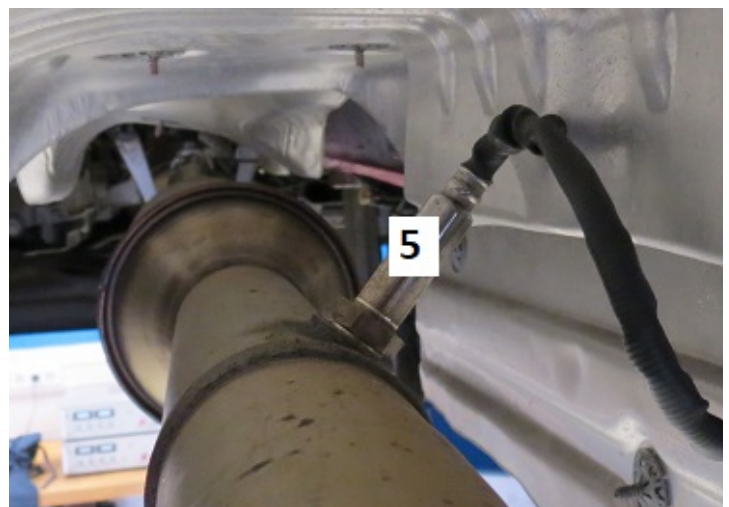

53 Install the heat shield (25).



To do this, place the new clamping nuts (26) centrally on the pin, as shown, and slide up to the stop using a socket wrench.



A 000 994 32 11

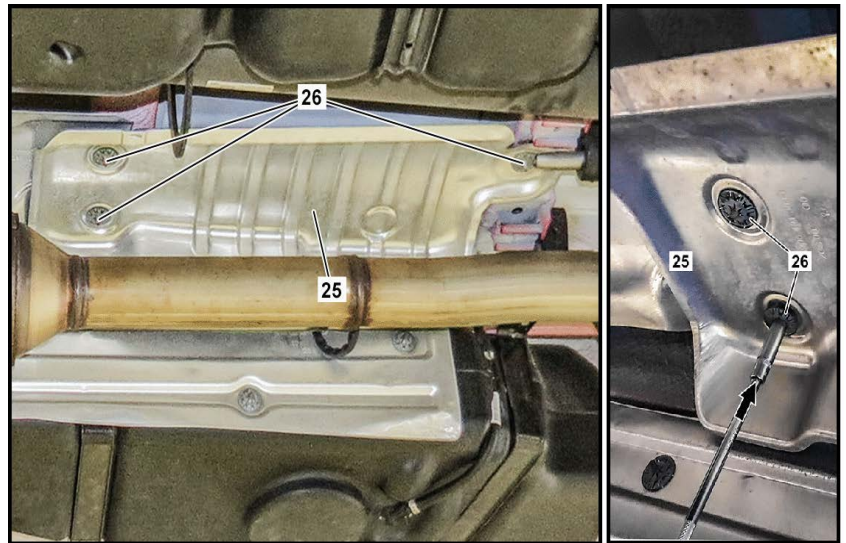

54 Install the new mounting tab (34) on the heat shield (25).



A 220 546 18 43

55 Clip the harness (32) into the mounting tab (34).



Do not kink the harness (32) and make sure it is not routed so as to be abraded. This prevents damage.



The harness (32) must not touch heat shield (25). This prevents damage.



The layout schematic of the harness (32) has changed on account of the changed position of the NO_x sensor downstream of the SCR catalytic converter (4).

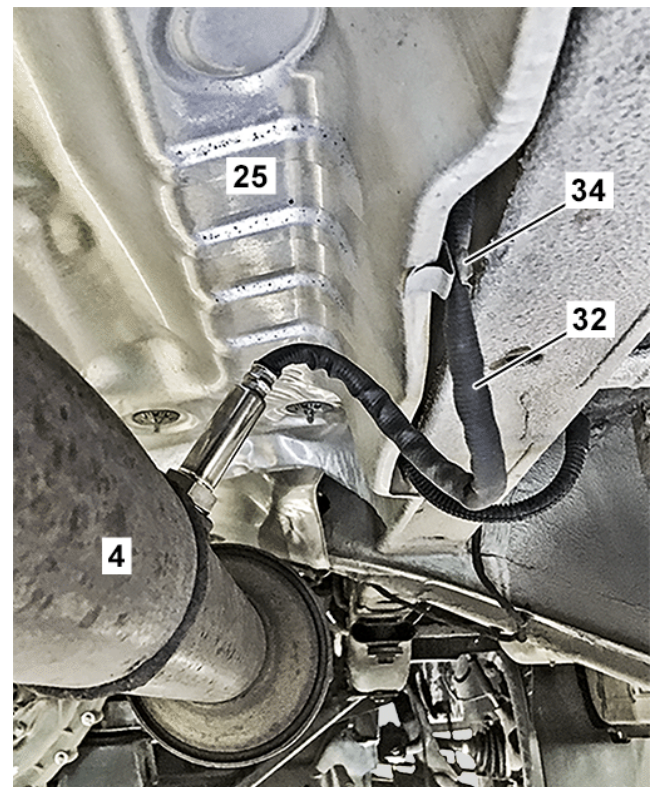

- 56 Position new clamp (15) on the SCR catalytic converter (4).



A 906 995 02 02

- 57 Install the tailpipe (13) of the exhaust system.

- 58 Align tailpipe (13) and tighten the new clamp (15).



Ensure adequate clearance of the tailpipe to the frame in the area of the rear decoupling element.



Clamp main muffler on endpipe:
Torque to **23 Nm / 17 ft·lb**

- 59 **Lift:**
Lower the vehicle.

Ramps:
Remove wheel chocks, release parking brake, and drive the vehicle off the ramps.

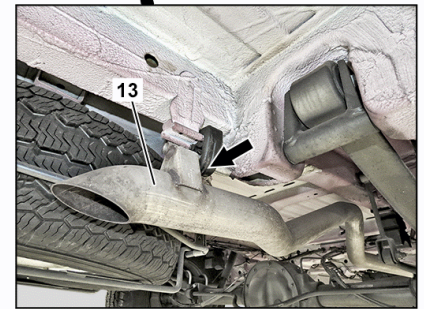
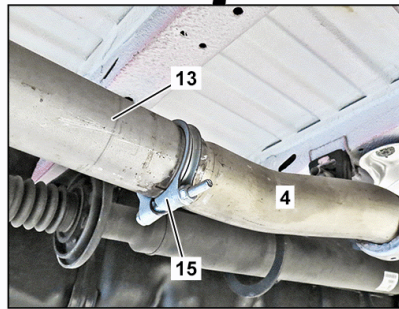
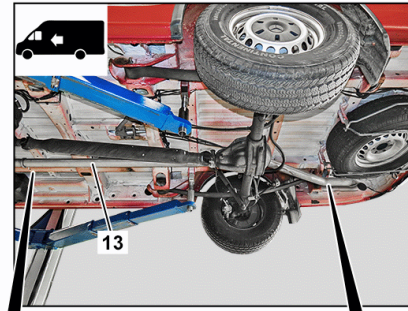

Drive the vehicle slowly and at a constant speed off the ramps.

Otherwise the vehicle may be damaged.

Removal of auxiliary battery



The work steps 60 to 68 must only be carried out if an auxiliary battery is installed in the engine compartment.

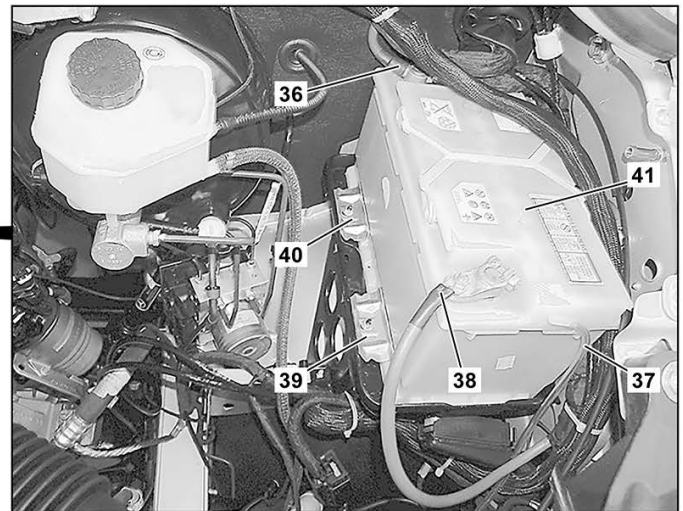

- 60 Remove the ground line (38) on the auxiliary battery (41).
- 61 Remove the positive line (36) on the auxiliary battery (41).
- 62 Disconnect the venting line (37) on the auxiliary battery (41).

- 63 Remove the battery tie down brackets (39, 40).
- 64 Remove the auxiliary battery (41).

- 65 Remove the bolts (45).
- 66 Remove the wash water reservoir (44) upwards out of the guides and set aside with the lines and hoses connected.

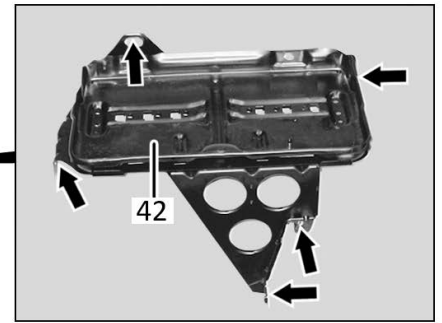

- 67 Remove the threaded bushing (43).
- 68 Remove battery tray (42).



To do this, remove the bolts and remove the nuts. The battery tray (42) is fixed to the chassis with four bolts and a nut (arrows).

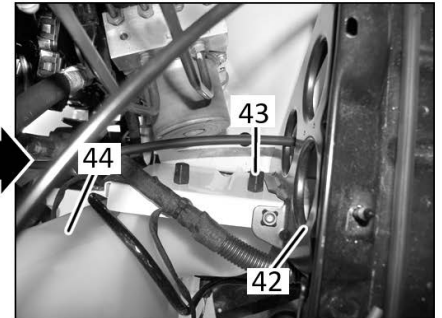
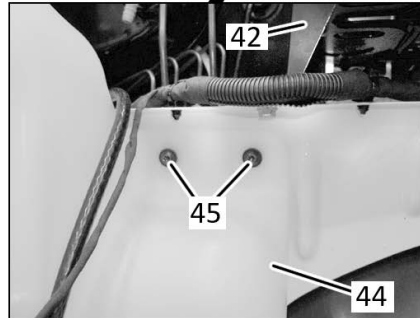

Execution of the AEM Special Procedure

- 69 Connect the battery charger to the vehicle's jump posts as indicated. (arrows)



A sufficient power supply to the vehicle on-board system must be ensured throughout the entire work procedure.

Otherwise any undervoltage that occurs may damage the control units.



Do not connect the battery charger to the auxiliary battery in the engine compartment.



Follow the operating instructions for the battery charger.



Use a Mercedes-Benz recommended battery charger to ensure an adequate voltage supply (min. 12.5 V) is provided for the on-board electrical system battery.

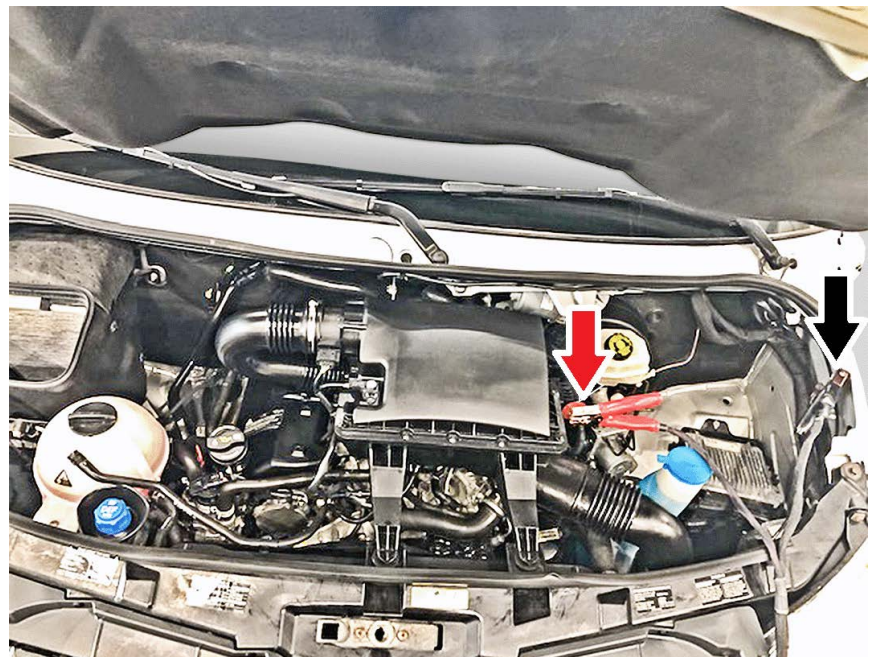

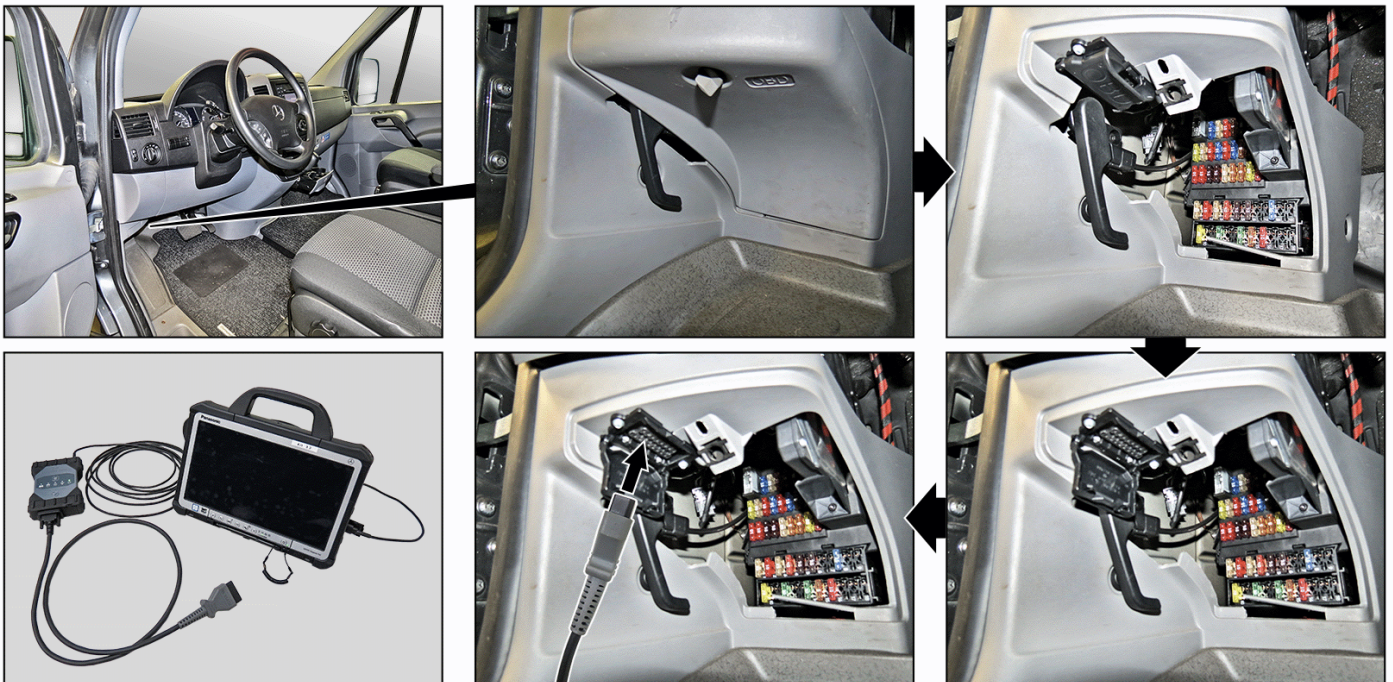

70 Connect the diagnostic system.



The diagnostic system remains connected to the vehicle throughout the work procedure!
Do not disconnect the diagnostic system's online connection.

71 Switch on the ignition.

72 Start the diagnostic system.

73 Run XENTRY and start special procedure of customer service measure.



To do this, select the following menu items:
Control units → Drive → CDI6 → Special procedure → Service measure "Exhaust gas after-treatment"



The process starts automatically after starting the special procedure. The operation steps must be performed exactly as per the diagnostic system.

If a fault arises during the special procedure, repeat the procedure. If the fault persists, create a PTSS case or XSF-ticket including the following:

- Initial Quick test
- Current Quick test
- Control unit log
- AEM Result Report
- Support Package

A result report is displayed at the end of the special procedure. Upload this report to paperless pXD. The report must indicate "OK" for all items. Otherwise, the procedure must be repeated. The vehicle can only be returned to the customer after successfully completing the special procedure.



Parts of the procedure via the diagnostic system are shown on the following pages.

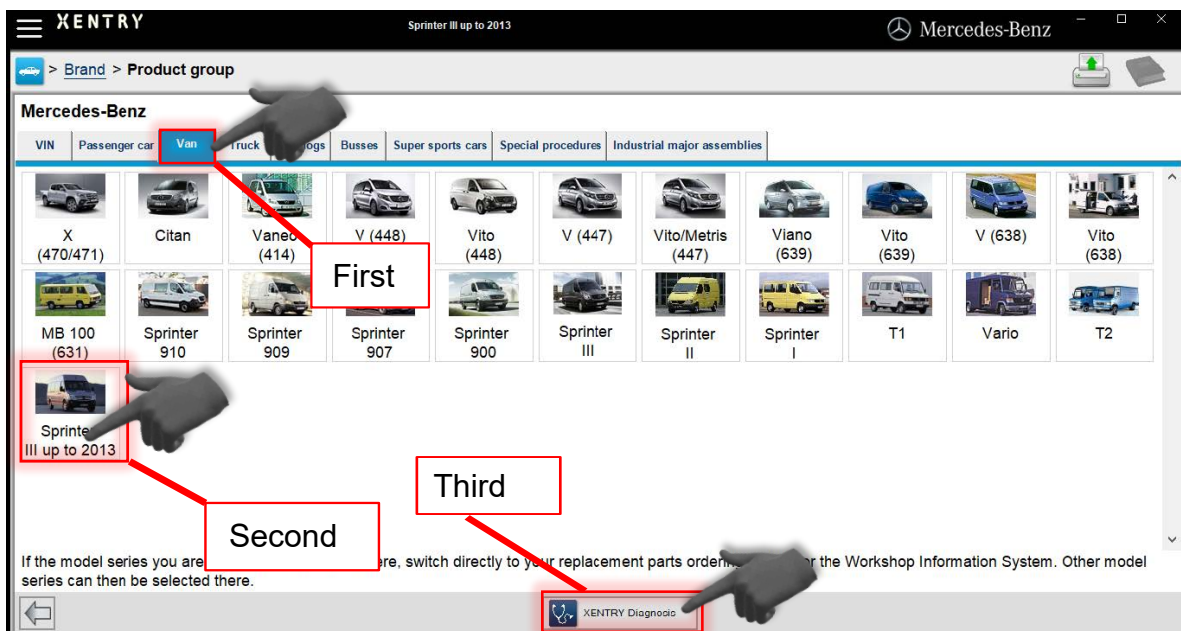



XENTRY Sprinter III up to 2013 Mercedes-Benz

> Brand > Product group > Vehicle

Model

Please select a vehicle model designation from product group 'Sprinter III up to 2013'.

You can now start XENTRY Diagnosis or select more vehicle data for other applications.

All

- 906.111 - 209/11/13/15 CDI FHS, 209/210/213/216 CDI FHS, 218 CDI FHS, 219 CDI FHS
- 906.113 - 209/11/13/15 CDI FHS, 209/210/213/216 CDI FHS, 216 FHS, 218 CDI FHS, 219 CDI FHS, 224 FHS
- 906.131 - 309/11/13/15/16 CDI FHS, 309/310/313/316 CDI FHS, 311/315 CDI FHS, 318 CDI FHS, 319 CDI FHS
- 906.132 - 309/11/13/15/16 CDI FHS, 309/310/313/316 CDI FHS, 318 CDI FHS, 319 CDI FHS
- 906.133 - 309/11/13/15/16 CDI FHS, 309/310/313/316 CDI FHS, 311/315 CDI FHS, 313/316 CDI FHS, 316 FHS, 318 CDI FHS, 319 CDI FHS, 324 FHS
- 906.134 - 309/11/13/15/16 CDI FHS, 309/310/313/316 CDI FHS, 318 CDI FHS, 319 CDI FHS
- 906.135 - 309/11/13/15/16 CDI FHS, 309/310/313/316 CDI FHS, 311/315 CDI FHS, 313/316 CDI FHS, 316 FHS, 318 CDI FHS, 319 CDI FHS, 324 FHS
- 906.136 - 309/11/13/15/16 CDI FHS, 309/310/313/316 CDI FHS, 318 CDI FHS, 319 CDI FHS
- 906.153 - 411/15, 509/11/15 CDI FHS, 413/16, 509/510/13/16 CDI FHS, 418/518 CDI FHS, 419/519 CDI FHS, 511/515 CDI FHS, 513/516 CDI FHS, 516 FHS, 518 CDI F
- 906.155 - 411/15, 509/11/15 CDI FHS, 413/16, 509/510/13/16 CDI FHS, 418/518 CDI FHS, 419/519 CDI FHS, 511/515 CDI FHS, 513/516 CDI FHS, 516 FHS, 518 CDI F
- 906.211 - 209/11/13/15 CDI FHL, 209/210/213/216 CDI FHL, 218 CDI FHL, 219 CDI FHL
- 906.213 - 209/11/13/15 CDI FHL, 209/210/213/216 CDI FHL, 216 FHL, 218 CDI FHL, 219 CDI FHL, 224 FHL
- 906.231 - 309/11/13/15/16 CDI FHL, 309/310/313/316 CDI FHL, 311/315 CDI FHL, 318 CDI FHL, 319 CDI, 319 CDI FHL
- 906.233 - 309/11/13/15/16 CDI FHL, 309/310/313/316 CDI FHL, 311/315 CDI FHL, 313/316 CDI FHL, 316 FHL, 318 CDI FHL, 319 CDI FHL, 324 FHL

XENTRY Diagnosis XENTRY Diagnosis Continue

DAS English

Vehicle 906 Control unit

NOTES

Information on preventing damage to electronic components due to electrostatic discharge :

- The safety information and descriptions listed in Help (F6) MUST be observed.

General test conditions :

- Use only cable with fuse for bridges.
- Each time after replacing a component, always carry out a component test.
- A component test should be carried out in order to ensure the correct connection of separated plug connections (electric or pneumatic).
- When processing a fault code, a fault code may be generated by a test step which is interrogated in a YES/NO cell.
- This step may temporarily result in other fault codes which should be ignored.
- Only generate counterfault by short circuit and open circuit if this is expressly requested in the decision tree.

Safety note :

- Pay attention to the safety notice 'AS 58.40-Z-0001-01A' on the use of the diagnostic units in mobile applications.

General information :

- The data read out of the control units refer to specific events or system statuses and serve as a basis for narrowing down the source of the defect. The data may include a tolerance and it may therefore not necessarily be possible to link them to a certain event, location or time.

ESC F1 F2 Forward F6 F11

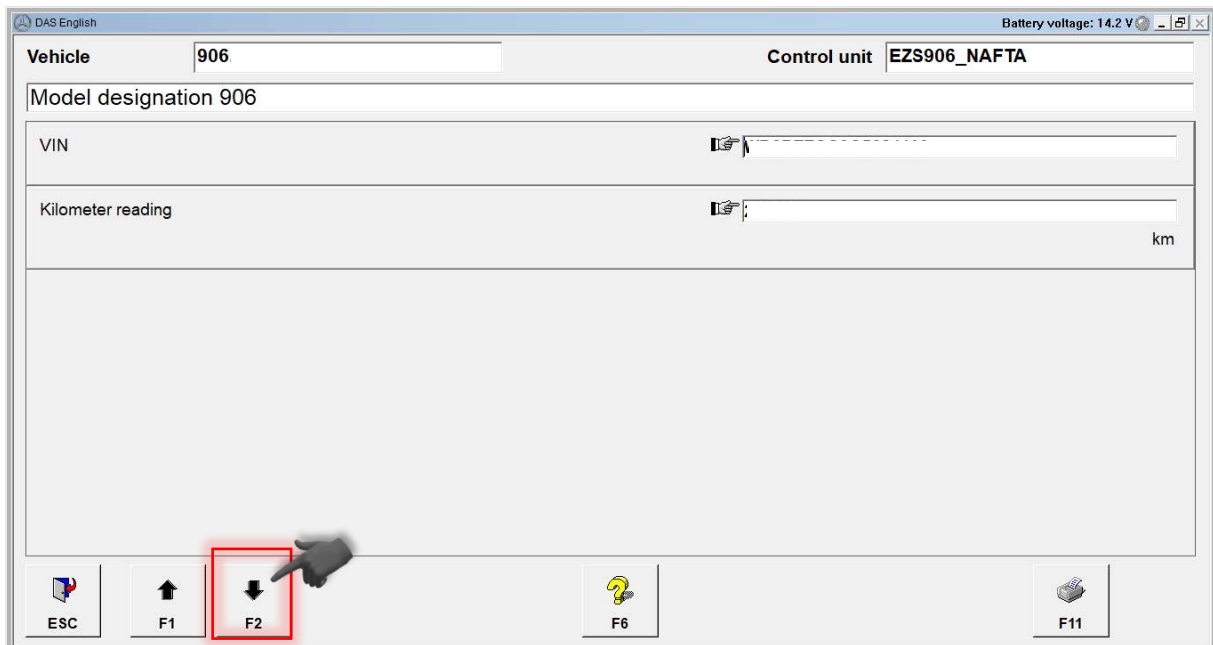
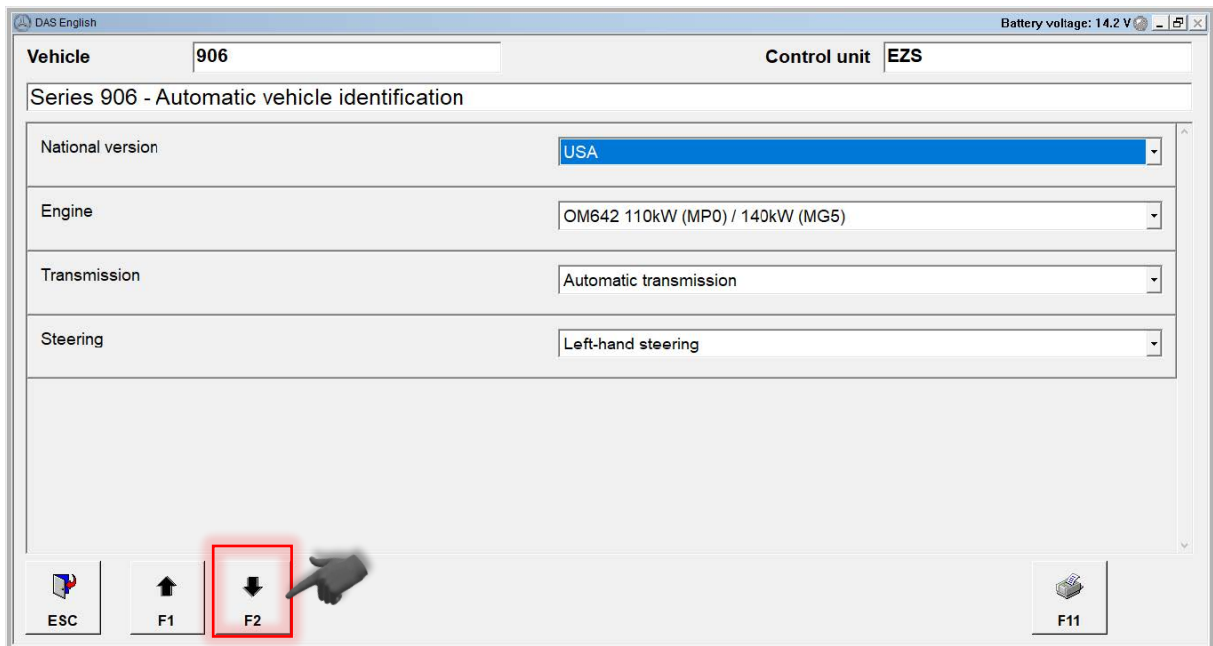

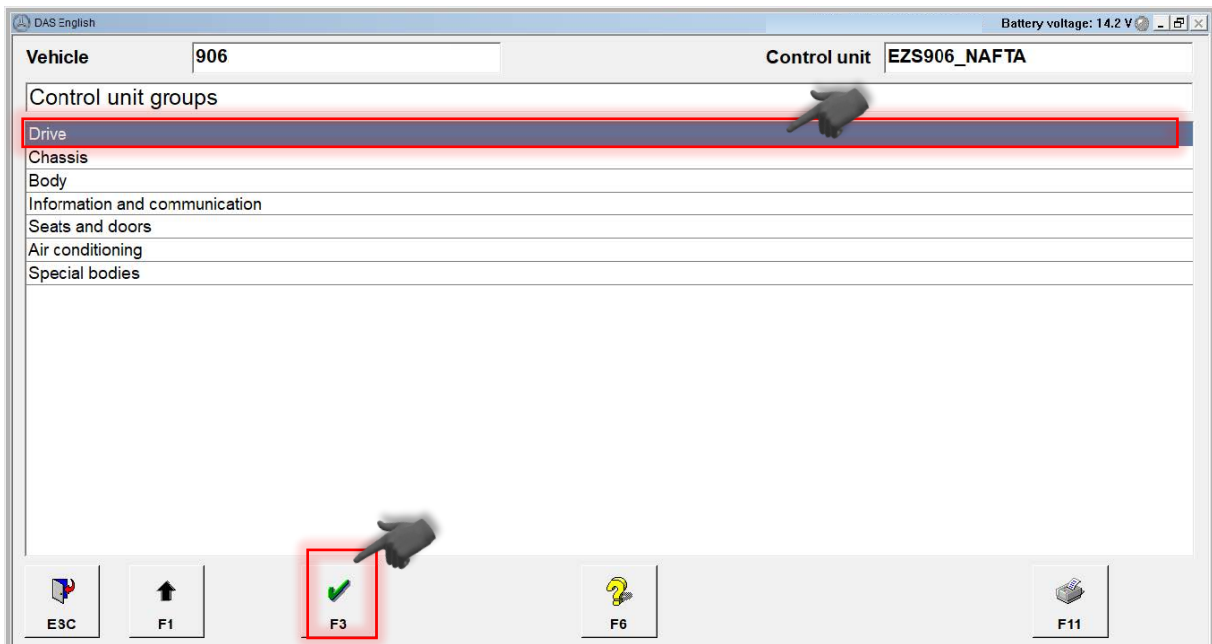
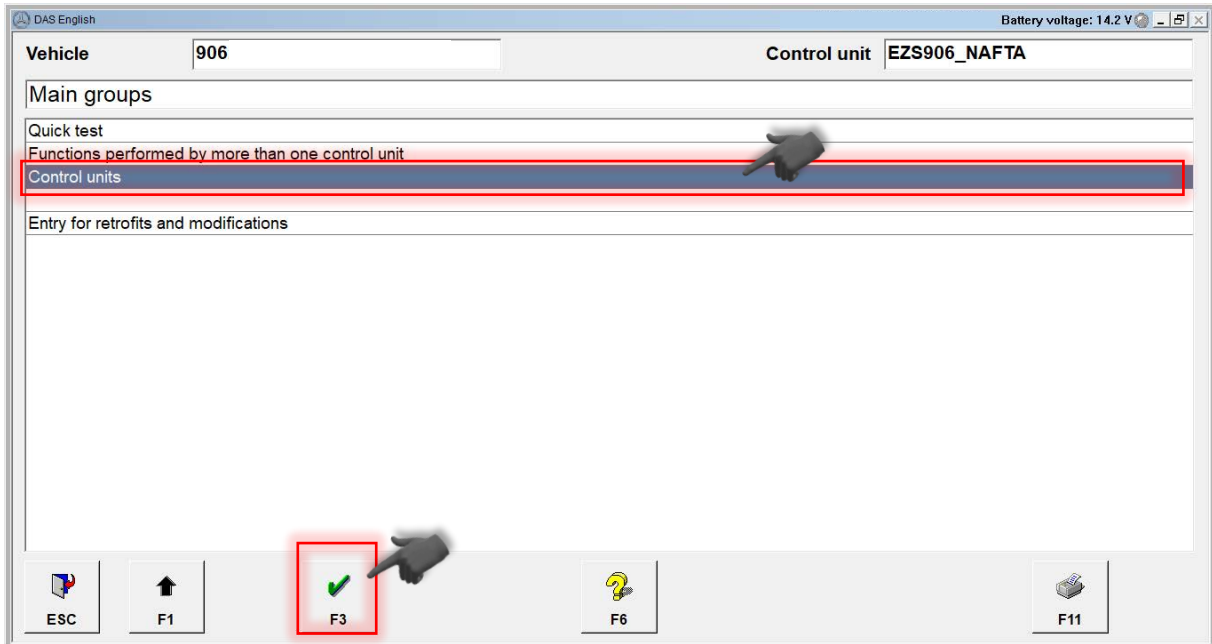

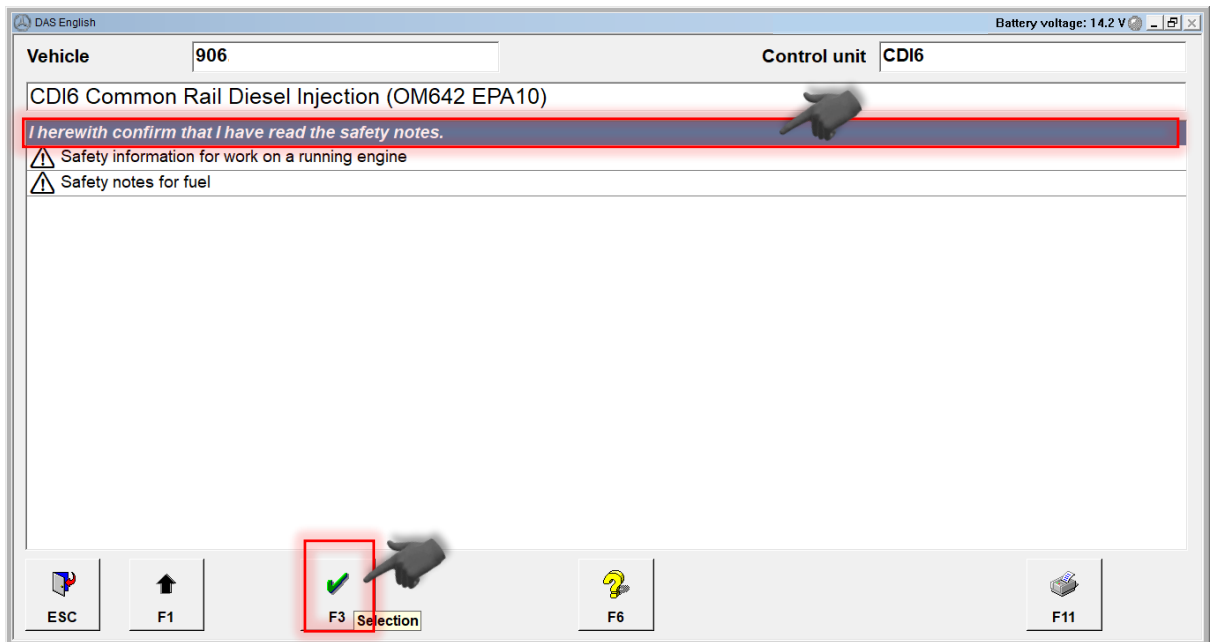
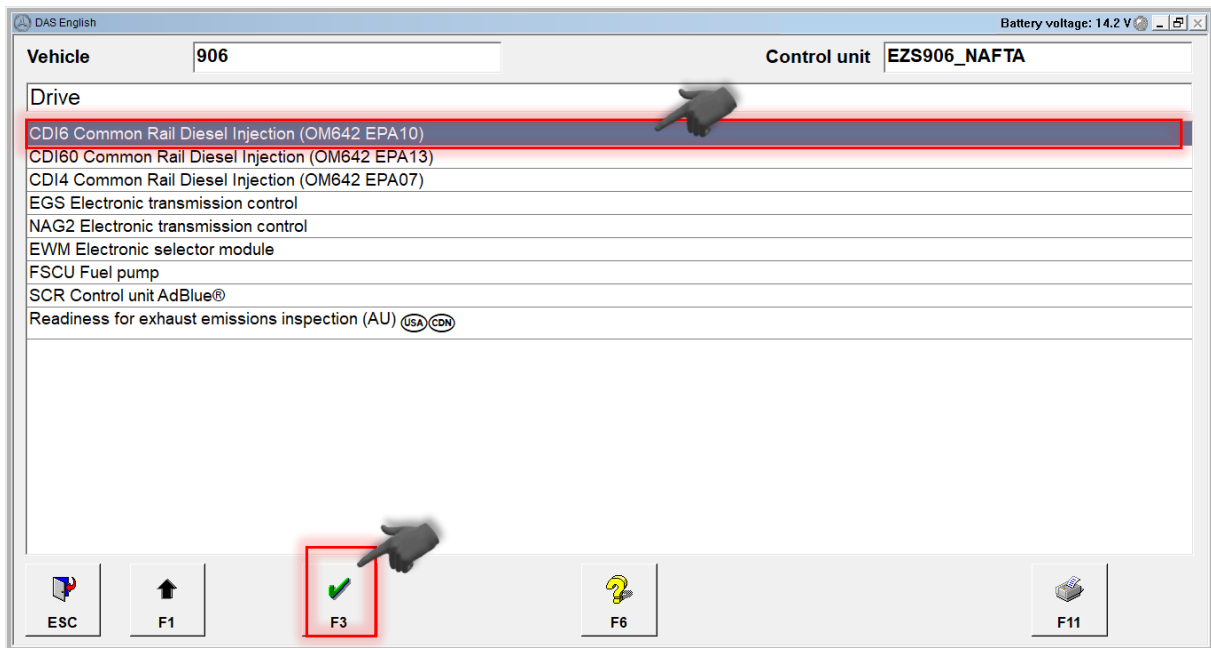

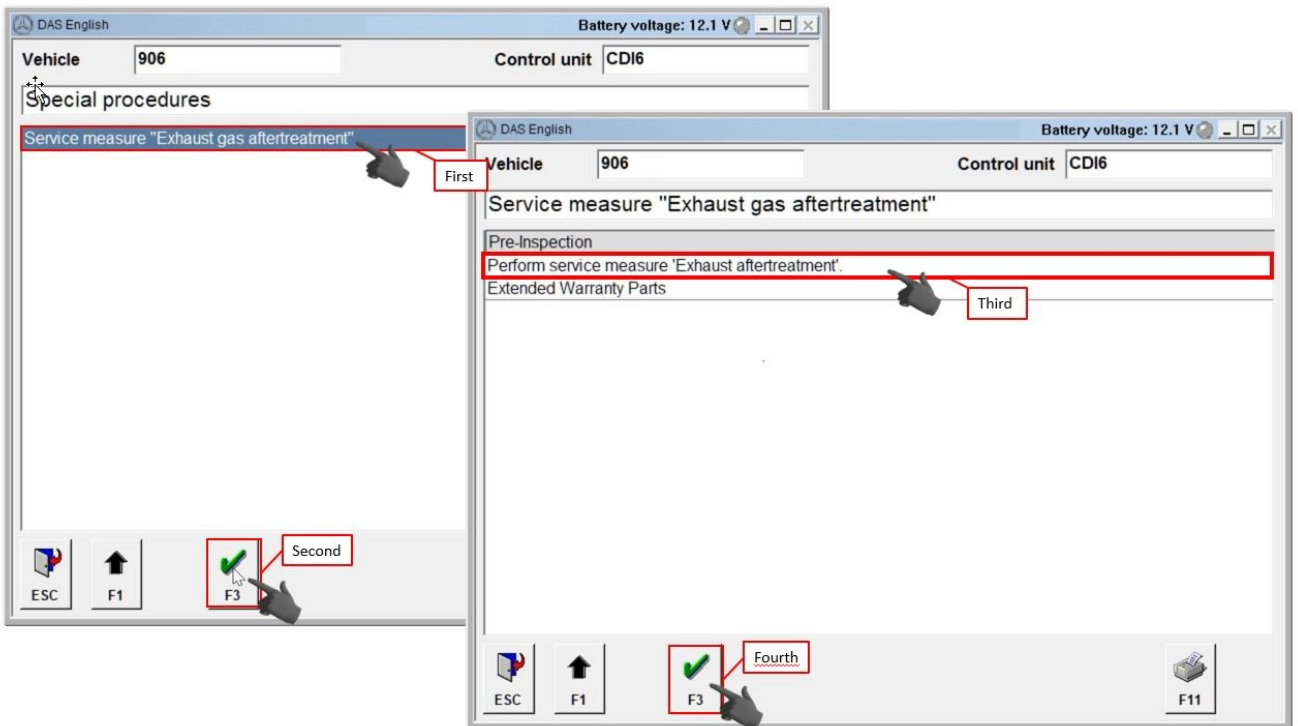
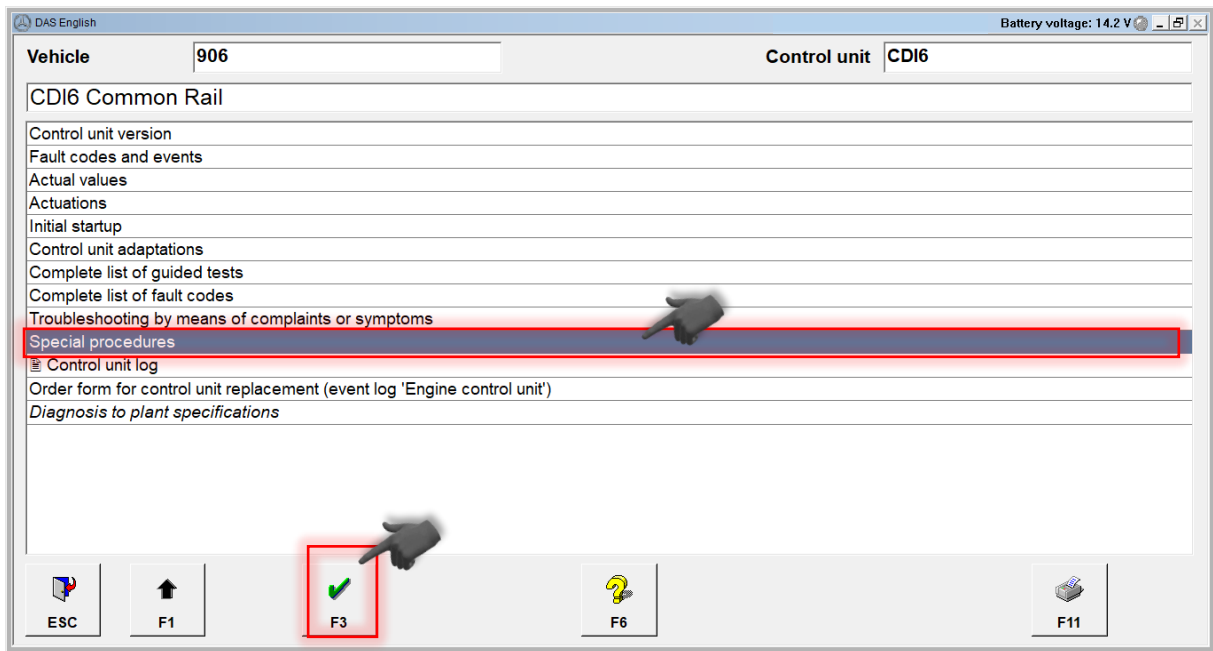



DAS English Battery voltage: 14.2 V

Vehicle Control unit

Service measure "Exhaust gas aftertreatment"

Step 1 Read out data from old control unit.

Step 2 Replace control module.

Step 3 Initial startup of new control unit CDI , Programming Control units ETC , IC

Step 4 Programming Control unit SCR , Check of software release

ESC F1 F11

DAS English Battery voltage: 14.2 V

Vehicle Control unit

Step 1 Read out data from old control unit.

Preconditions :

- Component Exhaust system was exchanged.
- Component NOx sensor upstream of SCR catalytic converter was exchanged.
- Component NOx sensor downstream of SCR catalytic converter was exchanged.
- Component The old control unit is still installed.

Question :

- Are all requirements met?

ESC F1 F3 F4

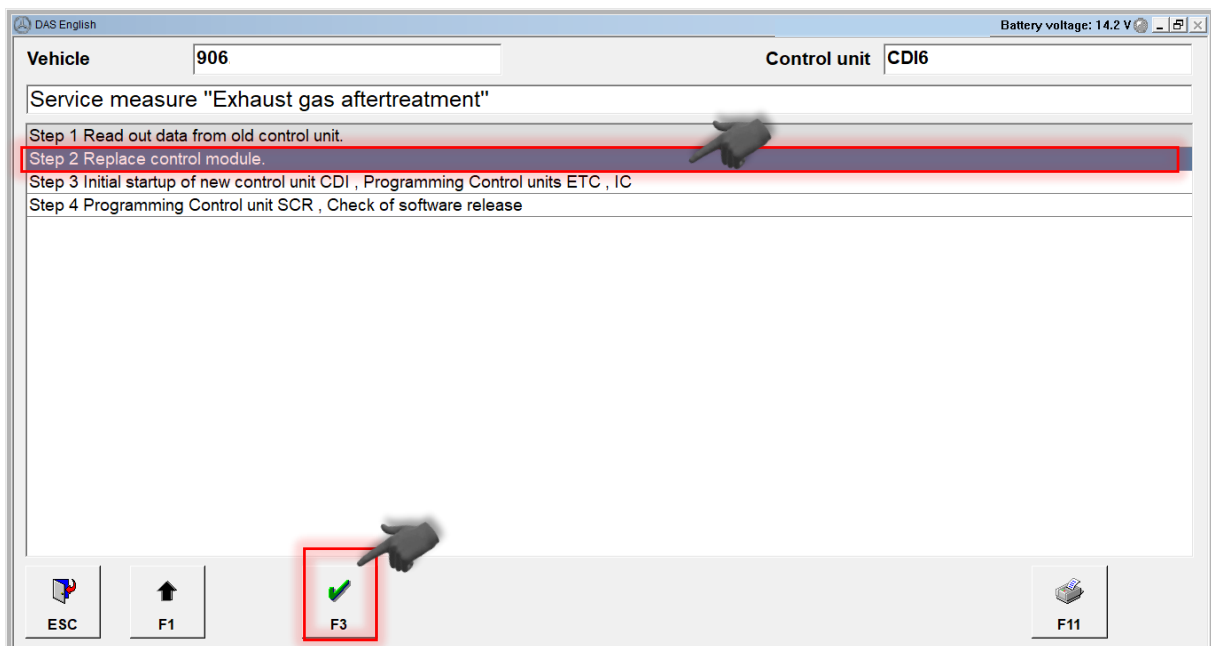



DAS English Battery voltage: 14.2 V

Vehicle Control unit

Step 2 Replace control module.

Preconditions :
- The data have been successfully read from the old control unit. (Step 1)

Question :
- Are all requirements met?

ESC ↑ F1 YES F3 NO F4 F11

DAS English Battery voltage: 14.2 V

Vehicle Control unit

Step 2 Replace control module.

Instruction :
- Switch off ignition.
- Remove control unit CDI6.
- Install control module CDI60 with replacement part number A 642 900 97 01 (A 642 901 35 00).
- Switch on ignition.

ESC ↑ F1 ↓ F2 F11

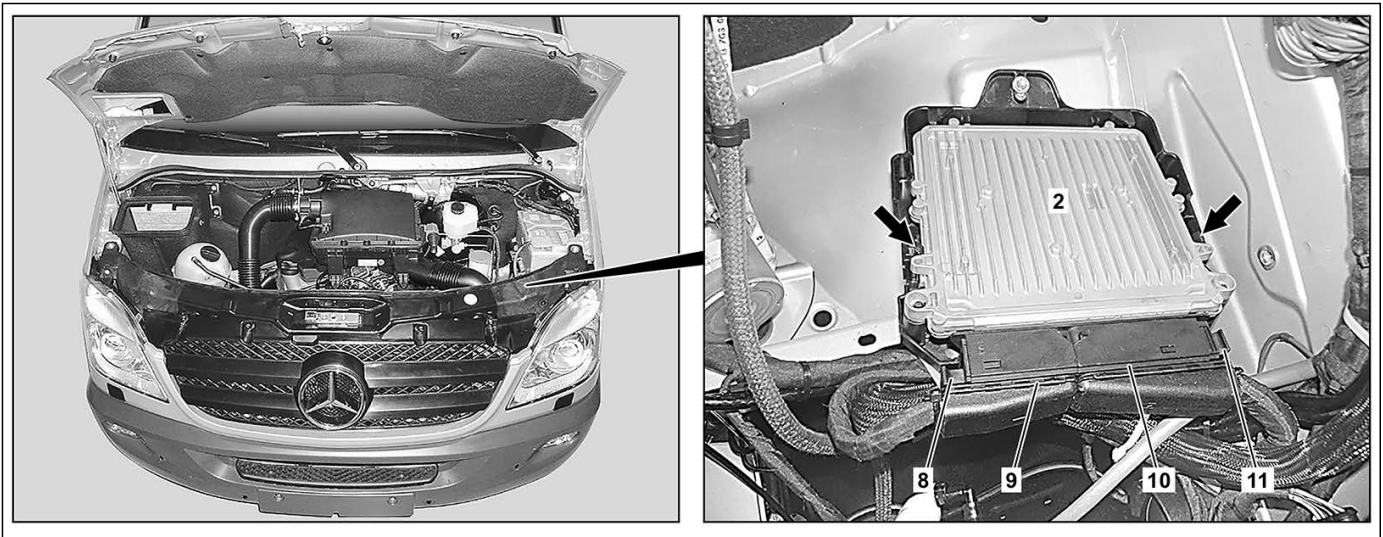

74 Follow the instructions of the diagnostic system to replace the control unit CDI (2).

75 Unlock the closing levers (8,11) by pulling and disconnect the electrical plug connections (9, 10) on the control unit CDI (2).

76 Unclip the control unit CDI (2) from the holder (arrows) and remove.



Return the control unit CDI (2) to the originating parts department.



77 Install the new control unit CDI (2).



A 642 900 97 01

78 Connect the electrical plug connections (9, 10) on the control unit CDI (2) and lock the closing levers (8, 11).

79 Continue with step 3: Initial startup of new control unit CDI, Programming Control units ETC, IC

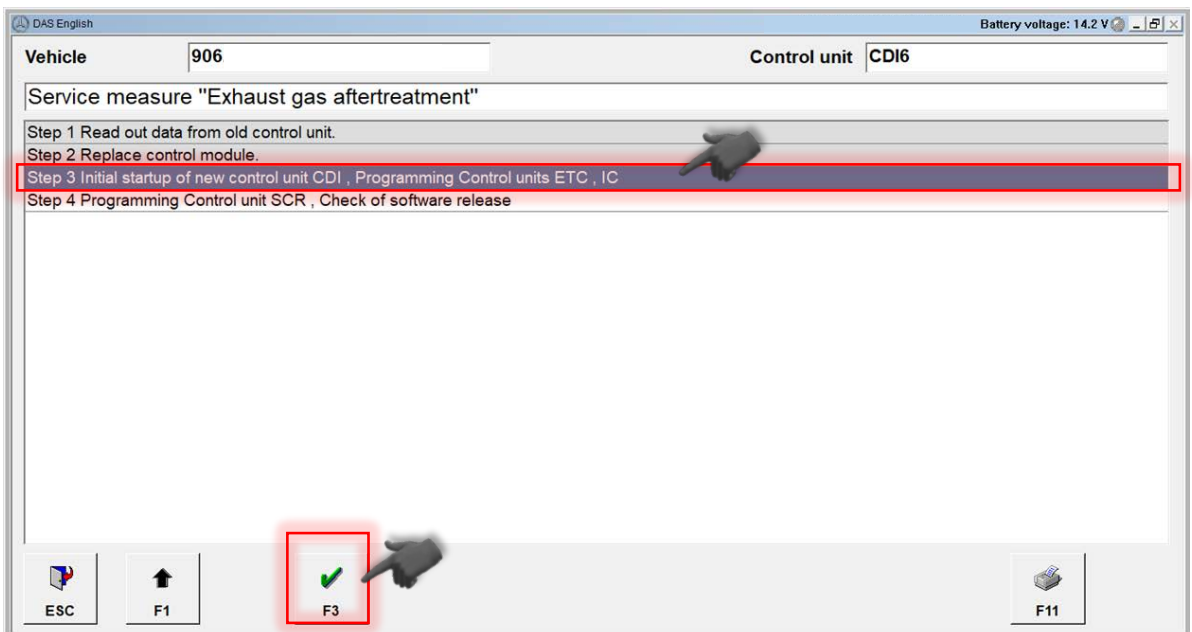
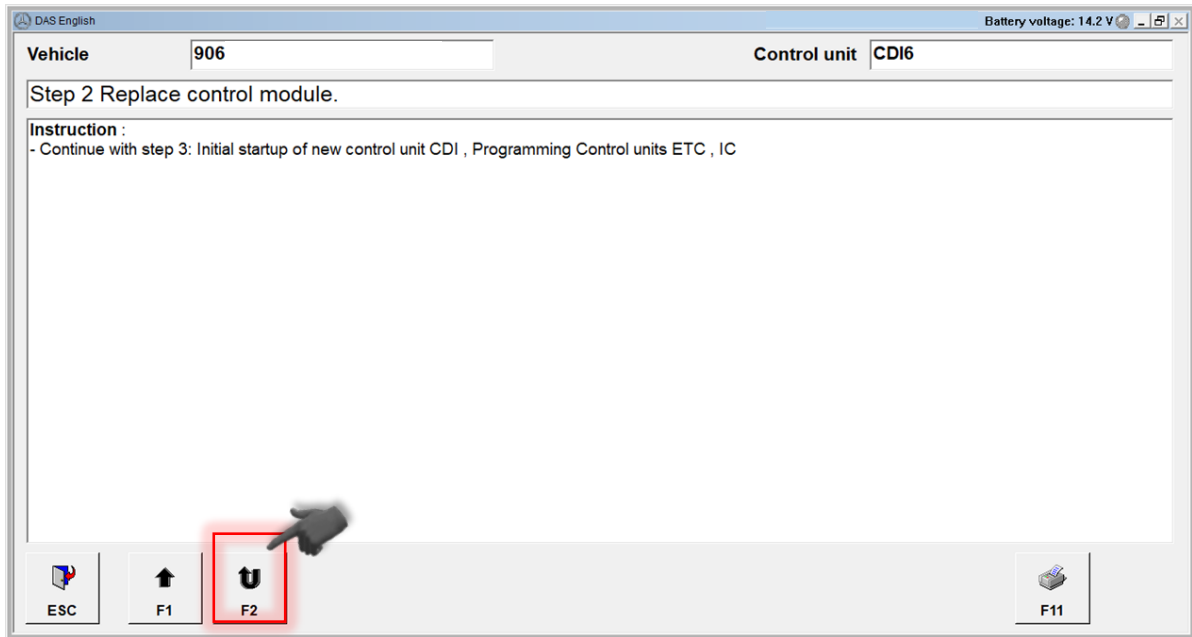

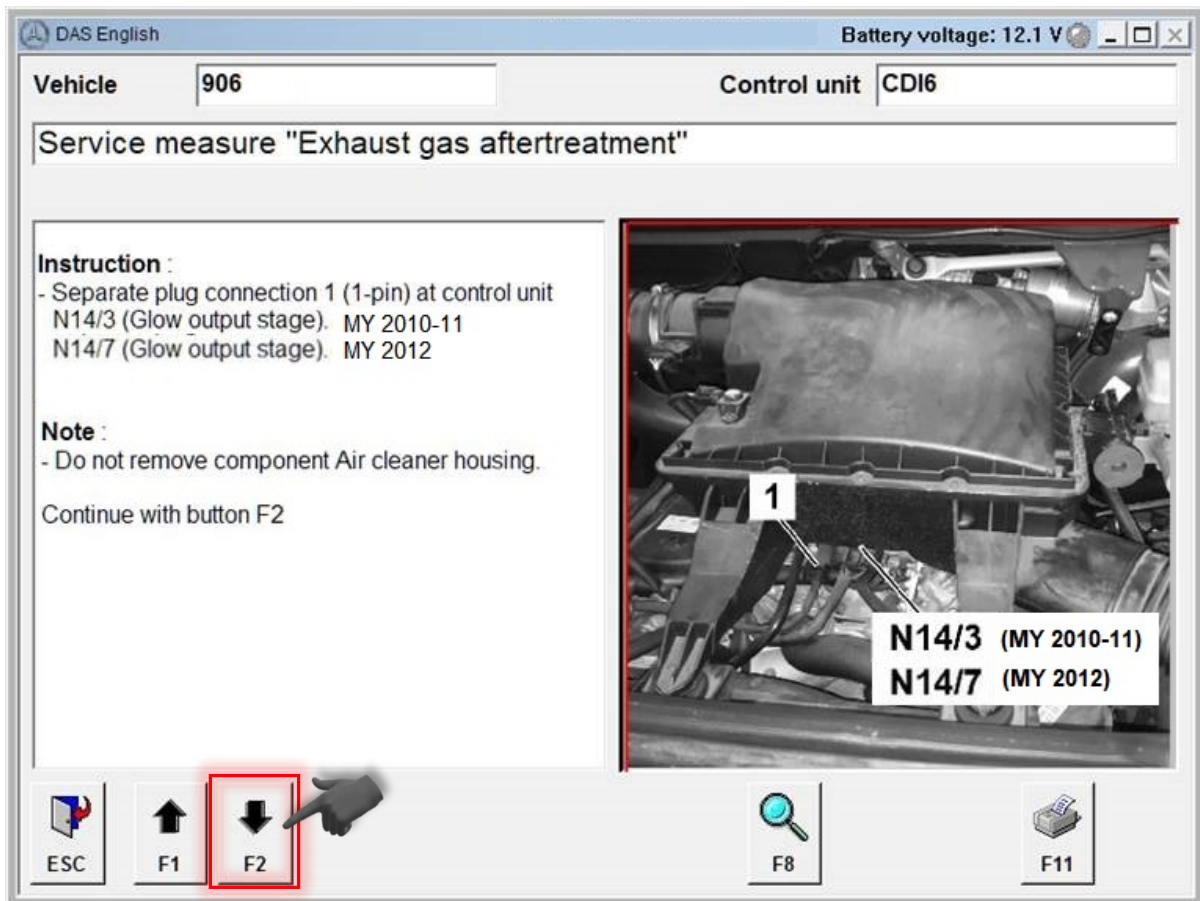

Connector 1 of glow output stage control unit (N14/3 on MY 2010-2011 or N14/7 on MY 2012) must be temporarily disconnected during the CDI initial startup procedure to help prevent pre-mature wear to steel glow plugs used on MY 2010-2012 Sprinter.



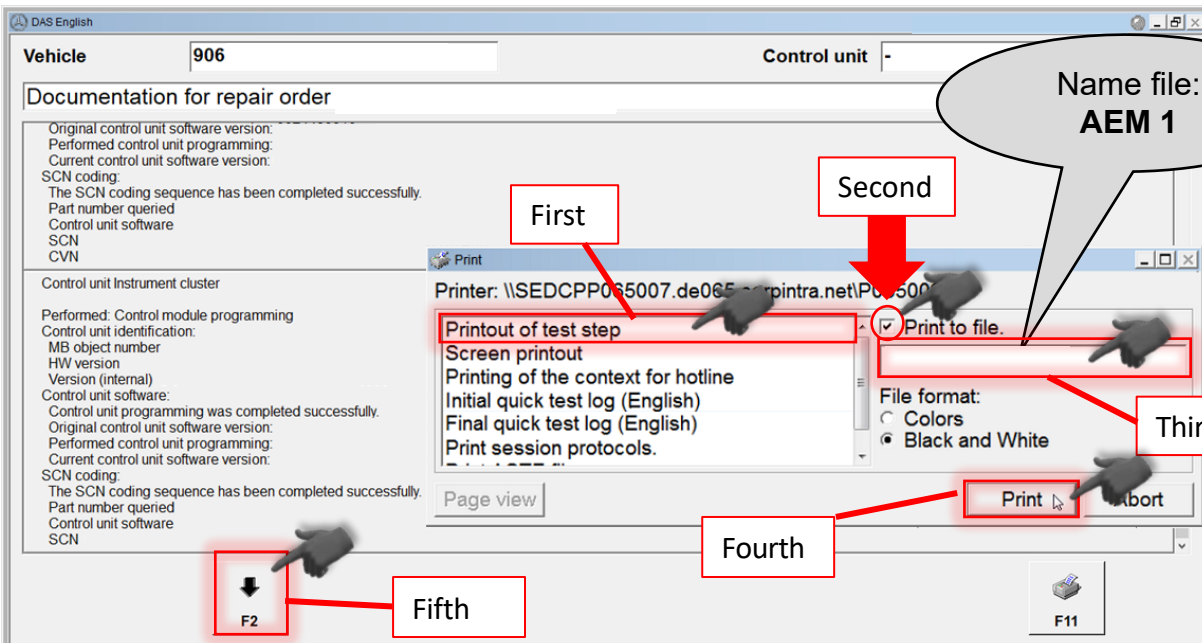
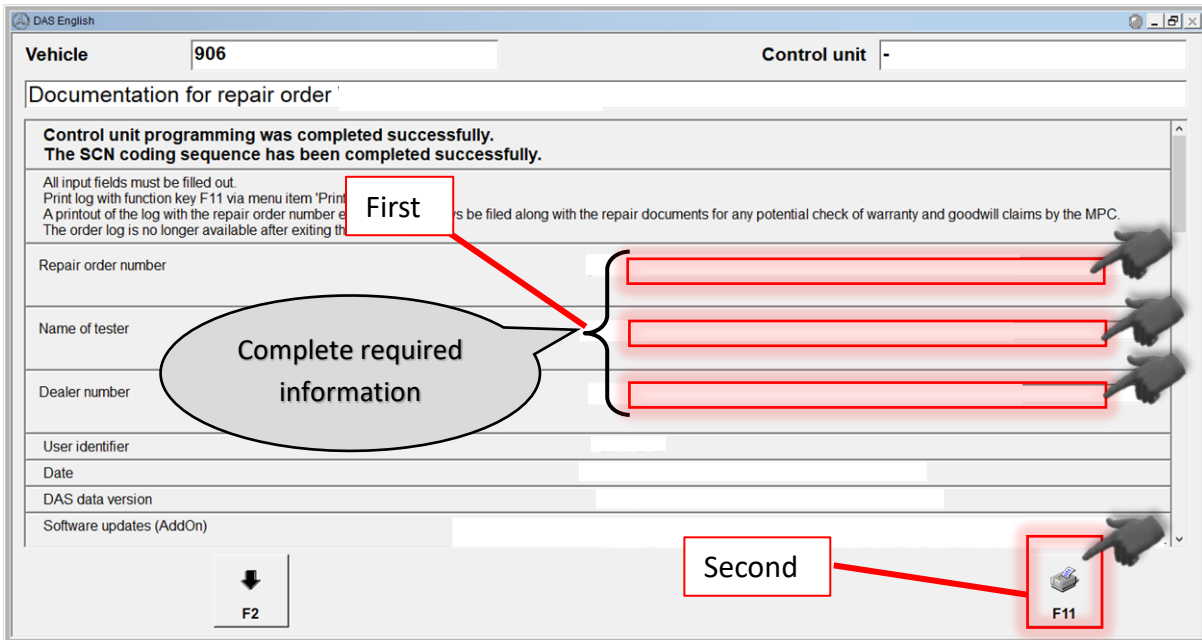

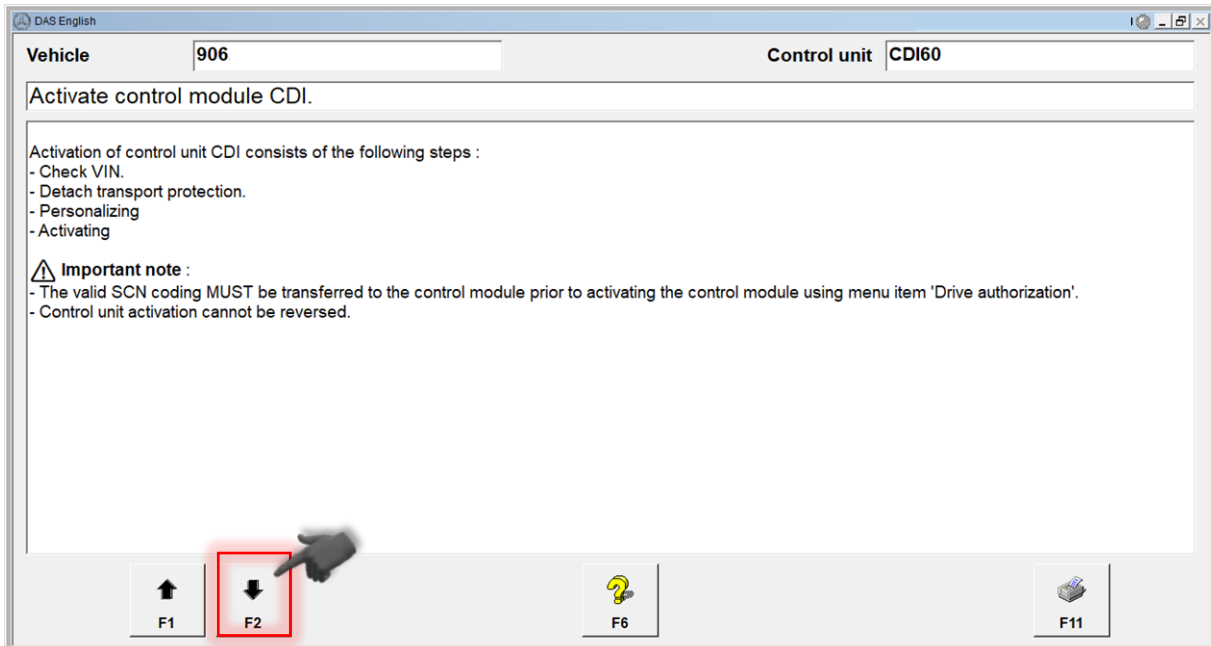

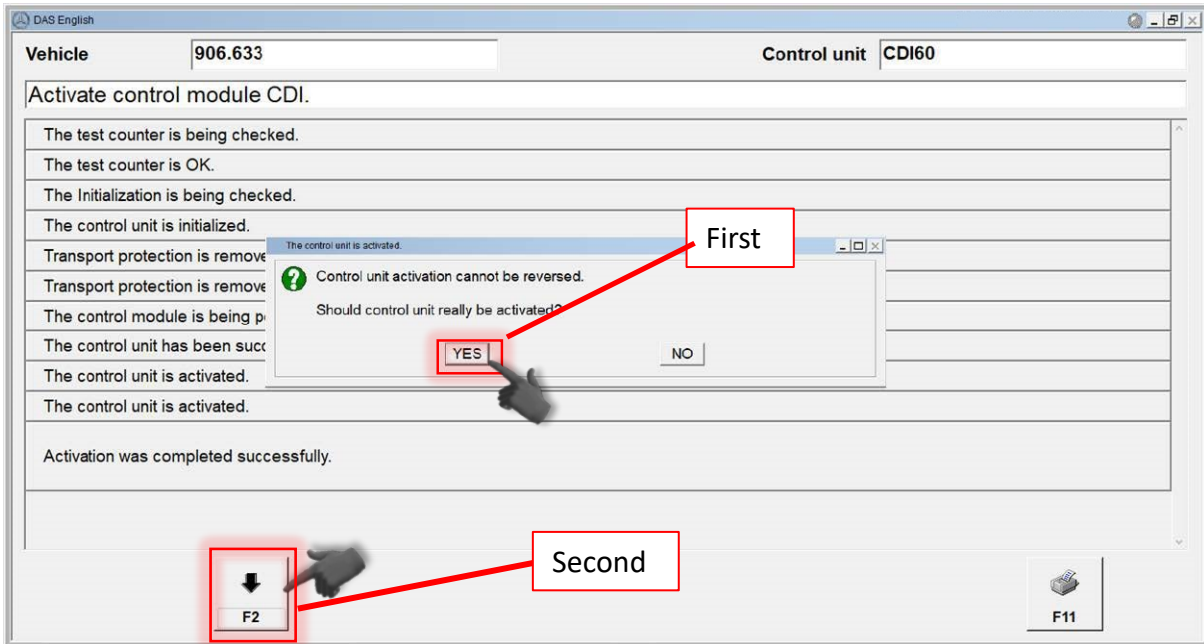

Connector 1 of glow output stage control unit (N14/3 on MY 2010-2011 or N14/7 on MY 2012) must be re-connected after CDI initial startup procedure.

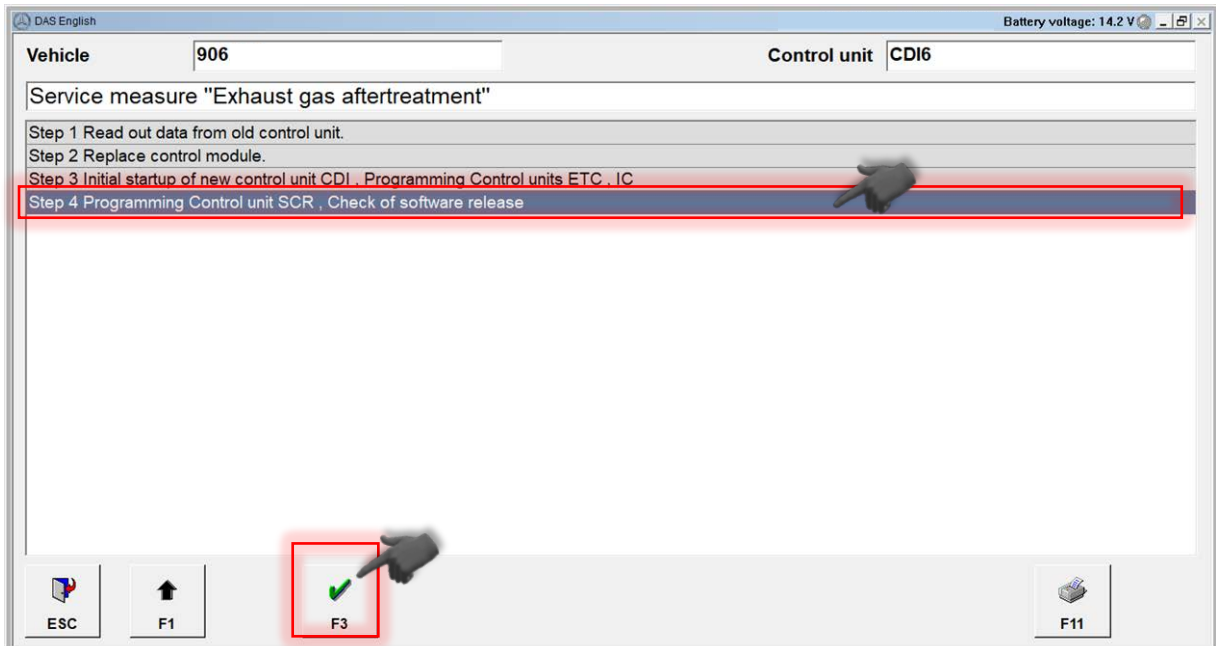
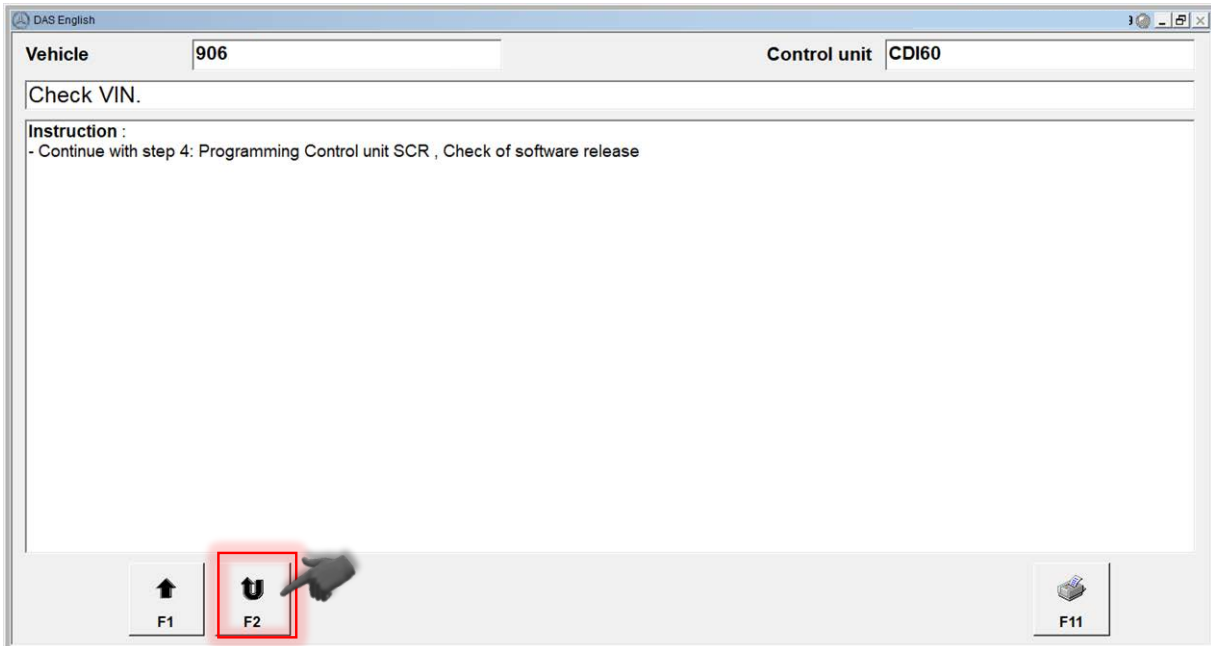

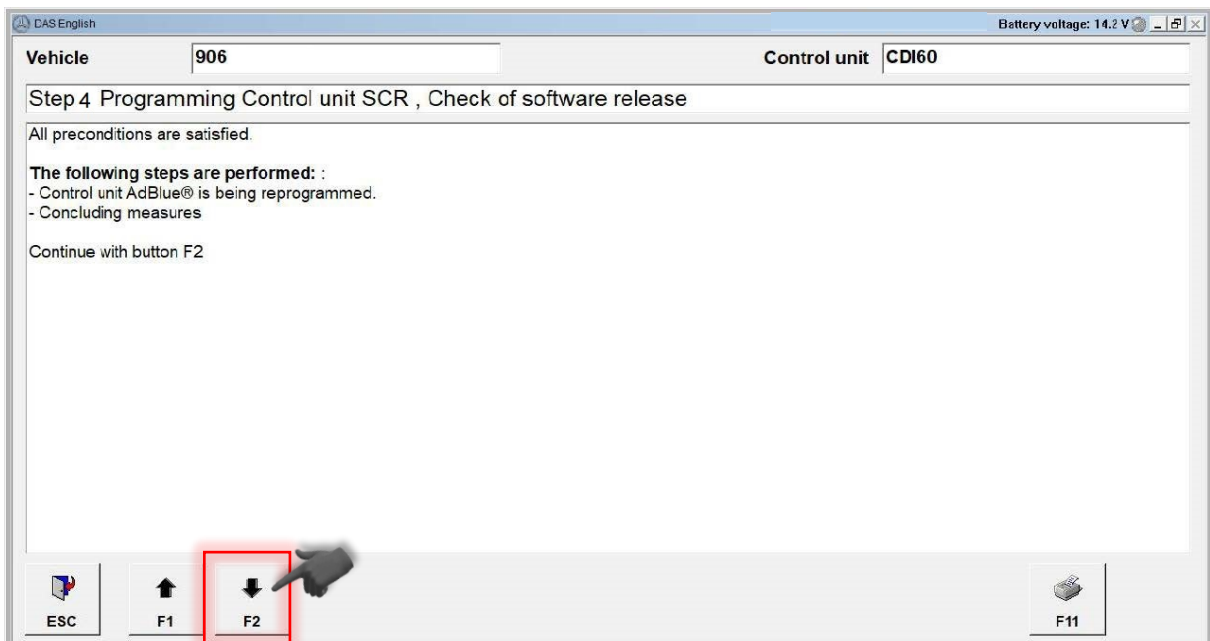
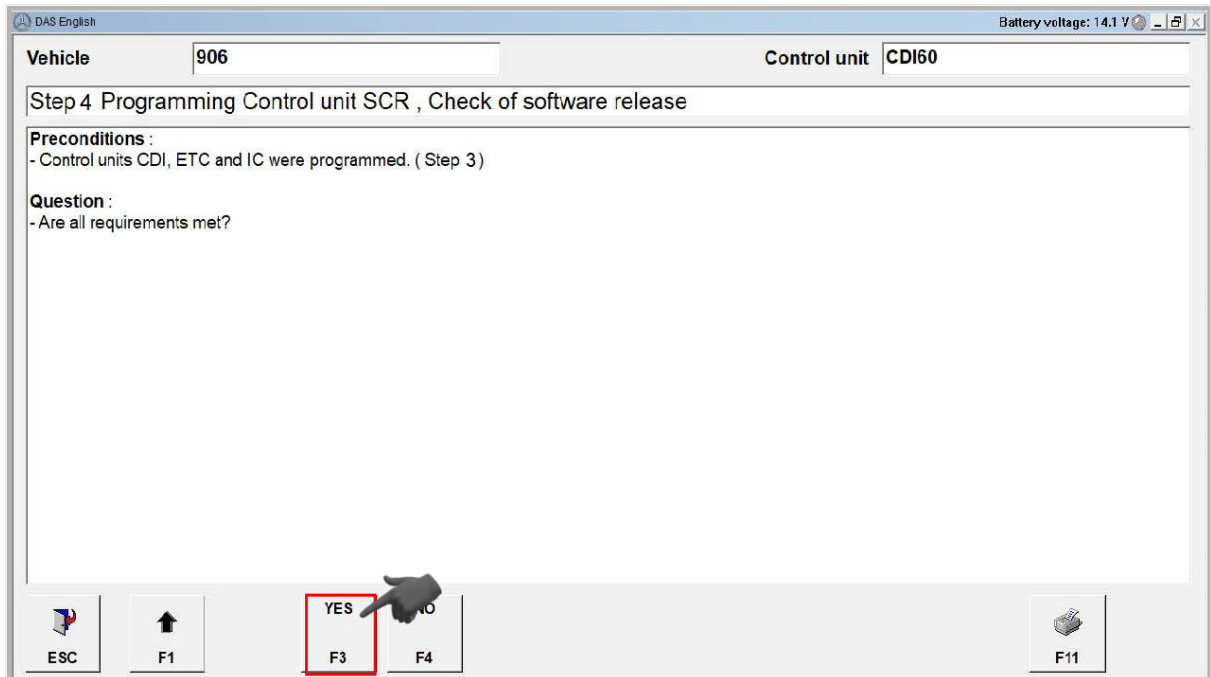

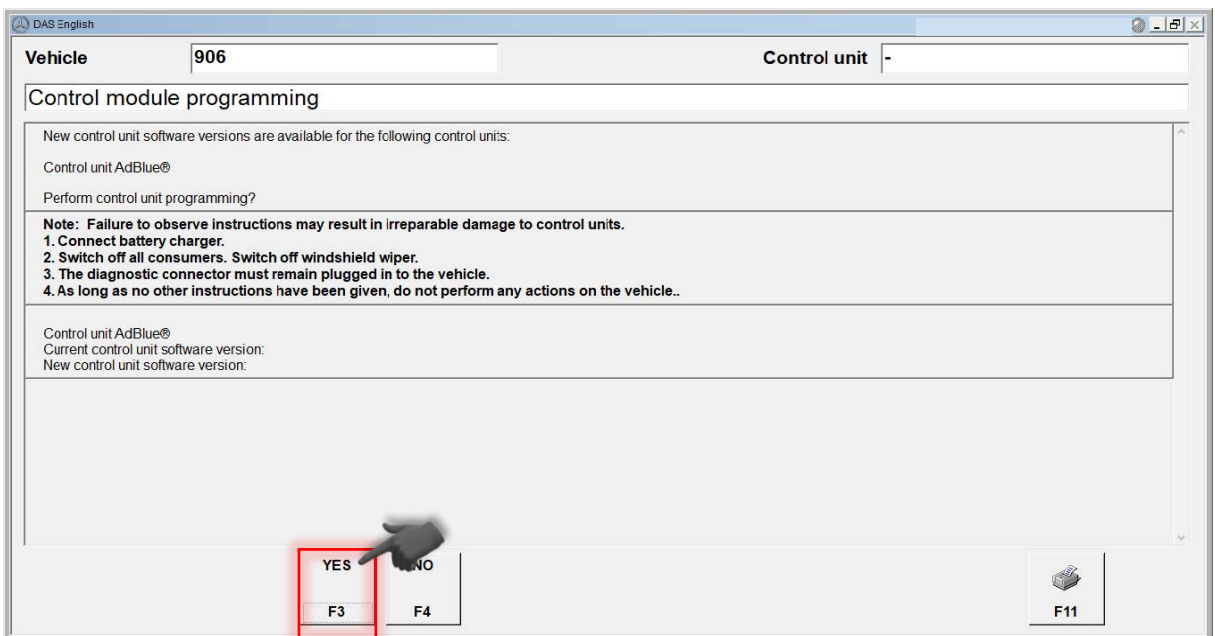
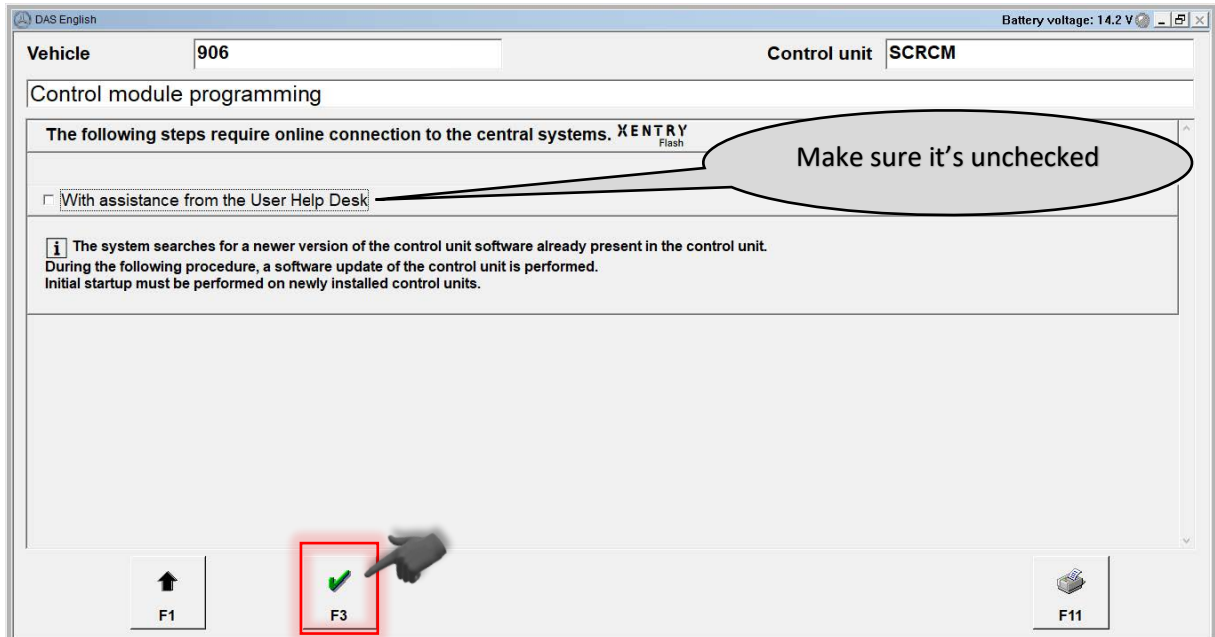

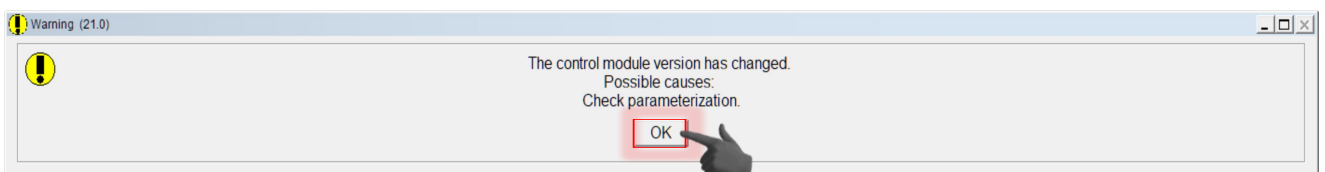
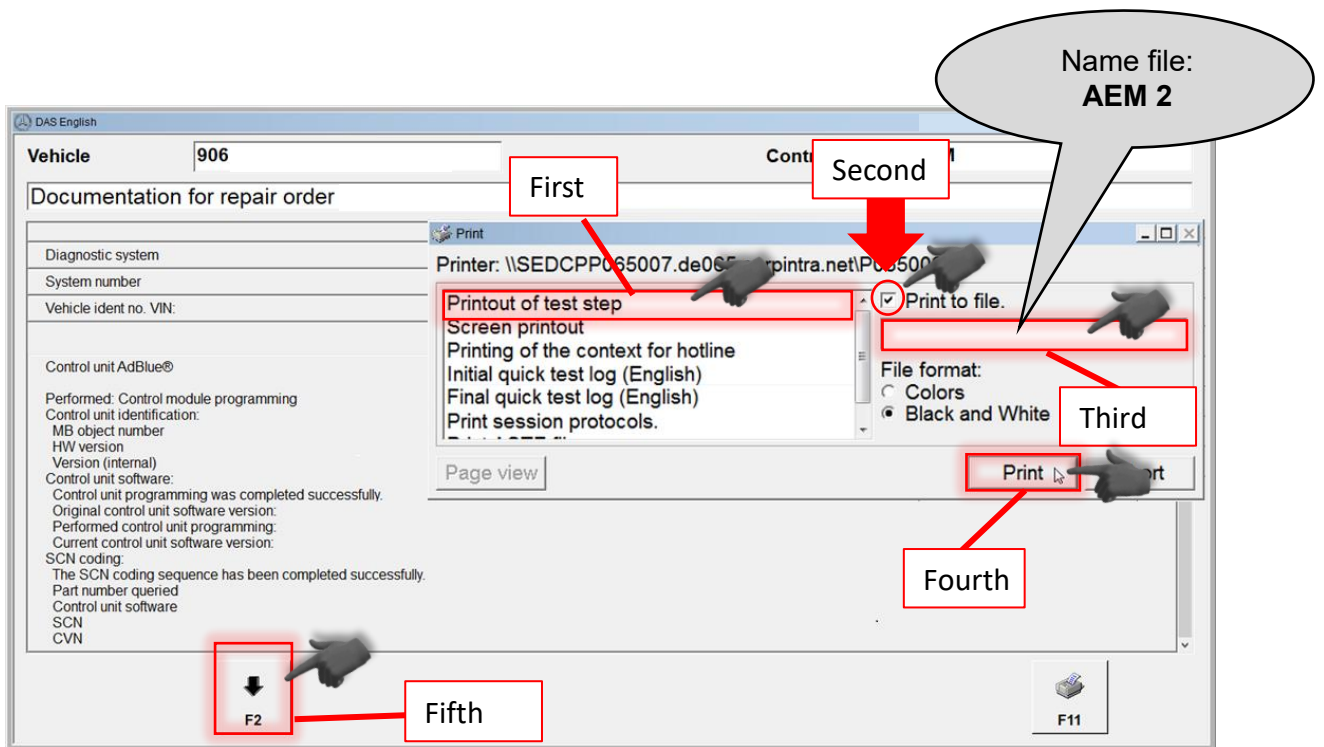
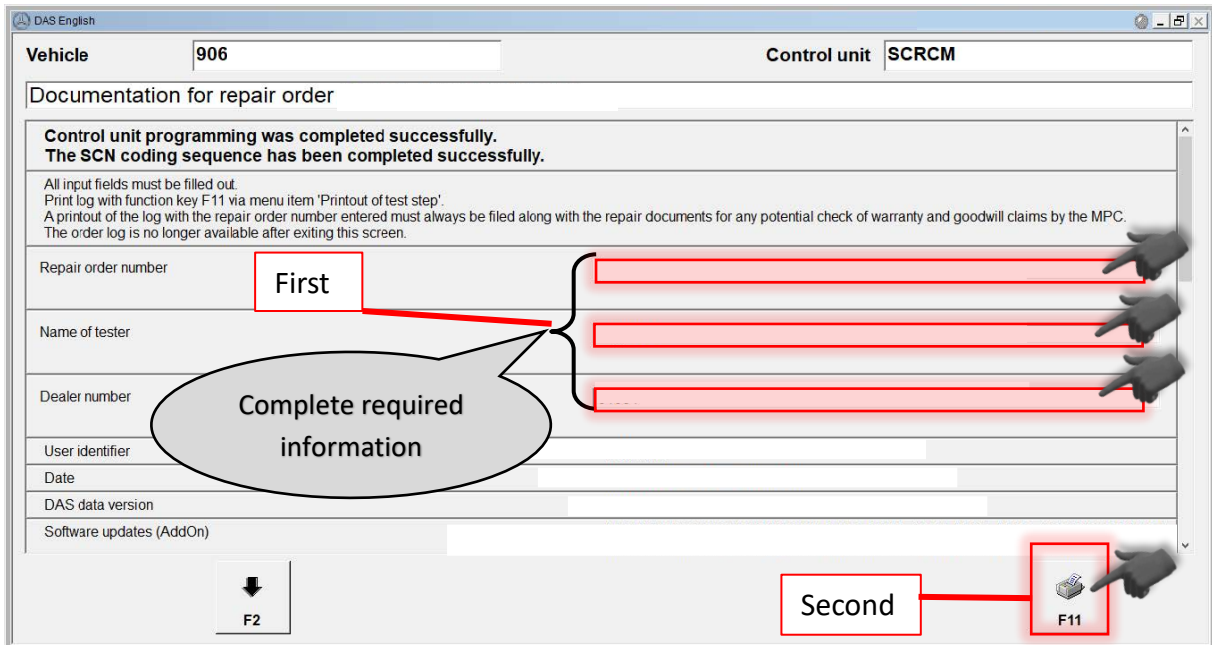

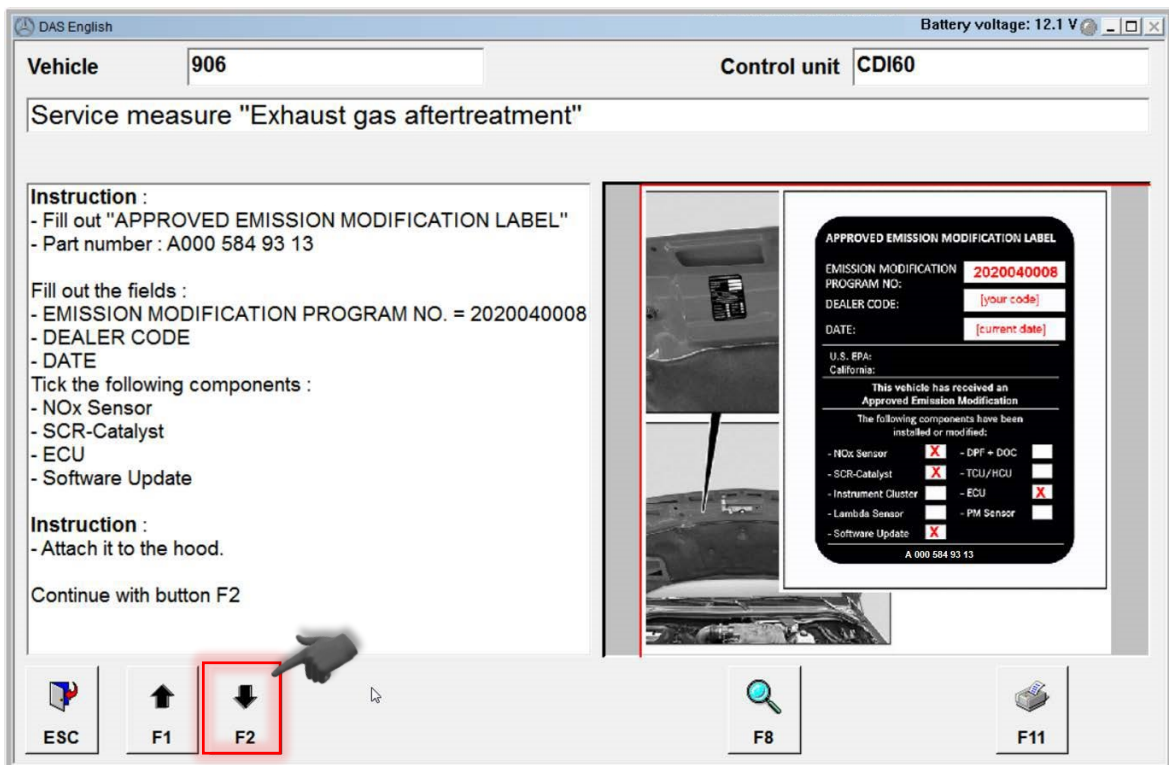

80

Complete the information on the APPROVED EMISSION MODIFICATION LABEL and attach it to the hood near the hood lock.



The attachment areas must be entirely free from dust and grease.

Otherwise, adequate adhesion cannot be ensured.



Fill in Emission Modification Program No., your dealer code, the date of the repair and mark the components that have been installed or modified. Use a black ultra fine point permanent marker.



A 000 584 93 13



Failure to comply may result in dealer debit and/or possible fines.

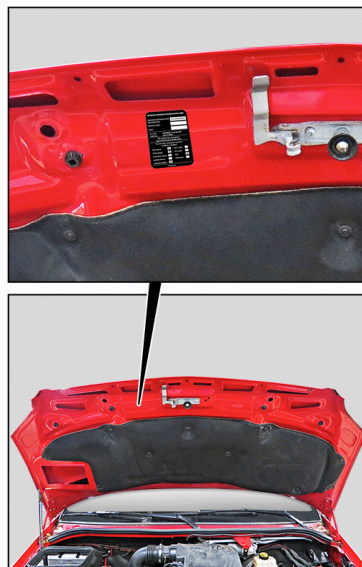

APPROVED EMISSION MODIFICATION LABEL	
EMISSION MODIFICATION PROGRAM NO:	2020040008
DEALER CODE:	
DATE:	
U.S. EPA: 40CFR§86.1816-08 HDV	
California: ULEV II MDV	
This vehicle has received an Approved Emission Modification	
The following components have been installed or modified:	
- NOx Sensor	<input checked="" type="checkbox"/> - DPF + DOC
- SCR-Catalyst	<input checked="" type="checkbox"/> - TCU/HCU
- Instrument Cluster	<input type="checkbox"/> - ECU
- Lambda Sensor	<input type="checkbox"/> - PM Sensor
- Software Update	<input checked="" type="checkbox"/>
A 000 584 93 13	

Vehicle: 906 Control unit: CDI60

Report

Service measure "Exhaust gas aftertreatment"
The procedure was completed successfully.

Verify Completed Successfully

Overview

N3/35 (CDI control unit)	OK
N141 (AdBlue® control unit)	OK
N15/3 (ETC [EGS] control unit)	OK
A1 (Instrument cluster)	OK
A97/1 (NOx sensor control unit upstream of SCR catalytic converter)	OK
A97/2 (NOx sensor control unit downstream of SCR catalytic converter)	OK
VeDoc Code OA3	OK
VeDoc Code OA0	OK
VeDoc Code OC2	OK

Details
N3/35 (CDI control unit)

Forward F2

F11



If the process was terminated incorrectly, repeat the process. If the fault persists, create a PTSS case.

Vehicle: 906 Control unit: CDI60

Report

Service measure "Exhaust gas aftertreatment"
The procedure was completed successfully.

Print dialog box:

- Printer: \\SEDCPP065007.de065.com\intra.net\Printer000
- Printout of test step
- Screen printout
- Printing of the context for hotline
- Initial quick test log (English)
- Final quick test log (English)
- Print session protocols.
- Print to file:
- File format: Colors Black and White
- Print Abort

First

Second

Third

Fourth

Fifth

Name file: AEM Results

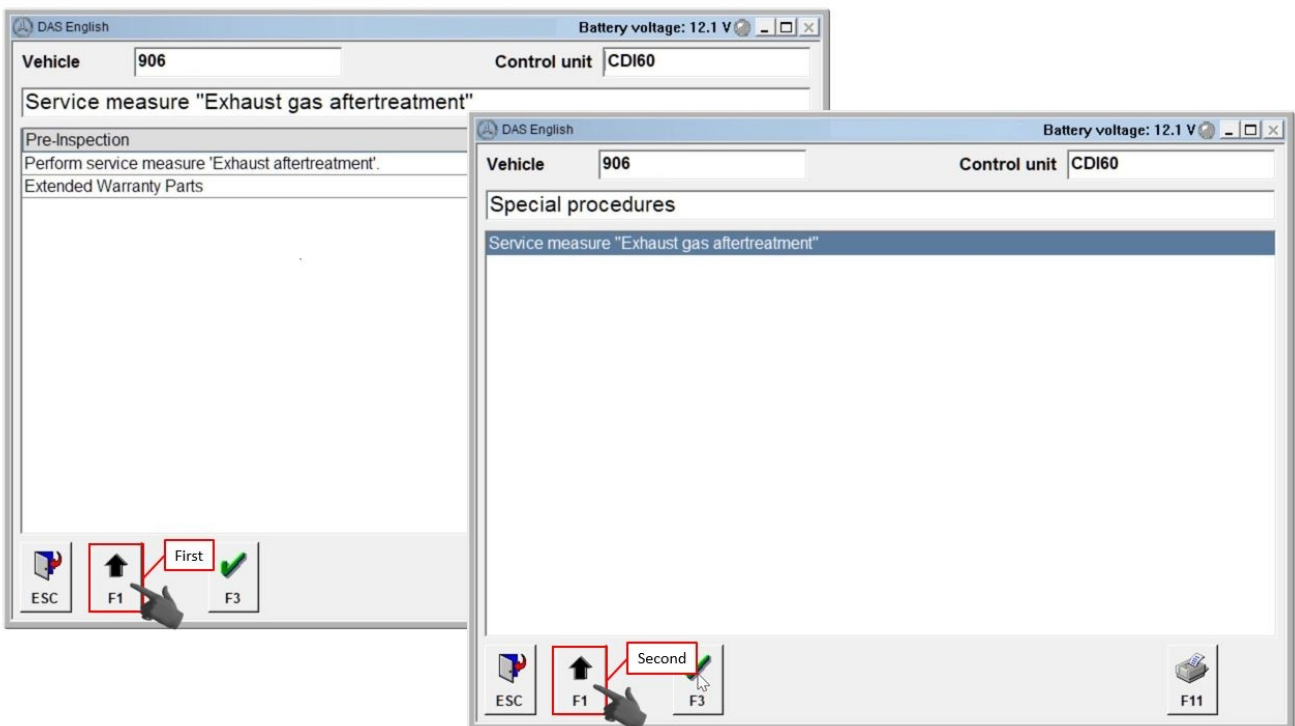
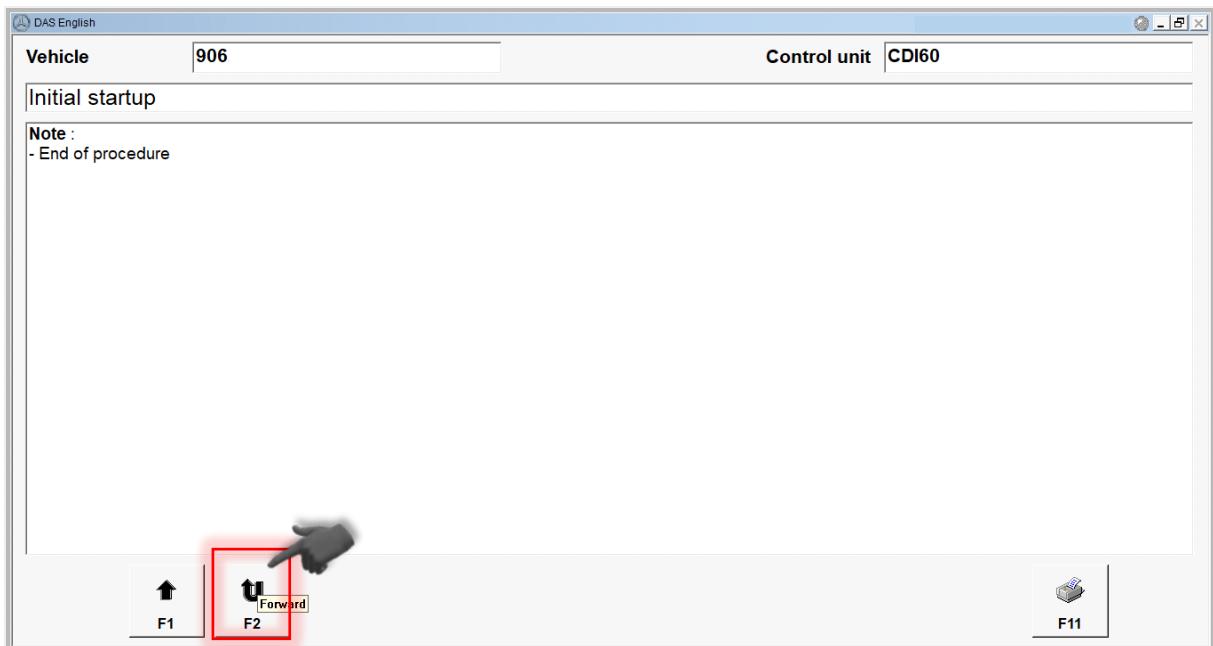

DAS English Battery voltage: 14.2 V

Vehicle **906.** Control unit **CDI6**

CDI6 Common Rail

- Control unit version
- Fault codes and events
- Actual values
- Actuations
- Initial startup
- Control unit adaptations
- Complete list of guided tests
- Complete list of fault codes
- Troubleshooting by means of complaints or symptoms
- Special procedures**
- Control unit log
- Order form for control unit replacement (event log 'Engine control unit')
- Diagnosis to plant specifications

ESC F1 F3 F6 F11

DAS English Battery voltage: 14.2 V

Vehicle **906.** Control unit **EZS906_NAFTA**

Drive

- CDI6 Common Rail Diesel Injection (OM642 EPA10)**
- CDI60 Common Rail Diesel Injection (OM642 EPA13)
- CDI4 Common Rail Diesel Injection (OM642 EPA07)
- EGS Electronic transmission control
- NAG2 Electronic transmission control
- EWM Electronic selector module
- FSCU Fuel pump
- SCR Control unit AdBlue®
- Readiness for exhaust emissions inspection (AU)

ESC F1 F3 F6 F11

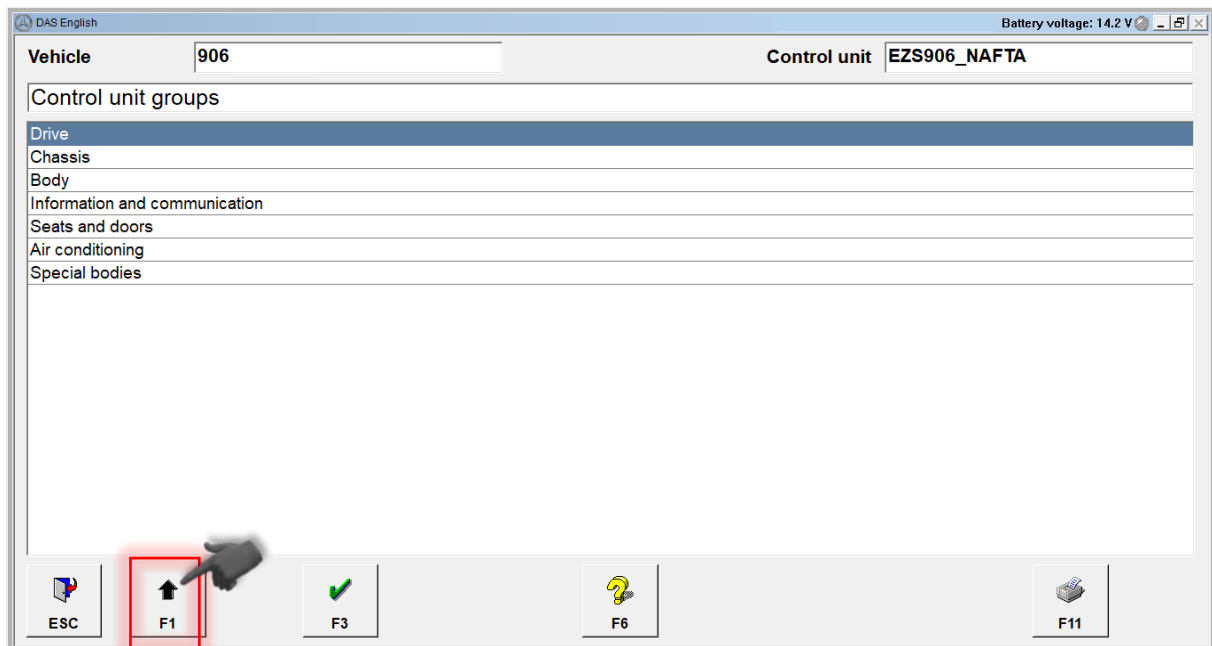

Final Quick Test

- 81 Perform a final quick test and upload to paperless pXD.



Faults stored in the memory must be deleted from the fault memory after completing the work.



If faults are current and stored in the updated control modules they need to be addressed. If technical hardships occur create a PTSS case.



The procedure via the diagnostic system is shown on the following pages.

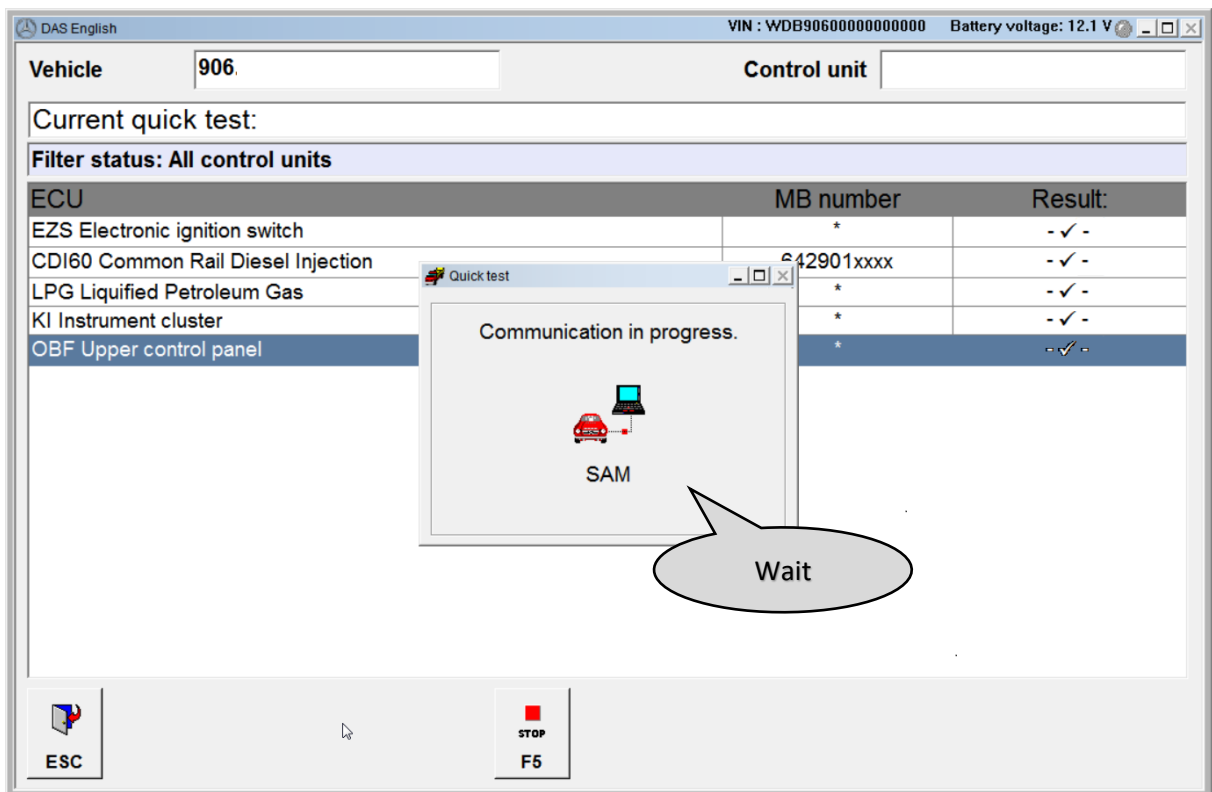
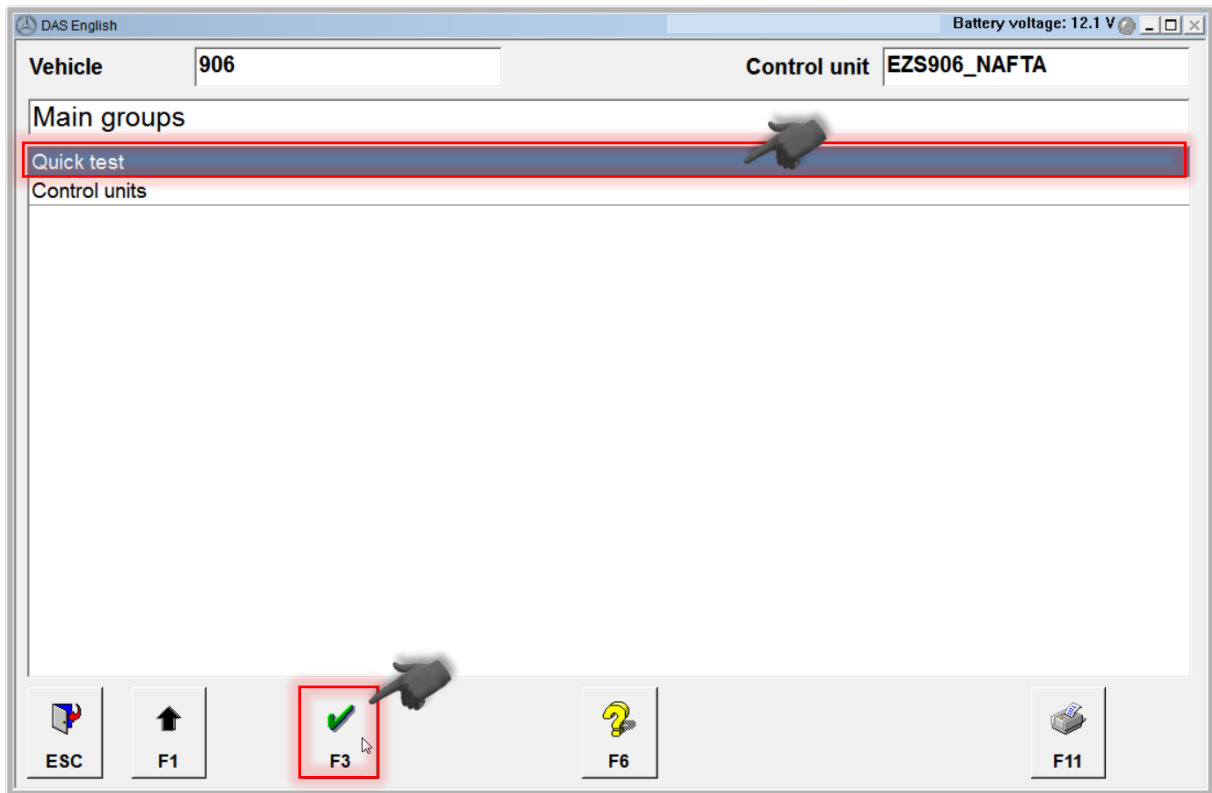



DAS English Battery voltage: 12.1 V

Vehicle: 906 Control unit:

Current quick test:

Filter status: All control units

ECU	MB number	Result:
CDI60 Common Rail Diesel Injection	642901xxxx	--✓--
SCR Control unit AdBlue®	*	--✓--
FSCM Fuel pump	*	--✓--
EZS Electronic ignition switch	*	--✓--
KI Instrument cluster	*	--✓--
OBF Upper control panel	*	--✓--
SAM Signal acquisition and actuation module	*	--✓--
TSG Door control module front driver side	*	--✓--
AAG2 Trailer connection unit	*	--✓--
DBE Overhead control panel	*	--✓--
ENR Electronic level control	*	--✓--
ESP Electronic stability program	*	--✓--
KE Keyless Entry	*	--✓--
KLA Automatic air conditioning/automatic temperature control	*	--✓--
LPG Liquefied Petroleum Gas	*	--✓--

ESC F1 F3 F4 F5 F6 F8 F9 F11

DAS English Battery voltage: 12.1 V

Vehicle: 906 Control unit:

Current quick test:

Filter status: All control units

ECU	MB number	Result:
CDI60 Common Rail Diesel Injection	642901xxxx	--✓--
SCR Control unit AdBlue®	*	--✓--
FSCM Fuel pump	*	--✓--
EZS Electronic ignition switch	*	--✓--
KI Instrument cluster	*	--✓--
OBF Upper control panel	*	--✓--
SAM Signal acquisition and actuation module	*	--✓--
TSG Door control module front driver side	*	--✓--
AAG2 Trailer connection unit	*	--✓--
DBE Overhead control panel	*	--✓--
ENR Electronic level control	*	--✓--
ESP Electronic stability program	*	--✓--
KE Keyless Entry	*	--✓--
KLA Automatic air conditioning/automatic temperature control	*	--✓--
LPG Liquefied Petroleum Gas	*	--✓--

Printer: \\SEDCP...e065.corpintra.net\F...000

Printout of test
Screen printout
Printing of the context for hotline
Initial quick test log (English)
Final quick test log (English)
Print session protocols.

File format:
Colors
Black and White

Page view Print Abort

Second

First

Third

Fourth

Name file: QT 2

ESC F1 F3 F4 F5 F6 F7 F8 F9 F11

82 End the DAS session

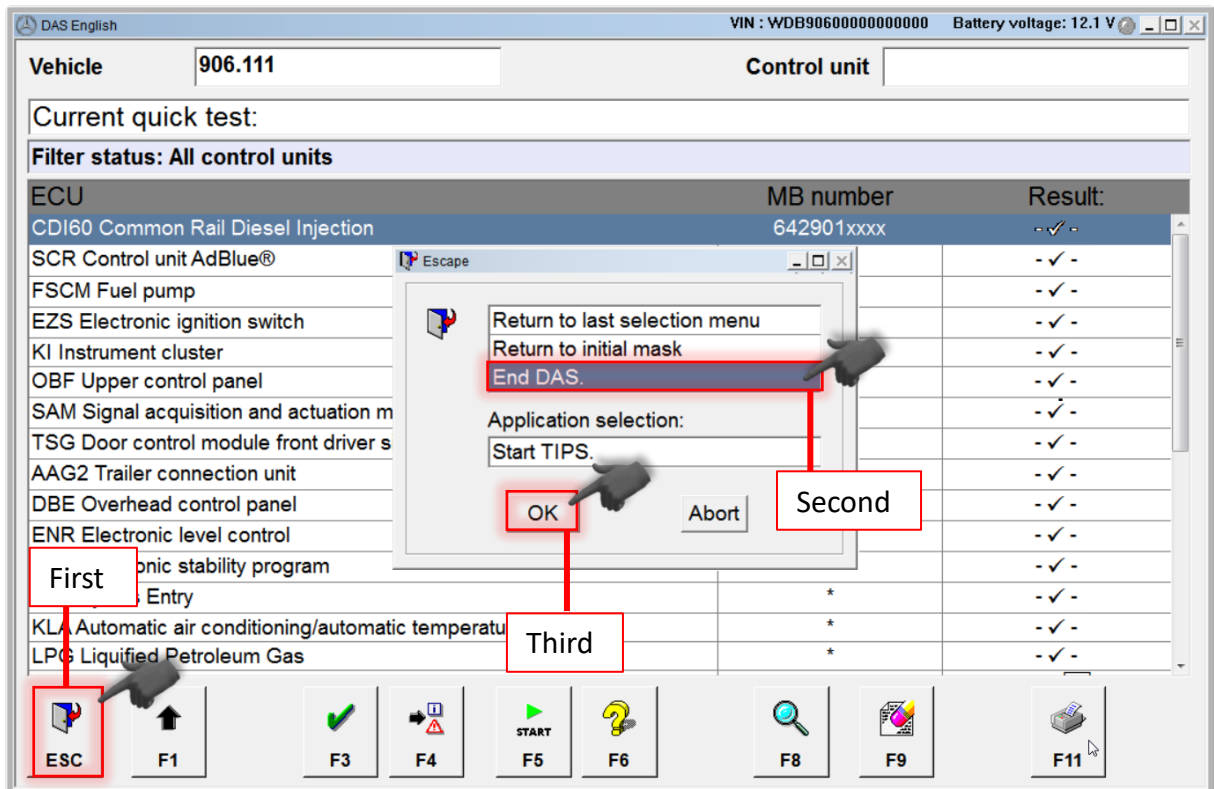

- 83 Switch off the ignition.
- 84 Disconnect the diagnosis system.
- 85 Connect any aftermarket devices that were connected to the X11/4 diagnostic socket before.
- 86 Disconnect the battery charger

Installation of auxiliary battery



The work steps 87 to 95 must only be carried out if an auxiliary battery is installed in the engine compartment.

- 87 Install the battery holder (42).



To do this, fasten the screws and install the nut. Battery holder on front wall: Torque to **20 Nm / 14.8 ft·lb** Battery holder on wheel arch: Torque to **8 Nm / 5.9 ft·lb**

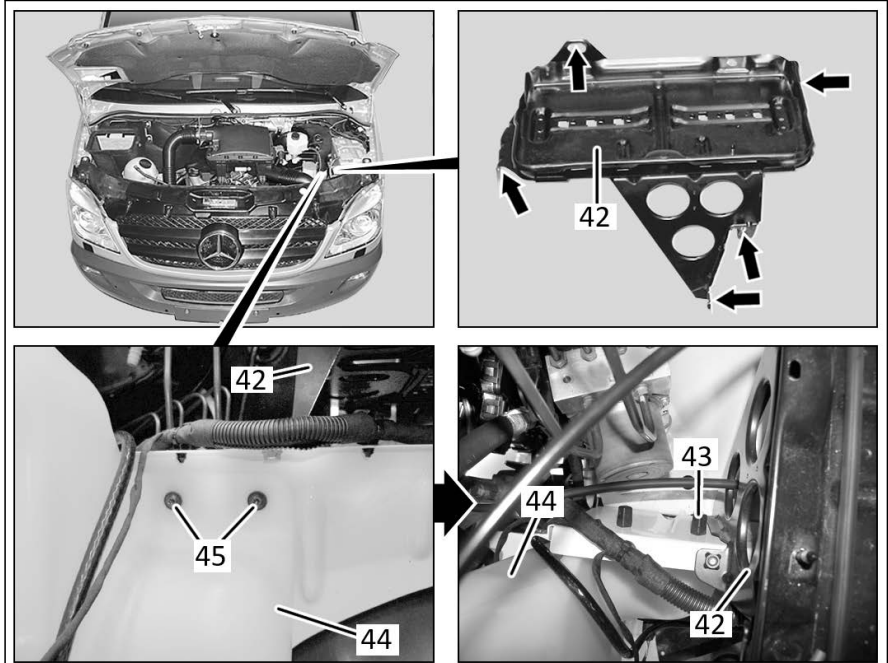

- 88 Install the threaded bushing (43).

- 89 Install the wash water reservoir (44).

- 90 Tighten the screws (45) in.

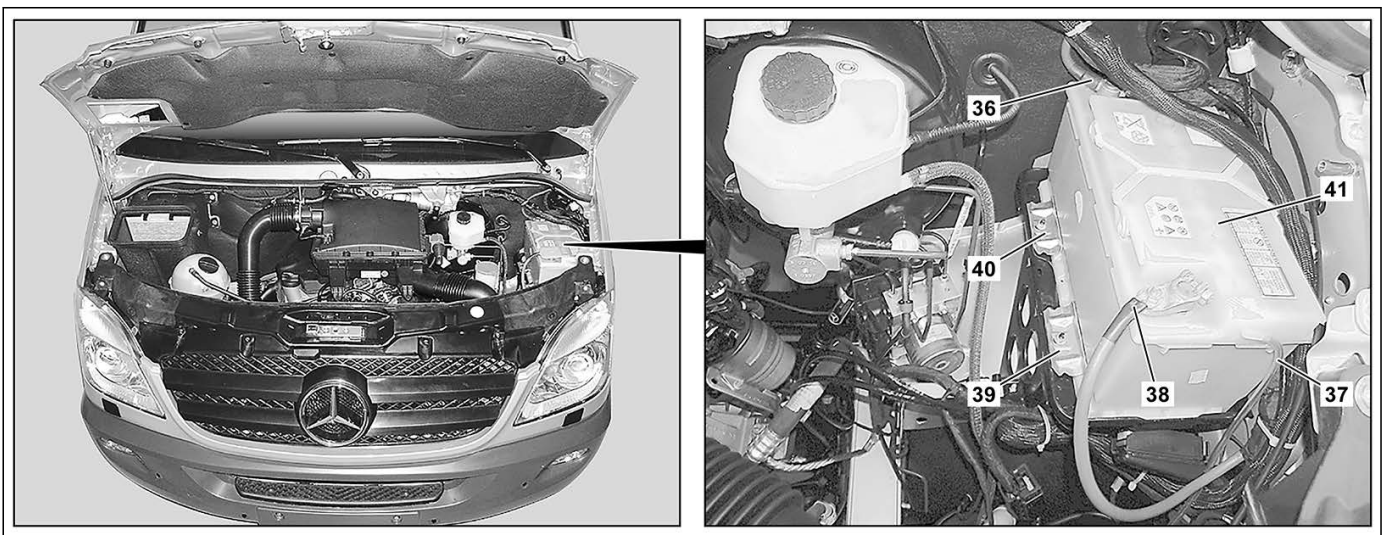

- 91 Lift the auxiliary battery (41) in place.

- 92 Install the holders (39, 40).

- 93 Install the venting line (37) on the auxiliary battery (41).

- 94 Install the plus line (36) on the auxiliary battery (41).

- 95 Install the ground line (38) on the auxiliary battery (41).

- 96 Close the hood.

**Replacement parts 2020040008**

Part No.	Designation	Quantity
A 906 490 36 00 80	SCR catalytic converter	1

Part No.	Designation	Quantity
A 642 905 20 00 85	NOx Sensor Package	1
A 642 900 97 01	Control Unit Diesel Injection System	1
A 906 995 02 02	Pipe Clamp	1
A 000 995 11 33	Profile Clamp	1
A 000 490 13 41	Clamp SCR/DPF	1
A 220 546 18 43	Mounting Tab	1
A 123 994 13 45	Spring Nut	1
A 000 994 32 11	Lock Pin	3
A 007 997 56 90	Cable Tie (with holding clip)	3
A 000 995 90 06	Cable Tie	1
N 000000 003477	Nut Fastener	4
A 207 492 00 00	Profile Seal	1
A 000 584 93 13	APPROVED EMISSION MODIFICATION LABEL	1