

Recall Bulletin 191125REV



RECALL BULLETIN:
191125REV

YEAR(S) AFFECTED:
2016-2020

PRODUCT(S) AFFECTED:

2016-2020 Fleetwood Bounder manufactured 3/20/2015 through 7/31/2019

2018-2020 Fleetwood Southwind manufactured 7/18/2017 through 7/24/2019

2016-2020 Holiday Rambler Vacationer manufactured 07/13/2015 through 07/31/2019

MODEL(S) AFFECTED:
See Affected Models at above right, paragraph 2

SUBJECT:
Inspection / Correction of Generator Exhaust Pipe Routing

KEYWORDS:
Exhaust, Generator

ISSUE DATE:
January 2020

© 2020 REV Recreation Group, Inc.

The purpose of this Recall Service Bulletin is to inform all REV Recreation Group dealers about the need to inspect the generator exhaust pipe routing on certain model year 2016-2020 Fleetwood Bounder, certain model year 2018-2020 Fleetwood Southwind and certain model year 2016-2020 Holiday Rambler Vacationer motorhomes, to ensure the exhaust pipe does not intrude into the departure angle of the coach. If the generator exhaust pipe is improperly routed, it will need to be replaced with a different exhaust pipe.

Affected Models: 33C, 33CT, 34C, 34ST, 34T, 35K, 35DK, 35P, 36E, 36H, 36P, 36X, 36Y, 37BH and 37H. **No other models are affected.**

The lists of affected motorhomes and required replacement parts appear at the end of this Bulletin.

CONDITION:

Motorhomes affected by this recall may have the generator exhaust pipe routed in a manner that causes it to exit within the departure angle. This could cause the exhaust pipe to become damaged or sheared off if the vehicle is driven on an incline, potentially allowing carbon monoxide from generator exhaust emissions to enter the vehicle, which could result in illness or death.

PROCEDURES:



Dealers are required obtain Prior Authorization and to call REV Dealer Technical Support to before beginning any work and after the unit is in their bay. You will receive instructions and will be provided any necessary part ordering information.

**Fleetwood Dealer Technical Support: (800) 816-9825
Holiday Rambler Dealer Technical Support: (877) 332-9239**

- **READ THIS ENTIRE BULLETIN CAREFULLY BEFORE PROCEEDING AND FOLLOW ALL SAFETY PRECAUTIONS.**
- **Review the list of affected units at the end of this bulletin to ensure the motorhome you are inspecting is part of this campaign.**
- **Take a copy of this bulletin with you when servicing the unit.**



• PHOTOS WILL BE REQUIRED FOR THE FOLLOWING PROCEDURES. READ PHOTO REQUIREMENTS CAREFULLY. INSUFFICIENT PHOTO DOCUMENTATION MAY RESULT IN CLAIM DENIAL

- **If there are any questions after reviewing the entire procedure, contact REV Dealer Technical Support.**

This bulletin is supplied for technical information only and is not an authorization for repairs.

Federal law (section 154 of the national traffic and motor vehicle safety act of 1966) requires that: If you have received a notice of recall or failure to comply from REV Recreation Group or any component Manufacturer, you must repair or otherwise correct the defects on vehicles remaining in your inventory, according to the notification, before selling or leasing the vehicles. Any vehicle lessor receiving this recall notice must forward a copy of the notice to the lessee within ten days.

"It is impossible to know, evaluate and advise the service trade of all conceivable ways in which service might be done or of the possible hazardous consequences of each way. Accordingly, anyone who uses a service procedure or tool must first assure that neither personal safety nor vehicle safety will be jeopardized by the selected service methods."

WARNING

- KEEP CLEAR OF ALL PINCH POINTS WHEN WORKING UNDER A MOTORHOME.
- THE LEVELING JACKS SHOULD NOT SUPPORT ANY WEIGHT OF THE MOTORHOME WHILE WORK IS PERFORMED. FAILURE TO FOLLOW THIS WARNING MAY RESULT IN PERSONAL INJURY.
- DO NOT WORK UNDER AN ELEVATED MOTORHOME UNLESS IT IS SUPPORTED BY A HOIST OR WITH JACK STANDS CAPABLE OF SUPPORTING ITS WEIGHT.
- HEED ALL PRECAUTIONS AND USE APPROPRIATE PERSONAL PROTECTIVE EQUIPMENT TO AVOID INJURY.

IMPORTANT NOTE:

This procedure contains the evaluation and repair for two distinctly different floor plan groups, 35P/36P models and non-35/36P models. Please verify which floor plan you are working on prior to proceeding.

INSPECTION / EVALUATION - ALL MODELS

1. Park the motorhome on dry, level pavement. Place the transmission into PARK and set the parking brake.
2. Turn off the ignition and remove the ignition key. Maintain control of the ignition key until all repairs are completed. Attach a notice, "DO NOT USE", to the generator switch in order to avoid activation of the system.
3. Block wheels to prevent movement.

This bulletin is supplied for technical information only and is not an authorization for repairs.

Federal law (section 154 of the national traffic and motor vehicle safety act of 1966) requires that: If you have received a notice of recall or failure to comply from REV Recreation Group or any component Manufacturer, you must repair or otherwise correct the defects on vehicles remaining in your inventory, according to the notification, before selling or leasing the vehicles. Any vehicle lessor receiving this recall notice must forward a copy of the notice to the lessee within ten days.

"It is impossible to know, evaluate and advise the service trade of all conceivable ways in which service might be done or of the possible hazardous consequences of each way. Accordingly, anyone who uses a service procedure or tool must first assure that neither personal safety nor vehicle safety will be jeopardized by the selected service methods."

INSPECTION / EVALUATION (continued)

4. Locate the generator exhaust pipe on the driver's side rear area of the coach, and determine whether it exits in the area of the departure angle by using the following string method:

- a) Using a heavy gauge string (e.g. chalk line or mason line), wedge or hook one end under the point where the rear tire contacts the ground.
- b) Have an assistant pull the string tight and hold it against the lowest point on the trailer hitch skid plate; see Figure 1.



Figure 1

This will create a wedge with the ground surface as shown in Figure 2. The gray shaded area is the departure angle.

- c) Bend or squat down and look at the generator exhaust at eye level.

IMPORTANT: Observing this area at eye level is critical to the evaluation.

- d) While at eye level, observe whether the generator pipe is above the departure angle (above the string) or in the departure angle (below the string). Refer to Figure 2.

SEE NEXT PAGE FOR PHOTO REQUIREMENTS

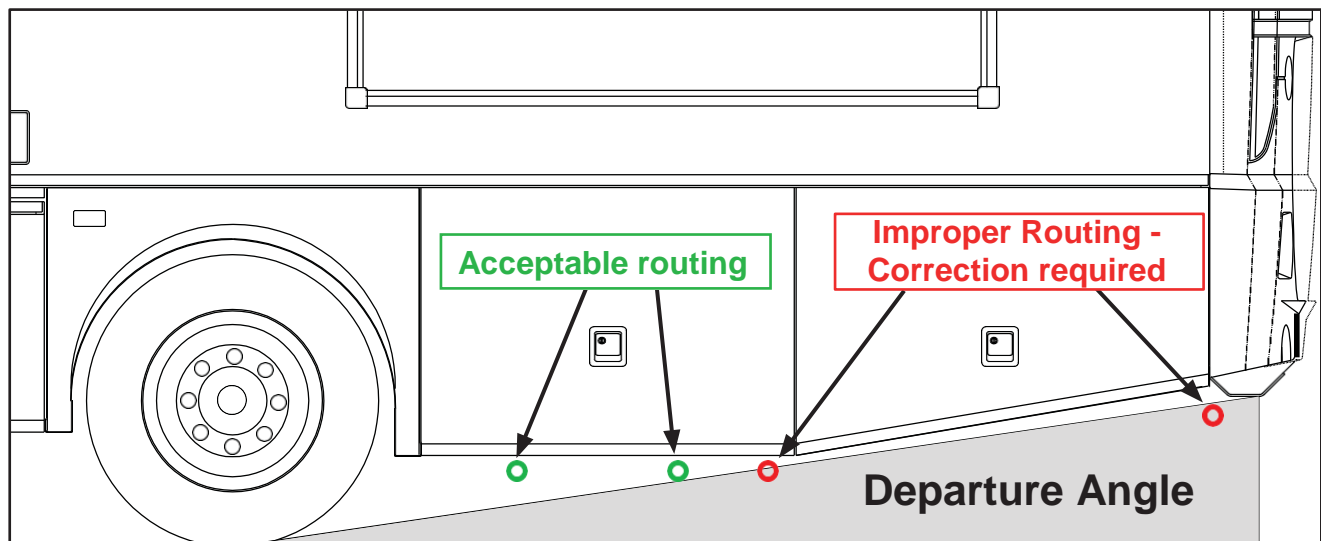

Figure 2

This bulletin is supplied for technical information only and is not an authorization for repairs.

Federal law (section 154 of the national traffic and motor vehicle safety act of 1966) requires that: If you have received a notice of recall or failure to comply from REV Recreation Group or any component Manufacturer, you must repair or otherwise correct the defects on vehicles remaining in your inventory, according to the notification, before selling or leasing the vehicles. Any vehicle lessor receiving this recall notice must forward a copy of the notice to the lessee within ten days.

"It is impossible to know, evaluate and advise the service trade of all conceivable ways in which service might be done or of the possible hazardous consequences of each way. Accordingly, anyone who uses a service procedure or tool must first assure that neither personal safety nor vehicle safety will be jeopardized by the selected service methods."



PHOTO REQUIREMENTS

5. Kneel down and take several photos of the generator exhaust pipe location both from the eye level view as well as from slightly below the coach, clearly showing whether the exhaust pipe exits within the departure angle. Be sure at least one photograph includes the area from the centerline of the rear tire to the rear bumper. Refer to Figure 2 on the previous page for examples of proper and improper routing.

- a) If the evaluation shows that the generator exhaust pipe is not in the departure angle, the photos **must** be submitted with the repair claim in REV RV's warranty portal; use flat rate code 6090-11, "Inspected/Not Defective". No further work is required.
- b) If the evaluation shows that the generator exhaust pipe is in the departure angle, it will need to be replaced. "Before" and "after" photos will be required. Take several clear photos prior to beginning repairs showing the improper routing; the photos **must** be attached to a draft claim in the dealer warranty portal (A.D.N.). After receiving approval to proceed with repairs, perform the Repair Procedure beginning at Step 6.

After completing repairs, take several photos that clearly display the corrected routing of the generator exhaust. **Both sets of photos** ("before" and "after") **must** be attached to the repair claim in REV RV's warranty portal; use flat rate code 6090-12, "Inspected/Defective/Repaired".

REPAIR PROCEDURE

- 6. Referring to Figure 3, find and remove the generator exhaust hanger bracket located near the sidewall. After the exhaust hanger is loose from the pipe, locate the upper fastener securing the hanger to the coach. Remove it and set the exhaust hanger aside for possible reinstallation.
- 7. With the exhaust hanger removed, locate and remove the fasteners holding the exhaust guard to the motorhome. See Figure 4. Set the exhaust guard aside for possible reinstallation.

Note: If the exhaust guard is damaged or missing it will need to be replaced. See part ordering information on Page 9 of the bulletin.

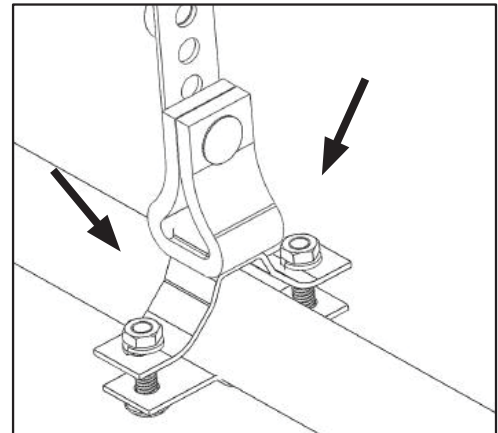

Figure 3



Figure 4

This bulletin is supplied for technical information only and is not an authorization for repairs.

Federal law (section 154 of the national traffic and motor vehicle safety act of 1966) requires that: If you have received a notice of recall or failure to comply from REV Recreation Group or any component Manufacturer, you must repair or otherwise correct the defects on vehicles remaining in your inventory, according to the notification, before selling or leasing the vehicles. Any vehicle lessor receiving this recall notice must forward a copy of the notice to the lessee within ten days.

"It is impossible to know, evaluate and advise the service trade of all conceivable ways in which service might be done or of the possible hazardous consequences of each way. Accordingly, anyone who uses a service procedure or tool must first assure that neither personal safety nor vehicle safety will be jeopardized by the selected service methods."

8. At the generator, use a ratchet and socket to remove the U-bolt exhaust clamp that holds the generator exhaust pipe to the generator flange. See Figure 5.

9. **For 35P & 36P models only:**

If equipped, remove the heat shield retaining U-bolts in order to release the plumbing strap exhaust hangers. Also, locate and remove the upper fastener(s) attaching the plumber's strap to the chassis framework.

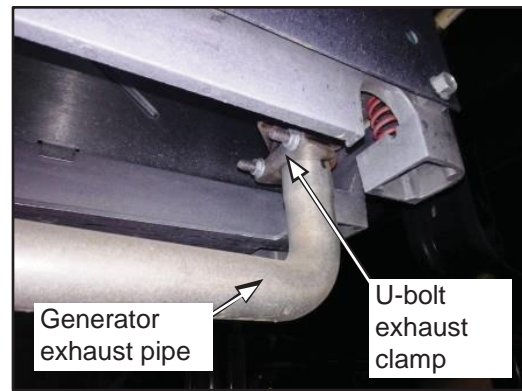

Figure 5

10. With all of the fasteners and hardware removed, detach the generator exhaust pipe from the coach. Retain the flat washers for reuse in a later step. Dispose of the exhaust pipe, bolts and locknuts. Also dispose of the heat shield and its fasteners. A heat shield will not be required for use with the replacement exhaust pipe specified in the Parts list (page 9) for Model(s) 35P or 36P.

Based on the model of coach you are working on, refer to the following specifications to identify which remaining repair steps must be followed:

- All models except 35P & 36P - Perform Steps 11-16
- Models 35P & 36P only - Perform Steps 17-24

Repair Steps for all affected models other than 35P and 36P

Ensure all needed parts are on hand before beginning. Refer to Parts List "A" on Page 9.

11. Begin reinstallation by installing the new exhaust heat shield onto the new generator exhaust pipe using (two) 1 1/2" I.D. exhaust clamps in the location shown in Figure 6.

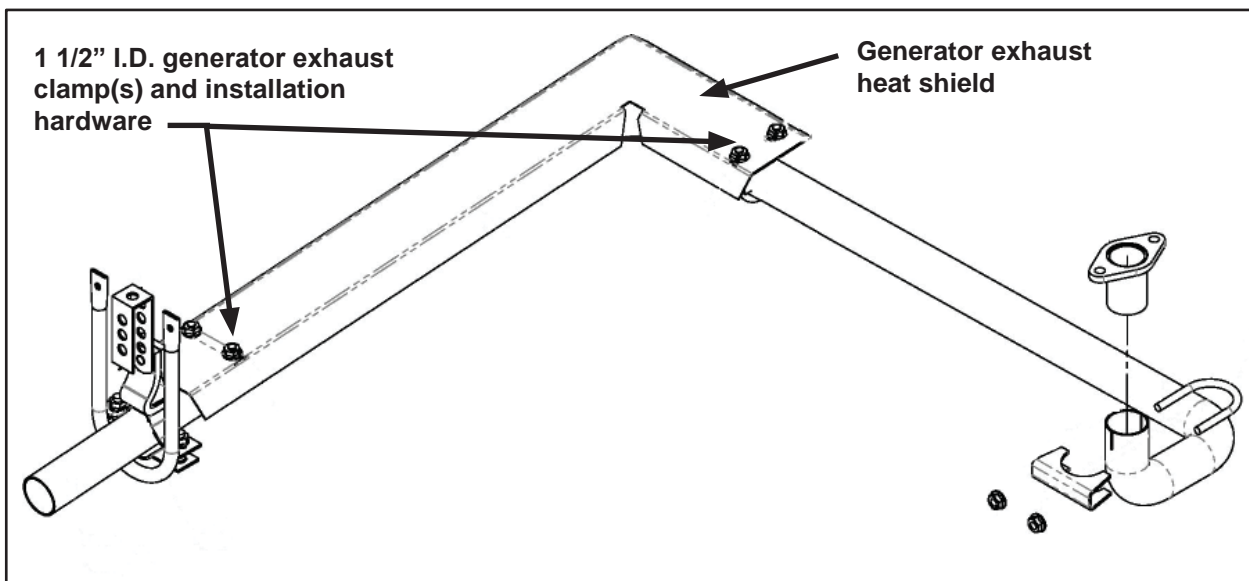

Figure 6

This bulletin is supplied for technical information only and is not an authorization for repairs.

Federal law (section 154 of the national traffic and motor vehicle safety act of 1966) requires that: If you have received a notice of recall or failure to comply from REV Recreation Group or any component Manufacturer, you must repair or otherwise correct the defects on vehicles remaining in your inventory, according to the notification, before selling or leasing the vehicles. Any vehicle lessor receiving this recall notice must forward a copy of the notice to the lessee within ten days.

"It is impossible to know, evaluate and advise the service trade of all conceivable ways in which service might be done or of the possible hazardous consequences of each way. Accordingly, anyone who uses a service procedure or tool must first assure that neither personal safety nor vehicle safety will be jeopardized by the selected service methods."

12. With the heat shield in place, slide the new generator exhaust pipe onto the generator exhaust port until it is fully seated to the bottom of the flared end or is tight against the bottom of the generator. Be sure it is oriented so that it exits the side of the motorhome under the luggage door. Clamp in place with the U-bolt exhaust clamp previously removed; take care to position the U-bolt so that the nuts can be easily tightened with a ratchet and a 1/2" deep well socket. Reference Figures 7 and 8.



Figure 7



Figure 8

13. With the luggage door open, attach the generator exhaust hanger removed in Step 6 to the generator exhaust pipe using the original hardware. Once attached to the generator exhaust pipe, use a 1/4-20 X 1" HWH self-drilling screw to secure the exhaust hanger to the square steel tube located behind the luggage door fascia. Verify the pipe is mounted in a location that will allow the luggage door to close without contacting the exhaust pipe. Refer to Figure 9.

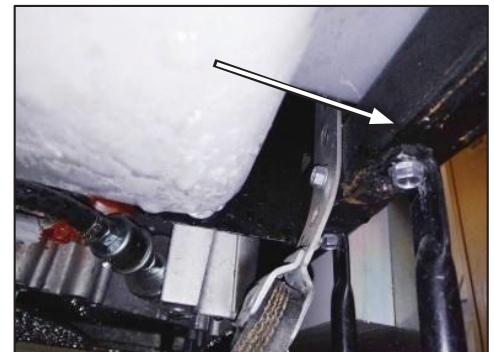

Figure 9

14. Before proceeding, verify that the generator exhaust pipe protrudes past the vertical surface of the luggage door(s) by a minimum of 1". See Figure 10. Adjust as needed to achieve proper spacing.



Figure 10

This bulletin is supplied for technical information only and is not an authorization for repairs.

Federal law (section 154 of the national traffic and motor vehicle safety act of 1966) requires that: If you have received a notice of recall or failure to comply from REV Recreation Group or any component Manufacturer, you must repair or otherwise correct the defects on vehicles remaining in your inventory, according to the notification, before selling or leasing the vehicles. Any vehicle lessor receiving this recall notice must forward a copy of the notice to the lessee within ten days.

"It is impossible to know, evaluate and advise the service trade of all conceivable ways in which service might be done or of the possible hazardous consequences of each way. Accordingly, anyone who uses a service procedure or tool must first assure that neither personal safety nor vehicle safety will be jeopardized by the selected service methods."

15. Once the proper clearances are verified, install the generator exhaust guard that was removed in Step 7 using 1/4-20 X 1" HWH self-drilling screws. It may be required to bend the mounting tabs to 90° as this will be attached to the underside of the steel tube located behind the luggage door fascia as shown in Figure 11.
16. Close and reopen the luggage door to verify that there are no interferences; adjust as needed. If no interferences are identified, the repair is complete.



PHOTO REQUIREMENT: When the repair has been completed, kneel down and take several photos that clearly show that the generator exhaust pipe has been properly routed. Be sure at least one photograph includes the area from the centerline of the rear tire to the rear bumper. Refer to Figure 2, "Acceptable Routing" examples, on Page 3. The photos **must** be attached

to the repair claim.

Repair Steps for Models 35P and 36P only

Ensure all needed parts are on hand before beginning. Refer to Parts List "B" on Page 9.

17. Begin reinstallation by sliding the new generator exhaust pipe onto the generator exhaust port until it is fully seated to the bottom of the flared end or is tight against the bottom of the generator. Be sure it is oriented so that it exits the side of the motorhome, under the luggage door. Clamp in place with the U-bolt exhaust clamp previously removed; take care to position the U-bolt so that the nuts can be easily tightened with a ratchet and a 1/2" deep well socket. Reference Figures 12 and 13.

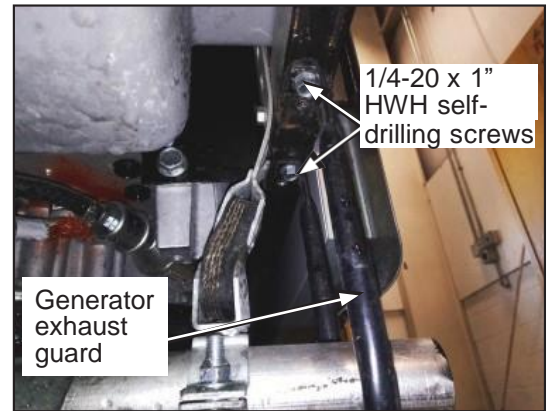

Figure 11



Figure 12– Correct Orientation (viewed facing front of coach)



Figure 10

This bulletin is supplied for technical information only and is not an authorization for repairs.

Federal law (section 154 of the national traffic and motor vehicle safety act of 1966) requires that: If you have received a notice of recall or failure to comply from REV Recreation Group or any component Manufacturer, you must repair or otherwise correct the defects on vehicles remaining in your inventory, according to the notification, before selling or leasing the vehicles. Any vehicle lessor receiving this recall notice must forward a copy of the notice to the lessee within ten days.

"It is impossible to know, evaluate and advise the service trade of all conceivable ways in which service might be done or of the possible hazardous consequences of each way. Accordingly, anyone who uses a service procedure or tool must first assure that neither personal safety nor vehicle safety will be jeopardized by the selected service methods."

18. With the luggage door open, use the generator exhaust hanger removed in Step 6 as a template to locate and drill a 5/16" hole above the generator exhaust pipe in the metal luggage door fascia as shown in Figure 14.
19. Move the generator exhaust hanger behind the metal luggage door fascia and secure it in place with a 1/4 - 20 x 1 bolt and lock nut, using 1/4" flat washers on the inner and outer surfaces of the union.
20. Finish installing the generator exhaust hanger by installing the bottom portion of the hanger around the generator exhaust pipe.
21. Close and reopen the luggage door to verify that there are no interferences; adjust as needed.

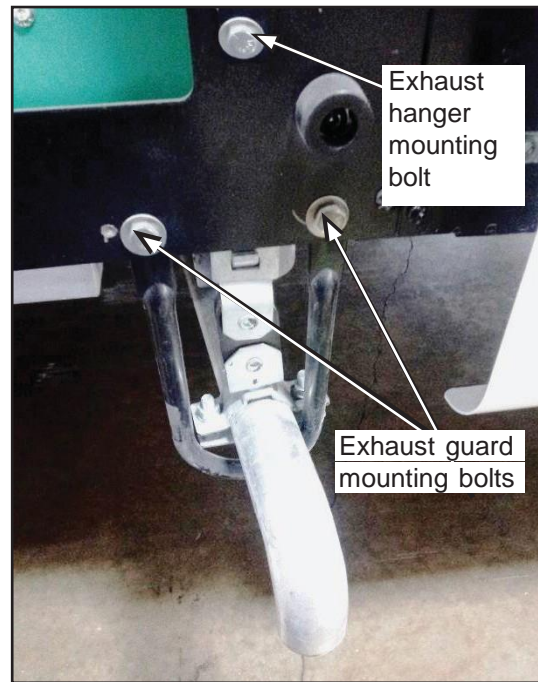

Figure 14

22. With the luggage door open, using the exhaust guard removed in Step 7 as a template, mark and drill (two) 5/16" holes in the metal luggage door fascia. Refer to Figure 14.
23. Move the generator exhaust guard behind the metal luggage door fascia and secure it in place with (2) 1/4 - 20 x 1 bolts and lock nuts, using 1/4" flat washers on the inner and outer surfaces of the unions.
24. Close and reopen the luggage door to verify that there are no interferences, adjust as needed. If no interferences are identified, the repair is complete.



PHOTO REQUIREMENT: When the repair has been completed, kneel down and take several photos that clearly show that the generator exhaust pipe has been properly routed. Be sure at least one photograph includes the area from the centerline of the rear tire to the rear bumper. Refer to Figure 2, "Acceptable Routing" examples, on Page 3. The photos **must** be attached to the repair claim.

This bulletin is supplied for technical information only and is not an authorization for repairs.

Federal law (section 154 of the national traffic and motor vehicle safety act of 1966) requires that: If you have received a notice of recall or failure to comply from REV Recreation Group or any component Manufacturer, you must repair or otherwise correct the defects on vehicles remaining in your inventory, according to the notification, before selling or leasing the vehicles. Any vehicle lessor receiving this recall notice must forward a copy of the notice to the lessee within ten days.

"It is impossible to know, evaluate and advise the service trade of all conceivable ways in which service might be done or of the possible hazardous consequences of each way. Accordingly, anyone who uses a service procedure or tool must first assure that neither personal safety nor vehicle safety will be jeopardized by the selected service methods."

TOOLS

Wheel Chocks	½" Socket
Power Driver	Ratchet
Driver Bits	Flashlight
½" Open End Wrench	

PARTS

Order only the part numbers listed below that pertain to the model of vehicle with which you are working:

Parts List "A" - Applies to All Affected Models Other Than 35P and 36P:

<u>Part Number</u>	<u>Description</u>	<u>Qty.</u>
10787563 (ref. B65-0135)	Generator Exhaust Pipe	1 ea.
10789669 (ref. B85-0646)	Generator Exhaust Heat Shield	1 ea.
10124615 (ref. L50-0998)	Exhaust Clamp	3 ea.
10089470 (ref. M66-1407)	Screw-Tek 1/4-20 X 1 HWH Pltd	3 ea.
<u>Order only if original parts are damaged or missing:</u>		
10006666 (L50-0010)	Exhaust Hanger	1 ea.
10005580 (ref. F76-0373)	Exhaust Guard	1 ea.

Parts List "B" - Applies to Model 35P or 36P only:

<u>Part Number</u>	<u>Description</u>	<u>Qty.</u>
10774830 (ref. B65-0132)	Generator Exhaust Pipe	1 ea.
10007182 (ref. M06-1008)	1/4-20 x 1" Bolts	3 ea.
10007303 (ref. M22-1010)	1/4-20 Lock Nuts	3 ea.
<u>Order only if original parts are damaged or missing:</u>		
10006666 (ref. L50-0010)	Exhaust Hanger	1 ea.
10005580 (ref. F76-0373)	Exhaust Guard	1 ea.

WARRANTY LABOR ALLOWANCE:

Recall 191125REV, Boulder/Southwind/Vacationer Generator Exhaust Routing

Use flat rate codes:

6090-11	Inspected/Not Defective	0.2 hr.	Prior Authorization & Photos Required
6090-12	Inspected/Defective/Repaired	0.6 hr.	Prior Authorization & "Before" and "After" Photos Required

If you have any questions concerning this bulletin, contact REV Dealer Technical Support:

Fleetwood Dealer Technical Support: (800) 816-9825
Holiday Rambler Dealer Technical Support: (877) 332-9239

Service Literature is available at: <http://www.revrdealers.com>

This bulletin is supplied for technical information only and is not an authorization for repairs.

Federal law (section 154 of the national traffic and motor vehicle safety act of 1966) requires that: If you have received a notice of recall or failure to comply from REV Recreation Group or any component Manufacturer, you must repair or otherwise correct the defects on vehicles remaining in your inventory, according to the notification, before selling or leasing the vehicles. Any vehicle lessor receiving this recall notice must forward a copy of the notice to the lessee within ten days.

"It is impossible to know, evaluate and advise the service trade of all conceivable ways in which service might be done or of the possible hazardous consequences of each way. Accordingly, anyone who uses a service procedure or tool must first assure that neither personal safety nor vehicle safety will be jeopardized by the selected service methods."

Recall 191125REV
Affected Fleetwood Bounder Vehicles

Model Year 2016

UIN	CHASSIS VIN #	MODEL	UIN	CHASSIS VIN #	MODEL
739KG4419636	1F66F5DY6F	35 K	739KG4420607	1F66F5DY3F0	35 K
739CG4419737	1F66F5DY2F	33 C	739KG4420609	1F66F5DY5F0	35 K
739TG4419920	1F66F5DY8F	34 T	739CG4420610	1F66F5DY5F0A	33 C
739CG4420236	1F66F5DY2F	33 C	739CG4420612	1F66F5DY9F0A	33 C
739KG4420244	1F66F5DY0F	35 K	739CG4420614	1F66F5DY1F0	33 C
739KG4420336	1F66F5DY8F	35 K	739KG4420615	1F66F5DY8F0A	35 K
739CG4420344	1F66F5DYXF	33 C	739KG4420617	1F66F5DYXF0A	35 K
739KG4420353	1F66F5DY3F	35 K	739CG4420619	1F66F5DY2F0A	33 C
739CG4420424	1F66F5DY7F	33 C	739CG4420620	1F66F5DY9F0A	33 C
739CG4420435	1F66F5DY6F	33 C	739TG4420622	1F66F5DY1F0A	34 T
739KG4420440	1F66F5DY0F	35 K	739CG4420672	1F66F5DY3F0A	33 C
739KG4420448	1F66F5DY1F	35 K	739CG4420673	1F66F5DY4F0A	33 C
739KG4420452	1F66F5DY4F	35 K	739CG4420675	1F66F5DY8F0A	33 C
739EG4420456	1F66F5DY2F	36 E	739CG4420676	1F66F5DY2F0A	33 C
739CG4420480	1F66F5DY1F	33 C	739CG4420677	1F66F5DY0F0A	33 C
739KG4420483	1F66F5DY2F	35 K	739CG4420679	1F66F5DY6F0A	33 C
739CG4420489	1F66F5DY5F	33 C	739CG4420680	1F66F5DY4F0A	33 C
739CG4420495	1F66F5DY3F	33 C	739KG4420681	1F66F5DY9F0	35 K
739KG4420497	1F66F5DY4F	35 K	739KG4420682	1F66F5DY9F0A	35 K
739CG4420502	1F66F5DYXF	33 C	739KG4420686	1F66F5DY4F0A	35 K
739KG4420506	1F66F5DY7F	35 K	739KG4420687	1F66F5DY4F0A	35 K
739KG4420510	1F66F5DY5F	35 K	739KG4420688	1F66F5DY7F0	35 K
739CG4420512	1F66F5DY0F	33 C	739KG4420689	1F66F5DY6F0A	35 K
739KG4420514	1F66F5DY2F	35 K	739KG4420690	1F66F5DY2F0A	35 K
739CG4420515	1F66F5DY7F	33 C	739KG4420691	1F66F5DY2F0A	35 K
739KG4420518	1F66F5DY8F	35 K	739KG4420695	1F66F5DY3F0A	35 K
739CG4420519	1F66F5DY2F	33 C	739KG4420696	1F66F5DY5F0A	35 K
739KG4420522	1F66F5DY7F	35 K	739KG4420697	1F66F5DY1F0A	35 K
739KG4420524	1F66F5DY0F	35 K	739KG4420698	1F66F5DY5F0A	35 K
739KG4420527	1F66F5DY9F	35 K	739KG4420699	1F66F5DY8F0A	35 K
739KG4420529	1F66F5DY8F	35 K	739KG4420700	1F66F5DY3F0A	35 K
739KG4420531	1F66F5DY7F	35 K	739TG4420701	1F66F5DY7F0	34 T
739KG4420532	1F66F5DY5F	35 K	739TG4420702	1F66F5DY7F0A	34 T
739KG4420533	1F66F5DY5F	35 K	739CG4420750	1F66F5DY4F0	33 C
739KG4420534	1F66F5DY5F	35 K	739CG4420751	1F66F5DYXF0A	33 C
739KG4420536	1F66F5DY1F	35 K	739CG4420753	1F66F5DY6F0	33 C
739KG4420537	1F66F5DY7F	35 K	739CG4420755	1F66F5DY9F0A	33 C
739KG4420540	1F66F5DYXF	35 K	739CG4420757	1F66F5DY4F0A	33 C
739KG4420591	1F66F5DY7F	35 K	739CG4420758	1F66F5DYXF0A	33 C
739KG4420593	1F66F5DY6F	35 K	739TG4420759	1F66F5DY0F0	34 T
739CG4420594	1F66F5DY8F	33 C	739TG4420760	1F66F5DY1F0A	34 T
739KG4420596	1F66F5DY2F	35 K	739KG4420762	1F66F5DYXF0	35 K
739CG4420598	1F66F5DY9F	33 C	739KG4420763	1F66F5DY8F0	35 K
739KG4420599	1F66F5DY4F	35 K	739KG4420765	1F66F5DY8F0A	35 K
739KG4420601	1F66F5DY2F	35 K	739KG4420766	1F66F5DY0F0A	35 K
739CG4420602	1F66F5DY3F	33 C	739KG4420768	1F66F5DY6F0A	35 K
739CG4420604	1F66F5DY1F	33 C	739KG4420769	1F66F5DY9F0	35 K
739CG4420606	1F66F5DY2F	33 C	739KG4420770	1F66F5DY1F0	35 K

Recall 191125REV
Affected Fleetwood Bounder Vehicles

Model Year 2016

UIN	CHASSIS VIN #	MODEL	UIN	CHASSIS VIN #	MODEL
739KG4420771	1F66F5DY9F	35 K	739EG4420921	1F66F5DY4F0	36 E
739KG4420773	1F66F5DY9F	35 K	739TG4420923	1F66F5DY8F0	34 T
739KG4420774	1F66F5DY5F	35 K	739CG4421016	1F66F5DY6F0	33 C
739HG4420775	1F66F5DY2F	36 H	739CG4421019	1F66F5DY1F0	33 C
739KG4420818	1F66F5DY9F	35 K	739CG4421020	1F66F5DY7F0	33 C
739KG4420819	1F66F5DY3F	35 K	739TG4421021	1F66F5DY2F0	34 T
739KG4420820	1F66F5DY3F	35 K	739TG4421022	1F66F5DY2F0	34 T
739KG4420821	1F66F5DY4F	35 K	739KG4421023	1F66F5DYXF0	35 K
739KG4420822	1F66F5DY5F	35 K	739KG4421024	1F66F5DY9F0	35 K
739KG4420823	1F66F5DY3F	35 K	739TG4421025	1F66F5DY0F0	34 T
739KG4420825	1F66F5DY5F	35 K	739TG4421028	1F66F5DY5F0	34 T
739KG4420826	1F66F5DY4F	35 K	739KG4421029	1F66F5DYXF0	35 K
739KG4420827	1F66F5DYXF	35 K	739KG4421030	1F66F5DY7F0	35 K
739KG4420828	1F66F5DY6F	35 K	739EG4421031	1F66F5DY1F0	36 E
739KG4420829	1F66F5DY4F	35 K	739KG4421032	1F66F5DY0F0	35 K
739KG4420832	1F66F5DY1F	35 K	739EG4421035	1F66F5DY4F0	36 E
739KG4420833	1F66F5DY5F	35 K	739KG4421036	1F66F5DY4F0	35 K
739KG4420834	1F66F5DY6F	35 K	739KG4421037	1F66F5DY7F0	35 K
739CG4420835	1F66F5DY7F	33 C	739CG4421038	1F66F5DY9F0	33 C
739CG4420837	1F66F5DY9F	33 C	739KG4421039	1F66F5DY9F0	35 K
739CG4420838	1F66F5DY0F	33 C	739KG4421040	1F66F5DY2F0	35 K
739CG4420839	1F66F5DY7F	33 C	739EG4421043	1F66F5DY4F0	36 E
739CG4420840	1F66F5DY3F	33 C	739KG4421044	1F66F5DY3F0	35 K
739CG4420841	1F66F5DY4F	33 C	739KG4421045	1F66F5DY9F0	35 K
739CG4420843	1F66F5DY6F	33 C	739KG4421046	1F66F5DY3F0	35 K
739TG4420844	1F66F5DY0F	34 T	739KG4421047	1F66F5DYXF0	35 K
739TG4420845	1F66F5DY0F	34 T	739EG4421049	1F66F5DY4F0	36 E
739TG4420846	1F66F5DY4F	34 T	739KG4421050	1F66F5DY5F0	35 K
739TG4420847	1F66F5DY2F	34 T	739KG4421052	1F66F5DY8F0	35 K
739KG4420892	1F66F5DY6F	35 K	739KG4421053	1F66F5DY6F0	35 K
739TG4420893	1F66F5DY3F	34 T	739EG4421054	1F66F5DY5F0	36 E
739KG4420894	1F66F5DY1F	35 K	739KG4421056	1F66F5DY4F0	35 K
739KG4420897	1F66F5DY6F	35 K	739KG4421058	1F66F5DY6F0	35 K
739KG4420898	1F66F5DY5F	35 K	739KG4421061	1F66F5DY7F0	35 K
739KG4420900	1F66F5DY7F	35 K	739KG4421062	1F66F5DY8F0	35 K
739TG4420901	1F66F5DY5F	34 T	739KG4421065	1F66F5DY4F0	35 K
739KG4420902	1F66F5DY6F	35 K	739TG4421067	1F66F5DY0F0	34 T
739KG4420905	1F66F5DY8F	35 K	739KG4421068	1F66F5DY7F0	35 K
739TG4420906	1F66F5DY9F	34 T	739KG4421071	1F66F5DY8F0	35 K
739KG4420907	1F66F5DY4F	35 K	739TG4421072	1F66F5DY1F0	34 T
739CG4420910	1F66F5DY9F	33 C	739CG4421074	1F66F5DY9F0	33 C
739EG4420912	1F66F5DY7F	36 E	739CG4421075	1F66F5DY8F0	33 C
739TG4420914	1F66F5DYXF	34 T	739CG4421078	1F66F5DY1F0	33 C
739CG4420915	1F66F5DYXF	33 C	739KG4421079	1F66F5DYXF0	35 K
739KG4420916	1F66F5DY3F	35 K	739TG4421080	1F66F5DY1F0	34 T
739CG4420917	1F66F5DY1F	33 C	739KG4421160	1F66F5DY2F0	35 K
739KG4420918	1F66F5DY1F	35 K	739TG4421162	1F66F5DY0F0	34 T
739KG4420920	1F66F5DY9F	35 K	739KG4421165	1F66F5DY3F0	35 K

Recall 191125REV
Affected Fleetwood Bounder Vehicles

Model Year 2016

UIN	CHASSIS VIN #	MODEL	UIN	CHASSIS VIN #	MODEL
739TG4421166	1F66F5DY6F0	34 T	739CG4421357	1F66F5DY6F0	33 C
739KG4421168	1F66F5DY2F0	35 K	739CG4421359	1F66F5DY2F0	33 C
739KG4421170	1F66F5DY0F0	35 K	739KG4421360	1F66F5DY4F0	35 K
739KG4421173	1F66F5DY7F0	35 K	739KG4421362	1F66F5DY1F0	35 K
739CG4421174	1F66F5DY3F0	33 C	739TG4421363	1F66F5DY6F0	34 T
739TG4421175	1F66F5DY6F0	34 T	739KG4421364	1F66F5DY0F0	35 K
739KG4421176	1F66F5DY3F0	35 K	739KG4421384	1F66F5DY8F0	35 K
739TG4421177	1F66F5DY3F0	34 T	739KG4421385	1F66F5DYXF0	35 K
739TG4421180	1F66F5DY9F0	34 T	739HG4421388	1F66F5DY1F0	36 H
739CG4421181	1F66F5DY3F0	33 C	739KG4421389	1F66F5DY7F0	35 K
739CG4421183	1F66F5DY7F0	33 C	739KG4421390	1F66F5DY1F0	35 K
739CG4421205	1F66F5DY0F0	33 C	739HG4421393	1F66F5DY2F0	36 H
739KG4421207	1F66F5DY9F0	35 K	739KG4421394	1F66F5DY8F0	35 K
739CG4421209	1F66F5DY0F0	33 C	739KG4421395	1F66F5DY6F0	35 K
739KG4421210	1F66F5DY5F0	35 K	739TG4421396	1F66F5DY7F0	34 T
739KG4421212	1F66F5DY3F0	35 K	739HG4421398	1F66F5DY3F0	36 H
739KG4421214	1F66F5DY2F0	35 K	739CG4421400	1F66F5DY5F0	33 C
739HG4421216	1F66F5DY5F0	36 H	739CG4421401	1F66F5DY0F0	33 C
739KG4421218	1F66F5DY1F0	35 K	739TG4421402	1F66F5DY0F0	34 T
739KG4421220	1F66F5DY4F0	35 K	739CG4421403	1F66F5DY2F0	33 C
739KG4421222	1F66F5DY9F0	35 K	739KG4421420	1F66F5DYXF0	35 K
739CG4421223	1F66F5DY5F0	33 C	739KG4421421	1F66F5DY3F0	35 K
739KG4421225	1F66F5DY1F0	35 K	739EG4421424	1F66F5DY1F0	36 E
739KG4421227	1F66F5DY9F0	35 K	739KG4421425	1F66F5DYXF0	35 K
739KG4421229	1F66F5DY6F0	35 K	739KG4421428	1F66F5DY5F0	35 K
739KG4421266	1F66F5DY9F0	35 K	739KG4421429	1F66F5DY9F0	35 K
739KG4421300	1F66F5DY2F0	35 K	739KG4421431	1F66F5DY7F0	35 K
739KG4421301	1F66F5DY3F0	35 K	739CG4421433	1F66F5DYXF0	33 C
739TG4421302	1F66F5DY4F0	34 T	739CG4421435	1F66F5DY8F0	33 C
739KG4421305	1F66F5DY1F0	35 K	739CG4421436	1F66F5DY8F0	33 C
739KG4421306	1F66F5DY0F0	35 K	739HG4421438	1F66F5DY0F0	36 H
739KG4421307	1F66F5DY3F0	35 K	739KG4421488	1F66F5DY2F0	35 K
739EG4421308	1F66F5DY8F0	36 E	739CG4421491	1F66F5DY5F0	33 C
739KG4421311	1F66F5DY7F0	35 K	739KG4421492	1F66F5DY3F0	35 K
739CG4421312	1F66F5DY2F0	33 C	739KG4421494	1F66F5DY1F0	35 K
739TG4421313	1F66F5DY0F0	34 T	739CG4421496	1F66F5DYXF0	33 C
739CG4421315	1F66F5DYXF0	33 C	739TG4421497	1F66F5DYXF0	34 T
739EG4421316	1F66F5DYXF0	36 E	739KG4421498	1F66F5DY8F0	35 K
739CG4421317	1F66F5DY8F0	33 C	739CG4421501	1F66F5DY0F0	33 C
739HG4421318	1F66F5DY3F0	36 H	739KG4421502	1F66F5DY8F0	35 K
739CG4421319	1F66F5DY3F0	33 C	739KG4421504	1F66F5DY6G0	35 K
739TG4421345	1F66F5DY3F0	34 T	739CG4421506	1F66F5DY9F0	33 C
739KG4421346	1F66F5DY7F0	35 K	739KG4421531	1F66F5DY5F0	35 K
739CG4421347	1F66F5DY4F0	33 C	739KG4421533	1F66F5DY4F0	35 K
739KG4421350	1F66F5DY6F0	35 K	739KG4421534	1F66F5DY1F0	35 K
739CG4421352	1F66F5DY5F0	33 C	739TG4421535	1F66F5DYXF0	34 T
739CG4421354	1F66F5DY4F0	33 C	739KG4421538	1F66F5DY5F0	35 K
739KG4421355	1F66F5DY2F0	35 K	739KG4421539	1F66F5DY1F0	35 K

Recall 191125REV
Affected Fleetwood Bounder Vehicles

Model Year 2016

UIN	CHASSIS VIN #	MODEL	UIN	CHASSIS VIN #	MODEL
739CG4421543	1F66F5DY7F0	33 C	739TG4421820	1F66F5DY9G0	34 T
739HG4421544	1F66F5DYXF0	36 H	739KG4421822	1F66F5DY7G0	35 K
739CG4421545	1F66F5DYXF0	33 C	739KG4421824	1F66F5DY7G0	35 K
739CG4421547	1F66F5DY6F0	33 C	739KG4421825	1F66F5DY9G0	35 K
739CG4421548	1F66F5DY7F0	33 C	739CG4421828	1F66F5DYXF0	33 C
739HG4421549	1F66F5DY7F0	36 H	739CG4421830	1F66F5DY6F0	33 C
739KG4421579	1F66F5DY0F0	35 K	739KG4421832	1F66F5DY6G0	35 K
739KG4421582	1F66F5DYXF0	35 K	739KG4421855	1F66F5DY4G0	35 K
739HG4421585	1F66F5DY4F0	36 H	739CG4421859	1F66F5DY9F0	33 C
739KG4421589	1F66F5DY0F0	35 K	739KG4421861	1F66F5DY9G0	35 K
739CG4421593	1F66F5DY3F0	33 C	739KG4421863	1F66F5DY8G0	35 K
739KG4421596	1F66F5DY2F0	35 K	739HG4421867	1F66F5DY9G0	36 H
739CG4421599	1F66F5DY4F0	33 C	739KG4421869	1F66F5DY6G0	35 K
739HG4421602	1F66F5DY5F0	36 H	739KG4421870	1F66F5DY3G0	35 K
739KG4421636	1F66F5DY9F0	35 K	739TG4421873	1F66F5DY2G0	34 T
739TG4421640	1F66F5DY8F0	34 T	739KG4421874	1F66F5DY0G0	35 K
739CG4421644	1F66F5DY7F0	33 C	739CG4421876	1F66F5DY0F0	33 C
739HG4421649	1F66F5DY5F0	36 H	739HG4421878	1F66F5DY7G0	36 H
739KG4421682	1F66F5DY0F0	35 K	739KG4421907	1F66F5DY5G0	35 K
739KG4421683	1F66F5DY8F0	35 K	739KG4421909	1F66F5DY4G0	35 K
739KG4421684	1F66F5DY3F0	35 K	739KG4421915	1F66F5DY2G0	35 K
739CG4421712	1F66F5DY1F0	33 C	739KG4421916	1F66F5DY4G0	35 K
739CG4421714	1F66F5DY9F0	33 C	739KG4421919	1F66F5DY1G0	35 K
739TG4421717	1F66F5DY2F0	34 T	739KG4421922	1F66F5DY5G0	35 K
739KG4421718	1F66F5DY1F0	35 K	739KG4421925	1F66F5DY5G0	35 K
739KG4421720	1F66F5DY1F0	35 K	739CG4421928	1F66F5DY1F0	33 C
739TG4421723	1F66F5DY5F0	34 T	739KG4421929	1F66F5DY8G0	35 K
739KG4421724	1F66F5DY7F0	35 K	739CG4421930	1F66F5DY4F0	33 C
739KG4421726	1F66F5DY4F0	35 K	739KG4421960	1F66F5DY0G0	35 K
739HG4421729	1F66F5DY9F0	36 H	739EG4421961	1F66F5DY0G0	36 E
739KG4421730	1F66F5DY0F0	35 K	739TG4421963	1F66F5DY1G0	34 T
739KG4421733	1F66F5DYXF0	35 K	739EG4421966	1F66F5DY0G0	36 E
739HG4421734	1F66F5DY9F0	36 H	739KG4421967	1F66F5DY3G0	35 K
739KG4421780	1F66F5DY6F0	35 K	739TG4421969	1F66F5DYXG0	34 T
739KG4421784	1F66F5DY5F0	35 K	739EG4421972	1F66F5DY6G0	36 E
739TG4421785	1F66F5DY4F0	34 T	739KG4421973	1F66F5DY7G0	35 K
739KG4421786	1F66F5DY3F0	35 K	739HG4421975	1F66F5DY1G0	36 H
739KG4421789	1F66F5DY8G0	35 K	739CG4421976	1F66F5DY3F0	33 C
739KG4421792	1F66F5DY2G0	35 K	739EG4421977	1F66F5DY1G0	36 E
739CG4421794	1F66F5DY1F0	33 C	739CG4421978	1F66F5DY7F0	33 C
739CG4421796	1F66F5DY3F0	33 C	739EG4421980	1F66F5DYXG0	36 E
739KG4421799	1F66F5DY0G0	35 K	739TG4421982	1F66F5DY7G0	34 T
739TG4421800	1F66F5DY9G0	34 T	739CG4422011	1F66F5DY9F0	33 C
739HG4421801	1F66F5DY9G0	36 H	739HG4422013	1F66F5DY1G0	36 H
739HG4421802	1F66F5DY5G0	36 H	739KG4422014	1F66F5DY2G0	35 K
739KG4421816	1F66F5DYXG0	35 K	739KG4422020	1F66F5DY5G0	35 K
739KG4421818	1F66F5DYXG0	35 K	739HG4422021	1F66F5DY0G0	36 H
739KG4421819	1F66F5DY6G0	35 K	739KG4422022	1F66F5DY2G0	35 K

Recall 191125REV
Affected Fleetwood Bounder Vehicles

Model Year 2016

UIN	CHASSIS VIN #	MODEL	UIN	CHASSIS VIN #	MODEL
739KG4422025	1F66F5DY6G0	35 K	739KG4422253	1F66F5DY2G0	35 K
739CG4422027	1F66F5DY2G0	33 C	739KG4422254	1F66F5DY4G0	35 K
739HG4422028	1F66F5DY5G0	36 H	739KG4422258	1F66F5DY7G0	35 K
739KG4422032	1F66F5DY1G0	35 K	739KG4422260	1F66F5DYXG0	35 K
739KG4422033	1F66F5DY8G0	35 K	739KG4422261	1F66F5DY0G0	35 K
739TG4422035	1F66F5DY0G0	34 T	739KG4422265	1F66F5DY4G0	35 K
739CG4422061	1F66F5DY9G0	33 C	739KG4422266	1F66F5DY9G0	35 K
739CG4422062	1F66F5DY4G0	33 C	739KG4422268	1F66F5DY8G0	35 K
739KG4422065	1F66F5DYXG0	35 K	739KG4422269	1F66F5DY7G0	35 K
739KG4422067	1F66F5DY0G0	35 K	739KG4422270	1F66F5DY5G0	35 K
739KG4422068	1F66F5DY9G0	35 K	739CG4422276	1F66F5DY6G0	33 C
739KG4422071	1F66F5DYXG0	35 K	739CG4422277	1F66F5DY6G0	33 C
739KG4422073	1F66F5DY1G0	35 K	739CG4422278	1F66F5DY1G0	33 C
739HG4422074	1F66F5DY9G0	36 H	739CG4422280	1F66F5DYXG0	33 C
739KG4422076	1F66F5DY7G0	35 K	739CG4422281	1F66F5DY1G0	33 C
739HG4422079	1F66F5DY4G0	36 H	739EG4422310	1F66F5DY1G0	36 E
739TG4422080	1F66F5DY5G0	34 T	739KG4422311	1F66F5DY0G0	35 K
739HG4422086	1F66F5DYXG0	36 H	739KG4422315	1F66F5DY7G0	35 K
739KG4422115	1F66F5DY2G0	35 K	739TG4422316	1F66F5DY4G0	34 T
739HG4422118	1F66F5DY3G0	36 H	739KG4422318	1F66F5DY4G0	35 K
739KG4422121	1F66F5DY6G0	35 K	739KG4422319	1F66F5DY8G0	35 K
739HG4422125	1F66F5DY3G0	36 H	739KG4422322	1F66F5DY4G0	35 K
739KG4422126	1F66F5DY7G0	35 K	739HG4422323	1F66F5DY8G0	36 H
739KG4422128	1F66F5DY9G0	35 K	739KG4422326	1F66F5DY6G0	35 K
739KG4422132	1F66F5DY9G0	35 K	739KG4422327	1F66F5DY1G0	35 K
739KG4422134	1F66F5DY4G0	35 K	739CG4422329	1F66F5DY8G0	33 C
739HG4422137	1F66F5DY6G0	36 H	739CG4422330	1F66F5DYXG0	33 C
739KG4422139	1F66F5DY9G0	35 K	739HG4422331	1F66F5DY0G0	36 H
739KG4422169	1F66F5DY6G0	35 K	739CG4422335	1F66F5DYXG0	33 C
739KG4422173	1F66F5DY0G0	35 K	739TG4422336	1F66F5DY2G0	34 T
739EG4422174	1F66F5DY1G0	36 E	739CG4422337	1F66F5DY8G0	33 C
739KG4422176	1F66F5DY3G0	35 K	739KG4422370	1F66F5DY8G0	35 K
739KG4422177	1F66F5DYXG0	35 K	739KG4422371	1F66F5DY1G0	35 K
739KG4422180	1F66F5DYXG0	35 K	739KG4422374	1F66F5DY2G0	35 K
739HG4422182	1F66F5DY7G0	36 H	739HG4422376	1F66F5DYXG0	36 H
739KG4422197	1F66F5DY8G0	35 K	739KG4422379	1F66F5DY6G0	35 K
739KG4422202	1F66F5DY2G0	35 K	739KG4422381	1F66F5DY6G0	35 K
739HG4422203	1F66F5DY8G0	36 H	739KG4422382	1F66F5DY8G0	35 K
739KG4422204	1F66F5DY8G0	35 K	739KG4422384	1F66F5DYXG0	35 K
739KG4422205	1F66F5DY4G0	35 K	739CG4422386	1F66F5DY6G0	33 C
739KG4422208	1F66F5DY9G0	35 K	739KG4422387	1F66F5DY0G0	35 K
739KG4422209	1F66F5DY3G0	35 K	739CG4422390	1F66F5DYXG0	33 C
739KG4422212	1F66F5DY1G0	35 K	739TG4422392	1F66F5DY4G0	34 T
739CG4422215	1F66F5DY0G0	33 C	739HG4422416	1F66F5DY9G0	36 H
739CG4422216	1F66F5DY6G0	33 C	739KG4422417	1F66F5DY0G0	35 K
739CG4422219	1F66F5DY9G0	33 C	739KG4422420	1F66F5DYXG0	35 K
739TG4422222	1F66F5DY3G0	34 T	739KG4422422	1F66F5DY6G0	35 K
739KG4422223	1F66F5DY1G0	35 K	739KG4422425	1F66F5DY4G0	35 K

Recall 191125REV
Affected Fleetwood Bounder Vehicles

Model Year 2016

UIN	CHASSIS VIN #	MODEL	UIN	CHASSIS VIN #	MODEL
739KG4422428	1F66F5DY3G	35 K	739KG4422629	1F66F5DYXG0	35 K
739HG4422429	1F66F5DY0G	36 H	739HG4422633	1F66F5DY8G0	36 H
739KG4422430	1F66F5DY9G	35 K	739CG4422634	1F66F5DY4G0	33 C
739KG4422433	1F66F5DY7G	35 K	739KG4422637	1F66F5DY7G0	35 K
739KG4422436	1F66F5DY3G	35 K	739TG4422640	1F66F5DY2G0	34 T
739KG4422438	1F66F5DY5G	35 K	739CG4422642	1F66F5DY0G0	33 C
739KG4422440	1F66F5DYXG	35 K	739TG4422643	1F66F5DY7G0	34 T
739KG4422441	1F66F5DY7G	35 K	739HG4422645	1F66F5DY8G0	36 H
739KG4422444	1F66F5DY5G	35 K	739KG4422681	1F66F5DY0G0	35 K
739HG4422445	1F66F5DY0G	36 H	739KG4422682	1F66F5DY1G0	35 K
739KG4422446	1F66F5DY8G	35 K	739CG4422684	1F66F5DY3G0	33 C
739EG4422480	1F66F5DY9G	36 E	739KG4422685	1F66F5DY2G0	35 K
739HG4422481	1F66F5DY9G	36 H	739KG4422688	1F66F5DY9G0	35 K
739KG4422484	1F66F5DY2G	35 K	739KG4422689	1F66F5DY3G0	35 K
739KG4422485	1F66F5DY1G	35 K	739EG4422691	1F66F5DY4G0	36 E
739KG4422488	1F66F5DY8G	35 K	739KG4422693	1F66F5DY6G0	35 K
739KG4422489	1F66F5DY3G	35 K	739HG4422694	1F66F5DYXG0	36 H
739KG4422491	1F66F5DYXG	35 K	739KG4422696	1F66F5DY0G0	35 K
739TG4422492	1F66F5DY4G	34 T	739KG4422698	1F66F5DY3G0	35 K
739KG4422493	1F66F5DY9G	35 K	739KG4422700	1F66F5DYXG0	35 K
739KG4422496	1F66F5DY1G	35 K	739CG4422702	1F66F5DY6G0	33 C
739KG4422497	1F66F5DY7G	35 K	739CG4422704	1F66F5DY0G0	33 C
739KG4422499	1F66F5DY6G	35 K	739CG4422706	1F66F5DY8G0	33 C
739KG4422501	1F66F5DY4G	35 K	739CG4422708	1F66F5DY8G0	33 C
739CG4422504	1F66F5DY4G	33 C	739TG4422710	1F66F5DY1G0	34 T
739CG4422507	1F66F5DY3G	33 C	739KG4422761	1F66F5DY1G0	35 K
739CG4422509	1F66F5DY7G	33 C	739KG4422762	1F66F5DY3G0	35 K
739KG4422544	1F66F5DY5G	35 K	739KG4422765	1F66F5DYXG0	35 K
739KG4422546	1F66F5DY6G	35 K	739KG4422769	1F66F5DY4G0	35 K
739KG4422548	1F66F5DY7G	35 K	739KG4422772	1F66F5DY8G0	35 K
739KG4422550	1F66F5DY5G	35 K	739KG4422773	1F66F5DY2G0	35 K
739KG4422552	1F66F5DYXG	35 K	739KG4422775	1F66F5DY1G0	35 K
739TG4422553	1F66F5DY9G	34 T	739TG4422776	1F66F5DY4G0	34 T
739KG4422554	1F66F5DY2G	35 K	739KG4422777	1F66F5DY2G0	35 K
739KG4422555	1F66F5DY2G	35 K	739HG4422779	1F66F5DY9G0	36 H
739KG4422557	1F66F5DY0G	35 K	739KG4422780	1F66F5DY5G0	35 K
739KG4422559	1F66F5DY4G	35 K	739CG4422783	1F66F5DY2G0	33 C
739EG4422561	1F66F5DY0G	36 E	739EG4422785	1F66F5DY6G0	36 E
739KG4422563	1F66F5DY9G	35 K	739CG4422787	1F66F5DY4G0	33 C
739CG4422564	1F66F5DY1G	33 C	739HG4422788	1F66F5DY6G0	36 H
739CG4422566	1F66F5DY9G	33 C	739CG4422789	1F66F5DY8G0	33 C
739CG4422568	1F66F5DY8G	33 C	739CG4422791	1F66F5DY6G0	33 C
739KG4422570	1F66F5DY8G	35 K	739CG4422792	1F66F5DY1G0	33 C
739CG4422572	1F66F5DYXG	33 C	739CG4422794	1F66F5DY7G0	33 C
739KG4422573	1F66F5DY9G	35 K	739CG4422796	1F66F5DY3G0	33 C
739EG4422623	1F66F5DY8G	36 E	739KG4422820	1F66F5DY9G0	35 K
739KG4422624	1F66F5DY0G	35 K	739KG4422821	1F66F5DY3G0	35 K
739KG4422627	1F66F5DY5G	35 K	739TG4422828	1F66F5DY7G0	34 T

Recall 191125REV
Affected Fleetwood Bounder Vehicles

Model Year 2016

UIN	CHASSIS VIN #	MODEL	UIN	CHASSIS VIN #	MODEL
739KG4422829	1F66F5DY4G	35 K	739KG4423039	1F66F5DY3G	35 K
739HG4422832	1F66F5DY8G	36 H	739KG4423040	1F66F5DY4G	35 K
739KG4422834	1F66F5DY0G	35 K	739KG4423041	1F66F5DY5G	35 K
739KG4422836	1F66F5DY8G	35 K	739KG4423043	1F66F5DY8G	35 K
739TG4422838	1F66F5DY9G	34 T	739KG4423045	1F66F5DY5G	35 K
739KG4422840	1F66F5DY9G	35 K	739KG4423046	1F66F5DY1G	35 K
739CG4422842	1F66F5DY9G	33 C	739HG4423047	1F66F5DYXG	36 H
739CG4422843	1F66F5DY0G	33 C	739KG4423048	1F66F5DY0G	35 K
739TG4422844	1F66F5DY8G	34 T	739KG4423050	1F66F5DY5G	35 K
739HG4422846	1F66F5DY2G	36 H	739HG4423051	1F66F5DY9G	36 H
739CG4422848	1F66F5DYXG	33 C	739KG4423054	1F66F5DY0G	35 K
739KG4422851	1F66F5DY0G	35 K	739HG4423055	1F66F5DY5G	36 H
739KG4422853	1F66F5DY4G	35 K	739KG4423085	1F66F5DY4G	35 K
739KG4422856	1F66F5DY5G	35 K	739KG4423086	1F66F5DY9G	35 K
739KG4422890	1F66F5DY5G	35 K	739KG4423088	1F66F5DY7G	35 K
739KG4422891	1F66F5DYXG	35 K	739TG4423089	1F66F5DYXG	34 T
739TG4422892	1F66F5DY7G	34 T	739KG4423091	1F66F5DY9G	35 K
739KG4422894	1F66F5DY0G	35 K	739KG4423092	1F66F5DY7G	35 K
739KG4422895	1F66F5DY3G	35 K	739KG4423095	1F66F5DY8G	35 K
739KG4422898	1F66F5DY0G	35 K	739TG4423096	1F66F5DY1G	34 T
739KG4422899	1F66F5DY8G	35 K	739KG4423098	1F66F5DY4G	35 K
739KG4422900	1F66F5DY6G	35 K	739KG4423099	1F66F5DY1G	35 K
739KG4422902	1F66F5DY5G	35 K	739KG4423101	1F66F5DY3G	35 K
739CG4422903	1F66F5DY5G	33 C	739HG4423102	1F66F5DY1G	36 H
739CG4422906	1F66F5DY1G	33 C	739CG4423103	1F66F5DY0G	33 C
739HG4422908	1F66F5DY0G	36 H	739CG4423105	1F66F5DY3G	33 C
739TG4422921	1F66F5DY2G	34 T	739CG4423106	1F66F5DY3G	33 C
739KG4422988	1F66F5DYXG	35 K	739EG4423107	1F66F5DY8G	36 E
739KG4422989	1F66F5DY2G	35 K	739KG4423153	1F66F5DY5G	35 K
739KG4422991	1F66F5DY9G	35 K	739KG4423154	1F66F5DY4G	35 K
739KG4422992	1F66F5DY6G	35 K	739HG4423157	1F66F5DY3G	36 H
739KG4422998	1F66F5DY0G	35 K	739HG4423159	1F66F5DYXG	36 H
739KG4423000	1F66F5DY7G	35 K	739KG4423161	1F66F5DY2G	35 K
739KG4423001	1F66F5DY7G	35 K	739KG4423164	1F66F5DY1G	35 K
739HG4423004	1F66F5DYXG	36 H	739CG4423166	1F66F5DY5G	33 C
739CG4423006	1F66F5DYXG	33 C	739HG4423167	1F66F5DY4G	36 H
739HG4423011	1F66F5DY7G	36 H	739TG4423170	1F66F5DYXG	34 T
739CG4423014	1F66F5DY6G	33 C	739CG4423173	1F66F5DY5G	33 C
739TG4423019	1F66F5DY2G	34 T	739HG4423174	1F66F5DY4G	36 H
739CG4423032	1F66F5DY6G	33 C	739CG4423176	1F66F5DY3G	33 C
739CG4423034	1F66F5DY6G	33 C	739TG4423177	1F66F5DY9G	34 T
739CG4423035	1F66F5DY8G	33 C	739KG4423180	1F66F5DY8G	35 K
739TG4423037	1F66F5DYXG	34 T			

Recall 191125REV
Affected Fleetwood Bounder Vehicles

Model Year 2017

UIN	CHASSIS VIN #	MODEL	UIN	CHASSIS VIN #	MODEL
739YH4422728	1F66F5DY5	36 Y	739YH4423384	1F66F5DY4G	36 Y
739KH4423255	1F66F5DY2	35 K	739KH4423386	1F66F5DY7G	35 K
739KH4423257	1F66F5DY8	35 K	739KH4423389	1F66F5DY9G	35 K
739HH4423258	1F66F5DY5	36 H	739HH4423390	1F66F5DY0G	36 H
739KH4423261	1F66F5DYX	35 K	739XH4423393	1F66F5DY1G	36 X
739TH4423262	1F66F5DY7	34 T	739HH4423394	1F66F5DY6G	36 H
739KH4423263	1F66F5DY9	35 K	739KH4423428	1F66F5DY1G	35 K
739XH4423264	1F66F5DY2	36 X	739KH4423430	1F66F5DY0G	35 K
739KH4423266	1F66F5DY8	35 K	739XH4423431	1F66F5DY2G	36 X
739KH4423270	1F66F5DY9	35 K	739KH4423432	1F66F5DYXG	35 K
739CH4423272	1F66F5DY5	33 C	739HH4423433	1F66F5DY6G	36 H
739HH4423277	1F66F5DYX	36 H	739KH4423435	1F66F5DY1G	35 K
739YH4423282	1F66F5DY7	36 Y	739XH4423436	1F66F5DY5G	36 X
739KH4423283	1F66F5DY6	35 K	739KH4423439	1F66F5DY1G	35 K
739KH4423286	1F66F5DY9	35 K	739XH4423440	1F66F5DY9G	36 X
739XH4423302	1F66F5DY6	36 X	739KH4423441	1F66F5DYXG	35 K
739KH4423303	1F66F5DY4	35 K	739KH4423445	1F66F5DY7G	35 K
739KH4423306	1F66F5DY3	35 K	739HH4423446	1F66F5DY4G	36 H
739KH4423308	1F66F5DY4	35 K	739KH4423448	1F66F5DY2G	35 K
739HH4423310	1F66F5DY5	36 H	739KH4423451	1F66F5DY5G	35 K
739KH4423311	1F66F5DY1	35 K	739KH4423453	1F66F5DY8G	35 K
739KH4423315	1F66F5DY1	35 K	739YH4423455	1F66F5DYXG	36 Y
739XH4423317	1F66F5DY6	36 X	739KH4423457	1F66F5DYXG	35 K
739KH4423318	1F66F5DY3	35 K	739YH4423458	1F66F5DY4G	36 Y
739HH4423320	1F66F5DY4	36 H	739CH4423459	1F66F5DY3G	33 C
739KH4423321	1F66F5DYX	35 K	739YH4423460	1F66F5DY9G	36 Y
739KH4423323	1F66F5DY6	35 K	739CH4423505	1F66F5DY7G	33 C
739KH4423325	1F66F5DY5	35 K	739XH4423506	1F66F5DY0G	36 X
739YH4423326	1F66F5DY3	36 Y	739KH4423507	1F66F5DY8G	35 K
739KH4423328	1F66F5DY1	35 K	739KH4423510	1F66F5DYXG	35 K
739HH4423329	1F66F5DY8	36 H	739HH4423511	1F66F5DYXG	36 H
739KH4423331	1F66F5DY6	35 K	739YH4423514	1F66F5DY8G	36 Y
739CH4423333	1F66F5DY7	33 C	739KH4423516	1F66F5DY3G	35 K
739HH4423334	1F66F5DY2	36 H	739HH4423517	1F66F5DY8G	36 H
739KH4423335	1F66F5DY2	35 K	739KH4423521	1F66F5DY7G	35 K
739HH4423338	1F66F5DY0	36 H	739KH4423522	1F66F5DY5G	35 K
739KH4423339	1F66F5DY4	35 K	739TH4423523	1F66F5DY6G	34 T
739HH4423364	1F66F5DY1	36 H	739KH4423524	1F66F5DY5G	35 K
739KH4423366	1F66F5DY7	35 K	739YH4423525	1F66F5DY2G	36 Y
739HH4423367	1F66F5DYX	36 H	739KH4423527	1F66F5DY6G	35 K
739KH4423368	1F66F5DY7	35 K	739YH4423528	1F66F5DY7G	36 Y
739KH4423371	1F66F5DY6	35 K	739CH4423529	1F66F5DYXG	33 C
739KH4423372	1F66F5DY4	35 K	739YH4423531	1F66F5DY2G	36 Y
739XH4423375	1F66F5DY0	36 X	739CH4423532	1F66F5DY3G	33 C
739KH4423376	1F66F5DYX	35 K	739YH4423536	1F66F5DY1G	36 Y
739HH4423379	1F66F5DY2	36 H	739KH4423539	1F66F5DY6G	35 K
739YH4423381	1F66F5DY5	36 Y	739KH4423564	1F66F5DY8G	35 K
739CH4423383	1F66F5DY5	33 C	739KH4423565	1F66F5DY3G	35 K

Recall 191125REV
Affected Fleetwood Bounder Vehicles

Model Year 2017

UIN	CHASSIS VIN #	MODEL	UIN	CHASSIS VIN #	MODEL
739YH4423566	1F66F5DY2G	36 Y	739HH4423750	1F66F5DYXG0	36 H
739KH4423567	1F66F5DY8G	35 K	739XH4423752	1F66F5DY1G0	36 X
739KH4423572	1F66F5DY2G	35 K	739KH4423753	1F66F5DY6G0	35 K
739KH4423573	1F66F5DY6G	35 K	739YH4423754	1F66F5DY7G0	36 Y
739YH4423574	1F66F5DYXG	36 Y	739KH4423755	1F66F5DY3G0	35 K
739KH4423576	1F66F5DY2G	35 K	739KH4423757	1F66F5DY2G0	35 K
739KH4423578	1F66F5DY2G	35 K	739HH4423758	1F66F5DY8G0	36 H
739HH4423579	1F66F5DY6G	36 H	739KH4423763	1F66F5DY5G0	35 K
739YH4423582	1F66F5DY7G	36 Y	739YH4423764	1F66F5DY5G0	36 Y
739KH4423583	1F66F5DY2G	35 K	739KH4423767	1F66F5DY0G0	35 K
739YH4423584	1F66F5DY4G	36 Y	739HH4423768	1F66F5DY9G0	36 H
739KH4423587	1F66F5DY3G	35 K	739KH4423769	1F66F5DY7G0	35 K
739YH4423588	1F66F5DY5G	36 Y	739CH4423772	1F66F5DY5G0	33 C
739KH4423590	1F66F5DY7G	35 K	739YH4423773	1F66F5DY8G0	36 Y
739HH4423592	1F66F5DY3G	36 H	739CH4423777	1F66F5DY5G0	33 C
739CH4423594	1F66F5DY9G	33 C	739XH4423781	1F66F5DY1G0	36 X
739CH4423595	1F66F5DY0G	33 C	739KH4423784	1F66F5DY3G0	35 K
739XH4423597	1F66F5DY9G	36 X	739HH4423786	1F66F5DY5G0	36 H
739XH4423598	1F66F5DY3G	36 X	739KH4423789	1F66F5DYXG0	35 K
739KH4423658	1F66F5DY8G	35 K	739KH4423790	1F66F5DY3G0	35 K
739HH4423659	1F66F5DY1G	36 H	739KH4423793	1F66F5DY2G0	35 K
739XH4423662	1F66F5DYXG	36 X	739KH4423794	1F66F5DY4G0	35 K
739KH4423663	1F66F5DY0G	35 K	739XH4423795	1F66F5DY1G0	36 X
739KH4423665	1F66F5DY8G	35 K	739KH4423797	1F66F5DY4G0	35 K
739KH4423666	1F66F5DY5G	35 K	739KH4423798	1F66F5DYXG0	35 K
739KH4423667	1F66F5DY9G	35 K	739KH4423799	1F66F5DY5G0	35 K
739KH4423670	1F66F5DY4G	35 K	739YH4423800	1F66F5DYXG0	36 Y
739HH4423672	1F66F5DYXG	36 H	739KH4423802	1F66F5DY1G0	35 K
739KH4423674	1F66F5DY8G	35 K	739YH4423803	1F66F5DY2G0	36 Y
739KH4423675	1F66F5DY4G	35 K	739CH4423804	1F66F5DY0G0	33 C
739YH4423676	1F66F5DY8G	36 Y	739KH4423805	1F66F5DY9G0	35 K
739KH4423678	1F66F5DYXG	35 K	739KH4423807	1F66F5DY0G0	35 K
739KH4423679	1F66F5DY2G	35 K	739YH4423808	1F66F5DY7G0	36 Y
739YH4423680	1F66F5DY4G	36 Y	739KH4423869	1F66F5DY7G0	35 K
739KH4423681	1F66F5DY6G	35 K	739YH4423871	1F66F5DY7G0	36 Y
739KH4423683	1F66F5DY1G	35 K	739KH4423875	1F66F5DY9G0	35 K
739KH4423685	1F66F5DY4G	35 K	739CH4423876	1F66F5DY8G0	33 C
739KH4423686	1F66F5DY2G	35 K	739KH4423880	1F66F5DY8G0	35 K
739YH4423687	1F66F5DY0G	36 Y	739CH4423881	1F66F5DY7G0	33 C
739CH4423689	1F66F5DY9G	33 C	739KH4423884	1F66F5DY3G0	35 K
739HH4423692	1F66F5DY8G	36 H	739CH4423888	1F66F5DY0G0	33 C
739CH4423693	1F66F5DY2G	33 C	739KH4423891	1F66F5DY5G0	35 K
739XH4423694	1F66F5DY3G	36 X	739CH4423893	1F66F5DY3G0	33 C
739KH4423695	1F66F5DY6G	35 K	739CH4423894	1F66F5DY2G0	33 C
739KH4423697	1F66F5DY9G	35 K	739CH4423897	1F66F5DY1G0	33 C
739KH4423746	1F66F5DY2G	35 K	739CH4423943	1F66F5DY7G0	33 C
739KH4423748	1F66F5DY6G	35 K	739CH4423944	1F66F5DY1G0	33 C
739KH4423749	1F66F5DY4G	35 K	739KH4423945	1F66F5DY6G0	35 K

Recall 191125REV
Affected Fleetwood Bounder Vehicles

Model Year 2017

UIN	CHASSIS VIN #	MODEL	UIN	CHASSIS VIN #	MODEL
739XH4423947	1F66F5DY0G	36 X	739KH4424090	1F66F5DY5G	35 K
739CH4423949	1F66F5DY8G	33 C	739KH4424093	1F66F5DYXG	35 K
739CH4423950	1F66F5DY3G	33 C	739KH4424094	1F66F5DY0G	35 K
739KH4423953	1F66F5DY7G	35 K	739HH4424096	1F66F5DY4G	36 H
739KH4423957	1F66F5DY4G	35 K	739KH4424098	1F66F5DY2H	35 K
739XH4423960	1F66F5DY3G	36 X	739KH4424100	1F66F5DY1H	35 K
739KH4423961	1F66F5DY5G	35 K	739KH4424102	1F66F5DY4H	35 K
739YH4423963	1F66F5DY2G	36 Y	739YH4424104	1F66F5DYXG	36 Y
739KH4423968	1F66F5DY9G	35 K	739HH4424105	1F66F5DY2G	36 H
739KH4423969	1F66F5DY5G	35 K	739CH4424120	1F66F5DY1H	33 C
739CH4423971	1F66F5DYXH	33 C	739CH4424122	1F66F5DY6H	33 C
739KH4423972	1F66F5DY8G	35 K	739CH4424125	1F66F5DY4H	33 C
739CH4423973	1F66F5DY0H	33 C	739CH4424128	1F66F5DY2H	33 C
739KH4423975	1F66F5DY1G	35 K	739YH4424131	1F66F5DY0G	36 Y
739CH4424011	1F66F5DY7H	33 C	739CH4424179	1F66F5DY7H	33 C
739YH4424017	1F66F5DY2G	36 Y	739CH4424183	1F66F5DY3H	33 C
739KH4424018	1F66F5DYXG	35 K	739CH4424186	1F66F5DY7H	33 C
739KH4424019	1F66F5DY0G	35 K	739CH4424189	1F66F5DY9H	33 C
739KH4424020	1F66F5DY4G	35 K	739CH4424192	1F66F5DY5H	33 C
739KH4424022	1F66F5DY3G	35 K	739CH4424194	1F66F5DY0H	33 C
739HH4424023	1F66F5DY5G	36 H	739KH4424199	1F66F5DY1H	35 K
739KH4424024	1F66F5DY0G	35 K	739CH4424203	1F66F5DY6H	33 C
739YH4424026	1F66F5DY9G	36 Y	739KH4424208	1F66F5DY2H	35 K
739KH4424027	1F66F5DY3G	35 K	739CH4424219	1F66F5DYXH	33 C
739KH4424029	1F66F5DY8G	35 K	739HH4424222	1F66F5DY2H	36 H
739YH4424030	1F66F5DY8G	36 Y	739CH4424224	1F66F5DY2H	33 C
739KH4424031	1F66F5DY4G	35 K	739CH4424228	1F66F5DY6H	33 C
739HH4424032	1F66F5DY1G	36 H	739YH4424231	1F66F5DY0G	36 Y
739KH4424033	1F66F5DY2G	35 K	739CH4424232	1F66F5DY1H	33 C
739HH4424034	1F66F5DY7G	36 H	739CH4424233	1F66F5DY9H	33 C
739KH4424035	1F66F5DY1G	35 K	739KH4424236	1F66F5DY5H	35 K
739HH4424036	1F66F5DY3G	36 H	739HH4424237	1F66F5DY2H	36 H
739TH4424037	1F66F5DY8G	34 T	739CH4424240	1F66F5DY5H	33 C
739HH4424038	1F66F5DY5G	36 H	739CH4424241	1F66F5DYXH	33 C
739KH4424039	1F66F5DY6G	35 K	739KH4424280	1F66F5DY9H	35 K
739HH4424040	1F66F5DY3G	36 H	739HH4424283	1F66F5DY4H	36 H
739YH4424041	1F66F5DYXG	36 Y	739CH4424284	1F66F5DY9H	33 C
739KH4424042	1F66F5DY8G	35 K	739HH4424286	1F66F5DY2H	36 H
739KH4424043	1F66F5DYXG	35 K	739KH4424288	1F66F5DY8H	35 K
739KH4424073	1F66F5DY0G	35 K	739YH4424289	1F66F5DY7G	36 Y
739TH4424074	1F66F5DY7G	34 T	739KH4424292	1F66F5DY9H	35 K
739XH4424075	1F66F5DY9G	36 X	739CH4424294	1F66F5DY7H	33 C
739KH4424077	1F66F5DY7G	35 K	739YH4424296	1F66F5DY6G	36 Y
739KH4424080	1F66F5DY9G	35 K	739KH4424298	1F66F5DY9H	35 K
739KH4424081	1F66F5DY6G	35 K	739KH4424300	1F66F5DYXH	35 K
739KH4424083	1F66F5DY2G	35 K	739KH4424303	1F66F5DY7H	35 K
739KH4424086	1F66F5DYXG	35 K	739HH4424304	1F66F5DY3H	36 H
739HH4424089	1F66F5DY0G	36 H	739XH4424307	1F66F5DY5G	36 X

Recall 191125REV
Affected Fleetwood Bounder Vehicles

Model Year 2017

UIN	CHASSIS VIN #	MODEL	UIN	CHASSIS VIN #	MODEL
739CH4424308	1F66F5DY2H0	33 C	739KH4424551	1F66F5DY9H0	35 K
739HH4424311	1F66F5DY4H0	36 H	739HH4424553	1F66F5DY0H0	36 H
739KH4424350	1F66F5DY9H0	35 K	739KH4424555	1F66F5DY8H0	35 K
739HH4424353	1F66F5DY0H0	36 H	739CH4424558	1F66F5DY4H0	33 C
739KH4424355	1F66F5DY0H0	35 K	739KH4424561	1F66F5DY2H0	35 K
739HH4424356	1F66F5DY5H0	36 H	739HH4424562	1F66F5DY0H0	36 H
739CH4424358	1F66F5DY4H0	33 C	739KH4424564	1F66F5DY2H0	35 K
739CH4424362	1F66F5DY0H0	33 C	739KH4424566	1F66F5DY4H0	35 K
739YH4424366	1F66F5DY3H0	36 Y	739HH4424568	1F66F5DY7H0	36 H
739KH4424370	1F66F5DY4H0	35 K	739KH4424569	1F66F5DY3H0	35 K
739HH4424371	1F66F5DY0H0	36 H	739KH4424573	1F66F5DY7H0	35 K
739KH4424372	1F66F5DY4H0	35 K	739KH4424615	1F66F5DY0H0	35 K
739HH4424374	1F66F5DY4H0	36 H	739HH4424617	1F66F5DYXH0	36 H
739CH4424376	1F66F5DY9H0	33 C	739HH4424620	1F66F5DY5H0	36 H
739YH4424377	1F66F5DY3G0	36 Y	739HH4424623	1F66F5DY2H0	36 H
739KH4424378	1F66F5DY7H0	35 K	739KH4424625	1F66F5DY2H0	35 K
739YH4424380	1F66F5DY2G0	36 Y	739XH4424628	1F66F5DY2G0	36 X
739CH4424420	1F66F5DY1H0	33 C	739KH4424632	1F66F5DY4H0	35 K
739KH4424421	1F66F5DY7H0	35 K	739KH4424634	1F66F5DY1H0	35 K
739HH4424423	1F66F5DY8H0	36 H	739KH4424636	1F66F5DYXH0	35 K
739CH4424425	1F66F5DY5H0	33 C	739YH4424638	1F66F5DY6G0	36 Y
739HH4424426	1F66F5DY9H0	36 H	739XH4424640	1F66F5DY8G0	36 X
739CH4424428	1F66F5DY2H0	33 C	739KH4424643	1F66F5DY1H0	35 K
739KH4424431	1F66F5DY1H0	35 K	739CH4424684	1F66F5DY3H0	33 C
739CH4424432	1F66F5DYXH0	33 C	739HH4424686	1F66F5DY4H0	36 H
739KH4424434	1F66F5DY0H0	35 K	739KH4424692	1F66F5DY4H0	35 K
739HH4424436	1F66F5DY7H0	36 H	739YH4424694	1F66F5DY8H0	36 Y
739CH4424439	1F66F5DY5H0	33 C	739KH4424695	1F66F5DY5H0	35 K
739KH4424440	1F66F5DY4H0	35 K	739KH4424700	1F66F5DY5H0	35 K
739KH4424442	1F66F5DY2H0	35 K	739KH4424701	1F66F5DY8H0	35 K
739HH4424444	1F66F5DY6H0	36 H	739KH4424703	1F66F5DY2H0	35 K
739CH4424446	1F66F5DY8H0	33 C	739YH4424706	1F66F5DY4G0	36 Y
739KH4424447	1F66F5DYXH0	35 K	739KH4424707	1F66F5DY7H0	35 K
739KH4424448	1F66F5DY0H0	35 K	739KH4424709	1F66F5DY7H0	35 K
739KH4424450	1F66F5DY8H0	35 K	739HH4424710	1F66F5DY1H0	36 H
739CH4424476	1F66F5DY1H0	33 C	739KH4424741	1F66F5DY2H0	35 K
739HH4424477	1F66F5DY6H0	36 H	739KH4424744	1F66F5DY9H0	35 K
739CH4424481	1F66F5DY4H0	33 C	739KH4424745	1F66F5DY4H0	35 K
739YH4424482	1F66F5DYXH0	36 Y	739KH4424747	1F66F5DY9H0	35 K
739KH4424485	1F66F5DY0H0	35 K	739KH4424748	1F66F5DY8H0	35 K
739HH4424489	1F66F5DY5H0	36 H	739KH4424750	1F66F5DY6H0	35 K
739KH4424492	1F66F5DYXH0	35 K	739KH4424753	1F66F5DY1H0	35 K
739KH4424495	1F66F5DY5H0	35 K	739YH4424754	1F66F5DY4G0	36 Y
739KH4424497	1F66F5DY3H0	35 K	739KH4424756	1F66F5DY0H0	35 K
739KH4424500	1F66F5DY9H0	35 K	739KH4424758	1F66F5DY9H0	35 K
739KH4424502	1F66F5DY6H0	35 K	739KH4424759	1F66F5DY6H0	35 K
739KH4424545	1F66F5DY2H0	35 K	739KH4424761	1F66F5DY8H0	35 K
739HH4424547	1F66F5DY9H0	36 H	739KH4424762	1F66F5DY3H0	35 K

Recall 191125REV
Affected Fleetwood Bounder Vehicles

Model Year 2017

UIN	CHASSIS VIN #	MODEL	UIN	CHASSIS VIN #	MODEL
739KH4424764	1F66F5DY6H	35 K	739KH4425025	1F66F5DY5H	35 K
739KH4424765	1F66F5DY5H	35 K	739HH4425027	1F66F5DY7H	36 H
739KH4424767	1F66F5DY9H	35 K	739KH4425029	1F66F5DY0H	35 K
739KH4424770	1F66F5DY0H	35 K	739YH4425030	1F66F5DY5H	36 Y
739KH4424772	1F66F5DY8H	35 K	739KH4425031	1F66F5DY8H	35 K
739CH4424813	1F66F5DY7H	33 C	739KH4425032	1F66F5DY9H	35 K
739YH4424815	1F66F5DY9G	36 Y	739HH4425063	1F66F5DY4H	36 H
739CH4424817	1F66F5DY5H	33 C	739KH4425064	1F66F5DYXH	35 K
739CH4424819	1F66F5DY0H	33 C	739KH4425066	1F66F5DY2H	35 K
739CH4424821	1F66F5DY3H	33 C	739CH4425073	1F66F5DY8H	33 C
739YH4424823	1F66F5DYXG	36 Y	739KH4425074	1F66F5DY0H	35 K
739CH4424825	1F66F5DY9H	33 C	739HH4425077	1F66F5DY6H	36 H
739KH4424827	1F66F5DYXH	35 K	739TH4425080	1F66F5DY1H	34 T
739CH4424829	1F66F5DY8H	33 C	739KH4425082	1F66F5DY6H	35 K
739KH4424833	1F66F5DY1H	35 K	739KH4425084	1F66F5DY6H	35 K
739KH4424835	1F66F5DY0H	35 K	739KH4425086	1F66F5DY1H	35 K
739KH4424837	1F66F5DY2H	35 K	739CH4425087	1F66F5DY6H	33 C
739KH4424840	1F66F5DY3H	35 K	739KH4425089	1F66F5DY1H	35 K
739CH4424887	1F66F5DY7H	33 C	739CH4425131	1F66F5DY5H	33 C
739KH4424889	1F66F5DY0H	35 K	739KH4425132	1F66F5DY9H	35 K
739KH4424891	1F66F5DY8H	35 K	739HH4425136	1F66F5DY7H	36 H
739CH4424893	1F66F5DY5H	33 C	739YH4425137	1F66F5DYXG	36 Y
739KH4424895	1F66F5DYXH	35 K	739KH4425139	1F66F5DY7H	35 K
739KH4424899	1F66F5DY2H	35 K	739YH4425141	1F66F5DY3G	36 Y
739KH4424903	1F66F5DY8H	35 K	739CH4425146	1F66F5DY4H	33 C
739KH4424905	1F66F5DY2H	35 K	739KH4425147	1F66F5DY5H	35 K
739KH4424909	1F66F5DY5H	35 K	739HH4425150	1F66F5DY3H	36 H
739YH4424911	1F66F5DY0G	36 Y	739HH4425152	1F66F5DY3H	36 H
739KH4424913	1F66F5DY2H	35 K	739KH4425154	1F66F5DY0H	35 K
739KH4424915	1F66F5DY0H	35 K	739KH4425156	1F66F5DY4H	35 K
739KH4424957	1F66F5DYXH	35 K	739KH4425157	1F66F5DY4H	35 K
739HH4424959	1F66F5DY9H	36 H	739KH4425159	1F66F5DY5H	35 K
739CH4424960	1F66F5DY1H	33 C	739PH4425160	1F66F5DY2H	35 P
739HH4424961	1F66F5DY5H	36 H	739KH4425161	1F66F5DY4H	35 K
739HH4424964	1F66F5DY7H	36 H	739HH4425205	1F66F5DY7H	36 H
739HH4424966	1F66F5DY7H	36 H	739CH4425207	1F66F5DY3H	33 C
739YH4425001	1F66F5DY2G	36 Y	739HH4425209	1F66F5DY8H	36 H
739KH4425003	1F66F5DY0H	35 K	739CH4425212	1F66F5DY1H	33 C
739HH4425006	1F66F5DYXH	36 H	739HH4425213	1F66F5DY0H	36 H
739CH4425010	1F66F5DY3H	33 C	739KH4425215	1F66F5DY8H	35 K
739YH4425011	1F66F5DY6G	36 Y	739HH4425217	1F66F5DY3H	36 H
739YH4425012	1F66F5DY2G	36 Y	739KH4425219	1F66F5DYXH	35 K
739HH4425014	1F66F5DY1H	36 H	739KH4425221	1F66F5DY6H	35 K
739KH4425015	1F66F5DY1H	35 K	739KH4425224	1F66F5DY4H	35 K
739HH4425018	1F66F5DY9H	36 H	739KH4425225	1F66F5DY0H	35 K
739CH4425019	1F66F5DY2H	33 C	739KH4425227	1F66F5DY8H	35 K
739YH4425022	1F66F5DY5G	36 Y	739HH4425228	1F66F5DY0H	36 H
739KH4425023	1F66F5DY7H	35 K	739CH4425229	1F66F5DY1H	33 C

Recall 191125REV
Affected Fleetwood Bounder Vehicles

Model Year 2017

UIN	CHASSIS VIN #	MODEL	UIN	CHASSIS VIN #	MODEL
739XH4425230	1F66F5DY8G	36 X	739HH4425470	1F66F5DY6H	36 H
739CH4425252	1F66F5DY3H	33 C	739KH4425472	1F66F5DY3H	35 K
739CH4425253	1F66F5DY5H	33 C	739KH4425474	1F66F5DY5H	35 K
739XH4425255	1F66F5DY6G	36 X	739YH4425476	1F66F5DY3H	36 Y
739HH4425257	1F66F5DY6H	36 H	739KH4425477	1F66F5DY1H	35 K
739CH4425258	1F66F5DY6H	33 C	739HH4425480	1F66F5DY6H	36 H
739KH4425260	1F66F5DY4H	35 K	739KH4425481	1F66F5DY7H	35 K
739HH4425262	1F66F5DY5H	36 H	739KH4425484	1F66F5DY4H	35 K
739KH4425266	1F66F5DY1H	35 K	739KH4425486	1F66F5DY8H	35 K
739KH4425267	1F66F5DYXH	35 K	739KH4425488	1F66F5DY0H	35 K
739KH4425269	1F66F5DYXH	35 K	739KH4425492	1F66F5DY0H	35 K
739KH4425271	1F66F5DY8H	35 K	739HH4425494	1F66F5DY7H	36 H
739KH4425275	1F66F5DY3H	35 K	739CH4425495	1F66F5DY2H	33 C
739KH4425277	1F66F5DYXH	35 K	739KH4425534	1F66F5DY5H	35 K
739KH4425278	1F66F5DY3H	35 K	739HH4425536	1F66F5DY9H	36 H
739HH4425280	1F66F5DY2H	36 H	739CH4425538	1F66F5DY1H	33 C
739KH4425282	1F66F5DY8H	35 K	739KH4425540	1F66F5DYXH	35 K
739CH4425326	1F66F5DYXH	33 C	739KH4425542	1F66F5DY6H	35 K
739CH4425327	1F66F5DY1H	33 C	739KH4425544	1F66F5DY2H	35 K
739KH4425329	1F66F5DY1H	35 K	739KH4425549	1F66F5DY7H	35 K
739KH4425331	1F66F5DY4H	35 K	739HH4425550	1F66F5DY4H	36 H
739KH4425332	1F66F5DY1H	35 K	739KH4425552	1F66F5DY9H	35 K
739KH4425334	1F66F5DY0H	35 K	739HH4425553	1F66F5DY0H	36 H
739HH4425336	1F66F5DY5H	36 H	739CH4425555	1F66F5DY6H	33 C
739HH4425340	1F66F5DY1H	36 H	739HH4425556	1F66F5DY2H	36 H
739KH4425341	1F66F5DYXH	35 K	739KH4425559	1F66F5DY2H	35 K
739KH4425345	1F66F5DY3H	35 K	739HH4425561	1F66F5DY5H	36 H
739HH4425349	1F66F5DY5H	36 H	739CH4425562	1F66F5DY4H	33 C
739YH4425351	1F66F5DY4G	36 Y	739CH4425563	1F66F5DY4H	33 C
739KH4425352	1F66F5DY5H	35 K	739CH4425565	1F66F5DY3H	33 C
739HH4425354	1F66F5DYXH	36 H	739CH4425587	1F66F5DY9H	33 C
739KH4425356	1F66F5DYXH	35 K	739HH4425589	1F66F5DY2H	36 H
739CH4425400	1F66F5DY8H	33 C	739CH4425592	1F66F5DY3H	33 C
739HH4425401	1F66F5DY7H	36 H	739HH4425593	1F66F5DY5H	36 H
739CH4425403	1F66F5DYXH	33 C	739XH4425595	1F66F5DY7H	36 X
739HH4425405	1F66F5DY5H	36 H	739HH4425597	1F66F5DY6H	36 H
739KH4425406	1F66F5DY3H	35 K	739CH4425600	1F66F5DYXH	33 C
739KH4425408	1F66F5DY3H	35 K	739HH4425601	1F66F5DY9H	36 H
739XH4425409	1F66F5DY6H	36 X	739HH4425603	1F66F5DY6H	36 H
739KH4425411	1F66F5DY5H	35 K	739KH4425604	1F66F5DY9H	35 K
739KH4425413	1F66F5DY2H	35 K	739KH4425607	1F66F5DY3H	35 K
739KH4425417	1F66F5DY1H	35 K	739XH4425608	1F66F5DYXH	36 X
739HH4425421	1F66F5DY2H	36 H	739HH4425609	1F66F5DY4H	36 H
739KH4425422	1F66F5DY3H	35 K	739KH4425610	1F66F5DY8H	35 K
739KH4425424	1F66F5DY6H	35 K	739HH4425615	1F66F5DY7H	36 H
739KH4425427	1F66F5DYXH	35 K	739KH4425617	1F66F5DY1H	35 K
739HH4425428	1F66F5DY6H	36 H	739HH4425618	1F66F5DY4H	36 H
739HH4425430	1F66F5DY4H	36 H	739KH4425652	1F66F5DYXH	35 K
739CH4425466	1F66F5DY2H	33 C	739CH4425655	1F66F5DY2H	33 C

Recall 191125REV
Affected Fleetwood Bounder Vehicles

Model Year 2017

UIN	CHASSIS VIN #	MODEL	UIN	CHASSIS VIN #	MODEL
739YH4425657	1F66F5DY1H0	36 Y	739KH4425912	1F66F5DY1H0	35 K
739CH4425658	1F66F5DY0H0	33 C	739KH4425914	1F66F5DY4H0	35 K
739CH4425660	1F66F5DY8H0	33 C	739CH4425975	1F66F5DY3H0	33 C
739KH4425663	1F66F5DY1H0	35 K	739CH4425977	1F66F5DY1H0	33 C
739HH4425664	1F66F5DY1H0	36 H	739CH4425980	1F66F5DY3H0	33 C
739KH4425666	1F66F5DY5H0	35 K	739PH4425982	1F66F5DY2H0	35 P
739KH4425668	1F66F5DY7H0	35 K	739CH4425985	1F66F5DY2H0	33 C
739HH4425669	1F66F5DY2H0	36 H	739KH4425989	1F66F5DY3H0	35 K
739KH4425671	1F66F5DY3H0	35 K	739HH4426060	1F66F5DY8H0	36 H
739HH4425674	1F66F5DY9H0	36 H	739PH4426061	1F66F5DY1H0	35 P
739CH4425701	1F66F5DY2H0	33 C	739XH4426064	1F66F5DY0H0	36 X
739HH4425702	1F66F5DY6H0	36 H	739PH4426066	1F66F5DY3H0	35 P
739YH4425704	1F66F5DY1H0	36 Y	739HH4426070	1F66F5DY9H0	36 H
739CH4425705	1F66F5DY1H0	33 C	739PH4426085	1F66F5DY5H0	35 P
739CH4425707	1F66F5DY6H0	33 C	739CH4426093	1F66F5DY4H0	33 C
739HH4425710	1F66F5DY6H0	36 H	739HH4426094	1F66F5DY2H0	36 H
739HH4425713	1F66F5DY4H0	36 H	739PH4426097	1F66F5DY0H0	35 P
739CH4425715	1F66F5DY2H0	33 C	739KH4426098	1F66F5DY7H0	35 K
739KH4425749	1F66F5DY6H0	35 K	739HH4426102	1F66F5DY5H0	36 H
739HH4425750	1F66F5DY8H0	36 H	739XH4426107	1F66F5DY0G0	36 X
739CH4425754	1F66F5DYXH0	33 C	739PH4426110	1F66F5DY5H0	35 P
739HH4425755	1F66F5DY1H0	36 H	739KH4426111	1F66F5DY4H0	35 K
739CH4425759	1F66F5DY8H0	33 C	739YH4426117	1F66F5DY6G0	36 Y
739KH4425763	1F66F5DY2H0	35 K	739KH4426118	1F66F5DY7H0	35 K
739XH4425765	1F66F5DY8G0	36 X	739PH4426121	1F66F5DY8H0	35 P
739KH4425767	1F66F5DY5H0	35 K	739HH4426161	1F66F5DY0H0	36 H
739KH4425769	1F66F5DY6H0	35 K	739KH4426166	1F66F5DY5H0	35 K
739KH4425771	1F66F5DY3H0	35 K	739KH4426167	1F66F5DY5H0	35 K
739KH4425774	1F66F5DY5H0	35 K	739KH4426169	1F66F5DY1H0	35 K
739HH4425776	1F66F5DYXH0	36 H	739KH4426173	1F66F5DY3H0	35 K
739XH4425778	1F66F5DY7H0	36 X	739KH4426174	1F66F5DYXH0	35 K
739CH4425813	1F66F5DY8H0	33 C	739PH4426175	1F66F5DY6H0	35 P
739HH4425815	1F66F5DYXH0	36 H	739PH4426177	1F66F5DY7H0	35 P
739YH4425820	1F66F5DY2H0	36 Y	739PH4426179	1F66F5DY4H0	35 P
739KH4425825	1F66F5DY5H0	35 K	739KH4426181	1F66F5DY4H0	35 K
739KH4425828	1F66F5DY9H0	35 K	739PH4426182	1F66F5DYXH0	35 P
739KH4425832	1F66F5DY4H0	35 K	739KH4426183	1F66F5DY7H0	35 K
739YH4425836	1F66F5DY8H0	36 Y	739KH4426184	1F66F5DY5H0	35 K
739XH4425841	1F66F5DY7G0	36 X	739KH4426187	1F66F5DY6H0	35 K
739CH4425844	1F66F5DY7H0	33 C	739KH4426189	1F66F5DY2H0	35 K
739KH4425846	1F66F5DY9H0	35 K	739KH4426192	1F66F5DY5H0	35 K
739KH4425848	1F66F5DY1H0	35 K	739KH4426243	1F66F5DY0H0	35 K
739KH4425889	1F66F5DY0H0	35 K	739PH4426245	1F66F5DY5H0	35 P
739KH4425891	1F66F5DY0H0	35 K	739KH4426246	1F66F5DY9H0	35 K
739KH4425895	1F66F5DY3H0	35 K	739HH4426247	1F66F5DY1H0	36 H
739KH4425901	1F66F5DYXH0	35 K	739PH4426249	1F66F5DY7H0	35 P
739PH4425903	1F66F5DY6H0	35 P	739KH4426250	1F66F5DY7H0	35 K
739KH4425905	1F66F5DY3H0	35 K	739PH4426253	1F66F5DY1H0	35 P
739KH4425908	1F66F5DY8H0	35 K			

Recall 191125REV
Affected Fleetwood Bounder Vehicles

Model Year 2017

UIN	CHASSIS VIN #	MODEL	UIN	CHASSIS VIN #	MODEL
739KH4426254	1F66F5DY8H0	35 K	739PH4426463	1F66F5DY9H	35 P
739HH4426256	1F66F5DY6H0	36 H	739KH4426465	1F66F5DY2H	35 K
739PH4426258	1F66F5DY6H0	35 P	739PH4426466	1F66F5DY2H	35 P
739KH4426259	1F66F5DY7H0	35 K	739CH4426504	1F66F5DY1H	33 C
739HH4426260	1F66F5DY6H0	36 H	739HH4426505	1F66F5DY8H	36 H
739PH4426262	1F66F5DY6H0	35 P	739CH4426509	1F66F5DY2H	33 C
739KH4426263	1F66F5DY2H0	35 K	739PH4426510	1F66F5DY0H	35 P
739KH4426265	1F66F5DY0H0	35 K	739HH4426511	1F66F5DY3H	36 H
739PH4426266	1F66F5DY7H0	35 P	739PH4426514	1F66F5DYXH	35 P
739KH4426268	1F66F5DY0H0	35 K	739KH4426515	1F66F5DYXH	35 K
739HH4426269	1F66F5DY0H0	36 H	739HH4426516	1F66F5DY4H	36 H
739PH4426270	1F66F5DY2H0	35 P	739PH4426519	1F66F5DY4H	35 P
739KH4426272	1F66F5DY7H0	35 K	739KH4426520	1F66F5DY9H	35 K
739PH4426274	1F66F5DY8H0	35 P	739PH4426525	1F66F5DYXH	35 P
739PH4426287	1F66F5DY3H0	35 P	739KH4426526	1F66F5DY8H	35 K
739PH4426292	1F66F5DY0H0	35 P	739KH4426530	1F66F5DY1H	35 K
739HH4426293	1F66F5DY3H0	36 H	739CH4426578	1F66F5DY4H	33 C
739CH4426294	1F66F5DYXH0	33 C	739KH4426579	1F66F5DY7H	35 K
739PH4426296	1F66F5DY0H0	35 P	739PH4426580	1F66F5DY8H	35 P
739KH4426297	1F66F5DY7H0	35 K	739KH4426582	1F66F5DY1H	35 K
739KH4426301	1F66F5DY6H0	35 K	739KH4426585	1F66F5DY5H	35 K
739KH4426304	1F66F5DY1H0	35 K	739CH4426586	1F66F5DY1H	33 C
739KH4426308	1F66F5DY2H0	35 K	739PH4426587	1F66F5DY7H	35 P
739KH4426311	1F66F5DY5H0	35 K	739KH4426588	1F66F5DY6H	35 K
739CH4426315	1F66F5DYXH0	33 C	739KH4426594	1F66F5DY8H	35 K
739CH4426359	1F66F5DY6H0	33 C	739PH4426598	1F66F5DY5H	35 P
739HH4426360	1F66F5DY8H0	36 H	739KH4426599	1F66F5DY2H	35 K
739PH4426362	1F66F5DY9H0	35 P	739KH4426606	1F66F5DY9H	35 K
739HH4426365	1F66F5DY2H0	36 H	739KH4426609	1F66F5DY0H	35 K
739KH4426368	1F66F5DYXH0	35 K	739CH4426653	1F66F5DY2H	33 C
739PH4426369	1F66F5DY6H0	35 P	739PH4426654	1F66F5DY7H	35 P
739KH4426372	1F66F5DY8H0	35 K	739KH4426655	1F66F5DY0H	35 K
739PH4426373	1F66F5DY7H0	35 P	739KH4426658	1F66F5DY9H	35 K
739KH4426375	1F66F5DY3H0	35 K	739HH4426659	1F66F5DY5H	36 H
739KH4426378	1F66F5DY7H0	35 K	739CH4426662	1F66F5DY6H	33 C
739KH4426382	1F66F5DY9H0	35 K	739KH4426663	1F66F5DY5H	35 K
739KH4426387	1F66F5DY7H0	35 K	739KH4426664	1F66F5DY7H	35 K
739YH4426389	1F66F5DY5H0	36 Y	739KH4426667	1F66F5DY8H	35 K
739KH4426440	1F66F5DY1H0	35 K	739KH4426668	1F66F5DYXH	35 K
739HH4426442	1F66F5DY6H0	36 H	739KH4426669	1F66F5DY0H	35 K
739CH4426444	1F66F5DY6H0	33 C	739PH4426671	1F66F5DY0H	35 P
739KH4426446	1F66F5DY2H0	35 K	739KH4426675	1F66F5DY9H	35 K
739KH4426448	1F66F5DY7H0	35 K	739PH4426676	1F66F5DY7H	35 P
739PH4426449	1F66F5DY6H0	35 P	739KH4426677	1F66F5DY1H	35 K
739HH4426451	1F66F5DY8H0	36 H	739HH4426680	1F66F5DY6H	36 H
739CH4426453	1F66F5DY2H0	33 C	739HH4426683	1F66F5DYXH	36 H
739KH4426454	1F66F5DY3H0	35 K	739KH4426726	1F66F5DY9H	35 K
739HH4426456	1F66F5DYXH0	36 H	739KH4426727	1F66F5DY6H	35 K
739KH4426458	1F66F5DY2H0	35 K	739HJ4426748	1F66F5DY8H	36 H

Recall 191125REV
Affected Fleetwood Bounder Vehicles

Model Year 2018

UIN	CHASSIS VIN #	MODEL	UIN	CHASSIS VIN #	MODEL
739CJ4426751	1F66F5DY7H	33 C	739KJ4426947	1F66F5DY0H	35 K
739PJ4426753	1F66F5DY1H	35 P	739HJ4426948	1F66F5DY4H	36 H
739KJ4426754	1F66F5DY5H	35 K	739CJ4426952	1F66F5DY6H	33 C
739PJ4426758	1F66F5DY6H	35 P	739KJ4426954	1F66F5DY0H	35 K
739KJ4426759	1F66F5DY6H	35 K	739PJ4426956	1F66F5DY2H	35 P
739KJ4426762	1F66F5DY5H	35 K	739HJ4426957	1F66F5DYXH	36 H
739PJ4426763	1F66F5DY0H	35 P	739KJ4426959	1F66F5DYXH	35 K
739HJ4426765	1F66F5DY6H	36 H	739PJ4426961	1F66F5DY1H	35 P
739CJ4426768	1F66F5DY6H	33 C	739KJ4426962	1F66F5DY7H	35 K
739KJ4426769	1F66F5DY3H	35 K	739HJ4426963	1F66F5DY1H	36 H
739KJ4426770	1F66F5DY9H	35 K	739PJ4426966	1F66F5DY5H	35 P
739PJ4426773	1F66F5DY3H	35 P	739KJ4426967	1F66F5DY6H	35 K
739PJ4426777	1F66F5DY9H	35 P	739PJ4426970	1F66F5DY9H	35 P
739KJ4426778	1F66F5DY3H	35 K	739CJ4427016	1F66F5DY6H	33 C
739HJ4426779	1F66F5DY4H	36 H	739HJ4427017	1F66F5DY7H	36 H
739PJ4426781	1F66F5DYXH	35 P	739PJ4427018	1F66F5DY7H	35 P
739CJ4426814	1F66F5DY5H	33 C	739KJ4427021	1F66F5DY2H	35 K
739PJ4426817	1F66F5DY1H	35 P	739KJ4427023	1F66F5DY6H	35 K
739HJ4426818	1F66F5DY9H	36 H	739PJ4427026	1F66F5DY5H	35 P
739CJ4426821	1F66F5DY7H	33 C	739HJ4427027	1F66F5DY3H	36 H
739PJ4426822	1F66F5DY6H	35 P	739KJ4427030	1F66F5DY9H	35 K
739KJ4426826	1F66F5DY2H	35 K	739PJ4427032	1F66F5DY2H	35 P
739PJ4426827	1F66F5DY9H	35 P	739HJ4427035	1F66F5DYXH	36 H
739HJ4426831	1F66F5DY0H	36 H	739KJ4427036	1F66F5DY4H	35 K
739KJ4426832	1F66F5DY0H	35 K	739PJ4427041	1F66F5DY3H	35 P
739PJ4426834	1F66F5DY6H	35 P	739CJ4427042	1F66F5DY0H	33 C
739PJ4426837	1F66F5DYXH	35 P	739KJ4427043	1F66F5DY4H	35 K
739KJ4426841	1F66F5DY3H	35 K	739HJ4427044	1F66F5DY8H	36 H
739PJ4426842	1F66F5DY8H	35 P	739PJ4427045	1F66F5DY2H	35 P
739KJ4426844	1F66F5DY0H	35 K	739PJ4427048	1F66F5DY3H	35 P
739CJ4426870	1F66F5DY2H	33 C	739CJ4427091	1F66F5DY4H	33 C
739PJ4426871	1F66F5DY1H	35 P	739PJ4427094	1F66F5DY1H	35 P
739HJ4426872	1F66F5DY6H	36 H	739KJ4427095	1F66F5DY1H	35 K
739CJ4426877	1F66F5DY0H	33 C	739HJ4427096	1F66F5DY0H	36 H
739PJ4426878	1F66F5DY4H	35 P	739PJ4427098	1F66F5DY4H	35 P
739KJ4426879	1F66F5DYXH	35 K	739CJ4427100	1F66F5DY1H	33 C
739HJ4426880	1F66F5DY8H	36 H	739HJ4427103	1F66F5DY7H	36 H
739KJ4426883	1F66F5DY2H	35 K	739CJ4427104	1F66F5DY0H	33 C
739KJ4426887	1F66F5DY9H	35 K	739PJ4427105	1F66F5DYXH	35 P
739HJ4426888	1F66F5DY7H	36 H	739CJ4427106	1F66F5DY8H	33 C
739PJ4426892	1F66F5DY5H	35 P	739KJ4427107	1F66F5DYXH	35 K
739KJ4426893	1F66F5DYXH	35 K	739HJ4427108	1F66F5DYXH	36 H
739PJ4426897	1F66F5DY7H	35 P	739PJ4427109	1F66F5DY9H	35 P
739KJ4426899	1F66F5DY9H	35 K	739HJ4427111	1F66F5DY6H	36 H
739PJ4426902	1F66F5DY9H	35 P	739CJ4427112	1F66F5DY0H	33 C
739PJ4426943	1F66F5DYXH	35 P	739PJ4427113	1F66F5DY8H	35 P
739CJ4426944	1F66F5DY2H	33 C	739KJ4427115	1F66F5DY4H	35 K
739PJ4426946	1F66F5DY1H	35 P	739HJ4427116	1F66F5DY2H	36 H

Recall 191125REV
Affected Fleetwood Bounder Vehicles

Model Year 2018

UIN	CHASSIS VIN #	MODEL	UIN	CHASSIS VIN #	MODEL
739KJ4427118	1F66F5DY7H0	35 K	739KJ4427398	1F66F5DY3H0	35 K
739CJ4427120	1F66F5DY2H0	33 C	739CJ4427400	1F66F5DY1J0	33 C
739CJ4427121	1F66F5DY9H0	33 C	739HJ4427401	1F66F5DY5H0	36 H
739CJ4427122	1F66F5DY7H0	33 C	739PJ4427403	1F66F5DY0H0	35 P
739PJ4427167	1F66F5DY0H0	35 P	739HJ4427407	1F66F5DY8H0	36 H
739KJ4427170	1F66F5DY6H0	35 K	739KJ4427411	1F66F5DY5H0	35 K
739HJ4427172	1F66F5DY3H0	36 H	739KJ4427413	1F66F5DY1H0	35 K
739PJ4427173	1F66F5DY6H0	35 P	739CJ4427415	1F66F5DY5J0	33 C
739PJ4427179	1F66F5DY8H0	35 P	739HJ4427416	1F66F5DY5H0	36 H
739KJ4427180	1F66F5DY0H0	35 K	739KJ4427419	1F66F5DY9H0	35 K
739HJ4427181	1F66F5DYXH0	36 H	739CJ4427422	1F66F5DYXJ0	33 C
739CJ4427185	1F66F5DY3H0	33 C	739KJ4427466	1F66F5DY3H0	35 K
739HJ4427186	1F66F5DY5H0	36 H	739HJ4427467	1F66F5DY1H0	36 H
739KJ4427189	1F66F5DY0H0	35 K	739CJ4427468	1F66F5DYXH0	33 C
739KJ4427193	1F66F5DY2H0	35 K	739PJ4427472	1F66F5DY5H0	35 P
739CJ4427197	1F66F5DY1H0	33 C	739KJ4427474	1F66F5DY4H0	35 K
739CJ4427199	1F66F5DY6H0	33 C	739HJ4427475	1F66F5DY9H0	36 H
739CJ4427200	1F66F5DY8H0	33 C	739PJ4427477	1F66F5DY1H0	35 P
739CJ4427244	1F66F5DY4H0	33 C	739KJ4427479	1F66F5DY6H0	35 K
739PJ4427245	1F66F5DY2H0	35 P	739PJ4427480	1F66F5DY7H0	35 P
739KJ4427246	1F66F5DY7H0	35 K	739CJ4427482	1F66F5DY2J0	33 C
739HJ4427248	1F66F5DYXH0	36 H	739PJ4427486	1F66F5DY9H0	35 P
739KJ4427249	1F66F5DY6H0	35 K	739KJ4427488	1F66F5DY0H0	35 K
739KJ4427251	1F66F5DY0H0	35 K	739HJ4427490	1F66F5DY2H0	36 H
739PJ4427253	1F66F5DY1H0	35 P	739PJ4427492	1F66F5DY9H0	35 P
739CJ4427254	1F66F5DYXH0	33 C	739HJ4427493	1F66F5DY7H0	36 H
739HJ4427255	1F66F5DY0H0	36 H	739KJ4427494	1F66F5DY9H0	35 K
739KJ4427256	1F66F5DY7H0	35 K	739CJ4427540	1F66F5DY0J0	33 C
739KJ4427258	1F66F5DY9H0	35 K	739HJ4427541	1F66F5DY7H0	36 H
739PJ4427260	1F66F5DY1H0	35 P	739KJ4427545	1F66F5DY8H0	35 K
739KJ4427261	1F66F5DY4H0	35 K	739HJ4427549	1F66F5DY5H0	36 H
739HJ4427263	1F66F5DY0H0	36 H	739KJ4427552	1F66F5DY6H0	35 K
739HJ4427266	1F66F5DY2H0	36 H	739CJ4427555	1F66F5DYXJ0	33 C
739KJ4427270	1F66F5DY2H0	35 K	739KJ4427558	1F66F5DY9H0	35 K
739CJ4427273	1F66F5DY4H0	33 C	739KJ4427562	1F66F5DY8H0	35 K
739KJ4427318	1F66F5DY3H0	35 K	739KJ4427567	1F66F5DY1H0	35 K
739HJ4427322	1F66F5DY7H0	36 H	739HJ4427616	1F66F5DY0H0	36 H
739KJ4427326	1F66F5DY5H0	35 K	739KJ4427617	1F66F5DY5H0	35 K
739KJ4427328	1F66F5DY1H0	35 K	739KJ4427619	1F66F5DY1H0	35 K
739CJ4427335	1F66F5DYXH0	33 C	739KJ4427626	1F66F5DY8H0	35 K
739HJ4427336	1F66F5DYXH0	36 H	739HJ4427630	1F66F5DYXH0	36 H
739KJ4427338	1F66F5DY5H0	35 K	739KJ4427633	1F66F5DY0H0	35 K
739KJ4427341	1F66F5DY7H0	35 K	739PJ4427638	1F66F5DY2H0	35 P
739KJ4427343	1F66F5DY2H0	35 K	739HJ4427643	1F66F5DY4H0	36 H
739KJ4427345	1F66F5DY4H0	35 K	739CJ4427690	1F66F5DY8J0	33 C
739KJ4427348	1F66F5DY9H0	35 K	739KJ4427692	1F66F5DY5H0	35 K
739CJ4427392	1F66F5DY3H0	33 C	739KJ4427694	1F66F5DY3H0	35 K
739PJ4427393	1F66F5DY0H0	35 P	739KJ4427695	1F66F5DY2H0	35 K

Recall 191125REV
Affected Fleetwood Bounder Vehicles

Model Year 2018

UIN	CHASSIS VIN #	MODEL	UIN	CHASSIS VIN #	MODEL
739HJ4427698	1F66F5DY3H	36 H	739KJ4427931	1F66F5DY7J0A	35 K
739KJ4427699	1F66F5DY9H	35 K	739HJ4427933	1F66F5DY3J0A	36 H
739KJ4427700	1F66F5DY2H	35 K	739KJ4427935	1F66F5DY4J0A	35 K
739KJ4427704	1F66F5DY4H	35 K	739KJ4427938	1F66F5DY6J0A	35 K
739HJ4427706	1F66F5DY1H	36 H	739KJ4427939	1F66F5DY6J0A	35 K
739KJ4427707	1F66F5DY0H	35 K	739PJ4427940	1F66F5DY3H0	35 P
739KJ4427708	1F66F5DY6H	35 K	739PJ4427941	1F66F5DY5H0	35 P
739KJ4427709	1F66F5DY6H	35 K	739KJ4427942	1F66F5DY2J0A	35 K
739CJ4427710	1F66F5DY1J	33 C	739KJ4427943	1F66F5DY6J0A	35 K
739KJ4427711	1F66F5DY7H	35 K	739PJ4427946	1F66F5DYXH0	35 P
739KJ4427712	1F66F5DY0H	35 K	739PJ4427947	1F66F5DY1H0	35 P
739KJ4427714	1F66F5DYXH	35 K	739HJ4427950	1F66F5DY2J0A	36 H
739KJ4427715	1F66F5DY4H	35 K	739KJ4427998	1F66F5DY9H0	35 K
739KJ4427716	1F66F5DY4H	35 K	739KJ4427999	1F66F5DY0J0A	35 K
739KJ4427718	1F66F5DY2J	35 K	739KJ4428010	1F66F5DYXJ0A	35 K
739KJ4427719	1F66F5DY4J	35 K	739KJ4428011	1F66F5DY6J0A	35 K
739KJ4427720	1F66F5DY6J	35 K	739KJ4428016	1F66F5DY2J0A	35 K
739CJ4427767	1F66F5DY5J	33 C	739KJ4428017	1F66F5DY7J0A	35 K
739PJ4427770	1F66F5DY4H	35 P	739KJ4428018	1F66F5DY5J0A	35 K
739KJ4427771	1F66F5DY4J	35 K	739KJ4428021	1F66F5DY0J0A	35 K
739PJ4427776	1F66F5DY2H	35 P	739KJ4428022	1F66F5DY8J0A	35 K
739PJ4427779	1F66F5DY4H	35 P	739KJ4428026	1F66F5DYXJ0A	35 K
739HJ4427782	1F66F5DY5H	36 H	739KJ4428027	1F66F5DY9J0A	35 K
739HJ4427784	1F66F5DY3H	36 H	739KJ4428028	1F66F5DY3J0A	35 K
739CJ4427785	1F66F5DY9J	33 C	739KJ4428029	1F66F5DY3J0A	35 K
739KJ4427787	1F66F5DY5J	35 K	739PJ4428071	1F66F5DY8H0	35 P
739HJ4427788	1F66F5DY3H	36 H	739KJ4428072	1F66F5DY4J0A	35 K
739KJ4427791	1F66F5DY6J	35 K	739PJ4428081	1F66F5DY8H0	35 P
739PJ4427792	1F66F5DY6H	35 P	739KJ4428085	1F66F5DY0J0A	35 K
739KJ4427793	1F66F5DY8J	35 K	739PJ4428088	1F66F5DY0H0	35 P
739KJ4427795	1F66F5DY1J	35 K	739KJ4428089	1F66F5DY6J0A	35 K
739PJ4427796	1F66F5DY6H	35 P	739KJ4428090	1F66F5DY7J0A	35 K
739CJ4427843	1F66F5DY7J	33 C	739KJ4428091	1F66F5DY9J0A	35 K
739KJ4427845	1F66F5DY6J	35 K	739PJ4428094	1F66F5DY0H0	35 P
739HJ4427846	1F66F5DY4H	36 H	739PJ4428095	1F66F5DY8H0	35 P
739KJ4427852	1F66F5DYXJ	35 K	739KJ4428099	1F66F5DYXJ0A	35 K
739KJ4427856	1F66F5DY3J	35 K	739PJ4428100	1F66F5DY6H0	35 P
739CJ4427860	1F66F5DY5J	33 C	739KJ4428102	1F66F5DY3J0A	35 K
739HJ4427861	1F66F5DY4J	36 H	739PJ4428156	1F66F5DY3H0	35 P
739HJ4427865	1F66F5DY6J	36 H	739KJ4428157	1F66F5DY6J0A	35 K
739KJ4427869	1F66F5DYXJ	35 K	739KJ4428161	1F66F5DY6J0A	35 K
739CJ4427923	1F66F5DY5J	33 C	739KJ4428163	1F66F5DYXJ0A	35 K
739CJ4427924	1F66F5DY7J	33 C	739KJ4428165	1F66F5DY2J0A	35 K
739CJ4427925	1F66F5DY0J	33 C	739KJ4428166	1F66F5DY1J0A	35 K
739PJ4427926	1F66F5DY2H	35 P	739HJ4428169	1F66F5DY3J0A	36 H
739CJ4427928	1F66F5DY5J	33 C	739HJ4428170	1F66F5DY1J0A	36 H
739KJ4427929	1F66F5DY9J	35 K	739HJ4428175	1F66F5DY9J0A	36 H
739KJ4427930	1F66F5DY1J	35 K	739CJ4428224	1F66F5DY1J0A	33 C

Recall 191125REV
Affected Fleetwood Bounder Vehicles

Model Year 2018

UIN	CHASSIS VIN #	MODEL	UIN	CHASSIS VIN #	MODEL
739CJ4428225	1F66F5DY4J0	33 C	739KJ4428546	1F66F5DY1J	35 K
739CJ4428226	1F66F5DYXJ0	33 C	739KJ4428547	1F66F5DY1J	35 K
739KJ4428234	1F66F5DY4J0	35 K	739KJ4428548	1F66F5DY9J	35 K
739PJ4428237	1F66F5DY9J0	35 P	739KJ4428549	1F66F5DY1J	35 K
739PJ4428238	1F66F5DY2J0	35 P	739KJ4428550	1F66F5DY6J	35 K
739CJ4428248	1F66F5DY1J0	33 C	739HJ4428616	1F66F5DY7J	36 H
739CJ4428249	1F66F5DYXJ0	33 C	739HJ4428617	1F66F5DY5J	36 H
739HJ4428250	1F66F5DY2J0	36 H	739HJ4428618	1F66F5DY1J	36 H
739HJ4428251	1F66F5DY7J0	36 H	739KJ4428627	1F66F5DYXJ	35 K
739HJ4428252	1F66F5DY4J0	36 H	739KJ4428628	1F66F5DY5J	35 K
739CJ4428296	1F66F5DY5J0	33 C	739KJ4428629	1F66F5DYXJ	35 K
739CJ4428297	1F66F5DY4J0	33 C	739HJ4428636	1F66F5DY3J	36 H
739KJ4428298	1F66F5DY9J0	35 K	739PJ4428693	1F66F5DY9J	35 P
739KJ4428299	1F66F5DYXJ0	35 K	739CJ4428694	1F66F5DY3J	33 C
739KJ4428300	1F66F5DY5J0	35 K	739PJ4428696	1F66F5DY9J	35 P
739HJ4428318	1F66F5DY7J0	36 H	739KJ4428697	1F66F5DY3J	35 K
739HJ4428319	1F66F5DY8J0	36 H	739KJ4428698	1F66F5DY8J	35 K
739HJ4428320	1F66F5DY5J0	36 H	739PJ4428699	1F66F5DY1J	35 P
739CJ4428374	1F66F5DY6J0	33 C	739KJ4428700	1F66F5DY2J	35 K
739CJ4428375	1F66F5DY8J0	33 C	739KJ4428701	1F66F5DY6J	35 K
739CJ4428376	1F66F5DY8J0	33 C	739KJ4428702	1F66F5DY5J	35 K
739KJ4428378	1F66F5DY0J0	35 K	739PJ4428706	1F66F5DY5J	35 P
739KJ4428379	1F66F5DY3J0	35 K	739HJ4428708	1F66F5DY1J	36 H
739KJ4428380	1F66F5DY4J0	35 K	739PJ4428775	1F66F5DY4J	35 P
739KJ4428381	1F66F5DY0J0	35 K	739KJ4428776	1F66F5DY1J	35 K
739KJ4428382	1F66F5DY5J0	35 K	739KJ4428777	1F66F5DY9J	35 K
739KJ4428383	1F66F5DY1J0	35 K	739KJ4428778	1F66F5DY8J	35 K
739KJ4428384	1F66F5DY1J0	35 K	739KJ4428779	1F66F5DY7J	35 K
739KJ4428385	1F66F5DY8J0	35 K	739KJ4428780	1F66F5DY5J	35 K
739PJ4428388	1F66F5DY7J0	35 P	739KJ4428781	1F66F5DY3J	35 K
739PJ4428389	1F66F5DY5J0	35 P	739PJ4428782	1F66F5DY9J	35 P
739PJ4428390	1F66F5DY3J0	35 P	739PJ4428783	1F66F5DY8J	35 P
739PJ4428391	1F66F5DYXJ0	35 P	739HJ4428793	1F66F5DY0J	36 H
739HJ4428394	1F66F5DYXJ0	36 H	739PJ4428796	1F66F5DY8J	35 P
739CJ4428450	1F66F5DY3J0	33 C	739CJ4428853	1F66F5DY4J	33 C
739PJ4428461	1F66F5DY3J0	35 P	739KJ4428870	1F66F5DY8J	35 K
739KJ4428462	1F66F5DY6J0	35 K	739PJ4428871	1F66F5DY4J	35 P
739KJ4428467	1F66F5DY8J0	35 K	739PJ4428872	1F66F5DY2J	35 P
739KJ4428468	1F66F5DYXJ0	35 K	739KJ4429063	1F66F5DY7J	35 K
739KJ4428469	1F66F5DY9J0	35 K	739PJ4429065	1F66F5DY7J	35 P
739KJ4428475	1F66F5DY9J0	35 K	739PJ4429095	1F66F5DY1J	35 P
739CJ4428476	1F66F5DY1J0	33 C	739CJ4429127	1F66F5DY9J	33 C
739KJ4428477	1F66F5DY8J0	35 K	739PJ4429130	1F66F5DY0J	35 P
739CJ4428532	1F66F5DY7J0	33 C	739KJ4429131	1F66F5DY1J	35 K
739PJ4428535	1F66F5DY8J0	35 P	739KJ4429196	1F66F5DY2J	35 K
739PJ4428543	1F66F5DY0J0	35 P	739PJ4429211	1F66F5DY0J	35 P
739PJ4428544	1F66F5DY3J0	35 P	739PJ4429213	1F66F5DYXJ	35 P
739PJ4428545	1F66F5DY3J0	35 P	739CJ4429214	1F66F5DY5J	33 C

Recall 191125REV
Affected Fleetwood Bounder Vehicles

Model Year 2018

UIN	CHASSIS VIN #	MODEL	UIN	CHASSIS VIN #	MODEL
739KJ4429216	1F66F5DY1J0	35 K	739KJ4429760	1F66F5DY4J	35 K
739CJ4429272	1F66F5DY0J0	33 C	739KJ4429806	1F66F5DY9J	35 K
739PJ4429273	1F66F5DY3J0	35 P	739KJ4429808	1F66F5DY5J	35 K
739PJ4429274	1F66F5DY6J0	35 P	739KJ4429809	1F66F5DY0J	35 K
739PJ4429276	1F66F5DY9J0	35 P	739KJ4429810	1F66F5DY1J	35 K
739KJ4429278	1F66F5DYXJ0	35 K	739KJ4429811	1F66F5DY0J	35 K
739KJ4429279	1F66F5DY8J0	35 K	739KJ4429812	1F66F5DYXJ	35 K
739KJ4429281	1F66F5DY6J0	35 K	739KJ4429869	1F66F5DY8J	35 K
739KJ4429282	1F66F5DY3J0	35 K	739KJ4429870	1F66F5DY2J	35 K
739KJ4429357	1F66F5DY4J0	35 K	739KJ4429871	1F66F5DY5J	35 K
739KJ4429359	1F66F5DY3J0	35 K	739KJ4429872	1F66F5DY7J	35 K
739PJ4429361	1F66F5DY1J0	35 P	739KJ4429873	1F66F5DY5J	35 K
739CJ4429373	1F66F5DY7J0	33 C	739KJ4429874	1F66F5DY9J	35 K
739KJ4429374	1F66F5DY0J0	35 K	739CJ4429879	1F66F5DY3J	33 C
739KJ4429420	1F66F5DY4J0	35 K	739CJ4429938	1F66F5DY9J	33 C
739KJ4429421	1F66F5DY2J0	35 K	739PJ4429948	1F66F5DY8J	35 P
739CJ4429427	1F66F5DY1J0	33 C	739PJ4429949	1F66F5DYXJ	35 P
739KJ4429429	1F66F5DY6J0	35 K	739KJ4429950	1F66F5DY5J	35 K
739PJ4429430	1F66F5DY7J0	35 P	739KJ4429954	1F66F5DY0J	35 K
739CJ4429487	1F66F5DY8J0	33 C	739KJ4429955	1F66F5DY2J	35 K
739CJ4429488	1F66F5DY2J0	33 C	739KJ4429956	1F66F5DY4J	35 K
739CJ4429489	1F66F5DY2J0	33 C	739KJ4429957	1F66F5DYXJ	35 K
739CJ4429490	1F66F5DY6J0	33 C	739PJ4429983	1F66F5DY8J	35 P
739PJ4429496	1F66F5DY5J0	35 P	739CJ4429987	1F66F5DY9J	33 C
739PJ4429497	1F66F5DY1J0	35 P	739CJ4429988	1F66F5DY8J	33 C
739KJ4429503	1F66F5DY4J0	35 K	739PJ4429989	1F66F5DYXJ	35 P
739PJ4429558	1F66F5DY4J0	35 P	739PJ4429990	1F66F5DY9J	35 P
739KJ4429565	1F66F5DY1J0	35 K	739KJ4429993	1F66F5DY5J	35 K
739KJ4429566	1F66F5DY3J0	35 K	739KJ4429994	1F66F5DYXJ	35 K
739KJ4429567	1F66F5DY3J0	35 K	739KJ4429995	1F66F5DY6J	35 K
739PJ4429577	1F66F5DY8J0	35 P	739KJ4429996	1F66F5DY1J	35 K
739CJ4429623	1F66F5DY7J0	33 C	739KJ4429997	1F66F5DY2J	35 K
739CJ4429624	1F66F5DY1J0	33 C	739KJ4429998	1F66F5DY9J	35 K
739PJ4429635	1F66F5DY6J0	35 P	739KJ4429999	1F66F5DY7J	35 K
739PJ4429636	1F66F5DYXJ0	35 P	739KJ4430000	1F66F5DY0J	35 K
739KJ4429640	1F66F5DY8J0	35 K	739KJ4430052	1F66F5DY1J	35 K
739KJ4429641	1F66F5DY9J0	35 K	739KJ4430053	1F66F5DY5J	35 K
739KJ4429642	1F66F5DYXJ0	35 K	739KJ4430054	1F66F5DY9J	35 K
739KJ4429679	1F66F5DY3J0	35 K	739KJ4430057	1F66F5DY3J	35 K
739KJ4429680	1F66F5DY0J0	35 K	739KJ4430058	1F66F5DY2J	35 K
739KJ4429694	1F66F5DY8J0	35 K	739CJ4430064	1F66F5DY0J	33 C
739KJ4429695	1F66F5DY2J0	35 K	739CJ4430065	1F66F5DY2J	33 C
739KJ4429696	1F66F5DY1J0	35 K	739PJ4430067	1F66F5DY7J	35 P
739KJ4429697	1F66F5DY8J0	35 K	739CJ4430121	1F66F5DY0J	33 C
739KJ4429698	1F66F5DY6J0	35 K	739PJ4430122	1F66F5DY0J	35 P
739KJ4429757	1F66F5DY5J0	35 K	739PJ4430123	1F66F5DY6J	35 P
739KJ4429758	1F66F5DY3J0	35 K	739KJ4430128	1F66F5DYXJ	35 K
739KJ4429759	1F66F5DY9J0	35 K	739KJ4430129	1F66F5DY1J	35 K

Recall 191125REV
Affected Fleetwood Bounder Vehicles

Model Year 2018

UIN	CHASSIS VIN #	MODEL
739KJ4430130	1F66F5DY7J0A [REDACTED]	35 K
739PJ4430131	1F66F5DY2J0 [REDACTED]	35 P
739PJ4430181	1F66F5DY6J0 [REDACTED]	35 P
739PJ4430182	1F66F5DY5J0 [REDACTED]	35 P
739KJ4430188	1F66F5DY4J0A [REDACTED]	35 K
739KJ4430189	1F66F5DY4J0 [REDACTED]	35 K

UIN	CHASSIS VIN #	MODEL
739PJ4430192	1F66F5DY9J0 [REDACTED]	35 P
739CJ4430198	1F66F5DY2J0 [REDACTED]	33 C
739CJ4430252	1F66F5DY9J0 [REDACTED]	33 C
739KJ4430330	1F66F5DY8J0 [REDACTED]	35 K
739KJ4430332	1F66F5DY9J0 [REDACTED]	35 K

Model Year 2019

UIN	CHASSIS VIN #	MODEL
739KK4429953	1F66F5DY9J [REDACTED]	35 K
739PK4430066	1F66F5DY1J [REDACTED]	35 P
739CK4430253	1F66F5DY1J [REDACTED]	33 C
739CK4430254	1F66F5DY4J [REDACTED]	33 C
739CK4430255	1F66F5DY1J [REDACTED]	33 C
739PK4430257	1F66F5DY7J [REDACTED]	35 P
739KK4430262	1F66F5DY8J [REDACTED]	35 K
739KK4430263	1F66F5DY1J [REDACTED]	35 K
739KK4430264	1F66F5DY0J [REDACTED]	35 K
739KK4430265	1F66F5DY4J [REDACTED]	35 K
739KK4430266	1F66F5DY0J [REDACTED]	35 K
739PK4430267	1F66F5DYXJ [REDACTED]	35 P
739PK4430315	1F66F5DYXJ [REDACTED]	35 P
739PK4430316	1F66F5DY8J [REDACTED]	35 P
739CK4430319	1F66F5DY3J [REDACTED]	33 C
739CK4430320	1F66F5DY6J [REDACTED]	33 C
739CK4430321	1F66F5DY2J [REDACTED]	33 C
739CK4430322	1F66F5DYXJ [REDACTED]	33 C
739PK4430323	1F66F5DY7J [REDACTED]	35 P
739KK4430329	1F66F5DY9J [REDACTED]	35 K
739KK4430331	1F66F5DY3J [REDACTED]	35 K
739CK4430380	1F66F5DY0J [REDACTED]	33 C
739CK4430381	1F66F5DY1J [REDACTED]	33 C
739KK4430388	1F66F5DY7J [REDACTED]	35 K
739KK4430389	1F66F5DY6J [REDACTED]	35 K
739PK4430398	1F66F5DY9J [REDACTED]	35 P
739PK4430399	1F66F5DY2J [REDACTED]	35 P
739CK4430454	1F66F5DY0J [REDACTED]	33 C
739CK4430455	1F66F5DY2J [REDACTED]	33 C
739PK4430457	1F66F5DY3J [REDACTED]	35 P
739PK4430458	1F66F5DY8J [REDACTED]	35 P
739KK4430459	1F66F5DY8J [REDACTED]	35 K
739KK4430460	1F66F5DY0J [REDACTED]	35 K
739KK4430461	1F66F5DY0J [REDACTED]	35 K
739KK4430462	1F66F5DY4J [REDACTED]	35 K
739PK4430463	1F66F5DYXJ [REDACTED]	35 P
739KK4430468	1F66F5DY2J [REDACTED]	35 K

UIN	CHASSIS VIN #	MODEL
739KK4430516	1F66F5DY6J [REDACTED]	35 K
739KK4430517	1F66F5DYXJ [REDACTED]	35 K
739KK4430518	1F66F5DY8J [REDACTED]	35 K
739KK4430519	1F66F5DYXJ [REDACTED]	35 K
739KK4430520	1F66F5DY4J [REDACTED]	35 K
739KK4430521	1F66F5DY2J [REDACTED]	35 K
739KK4430522	1F66F5DY8J [REDACTED]	35 K
739KK4430529	1F66F5DY1J [REDACTED]	35 K
739KK4430530	1F66F5DY1J [REDACTED]	35 K
739PK4430531	1F66F5DY3J [REDACTED]	35 P
739PK4430532	1F66F5DY5J [REDACTED]	35 P
739CK4430533	1F66F5DY8J [REDACTED]	33 C
739CK4430534	1F66F5DY3J [REDACTED]	33 C
739PK4430535	1F66F5DY7J [REDACTED]	35 P
739CK4430537	1F66F5DY7J [REDACTED]	33 C
739CK4430538	1F66F5DY2J [REDACTED]	33 C
739PK4430539	1F66F5DY7J [REDACTED]	35 P
739PK4430540	1F66F5DY3J [REDACTED]	35 P
739KK4430601	1F66F5DY6J [REDACTED]	35 K
739KK4430604	1F66F5DY1J [REDACTED]	35 K
739KK4430605	1F66F5DY5J [REDACTED]	35 K
739KK4430606	1F66F5DYXJ [REDACTED]	35 K
739KK4430607	1F66F5DY1J [REDACTED]	35 K
739KK4430608	1F66F5DY8J [REDACTED]	35 K
739PK4430609	1F66F5DY0J [REDACTED]	35 P
739CK4430610	1F66F5DY8J [REDACTED]	33 C
739CK4430611	1F66F5DY7J [REDACTED]	33 C
739PK4430612	1F66F5DY7J [REDACTED]	35 P
739PK4430615	1F66F5DY9J [REDACTED]	35 P
739KK4430660	1F66F5DY3J [REDACTED]	35 K
739CK4430663	1F66F5DY1J [REDACTED]	33 C
739CK4430664	1F66F5DY6J [REDACTED]	33 C
739PK4430673	1F66F5DY5J [REDACTED]	35 P
739PK4430674	1F66F5DY0J [REDACTED]	35 P
739KK4430675	1F66F5DY5J [REDACTED]	35 K
739KK4430676	1F66F5DY0J [REDACTED]	35 K
739PK4430677	1F66F5DY9J [REDACTED]	35 P

Recall 191125REV
Affected Fleetwood Bounder Vehicles

Model Year 2019

UIN	CHASSIS VIN #	MODEL	UIN	CHASSIS VIN #	MODEL
739KK4430679	1F66F5DY0JC	35 K	739CK4431034	1F66F5DY2J	33 C
739KK4430680	1F66F5DY3JC	35 K	739KK4431039	1F66F5DY4J	35 K
739KK4430683	1F66F5DY7JC	35 K	739KK4431040	1F66F5DYXJ	35 K
739KK4430684	1F66F5DY9JC	35 K	739KK4431043	1F66F5DY6J	35 K
739CK4430736	1F66F5DY5JC	33 C	739KK4431044	1F66F5DY8J	35 K
739CK4430737	1F66F5DY7JC	33 C	739CK4431046	1F66F5DY3J	33 C
739CK4430738	1F66F5DY4JC	33 C	739PK4431050	1F66F5DY2J	35 P
739PK4430746	1F66F5DY0JC	35 P	739CK4431102	1F66F5DYXJ	33 C
739KK4430747	1F66F5DYXJC	35 K	739KK4431105	1F66F5DY6J	35 K
739KK4430748	1F66F5DY3JC	35 K	739KK4431106	1F66F5DY9J	35 K
739KK4430749	1F66F5DY0JC	35 K	739KK4431107	1F66F5DY0J	35 K
739KK4430750	1F66F5DY2JC	35 K	739KK4431109	1F66F5DYXJ	35 K
739KK4430751	1F66F5DY6JC	35 K	739KK4431110	1F66F5DY5J	35 K
739KK4430752	1F66F5DY2JC	35 K	739PK4431112	1F66F5DY6J	35 P
739KK4430804	1F66F5DY1JC	35 K	739CK4431114	1F66F5DY8J	33 C
739KK4430805	1F66F5DY7JC	35 K	739KK4431115	1F66F5DYXJ	35 K
739PK4430806	1F66F5DY8JC	35 P	739PK4431117	1F66F5DY7J	35 P
739PK4430807	1F66F5DY3JC	35 P	739PK4431173	1F66F5DY1J	35 P
739KK4430815	1F66F5DY9JC	35 K	739CK4431180	1F66F5DYXJ	33 C
739KK4430816	1F66F5DY7JC	35 K	739PK4431186	1F66F5DY9J	35 P
739KK4430819	1F66F5DY6JC	35 K	739KK4431188	1F66F5DY2J	35 K
739KK4430820	1F66F5DY9JC	35 K	739KK4431189	1F66F5DY0J	35 K
739CK4430826	1F66F5DY8JC	33 C	739CK4431191	1F66F5DY3J	33 C
739CK4430827	1F66F5DY5JC	33 C	739CK4431240	1F66F5DY8J	33 C
739PK4430878	1F66F5DY1JC	35 P	739PK4431241	1F66F5DY8J	35 P
739CK4430879	1F66F5DY2JC	33 C	739KK4431242	1F66F5DY5J	35 K
739CK4430880	1F66F5DY5JC	33 C	739PK4431244	1F66F5DY0J	35 P
739PK4430886	1F66F5DYXJC	35 P	739KK4431246	1F66F5DY9J	35 K
739KK4430888	1F66F5DY9JC	35 K	739KK4431251	1F66F5DY1J	35 K
739KK4430889	1F66F5DY2JC	35 K	739KK4431302	1F66F5DY9J	35 K
739KK4430892	1F66F5DY8JC	35 K	739KK4431304	1F66F5DY9J	35 K
739KK4430893	1F66F5DY0JC	35 K	739CK4431305	1F66F5DY1J	33 C
739KK4430902	1F66F5DY6JC	35 K	739CK4431323	1F66F5DYXJ	33 C
739KK4430903	1F66F5DY8JC	35 K	739KK4431324	1F66F5DY3J	35 K
739CK4430956	1F66F5DY5JC	33 C	739PK4431326	1F66F5DY3J	35 P
739CK4430957	1F66F5DY6JC	33 C	739KK4431327	1F66F5DY1J	35 K
739PK4430960	1F66F5DY4JC	35 P	739KK4431382	1F66F5DYXJ	35 K
739KK4430963	1F66F5DYXJC	35 K	739CK4431385	1F66F5DY8J	33 C
739KK4430964	1F66F5DY8JC	35 K	739CK4431386	1F66F5DY0J	33 C
739PK4430965	1F66F5DY6JC	35 P	739KK4431388	1F66F5DY4J	35 K
739KK4430967	1F66F5DY9JC	35 K	739PK4431389	1F66F5DY8J	35 P
739KK4430968	1F66F5DYXJC	35 K	739KK4431391	1F66F5DY7J	35 K
739KK4430970	1F66F5DY1JC	35 K	739KK4431392	1F66F5DY9J	35 K
739PK4430971	1F66F5DYXJC	35 P	739PK4431396	1F66F5DY0J	35 P
739KK4430972	1F66F5DY3JC	35 K	739KK4431397	1F66F5DY5J	35 K
739KK4431030	1F66F5DY7JC	35 K	739KK4431398	1F66F5DY7J	35 K
739PK4431031	1F66F5DY6JC	35 P	739CK4431446	1F66F5DY5J	33 C
739KK4431033	1F66F5DY4JC	35 K	739CK4431452	1F66F5DY9J	33 C

Recall 191125REV
Affected Fleetwood Bounder Vehicles

Model Year 2019

UIN	CHASSIS VIN #	MODEL	UIN	CHASSIS VIN #	MODEL
739PK4431453	1F66F5DY4J	35 P	739CK4431843	1F66F5DY9	33 C
739KK4431459	1F66F5DY3J	35 K	739CK4431845	1F66F5DY1	33 C
739KK4431460	1F66F5DYXJ	35 K	739KK4431846	1F66F5DY9	35 K
739KK4431463	1F66F5DY5J	35 K	739KK4431848	1F66F5DY8	35 K
739KK4431464	1F66F5DY3J	35 K	739KK4431849	1F66F5DY7	35 K
739PK4431465	1F66F5DY9J	35 P	739KK4431851	1F66F5DY2	35 K
739CK4431509	1F66F5DY2J	33 C	739CK4431896	1F66F5DY8	33 C
739CK4431510	1F66F5DY4J	33 C	739KK4431897	1F66F5DYX	35 K
739KK4431512	1F66F5DY6J	35 K	739PK4431898	1F66F5DY6	35 P
739PK4431513	1F66F5DY1J	35 P	739KK4431901	1F66F5DY9	35 K
739CK4431515	1F66F5DY0J	33 C	739KK4431903	1F66F5DY3J	35 K
739CK4431516	1F66F5DY6J	33 C	739KK4431951	1F66F5DY7J	35 K
739KK4431518	1F66F5DY2J	35 K	739KK4431952	1F66F5DY4	35 K
739KK4431519	1F66F5DY6J	35 K	739KK4431954	1F66F5DYX	35 K
739PK4431520	1F66F5DY7J	35 P	739CK4431959	1F66F5DY8	33 C
739KK4431620	1F66F5DY7J	35 K	739PK4431960	1F66F5DY5	35 P
739KK4431622	1F66F5DY1J	35 K	739KK4431961	1F66F5DY1	35 K
739CK4431623	1F66F5DY4J	33 C	739CK4431963	1F66F5DY0	33 C
739KK4431625	1F66F5DY0J	35 K	739KK4431964	1F66F5DY6	35 K
739CK4431626	1F66F5DY2K	33 C	739CK4431997	1F66F5DY0	33 C
739KK4431663	1F66F5DY6J	35 K	739PK4431998	1F66F5DYX	35 P
739KK4431665	1F66F5DY5J	35 K	739CK4432001	1F66F5DY6	33 C
739KK4431666	1F66F5DYXJ	35 K	739KK4432003	1F66F5DY3	35 K
739CK4431669	1F66F5DYXK	33 C	739KK4432007	1F66F5DY7	35 K
739CK4431674	1F66F5DY2K	33 C	739CK4432046	1F66F5DY5	33 C
739KK4431675	1F66F5DY9J	35 K	739KK4432047	1F66F5DY2	35 K
739CK4431715	1F66F5DYXK	33 C	739KK4432049	1F66F5DY3	35 K
739PK4431716	1F66F5DY0K	35 P	739KK4432050	1F66F5DYX	35 K
739KK4431717	1F66F5DY1K	35 K	739CK4432052	1F66F5DY3	33 C
739CK4431722	1F66F5DY9K	33 C	739KK4432053	1F66F5DY3	35 K
739KK4431726	1F66F5DY0K	35 K	739PK4432057	1F66F5DYX	35 P
739KK4431727	1F66F5DYXK	35 K	739KK4432103	1F66F5DY8	35 K
739KK4431728	1F66F5DY7K	35 K	739CK4432105	1F66F5DY1	33 C
739CK4431729	1F66F5DYXK	33 C	739CK4432107	1F66F5DY2	33 C
739CK4431731	1F66F5DY9K	33 C	739KK4432110	1F66F5DY4	35 K
739CK4431732	1F66F5DY3K	33 C	739KK4432112	1F66F5DY4	35 K
739CK4431781	1F66F5DY1J	33 C	739KK4432113	1F66F5DYX	35 K
739CK4431782	1F66F5DY8J	33 C	739PK4432116	1F66F5DY5	35 P
739PK4431786	1F66F5DY9K	35 P	739CK4432157	1F66F5DY8	33 C
739CK4431787	1F66F5DY0K	33 C	739CK4432159	1F66F5DY1	33 C
739CK4431789	1F66F5DY3K	33 C	739KK4432161	1F66F5DY0	35 K
739CK4431790	1F66F5DY5K	33 C	739KK4432166	1F66F5DY2	35 K
739KK4431792	1F66F5DY7J	35 K	739KK4432168	1F66F5DY2	35 K
739KK4431794	1F66F5DY7J	35 K	739KK4432170	1F66F5DY6	35 K
739KK4431795	1F66F5DY5J	35 K	739PK4432172	1F66F5DY5	35 P
739KK4431796	1F66F5DYXJ	35 K	739CK4432210	1F66F5DY4	33 C
739KK4431797	1F66F5DY4J	35 K	739KK4432212	1F66F5DY1	35 K
739CK4431841	1F66F5DY6K	33 C	739CK4432214	1F66F5DY8	33 C

Recall 191125REV
Affected Fleetwood Bounder Vehicles

Model Year 2019

UIN	CHASSIS VIN #	MODEL	UIN	CHASSIS VIN #	MODEL
739PK4432218	1F66F5DY6K	35 P	739PK4432637	1F66F5DY2K	35 P
739CK4432219	1F66F5DY6K	33 C	739KK4432639	1F66F5DY8K	35 K
739PK4432245	1F66F5DY4K	35 P	739KK4432696	1F66F5DYXK	35 K
739KK4432246	1F66F5DY5K	35 K	739PK4432698	1F66F5DY0K	35 P
739KK4432248	1F66F5DY5K	35 K	739KK4432700	1F66F5DY3K	35 K
739KK4432252	1F66F5DY9K	35 K	739KK4432707	1F66F5DY4K	35 K
739CK4432256	1F66F5DY5K	33 C	739KK4432747	1F66F5DY2K	35 K
739CK4432258	1F66F5DY7K	33 C	739CK4432759	1F66F5DY9K	33 C
739CK4432291	1F66F5DY4K	33 C	739KK4432763	1F66F5DY1K	35 K
739PK4432294	1F66F5DY8K	35 P	739KK4432765	1F66F5DY5K	35 K
739CK4432300	1F66F5DY4K	33 C	739KK4432772	1F66F5DY5K	35 K
739KK4432305	1F66F5DY7K	35 K	739KK4432799	1F66F5DY4K	35 K
739KK4432311	1F66F5DY5J	35 K	739PK4432810	1F66F5DY4K	35 P
739KK4432320	1F66F5DY1K	35 K	739KK4432812	1F66F5DYXK	35 K
739KK4432321	1F66F5DY3K	35 K	739CK4432818	1F66F5DY6K	33 C
739CK4432370	1F66F5DY0K	33 C	739KK4432824	1F66F5DY7K	35 K
739PK4432372	1F66F5DY3K	35 P	739CK4432856	1F66F5DY9K	33 C
739CK4432396	1F66F5DY5K	33 C	739KK4432858	1F66F5DY6K	35 K
739KK4432399	1F66F5DY0K	35 K	739KK4432860	1F66F5DY3K	35 K
739KK4432402	1F66F5DY1K	35 K	739CK4432870	1F66F5DYXK	33 C
739PK4432404	1F66F5DY8K	35 P	739KK4432874	1F66F5DYXK	35 K
739CK4432405	1F66F5DY4K	33 C	739PK4432876	1F66F5DY6K	35 P
739KK4432412	1F66F5DY0K	35 K	739KK4432936	1F66F5DYXK	35 K
739KK4432420	1F66F5DY1K	35 K	739PK4432942	1F66F5DY9K	35 P
739PK4432422	1F66F5DY3K	35 P	739KK4432958	1F66F5DY1K	35 K
739PK4432430	1F66F5DY6K	35 P	739KK4432959	1F66F5DY5K	35 K
739KK4432465	1F66F5DYXK	35 K	739CK4432963	1F66F5DYXK	33 C
739PK4432467	1F66F5DY6K	35 P	739PK4432997	1F66F5DY0K	35 P
739CK4432485	1F66F5DY4K	33 C	739KK4433014	1F66F5DY4K	35 K
739KK4432486	1F66F5DY9K	35 K	739KK4433016	1F66F5DY9K	35 K
739KK4432511	1F66F5DY9K	35 K	739KK4433028	1F66F5DY8K	35 K
739KK4432516	1F66F5DY5K	35 K	739CK4433032	1F66F5DY3K	33 C
739CK4432531	1F66F5DY7K	33 C	739CK4433038	1F66F5DY8K	33 C
739KK4432539	1F66F5DY7K	35 K	739KK4433069	1F66F5DY8K	35 K
739KK4432545	1F66F5DY6K	35 K	739KK4433073	1F66F5DY9K	35 K
739KK4432547	1F66F5DY6K	35 K	739KK4433076	1F66F5DY5K	35 K
739KK4432551	1F66F5DY0K	35 K	739CK4433080	1F66F5DY4K	33 C
739CK4432621	1F66F5DY7K	33 C	739PK4433086	1F66F5DY8K	35 P
739KK4432625	1F66F5DY9K	35 K			

Recall 191125REV
Affected Fleetwood Bounder Vehicles

Model Year 2020

UIN	CHASSIS VIN #	MODEL	UIN	CHASSIS VIN #	MODEL
739CL4433125	1F66F5DY5K	33 C	739CL4433486	1F66F5DY2K	33 C
739KL4433128	1F66F5DY9K	35 K	739PL4433489	1F66F5DY3K	35 P
739PL4433137	1F66F5DY1K	35 P	739CL4433494	1F66F5DY8K	33 C
739KL4433140	1F66F5DY2K	35 K	739CL4433495	1F66F5DY6K	33 C
739KL4433200	1F66F5DY6K	35 K	739KL4433496	1F66F5DY8K	35 K
739PL4433203	1F66F5DY3K	35 P	739KL4433499	1F66F5DYXK	35 K
739KL4433209	1F66F5DY2K	35 K	739KL4433501	1F66F5DY3K	35 K
739CL4433215	1F66F5DY0K	33 C	739PL4433503	1F66F5DY9K	35 P
739CL4433217	1F66F5DY9K	33 C	739KL4433546	1F66F5DY7K	35 K
739KL4433230	1F66F5DY1K	35 K	739KL4433548	1F66F5DY0K	35 K
739KL4433233	1F66F5DY8K	35 K	739KL4433550	1F66F5DY1K	35 K
739CL4433236	1F66F5DY2K	33 C	739KL4433577	1F66F5DY3K	35 K
739KL4433242	1F66F5DY4K	35 K	739CL4433579	1F66F5DY8K	33 C
739KL4433252	1F66F5DY5K	35 K	739CL4433587	1F66F5DY3K	33 C
739CL4433287	1F66F5DY5K	33 C	739KL4433593	1F66F5DY1K	35 K
739KL4433290	1F66F5DY0K	35 K	739KL4433595	1F66F5DY5K	35 K
739PL4433299	1F66F5DY2K	35 P	739KL4433597	1F66F5DY8K	35 K
739KL4433302	1F66F5DY3K	35 K	739KL4433607	1F66F5DY3K	35 K
739KL4433308	1F66F5DY0K	35 K	739KL4433615	1F66F5DY7K	35 K
739KL4433312	1F66F5DY4K	35 K	739PL4433617	1F66F5DY5K	35 P
739CL4433328	1F66F5DY1K	33 C	739KL4433618	1F66F5DY5K	35 K
739KL4433330	1F66F5DY4K	35 K	739KL4433663	1F66F5DY8K	35 K
739CL4433334	1F66F5DY9K	33 C	739CL4433665	1F66F5DY6K	33 C
739KL4433336	1F66F5DY6K	35 K	739KL4433673	1F66F5DY4K	35 K
739KL4433340	1F66F5DY8K	35 K	739KL4433675	1F66F5DY0K	35 K
739CL4433381	1F66F5DYXK	33 C	739KL4433679	1F66F5DY0K	35 K
739CL4433385	1F66F5DY4K	33 C	739KL4433705	1F66F5DY0K	35 K
739KL4433387	1F66F5DY6K	35 K	739KL4433711	1F66F5DY4K	35 K
739PL4433391	1F66F5DY0K	35 P	739CL4433720	1F66F5DY8K	33 C
739KL4433393	1F66F5DY0K	35 K	739CL4433760	1F66F5DY2K	33 C
739KL4433397	1F66F5DY1K	35 K	739KL4433762	1F66F5DY5K	35 K
739KL4433401	1F66F5DY8K	35 K	739KL4433770	1F66F5DY4K	35 K
739CL4433460	1F66F5DY4K	33 C	739KL4433774	1F66F5DY7K	35 K
739CL4433462	1F66F5DYXK	33 C	739KL4433778	1F66F5DY2K	35 K
739PL4433464	1F66F5DY6K	35 P	739CL4433797	1F66F5DY2K	33 C
739KL4433468	1F66F5DY5K	35 K	739KL4433799	1F66F5DY9K	35 K
739KL4433474	1F66F5DYXK	35 K	739KL4433803	1F66F5DY1K	35 K
739KL4433480	1F66F5DY9K	35 K	739KL4433812	1F66F5DY4K	35 K
739KL4433483	1F66F5DY6K	35 K			

Recall 191125REV
Affected Fleetwood Southwind Vehicles

Model Year 2018

UIN	CHASSIS VIN #	MODEL
721HJ4427844	1F66F5DY3H0	37 H
721PJ4427850	1F66F5DY6H0	36 P
721CJ4427858	1F66F5DY2J0	34 C
721KJ4427866	1F66F5DY7J0	35 K
721CJ4427922	1F66F5DY7J0	34 C
721PJ4427927	1F66F5DY3H0	36 P
721HJ4427932	1F66F5DY0J0	37 H
721KJ4427936	1F66F5DY0J0	35 K
721KJ4428002	1F66F5DY2J0	35 K
721KJ4428003	1F66F5DY8J0	35 K
721HJ4428004	1F66F5DY3H0	37 H
721HJ4428005	1F66F5DY9H0	37 H
721PJ4428009	1F66F5DY8H0	36 P
721PJ4428012	1F66F5DY0H0	36 P
721KJ4428075	1F66F5DYXJ0	35 K
721KJ4428076	1F66F5DY4J0	35 K
721KJ4428077	1F66F5DY9J0	35 K
721PJ4428078	1F66F5DY8H0	36 P
721PJ4428082	1F66F5DY6H0	36 P
721CJ4428148	1F66F5DY8J0	34 C
721KJ4428149	1F66F5DY8J0	35 K
721HJ4428150	1F66F5DY0J0	37 H
721HJ4428151	1F66F5DY5J0	37 H
721KJ4428152	1F66F5DY9J0	35 K
721KJ4428153	1F66F5DY5J0	35 K
721KJ4428158	1F66F5DY8J0	35 K
721KJ4428159	1F66F5DY0J0	35 K
721KJ4428160	1F66F5DY6J0	35 K
721CJ4428223	1F66F5DY0J0	34 C
721KJ4428232	1F66F5DYXJ0	35 K
721KJ4428233	1F66F5DY4J0	35 K
721KJ4428392	1F66F5DY7J0	35 K
721KJ4428393	1F66F5DY8J0	35 K
721CJ4428452	1F66F5DY3J0	34 C
721CJ4428453	1F66F5DY3J0	34 C
721HJ4428456	1F66F5DY2J0	37 H
721PJ4428463	1F66F5DY5J0	36 P
721KJ4428470	1F66F5DYXJ0	35 K
721KJ4428471	1F66F5DY8J0	35 K
721KJ4428472	1F66F5DY8J0	35 K
721CJ4428530	1F66F5DY5J0	34 C
721CJ4428531	1F66F5DY3J0	34 C
721PJ4428534	1F66F5DY3J0	36 P
721KJ4428538	1F66F5DYXJ0	35 K
721KJ4428539	1F66F5DY2J0	35 K
721KJ4428540	1F66F5DY7J0	35 K
721KJ4428541	1F66F5DY5J0	35 K
721HJ4428542	1F66F5DY7J0	37 H

UIN	CHASSIS VIN #	MODEL
721KJ4428610	1F66F5DY4J	35 K
721KJ4428611	1F66F5DY5J	35 K
721KJ4428612	1F66F5DY4J	35 K
721KJ4428613	1F66F5DY6J	35 K
721KJ4428614	1F66F5DY2J	35 K
721KJ4428615	1F66F5DY2J	35 K
721CJ4428621	1F66F5DY6J	34 C
721CJ4428622	1F66F5DY7J	34 C
721PJ4428623	1F66F5DY1J	36 P
721HJ4428634	1F66F5DY3J	37 H
721CJ4428688	1F66F5DY1J	34 C
721PJ4428689	1F66F5DY7J	36 P
721KJ4428690	1F66F5DY1J	35 K
721KJ4428691	1F66F5DY7J	35 K
721HJ4428692	1F66F5DY3J	37 H
721KJ4428769	1F66F5DY0J	35 K
721KJ4428770	1F66F5DY9J	35 K
721KJ4428771	1F66F5DY8J	35 K
721KJ4428772	1F66F5DY4J	35 K
721KJ4428773	1F66F5DY2J	35 K
721PJ4428774	1F66F5DY5J	36 P
721CJ4428785	1F66F5DY9J	34 C
721CJ4428786	1F66F5DY4J	34 C
721HJ4428792	1F66F5DY3J	37 H
721CJ4428852	1F66F5DY2J	34 C
721PJ4428855	1F66F5DY5J	36 P
721PJ4428856	1F66F5DY5J	36 P
721KJ4428857	1F66F5DYXJ	35 K
721KJ4428858	1F66F5DYXJ	35 K
721KJ4428859	1F66F5DYXJ	35 K
721KJ4428860	1F66F5DY3J	35 K
721HJ4428867	1F66F5DY7J	37 H
721HJ4428868	1F66F5DY9J	37 H
721KJ4428869	1F66F5DYXJ	35 K
721CJ4428975	1F66F5DY5J	34 C
721PJ4428976	1F66F5DYXJ	36 P
721PJ4428977	1F66F5DYXJ	36 P
721KJ4428983	1F66F5DY8J	35 K
721KJ4428984	1F66F5DY9J	35 K
721KJ4428985	1F66F5DY2J	35 K
721KJ4428986	1F66F5DY4J	35 K
721HJ4428987	1F66F5DY2J	37 H
721HJ4428988	1F66F5DY0J	37 H
721KJ4429051	1F66F5DY9J	35 K
721CJ4429053	1F66F5DY7J	34 C
721PJ4429054	1F66F5DYXJ	36 P
721PJ4429055	1F66F5DY1J	36 P
721KJ4429056	1F66F5DY3J	35 K

Recall 191125REV
Affected Fleetwood Southwind Vehicles

Model Year 2018

UIN	CHASSIS VIN #	MODEL
721KJ4429057	1F66F5DY0J	35 K
721KJ4429059	1F66F5DY2J	35 K
721HJ4429061	1F66F5DY0J	37 H
721HJ4429062	1F66F5DY5J	37 H
721PJ4429118	1F66F5DY1J	36 P
721PJ4429119	1F66F5DY3J	36 P
721CJ4429120	1F66F5DY2J	34 C
721CJ4429121	1F66F5DY0J	34 C
721KJ4429122	1F66F5DY7J	35 K
721KJ4429123	1F66F5DY8J	35 K
721HJ4429124	1F66F5DY9J	37 H
721HJ4429126	1F66F5DY7J	37 H
721KJ4429195	1F66F5DY4J	35 K
721KJ4429200	1F66F5DY1J	35 K
721PJ4429203	1F66F5DY4J	36 P
721PJ4429206	1F66F5DY7J	36 P
721HJ4429209	1F66F5DY5J	37 H
721KJ4429267	1F66F5DY6J	35 K
721KJ4429268	1F66F5DY4J	35 K
721KJ4429269	1F66F5DY6J	35 K
721KJ4429270	1F66F5DY4J	35 K
721HJ4429370	1F66F5DY7J	37 H
721CJ4429372	1F66F5DY4J	34 C
721KJ4429418	1F66F5DY5J	35 K
721KJ4429419	1F66F5DY5J	35 K
721CJ4429486	1F66F5DY0J	34 C
721KJ4429504	1F66F5DY9J	35 K
721PJ4429556	1F66F5DY7J	36 P
721PJ4429557	1F66F5DY1J	36 P
721CJ4429582	1F66F5DY5J	34 C
721PJ4429628	1F66F5DY0J	36 P
721CJ4429648	1F66F5DY3J	34 C
721PJ4429685	1F66F5DY6J	36 P
721PJ4429686	1F66F5DY3J	36 P
721PJ4429699	1F66F5DY5J	36 P
721PJ4429700	1F66F5DY4J	36 P
721KJ4429744	1F66F5DY3J	35 K

UIN	CHASSIS VIN #	MODEL
721PJ4429745	1F66F5DY7J	36 P
721HJ4429798	1F66F5DY0J	37 H
721KJ4429816	1F66F5DY1J	35 K
721KJ4429877	1F66F5DY4J	35 K
721KJ4429878	1F66F5DY6J	35 K
721PJ4429937	1F66F5DY6J	36 P
721KJ4429945	1F66F5DYXJ	35 K
721KJ4429946	1F66F5DY9J	35 K
721KJ4429947	1F66F5DY0J	35 K
721KJ4429984	1F66F5DY7J	35 K
721HJ4430006	1F66F5DY7J	37 H
721PJ4430047	1F66F5DY4J	36 P
721HJ4430048	1F66F5DY7J	37 H
721KJ4430050	1F66F5DY0J	35 K
721KJ4430051	1F66F5DY2J	35 K
721CJ4430062	1F66F5DY1J	34 C
721CJ4430063	1F66F5DY4J	34 C
721CJ4430119	1F66F5DY0J	34 C
721CJ4430120	1F66F5DY6J	34 C
721KJ4430124	1F66F5DY6J	35 K
721KJ4430125	1F66F5DY9J	35 K
721PJ4430126	1F66F5DY9J	36 P
721KJ4430190	1F66F5DY3J	35 K
721KJ4430191	1F66F5DY7J	35 K
721HJ4430194	1F66F5DYXJ	37 H
721HJ4430195	1F66F5DY8J	37 H
721KJ4430196	1F66F5DY2J	35 K
721CJ4430197	1F66F5DY4J	34 C
721PJ4430243	1F66F5DY5J	36 P
721PJ4430244	1F66F5DY8J	36 P
721HJ4430245	1F66F5DY9J	37 H
721HJ4430246	1F66F5DY9J	37 H
721KJ4430247	1F66F5DY9J	35 K
721KJ4430248	1F66F5DY7J	35 K
721KJ4430249	1F66F5DY7J	35 K
721KJ4430327	1F66F5DY7J	35 K

Recall 191125REV
Affected Fleetwood Southwind Vehicles

Model Year 2019

UIN	CHASSIS VIN #	MODEL	UIN	CHASSIS VIN #	MODEL
721HK4430005	1F66F5DY5J0	37 H	721KK4430667	1F66F5DYXJ	35 K
721PK4430256	1F66F5DY8J0	36 P	721KK4430669	1F66F5DY2J	35 K
721PK4430310	1F66F5DY0J0	36 P	721PK4430685	1F66F5DY4J	36 P
721PK4430311	1F66F5DY1J0	36 P	721PK4430686	1F66F5DY9J	36 P
721HK4430312	1F66F5DY8J0	37 H	721KK4430687	1F66F5DY1J	35 K
721HK4430313	1F66F5DY6J0	37 H	721CK4430734	1F66F5DY5J	34 C
721HK4430314	1F66F5DY4J0	37 H	721CK4430735	1F66F5DY3J	34 C
721CK4430317	1F66F5DYXJ0	34 C	721KK4430742	1F66F5DY5J	35 K
721CK4430318	1F66F5DY3J0	34 C	721KK4430743	1F66F5DY6J	35 K
721KK4430326	1F66F5DY3J0	35 K	721KK4430744	1F66F5DY8J	35 K
721KK4430328	1F66F5DY3J0	35 K	721PK4430745	1F66F5DY2J	36 P
721PK4430378	1F66F5DY1J0	36 P	721PK4430811	1F66F5DY2J	36 P
721PK4430379	1F66F5DY2J0	36 P	721KK4430812	1F66F5DY8J	35 K
721KK4430384	1F66F5DY0J0	35 K	721KK4430813	1F66F5DY5J	35 K
721KK4430385	1F66F5DY2J0	35 K	721PK4430821	1F66F5DY0J	36 P
721KK4430386	1F66F5DY1J0	35 K	721CK4430824	1F66F5DY3J	34 C
721KK4430387	1F66F5DY4J0	35 K	721CK4430875	1F66F5DY1J	34 C
721KK4430396	1F66F5DY5J0	35 K	721CK4430876	1F66F5DY8J	34 C
721KK4430397	1F66F5DY2J0	35 K	721PK4430877	1F66F5DY0J	36 P
721KK4430400	1F66F5DYXJ0	35 K	721KK4430898	1F66F5DY2J	35 K
721KK4430401	1F66F5DY4J0	35 K	721KK4430899	1F66F5DY6J	35 K
721KK4430403	1F66F5DY6J0	35 K	721CK4430949	1F66F5DY7J	34 C
721CK4430444	1F66F5DY7J0	34 C	721PK4430950	1F66F5DY4J	36 P
721PK4430445	1F66F5DY3J0	36 P	721CK4430951	1F66F5DY9J	34 C
721PK4430446	1F66F5DY9J0	36 P	721KK4430952	1F66F5DY1J	35 K
721KK4430447	1F66F5DY5J0	35 K	721PK4430955	1F66F5DY8J	36 P
721KK4430448	1F66F5DY2J0	35 K	721KK4430959	1F66F5DY3J	35 K
721KK4430449	1F66F5DY7J0	35 K	721KK4430961	1F66F5DY5J	35 K
721KK4430450	1F66F5DY3J0	35 K	721PK4431022	1F66F5DY6J	36 P
721PK4430523	1F66F5DY5J0	36 P	721KK4431023	1F66F5DY1J	35 K
721PK4430524	1F66F5DYXJ0	36 P	721KK4431024	1F66F5DY0J	35 K
721KK4430525	1F66F5DY7J0	35 K	721CK4431026	1F66F5DY1J	34 C
721KK4430526	1F66F5DY8J0	35 K	721KK4431027	1F66F5DY1J	35 K
721CK4430541	1F66F5DY6J0	34 C	721PK4431097	1F66F5DY4J	36 P
721CK4430542	1F66F5DY1J0	34 C	721KK4431098	1F66F5DY5J	35 K
721KK4430588	1F66F5DY0J0	35 K	721KK4431099	1F66F5DY7J	35 K
721KK4430589	1F66F5DYXJ0	35 K	721KK4431101	1F66F5DY8J	35 K
721KK4430590	1F66F5DY6J0	35 K	721PK4431104	1F66F5DYXJ	36 P
721CK4430591	1F66F5DYXJ0	34 C	721CK4431120	1F66F5DY8J	34 C
721CK4430592	1F66F5DYXJ0	34 C	721PK4431174	1F66F5DYXJ	36 P
721PK4430593	1F66F5DY8J0	36 P	721KK4431175	1F66F5DY0J	35 K
721PK4430594	1F66F5DY2J0	36 P	721KK4431176	1F66F5DY1J	35 K
721KK4430595	1F66F5DY1J0	35 K	721PK4431178	1F66F5DY8J	36 P
721KK4430596	1F66F5DY5J0	35 K	721KK4431182	1F66F5DY3J	35 K
721KK4430597	1F66F5DY3J0	35 K	721CK4431183	1F66F5DY4J	34 C
721KK4430603	1F66F5DY7J0	35 K	721CK4431232	1F66F5DY6J	34 C
721CK4430661	1F66F5DYXJ0	34 C	721KK4431233	1F66F5DY4J	35 K
721CK4430662	1F66F5DYXJ0	34 C	721PK4431234	1F66F5DY5J	36 P

Recall 191125REV
Affected Fleetwood Southwind Vehicles

Model Year 2019

UIN	CHASSIS VIN #	MODEL	UIN	CHASSIS VIN #	MODEL
721KK4431235	1F66F5DY4J0	35 K	721CK4431990	1F66F5DY7K0	34 C
721KK4431237	1F66F5DY3J0	35 K	721CK4431992	1F66F5DY1K0	34 C
721CK4431292	1F66F5DY6J0	34 C	721PK4431993	1F66F5DY1K0	36 P
721PK4431293	1F66F5DY2J0	36 P	721KK4431994	1F66F5DY7K0	35 K
721KK4431294	1F66F5DY0J0	35 K	721KK4431995	1F66F5DYXK0	35 K
721KK4431295	1F66F5DY2J0	35 K	721KK4432042	1F66F5DY1K0	35 K
721KK4431297	1F66F5DY4J0	35 K	721CK4432044	1F66F5DY5K0	34 C
721KK4431298	1F66F5DY0J0	35 K	721CK4432098	1F66F5DY6K0	34 C
721CK4431320	1F66F5DY9J0	34 C	721KK4432100	1F66F5DY8K0	35 K
721PK4431321	1F66F5DYXJ0	36 P	721CK4432102	1F66F5DYXK0	34 C
721KK4431322	1F66F5DY5J0	35 K	721PK4432108	1F66F5DY3K0	36 P
721CK4431377	1F66F5DY2J0	34 C	721CK4432156	1F66F5DY2K0	34 C
721KK4431378	1F66F5DY6J0	35 K	721PK4432158	1F66F5DY6K0	36 P
721KK4431379	1F66F5DY2J0	35 K	721PK4432163	1F66F5DY8K0	36 P
721PK4431380	1F66F5DY1J0	36 P	721PK4432167	1F66F5DY1K0	36 P
721CK4431383	1F66F5DY7J0	34 C	721KK4432220	1F66F5DY3K0	35 K
721CK4431443	1F66F5DY9J0	34 C	721CK4432223	1F66F5DY6K0	34 C
721CK4431444	1F66F5DY7J0	34 C	721PK4432224	1F66F5DY0K0	36 P
721PK4431447	1F66F5DY5J0	36 P	721KK4432242	1F66F5DYXK0	35 K
721KK4431449	1F66F5DY7J0	35 K	721CK4432244	1F66F5DY0K0	34 C
721KK4431450	1F66F5DY0J0	35 K	721CK4432250	1F66F5DY1K0	34 C
721PK4431461	1F66F5DY3J0	36 P	721KK4432296	1F66F5DY9K0	35 K
721KK4431618	1F66F5DY5J0	35 K	721PK4432298	1F66F5DY0K0	36 P
721PK4431619	1F66F5DY5J0	36 P	721PK4432313	1F66F5DY6K0	36 P
721CK4431658	1F66F5DY2J0	34 C	721KK4432323	1F66F5DY3K0	35 K
721KK4431661	1F66F5DY0K0	35 K	721PK4432351	1F66F5DY4K0	36 P
721KK4431671	1F66F5DY4J0	35 K	721CK4432354	1F66F5DYXK0	34 C
721KK4431723	1F66F5DY1K0	35 K	721KK4432358	1F66F5DY4K0	35 K
721KK4431723	1F66F5DY1K0	35 K	721KK4432393	1F66F5DY9K0	35 K
721KK4431724	1F66F5DY9K0	35 K	721PK4432395	1F66F5DY7K0	36 P
721CK4431733	1F66F5DY6K0	34 C	721KK4432408	1F66F5DY3K0	35 K
721KK4431779	1F66F5DY4J0	35 K	721PK4432414	1F66F5DY2K0	36 P
721CK4431784	1F66F5DY3K0	34 C	721KK4432457	1F66F5DY6K0	35 K
721KK4431785	1F66F5DY7J0	35 K	721CK4432461	1F66F5DY2K0	34 C
721CK4431791	1F66F5DY2K0	34 C	721PK4432525	1F66F5DY8K0	36 P
721CK4431835	1F66F5DY8K0	34 C	721PK4432619	1F66F5DY4K0	36 P
721CK4431837	1F66F5DY8K0	34 C	721KK4432635	1F66F5DY9K0	35 K
721KK4431838	1F66F5DY2J0	35 K	721KK4432690	1F66F5DY0K0	35 K
721KK4431840	1F66F5DY0J0	35 K	721KK4432694	1F66F5DY1K0	35 K
721CK4431891	1F66F5DY7K0	34 C	721CK4432705	1F66F5DY2K0	34 C
721KK4431892	1F66F5DY1J0	35 K	721PK4432714	1F66F5DY2K0	36 P
721KK4431894	1F66F5DY0J0	35 K	721CK4432716	1F66F5DY1K0	34 C
721CK4431900	1F66F5DY7K0	34 C	721CK4432751	1F66F5DY7K0	34 C
721CK4431948	1F66F5DY1K0	34 C	721KK4432755	1F66F5DY6K0	35 K
721CK4431949	1F66F5DY2K0	34 C	721CK4432803	1F66F5DY2K0	34 C
721PK4431953	1F66F5DY1K0	36 P	721PK4432804	1F66F5DY3K0	36 P
721KK4431956	1F66F5DY9K0	35 K	721KK4432808	1F66F5DY7K0	35 K
721KK4431957	1F66F5DY9K0	35 K	721KK4432814	1F66F5DY6K0	35 K

Recall 191125REV
Affected Fleetwood Southwind Vehicles

Model Year 2019

UIN	CHASSIS VIN #	MODEL
721KK4432864	1F66F5DY7K0 [REDACTED]	35 K
721PK4432866	1F66F5DY5K0 [REDACTED]	36 P
721CK4432868	1F66F5DY3K0 [REDACTED]	34 C
721KK4432940	1F66F5DY8K0 [REDACTED]	35 K
721CK4432944	1F66F5DY1K0 [REDACTED]	34 C
721KK4432950	1F66F5DY6K0 [REDACTED]	35 K
721PK4432954	1F66F5DY5K0 [REDACTED]	36 P
721CK4432956	1F66F5DY5K0 [REDACTED]	34 C

UIN	CHASSIS VIN #	MODEL
721PK4432994	1F66F5DY3K0 [REDACTED]	36 P
721CK4433026	1F66F5DY8K0 [REDACTED]	34 C
721CK4433030	1F66F5DY7K0 [REDACTED]	34 C
721KK4433034	1F66F5DYXK0 [REDACTED]	35 K
721KK4433036	1F66F5DYXK0 [REDACTED]	35 K
721CK4433071	1F66F5DY8K0 [REDACTED]	34 C
721KK4433082	1F66F5DY7K0 [REDACTED]	35 K

Model Year 2020

UIN	CHASSIS VIN #	MODEL
721KL4433322	1F66F5DY3K0 [REDACTED]	35 K
721KL4433379	1F66F5DY6K0 [REDACTED]	35 K
721CL4433456	1F66F5DYXK0 [REDACTED]	34 C
721KL4433585	1F66F5DY5K0 [REDACTED]	35 K

UIN	CHASSIS VIN #	MODEL
721KL4433609	1F66F5DY0 [REDACTED]	35 K
721KL4433715	1F66F5DY7K0 [REDACTED]	35 K
721PL4433717	1F66F5DY2K0 [REDACTED]	36 P

**Recall 191125REV Affected Unit Serial Numbers -
Holiday Rambler Vacationer**

Model Year 2016

UIN	CHASSIS VIN #	MODEL
623SG4421184	1F66F5DY7F0	34 ST
623SG4421537	1F66F5DY3F0	34 ST
623SG4421542	1F66F5DY8F0	34 ST
623SG4421546	1F66F5DY0G0	34 ST
623SG4421584	1F66F5DY5F0	34 ST
623SG4421586	1F66F5DY2F0	34 ST
623SG4421592	1F66F5DY9F0	34 ST
623SG4421638	1F66F5DY7F0	34 ST
623SG4421641	1F66F5DY5F0	34 ST
623SG4421646	1F66F5DY2F0	34 ST
623SG4421648	1F66F5DY8F0	34 ST
623SG4421651	1F66F5DY2F0	34 ST
623SG4421798	1F66F5DY7G0	34 ST
623DG4421926	1F66F5DY3G0	35 DK
623BG4421979	1F66F5DYXG0	37 BH
623CG4422019	1F66F5DYXG0	33 CT
623DG4422084	1F66F5DY3G0	35 DK
623SG4422119	1F66F5DY4G0	34 ST
623BG4422124	1F66F5DY5G0	37 BH
623DG4422131	1F66F5DY7G0	35 DK
623DG4422172	1F66F5DY0G0	35 DK
623BG4422178	1F66F5DY6G0	37 BH
623CG4422181	1F66F5DY4G0	33 CT
623CG4422201	1F66F5DY4G0	33 CT
623BG4422211	1F66F5DY3G0	37 BH
623DG4422218	1F66F5DY1G0	35 DK
623DG4422220	1F66F5DY9G0	35 DK
623DG4422257	1F66F5DY7G0	35 DK
623DG4422262	1F66F5DY2G0	35 DK
623DG4422271	1F66F5DY6G0	35 DK
623DG4422314	1F66F5DY9G0	35 DK
623CG4422325	1F66F5DY8G0	33 CT
623BG4422333	1F66F5DY2G0	37 BH
623DG4422338	1F66F5DY2G0	35 DK
623SG4422375	1F66F5DY9G0	34 ST
623DG4422380	1F66F5DY5G0	35 DK
623BG4422383	1F66F5DYXG0	37 BH
623CG4422391	1F66F5DY1G0	33 CT
623DG4422421	1F66F5DY2G0	35 DK
623DG4422424	1F66F5DY9G0	35 DK
623CG4422427	1F66F5DY5G0	33 CT
623DG4422437	1F66F5DY7G0	35 DK
623CG4422443	1F66F5DY1G0	33 CT
623DG4422483	1F66F5DY1G0	35 DK
623DG4422494	1F66F5DY7G0	35 DK
623BG4422500	1F66F5DY8G0	37 BH
623CG4422505	1F66F5DY6G0	33 CT
623DG4422510	1F66F5DY0G0	35 DK

UIN	CHASSIS VIN #	MODEL
623DG4422560	1F66F5DY9G0	35 DK
623CG4422565	1F66F5DY8G0	33 CT
623DG4422569	1F66F5DY2G0	35 DK
623SG4422574	1F66F5DY7G0	34 ST
623SG4422626	1F66F5DY9G0	34 ST
623CG4422635	1F66F5DY2G0	33 CT
623DG4422639	1F66F5DY5G0	35 DK
623BG4422644	1F66F5DY1G0	37 BH
623DG4422687	1F66F5DY6G0	35 DK
623SG4422692	1F66F5DY6G0	34 ST
623DG4422697	1F66F5DY8G0	35 DK
623BG4422701	1F66F5DY2G0	37 BH
623DG4422707	1F66F5DY1G0	35 DK
623CG4422709	1F66F5DYXG0	33 CT
623BG4422771	1F66F5DY2G0	37 BH
623SG4422781	1F66F5DY7G0	34 ST
623DG4422784	1F66F5DY4G0	35 DK
623CG4422795	1F66F5DYXG0	33 CT
623DG4422798	1F66F5DY6G0	35 DK
623DG4422822	1F66F5DY2G0	35 DK
623DG4422824	1F66F5DY9G0	35 DK
623DG4422830	1F66F5DY2G0	35 DK
623BG4422837	1F66F5DY4G0	37 BH
623CG4422845	1F66F5DY1G0	33 CT
623CG4422850	1F66F5DY7G0	33 CT
623DG4422854	1F66F5DY6G0	35 DK
623DG4422907	1F66F5DY7G0	35 DK
623DG4422910	1F66F5DY3G0	35 DK
623DG4422911	1F66F5DY0G0	35 DK
623CG4422912	1F66F5DYXG0	33 CT
623CG4422914	1F66F5DY0G0	33 CT
623SG4422915	1F66F5DY4G0	34 ST
623BG4422916	1F66F5DY4G0	37 BH
623CG4422918	1F66F5DY8G0	33 CT
623BG4422919	1F66F5DY6G0	37 BH
623DG4422996	1F66F5DY5G0	35 DK
623SG4422997	1F66F5DY8G0	34 ST
623SG4423005	1F66F5DY6G0	34 ST
623DG4423008	1F66F5DY9G0	35 DK
623DG4423009	1F66F5DY7G0	35 DK
623CG4423012	1F66F5DY3G0	33 CT
623CG4423013	1F66F5DY6G0	33 CT
623CG4423016	1F66F5DY0G0	33 CT
623BG4423017	1F66F5DY3G0	37 BH
623DG4423036	1F66F5DY8G0	35 DK
623BG4423053	1F66F5DY3G0	37 BH
623SG4423056	1F66F5DY9G0	34 ST
623DG4423058	1F66F5DY1G0	35 DK

**Recall 191125REV Affected Unit Serial Numbers -
Holiday Rambler Vacationer**

Model Year 2016

UIN	CHASSIS VIN #	MODEL
623DG4423059	1F66F5DY7G0	35 DK
623SG4423109	1F66F5DY7G0	34 ST
623CG4423110	1F66F5DY4G0	33 CT
623DG4423112	1F66F5DY0G0	35 DK
623DG4423113	1F66F5DY0G0	35 DK
623DG4423114	1F66F5DY9G0A	35 DK
623DG4423156	1F66F5DY0G0	35 DK

UIN	CHASSIS VIN #	MODEL
623DG4423160	1F66F5DY2G0	35 DK
623BG4423163	1F66F5DY8G0	37 BH
623DG4423169	1F66F5DY6G0	35 DK
623CG4423171	1F66F5DY8G0	33 CT
623CG4423179	1F66F5DY1G0	33 CT
623DG4423182	1F66F5DY0G0	35 DK
623BG4423183	1F66F5DY1G0	37 BH

Model Year 2017

UIN	CHASSIS VIN #	MODEL
623XH4422764	1F66F5DY7G	36 X
623CH4423267	1F66F5DY9G	33 C
623XH4423271	1F66F5DY0G	36 X
623CH4423275	1F66F5DY2G	33 C
623KH4423278	1F66F5DY7G	35 K
623YH4423279	1F66F5DY9G	36 Y
623KH4423280	1F66F5DY5G	35 K
623HH4423285	1F66F5DY6G	36 H
623HH4423304	1F66F5DY3G	36 H
623CH4423307	1F66F5DY1G	33 C
623XH4423312	1F66F5DY9G	36 X
623CH4423314	1F66F5DY1G	33 C
623KH4423319	1F66F5DY6G	35 K
623KH4423324	1F66F5DYXG	35 K
623CH4423330	1F66F5DYXG	33 C
623CH4423337	1F66F5DY2G	33 C
623YH4423340	1F66F5DY3G	36 Y
623HH4423370	1F66F5DY8G	36 H
623XH4423374	1F66F5DY7G	36 X
623XH4423377	1F66F5DYXG	36 X
623CH4423380	1F66F5DY4G	33 C
623KH4423385	1F66F5DY9G	35 K
623YH4423387	1F66F5DY0G	36 Y
623YH4423391	1F66F5DY9G	36 Y
623KH4423392	1F66F5DY0G	35 K
623KH4423437	1F66F5DY3G	35 K
623KH4423443	1F66F5DY6G	35 K
623KH4423444	1F66F5DY5G	35 K
623KH4423449	1F66F5DY4G	35 K
623KH4423452	1F66F5DY2G	35 K
623KH4423454	1F66F5DY8G	35 K
623CH4423462	1F66F5DY8G	33 C
623YH4423463	1F66F5DY6G	36 Y
623CH4423464	1F66F5DY9G	33 C

UIN	CHASSIS VIN #	MODEL
623CH4423466	1F66F5DY2G	33 C
623YH4423467	1F66F5DY4G	36 Y
623YH4423509	1F66F5DY0G	36 Y
623KH4423513	1F66F5DY9G	35 K
623KH4423518	1F66F5DY8G	35 K
623YH4423520	1F66F5DY9G	36 Y
623CH4423530	1F66F5DY1G	33 C
623HH4423533	1F66F5DY1G	36 H
623HH4423535	1F66F5DY1G	36 H
623KH4423537	1F66F5DY1G	35 K
623KH4423568	1F66F5DYXG	35 K
623HH4423570	1F66F5DY5G	36 H
623KH4423575	1F66F5DY8G	35 K
623KH4423580	1F66F5DY9G	35 K
623CH4423585	1F66F5DY6G	33 C
623KH4423591	1F66F5DY9G	35 K
623KH4423661	1F66F5DY3G	35 K
623XH4423668	1F66F5DY3G	36 X
623HH4423671	1F66F5DYXG	36 H
623YH4423684	1F66F5DY6G	36 Y
623HH4423690	1F66F5DY6G	36 H
623CH4423691	1F66F5DY7G	33 C
623HH4423696	1F66F5DY1G	36 H
623KH4423759	1F66F5DY4G	35 K
623HH4423760	1F66F5DY7G	36 H
623TH4423765	1F66F5DY0G	34 T
623YH4423770	1F66F5DY2G	36 Y
623CH4423774	1F66F5DY0G	33 C
623YH4423775	1F66F5DY5G	36 Y
623HH4423778	1F66F5DY3G	36 H
623KH4423780	1F66F5DY7G	35 K
623TH4423782	1F66F5DY1G	34 T
623CH4423792	1F66F5DY3G	33 C
623HH4423811	1F66F5DY7G	36 H

**Recall 191125REV Affected Unit Serial Numbers -
Holiday Rambler Vacationer**

Model Year 2017

UIN	CHASSIS VIN #	MODEL	UIN	CHASSIS VIN #	MODEL
623KH4423872	1F66F5DY6G0	35 K	623HH4424713	1F66F5DY3H0	36 H
623KH4423877	1F66F5DY0G0	35 K	623HH4424743	1F66F5DY6H0	36 H
623HH4423882	1F66F5DYXG	36 H	623HH4424749	1F66F5DY8H0	36 H
623XH4423886	1F66F5DY3G0	36 X	623XH4424760	1F66F5DY8G0	36 X
623YH4423900	1F66F5DY8G0	36 Y	623TH4424768	1F66F5DY5H0	34 T
623CH4423948	1F66F5DY5G0	33 C	623YH4424831	1F66F5DY7G0	36 Y
623KH4423952	1F66F5DY0G0	35 K	623CH4424842	1F66F5DY7H0	33 C
623HH4423956	1F66F5DY2G0	36 H	623CH4424885	1F66F5DY5H0	33 C
623KH4423959	1F66F5DY8G0	35 K	623HH4424886	1F66F5DY0H0	36 H
623HH4423967	1F66F5DY4G0	36 H	623HH4424894	1F66F5DY5H0	36 H
623HH4423974	1F66F5DY6G0	36 H	623KH4424898	1F66F5DY3H0	35 K
623KH4424076	1F66F5DY2G0	35 K	623KH4424901	1F66F5DY3H0	35 K
623KH4424084	1F66F5DY2G0	35 K	623HH4424902	1F66F5DYXH0	36 H
623HH4424085	1F66F5DY8G0	36 H	623KH4424906	1F66F5DY9H0	35 K
623XH4424091	1F66F5DY2G0	36 X	623KH4424907	1F66F5DY5H0	35 K
623TH4424119	1F66F5DY6H0	34 T	623HH4424910	1F66F5DY1H0	36 H
623KH4424132	1F66F5DY7H0	35 K	623HH4424962	1F66F5DY7H0	36 H
623CH4424185	1F66F5DY9H0	33 C	623KH4424963	1F66F5DY6H0	35 K
623CH4424190	1F66F5DY8H0	33 C	623KH4424965	1F66F5DY6H0	35 K
623YH4424195	1F66F5DY5G0	36 Y	623HH4424968	1F66F5DY3H0	36 H
623YH4424197	1F66F5DY9G0	36 Y	623KH4425007	1F66F5DY0H0	35 K
623YH4424205	1F66F5DY0G0	36 Y	623KH4425061	1F66F5DY1H0	35 K
623YH4424209	1F66F5DY1G0	36 Y	623KH4425069	1F66F5DY8H0	35 K
623HH4424225	1F66F5DY2H0	36 H	623HH4425071	1F66F5DY2H0	36 H
623XH4424229	1F66F5DY0G0	36 X	623CH4425076	1F66F5DY8H0	33 C
623YH4424239	1F66F5DY6G0	36 Y	623KH4425134	1F66F5DY2H0	35 K
623YH4424299	1F66F5DY9G0	36 Y	623KH4425143	1F66F5DYXH0	35 K
623HH4424306	1F66F5DY9H0	36 H	623HH4425144	1F66F5DY4H0	36 H
623KH4424354	1F66F5DY0H0	35 K	623CH4425149	1F66F5DY2H0	33 C
623CH4424359	1F66F5DY6H0	33 C	623KH4425211	1F66F5DY5H0	35 K
623CH4424363	1F66F5DY7H0	33 C	623KH4425222	1F66F5DY9H0	35 K
623XH4424364	1F66F5DY1G0	36 X	623KH4425256	1F66F5DY7H0	35 K
623KH4424369	1F66F5DY4H0	35 K	623KH4425264	1F66F5DY4H0	35 K
623KH4424490	1F66F5DY3H0	35 K	623HH4425273	1F66F5DY9H0	36 H
623KH4424493	1F66F5DY7H0	35 K	623PH4425281	1F66F5DY9H0	35 P
623KH4424504	1F66F5DY7H0	35 K	623KH4425330	1F66F5DY3H0	35 K
623CH4424549	1F66F5DY6H0	33 C	623CH4425335	1F66F5DY3H0	33 C
623HH4424557	1F66F5DY7H0	36 H	623KH4425338	1F66F5DY9H0	35 K
623HH4424575	1F66F5DY9H0	36 H	623HH4425343	1F66F5DY7H0	36 H
623KH4424618	1F66F5DY0H0	35 K	623HH4425347	1F66F5DY4H0	36 H
623CH4424619	1F66F5DY0H0	33 C	623HH4425414	1F66F5DY1H0	36 H
623XH4424621	1F66F5DY6G0	36 X	623KH4425415	1F66F5DY6H0	35 K
623HH4424627	1F66F5DY4H0	36 H	623KH4425419	1F66F5DY7H0	35 K
623TH4424633	1F66F5DY8H0	34 T	623HH4425426	1F66F5DY4H0	36 H
623YH4424637	1F66F5DY4G0	36 Y	623HH4425467	1F66F5DY8H0	36 H
623YH4424645	1F66F5DY7G0	36 Y	623CH4425469	1F66F5DY0H0	33 C
623HH4424697	1F66F5DY6H0	36 H	623KH4425479	1F66F5DY5H0	35 K
623YH4424704	1F66F5DY0G0	36 Y	623HH4425487	1F66F5DY2H0	36 H

**Recall 191125REV Affected Unit Serial Numbers -
Holiday Rambler Vacationer**

Model Year 2017

UIN	CHASSIS VIN #	MODEL	UIN	CHASSIS VIN #	MODEL
623KH4425490	1F66F5DY1HC	35 K	623PH4426165	1F66F5DY9H	35 P
623KH4425547	1F66F5DY1HC	35 K	623PH4426172	1F66F5DY9H	35 P
623KH4425602	1F66F5DY9HC	35 K	623YH4426178	1F66F5DY9H	36 Y
623HH4425606	1F66F5DY8HC	36 H	623HH4426252	1F66F5DY4H	36 H
623CH4425612	1F66F5DY9HC	33 C	623KH4426285	1F66F5DY9H	35 K
623HH4425613	1F66F5DY2HC	36 H	623KH4426291	1F66F5DY4H	35 K
623CH4425650	1F66F5DY0HC	33 C	623KH4426300	1F66F5DY6H	35 K
623HH4425653	1F66F5DY4HC	36 H	623PH4426305	1F66F5DY5H	35 P
623KH4425656	1F66F5DY1HC	35 K	623PH4426309	1F66F5DY9H	35 P
623HH4425659	1F66F5DY0HC	36 H	623PH4426312	1F66F5DY2H	35 P
623KH4425661	1F66F5DYXH	35 K	623PH4426313	1F66F5DY4H	35 P
623YH4425670	1F66F5DY8HC	36 Y	623PH4426316	1F66F5DY7H	35 P
623KH4425672	1F66F5DY0HC	35 K	623CH4426364	1F66F5DY0H	33 C
623KH4425708	1F66F5DY8HC	35 K	623PH4426376	1F66F5DY9H	35 P
623CH4425711	1F66F5DY0HC	33 C	623HH4426379	1F66F5DY6H	36 H
623XH4425712	1F66F5DYXH	36 X	623PH4426380	1F66F5DY0H	35 P
623YH4425716	1F66F5DY9HC	36 Y	623PH4426384	1F66F5DY7H	35 P
623CH4425752	1F66F5DY4HC	33 C	623PH4426388	1F66F5DY9H	35 P
623KH4425756	1F66F5DY8HC	35 K	623PH4426445	1F66F5DY3H	35 P
623HH4425757	1F66F5DY3HC	36 H	623PH4426459	1F66F5DY6H	35 P
623KH4425761	1F66F5DY7HC	35 K	623HH4426469	1F66F5DYXH	36 H
623KH4425818	1F66F5DY9HC	35 K	623PH4426506	1F66F5DY3H	35 P
623KH4425819	1F66F5DY6HC	35 K	623HH4426521	1F66F5DY5H	36 H
623HH4425821	1F66F5DY6HC	36 H	623HH4426527	1F66F5DY1H	36 H
623KH4425822	1F66F5DYXH	35 K	623PH4426531	1F66F5DY5H	35 P
623PH4425831	1F66F5DY4HC	35 P	623KH4426534	1F66F5DY4H	35 K
623YH4425839	1F66F5DY6HC	36 Y	623PH4426535	1F66F5DY4H	35 P
623YH4425973	1F66F5DY6HC	36 Y	623KH4426592	1F66F5DY5H	35 K
623PH4425992	1F66F5DY0HC	35 P	623PH4426593	1F66F5DY7H	35 P
623KH4426058	1F66F5DY8HC	35 K	623HH4426601	1F66F5DY4H	36 H
623KH4426067	1F66F5DY0HC	35 K	623CH4426603	1F66F5DY3H	33 C
623KH4426072	1F66F5DY5HC	35 K	623PH4426605	1F66F5DY1H	35 P
623PH4426075	1F66F5DY3HC	35 P	623HH4426608	1F66F5DY1H	36 H
623HH4426078	1F66F5DYXH	36 H	623PH4426665	1F66F5DY8H	35 P
623KH4426080	1F66F5DY0HC	35 K	623KH4426670	1F66F5DY7H	35 K
623PH4426081	1F66F5DY9HC	35 P	623HH4426673	1F66F5DY8H	36 H
623KH4426083	1F66F5DY9HC	35 K	623PH4426682	1F66F5DYXH	35 P
623CH4426086	1F66F5DY4HC	33 C	623PH4426749	1F66F5DY4H	35 P
623KH4426100	1F66F5DY4HC	35 K	623KH4426756	1F66F5DYXH	35 K
623PH4426104	1F66F5DY0HC	35 P	623PH4426766	1F66F5DY9H	35 P
623PH4426115	1F66F5DY1HC	35 P	623HH4426776	1F66F5DYXH	36 H
623CH4426163	1F66F5DY0HC	33 C			

**Recall 191125REV Affected Unit Serial Numbers -
Holiday Rambler Vacationer**

Model Year 2018

UIN	CHASSIS VIN #	MODEL	UIN	CHASSIS VIN #	MODEL
623KJ4426873	1F66F5DY7H0	35 K	623HJ4427920	1F66F5DY8J0	36 H
623PJ4426886	1F66F5DY7H0	35 P	623KJ4427921	1F66F5DY4J0	35 K
623HJ4426894	1F66F5DY6H0	36 H	623KJ4427934	1F66F5DY9J0	35 K
623CJ4426900	1F66F5DY4H0	33 C	623KJ4427937	1F66F5DY2J0	35 K
623HJ4426941	1F66F5DY9H0	36 H	623KJ4427951	1F66F5DY7J0	35 K
623CJ4426949	1F66F5DY4H0	33 C	623PJ4428013	1F66F5DYXH0	35 P
623PJ4426950	1F66F5DY5H0	35 P	623HJ4428019	1F66F5DY6J0	36 H
623KJ4426969	1F66F5DY6H0	35 K	623PJ4428086	1F66F5DY9H0	35 P
623KJ4426972	1F66F5DY6H0	35 K	623KJ4428092	1F66F5DY5J0	35 K
623PJ4426973	1F66F5DY4H0	35 P	623PJ4428098	1F66F5DY5H0	35 P
623PJ4427029	1F66F5DY3H0	35 P	623KJ4428171	1F66F5DY7J0	35 K
623HJ4427031	1F66F5DY1H0	36 H	623KJ4428172	1F66F5DY8J0	35 K
623PJ4427037	1F66F5DY9H0	35 P	623KJ4428173	1F66F5DY0J0	35 K
623KJ4427039	1F66F5DY0H0	35 K	623KJ4428174	1F66F5DY6J0	35 K
623KJ4427047	1F66F5DY2H0	35 K	623PJ4428177	1F66F5DY7H0	35 P
623CJ4427175	1F66F5DYXH0	33 C	623PJ4428239	1F66F5DY9J0	35 P
623PJ4427187	1F66F5DY4H0	35 P	623KJ4428303	1F66F5DY6J0	35 K
623KJ4427192	1F66F5DY3H0	35 K	623KJ4428304	1F66F5DY3J0	35 K
623KJ4427195	1F66F5DYXH0	35 K	623KJ4428305	1F66F5DY9J0	35 K
623KJ4427198	1F66F5DY2H0	35 K	623CJ4428310	1F66F5DY3J0	33 C
623KJ4427264	1F66F5DY8H0	35 K	623CJ4428311	1F66F5DY0J0	33 C
623CJ4427268	1F66F5DY1H0	33 C	623KJ4428386	1F66F5DY5J0	35 K
623PJ4427271	1F66F5DY3H0	35 P	623KJ4428387	1F66F5DY2J0	35 K
623KJ4427274	1F66F5DY9H0	35 K	623PJ4428397	1F66F5DY5J0	35 P
623HJ4427331	1F66F5DY1H0	36 H	623PJ4428398	1F66F5DY9J0	35 P
623KJ4427394	1F66F5DY4H0	35 K	623PJ4428399	1F66F5DY7J0	35 P
623KJ4427404	1F66F5DY7H0	35 K	623CJ4428451	1F66F5DY1J0	33 C
623KJ4427408	1F66F5DY4H0	35 K	623HJ4428457	1F66F5DY1J0	36 H
623PJ4427414	1F66F5DY2H0	35 P	623KJ4428473	1F66F5DY6J0	35 K
623PJ4427420	1F66F5DY8H0	35 P	623KJ4428474	1F66F5DY5J0	35 K
623PJ4427469	1F66F5DY9H0	35 P	623KJ4428553	1F66F5DY0J0	35 K
623KJ4427484	1F66F5DY3H0	35 K	623KJ4428554	1F66F5DY4J0	35 K
623KJ4427495	1F66F5DY5H0	35 K	623PJ4428556	1F66F5DY5J0	35 P
623PJ4427620	1F66F5DY6H0	35 P	623PJ4428624	1F66F5DY3J0	35 P
623HJ4427625	1F66F5DY5H0	36 H	623KJ4428625	1F66F5DY1J0	35 K
623PJ4427634	1F66F5DY2H0	35 P	623KJ4428626	1F66F5DY8J0	35 K
623PJ4427639	1F66F5DY5H0	35 P	623HJ4428633	1F66F5DY9J0	36 H
623HJ4427644	1F66F5DY1H0	36 H	623CJ4428635	1F66F5DY7J0	33 C
623PJ4427766	1F66F5DY7H0	35 P	623PJ4428704	1F66F5DY8J0	35 P
623HJ4427768	1F66F5DY9H0	36 H	623KJ4428705	1F66F5DYXJ0	35 K
623CJ4427772	1F66F5DY7J0	33 C	623KJ4428707	1F66F5DY3J0	35 K
623KJ4427775	1F66F5DY9J0	35 K	623KJ4428709	1F66F5DY1J0	35 K
623KJ4427781	1F66F5DY0J0	35 K	623PJ4428716	1F66F5DY8J0	35 P
623KJ4427851	1F66F5DY9J0	35 K	623PJ4428788	1F66F5DY6J0	35 P
623KJ4427863	1F66F5DY4J0	35 K	623PJ4428789	1F66F5DY8J0	35 P
623KJ4427864	1F66F5DY1J0	35 K	623KJ4428790	1F66F5DY5J0	35 K
623KJ4427870	1F66F5DY8J0	35 K	623KJ4428791	1F66F5DY5J0	35 K
623KJ4427872	1F66F5DY2J0	35 K	623HJ4428798	1F66F5DYXJ0	36 H

**Recall 191125REV Affected Unit Serial Numbers -
Holiday Rambler Vacationer**

Model Year 2018

UIN	CHASSIS	VIN #	MODEL
623CJ4428854	1F66F5DY1J0		33 C
623KJ4428865	1F66F5DY3J0		35 K
623KJ4428866	1F66F5DY9J0		35 K
623PJ4428879	1F66F5DY3J0		35 P
623KJ4428993	1F66F5DY8J0		35 K
623KJ4428994	1F66F5DY6J0		35 K
623KJ4429067	1F66F5DY1J0		35 K
623PJ4429069	1F66F5DY5J0		35 P
623KJ4429139	1F66F5DY2J0		35 K
623PJ4429140	1F66F5DY1J0		35 P
623PJ4429199	1F66F5DYXJ0		35 P
623PJ4429207	1F66F5DY6J0		35 P
623KJ4429218	1F66F5DY9J0		35 K
623PJ4429219	1F66F5DY5J0		35 P
623KJ4429221	1F66F5DY2J0		35 K
623KJ4429287	1F66F5DY1J0		35 K
623KJ4429289	1F66F5DY3J0		35 K
623KJ4429360	1F66F5DY7J0		35 K
623PJ4429362	1F66F5DY5J0		35 P
623KJ4429412	1F66F5DY2J0		35 K
623KJ4429413	1F66F5DY4J0		35 K
623KJ4429414	1F66F5DY9J0		35 K
623CJ4429491	1F66F5DY4J0		33 C

UIN	CHASSIS	VIN #	MODEL
623PJ4429498	1F66F5DY6J0A		35 P
623KJ4429571	1F66F5DYXJ0A		35 K
623KJ4429572	1F66F5DY9J0A		35 K
623KJ4429573	1F66F5DY4J0A		35 K
623PJ4429575	1F66F5DYXJ0A		35 P
623PJ4429576	1F66F5DY8J0A		35 P
623PJ4429625	1F66F5DY2J0A		35 P
623PJ4429631	1F66F5DY8J0A		35 P
623PJ4429736	1F66F5DY6J0A		35 P
623PJ4429737	1F66F5DY4J0A		35 P
623KJ4429815	1F66F5DY2J0A		35 K
623KJ4429876	1F66F5DY2J0A		35 K
623CJ4429939	1F66F5DY4J0A		33 C
623CJ4429940	1F66F5DY5J0A		33 C
623PJ4429941	1F66F5DY4J0A		35 P
623PJ4429942	1F66F5DY6J0A		35 P
623KJ4430001	1F66F5DY1J0A		35 K
623PJ4430003	1F66F5DY3J0A		35 P
623PJ4430004	1F66F5DY8J0A		35 P
623KJ4430059	1F66F5DY1J0A		35 K
623PJ4430132	1F66F5DY3J0A		35 P
623PJ4430193	1F66F5DY0J0A		35 P

Model Year 2019

UIN	CHASSIS	VIN #	MODEL
623CK4430382	1F66F5DY7J0		33 C
623CK4430383	1F66F5DY9J0		33 C
623PK4430390	1F66F5DY3J0		35 P
623PK4430391	1F66F5DY1J0		35 P
623KK4430392	1F66F5DY5J0		35 K
623KK4430393	1F66F5DY4J0		35 K
623CK4430456	1F66F5DY1J0		33 C
623PK4430464	1F66F5DY5J0		35 P
623KK4430465	1F66F5DY3J0		35 K
623KK4430466	1F66F5DY2J0		35 K
623KK4430467	1F66F5DY7J0		35 K
623PK4430469	1F66F5DY4J0		35 P
623PK4430470	1F66F5DY2J0		35 P
623PK4430472	1F66F5DY3J0		35 P
623KK4430528	1F66F5DY4J0		35 K
623KK4430598	1F66F5DY6J0		35 K
623KK4430599	1F66F5DY6J0		35 K
623KK4430600	1F66F5DY9J0		35 K
623CK4430613	1F66F5DYXJ0		33 C

UIN	CHASSIS	VIN #	MODEL
623CK4430614	1F66F5DY3J		33 C
623PK4430616	1F66F5DY1J		35 P
623CK4430617	1F66F5DYXJ		33 C
623CK4430666	1F66F5DY6J		33 C
623KK4430670	1F66F5DYXJ		35 K
623KK4430671	1F66F5DY6J		35 K
623KK4430672	1F66F5DY4J		35 K
623PK4430681	1F66F5DY0J		35 P
623PK4430682	1F66F5DY7J		35 P
623CK4430739	1F66F5DY4J		33 C
623KK4430757	1F66F5DY2J		35 K
623KK4430758	1F66F5DY5J		35 K
623KK4430759	1F66F5DY4J		35 K
623PK4430761	1F66F5DY4J		35 P
623KK4430808	1F66F5DY1J		35 K
623KK4430809	1F66F5DY0J		35 K
623PK4430810	1F66F5DY2J		35 P
623CK4430883	1F66F5DY3J		33 C
623KK4430884	1F66F5DY6J		35 K

**Recall 191125REV Affected Unit Serial Numbers -
Holiday Rambler Vacationer**

Model Year 2019

UIN	CHASSIS	VIN #	MODEL	UIN	CHASSIS	VIN #	MODEL
623KK4430885	1F66F5DY9J		35 K	623KK4432115	1F66F5DY8K0		35 K
623PK4430887	1F66F5DY3J		35 P	623KK4432117	1F66F5DY0K0		35 K
623PK4430973	1F66F5DY5J		35 P	623CK4432164	1F66F5DY4K0		33 C
623KK4430974	1F66F5DY3J		35 K	623KK4432173	1F66F5DY3K0		35 K
623KK4430975	1F66F5DYXJ		35 K	623KK4432216	1F66F5DY8K0		35 K
623CK4431036	1F66F5DY0J		33 C	623CK4432217	1F66F5DYXK0		33 C
623PK4431037	1F66F5DY6J		35 P	623KK4432221	1F66F5DY2K0		35 K
623KK4431048	1F66F5DY8J		35 K	623PK4432222	1F66F5DY4K0		35 P
623KK4431049	1F66F5DYXJ		35 K	623CK4432253	1F66F5DY7K0		33 C
623KK4431121	1F66F5DY8J		35 K	623CK4432261	1F66F5DYXK0		33 C
623PK4431122	1F66F5DY7J		35 P	623KK4432266	1F66F5DY7K0		35 K
623KK4431123	1F66F5DY8J		35 K	623KK4432267	1F66F5DY5K0		35 K
623KK4431124	1F66F5DY6J		35 K	623CK4432315	1F66F5DY4K0		33 C
623KK4431193	1F66F5DY3J		35 K	623KK4432316	1F66F5DY3K0		35 K
623KK4431194	1F66F5DY1J		35 K	623KK4432348	1F66F5DY1K0		35 K
623KK4431249	1F66F5DY8J		35 K	623PK4432364	1F66F5DY7K0		35 P
623PK4431250	1F66F5DY3J		35 P	623KK4432428	1F66F5DY2K0		35 K
623KK4431253	1F66F5DY3J		35 K	623CK4432432	1F66F5DY2K0		33 C
623CK4431331	1F66F5DY6J		33 C	623KK4432463	1F66F5DY7K0		35 K
623KK4431332	1F66F5DYXJ		35 K	623CK4432471	1F66F5DY9K0		33 C
623CK4431394	1F66F5DYXJ		33 C	623CK4432477	1F66F5DY0K0		33 C
623KK4431399	1F66F5DY6J		35 K	623CK4432479	1F66F5DY0K0		33 C
623KK4431401	1F66F5DY5J		35 K	623KK4432483	1F66F5DY1K0		35 K
623KK4431402	1F66F5DY9J		35 K	623KK4432522	1F66F5DY0K0		35 K
623KK4431455	1F66F5DY4J		35 K	623KK4432526	1F66F5DY8K0		35 K
623KK4431456	1F66F5DY2J		35 K	623CK4432534	1F66F5DY9K0		33 C
623CK4431521	1F66F5DY1J		33 C	623KK4432537	1F66F5DY3K0		35 K
623KK4431522	1F66F5DY6J		35 K	623CK4432629	1F66F5DY0K0		33 C
623CK4431525	1F66F5DYXJ		33 C	623KK4432709	1F66F5DY3K0		35 K
623CK4431526	1F66F5DY0J		33 C	623KK4432712	1F66F5DYXK0		35 K
623KK4431528	1F66F5DY8J		35 K	623KK4432743	1F66F5DYXK0		35 K
623KK4431529	1F66F5DY6J		35 K	623KK4432753	1F66F5DY1K0		35 K
623KK4431530	1F66F5DY7J		35 K	623PK4432757	1F66F5DY9K0		35 P
623PK4431660	1F66F5DY2K		35 P	623KK4432769	1F66F5DY6K0		35 K
623KK4431676	1F66F5DY3J		35 K	623KK4432806	1F66F5DY6K0		35 K
623CK4431719	1F66F5DY1K		33 C	623KK4432820	1F66F5DY5K0		35 K
623KK4431721	1F66F5DY7K		35 K	623CK4432826	1F66F5DY2K0		33 C
623CK4431852	1F66F5DY5K		33 C	623CK4432880	1F66F5DY3K0		33 C
623KK4431853	1F66F5DY1J		35 K	623CK4432881	1F66F5DY3K0		33 C
623KK4431906	1F66F5DY5K		35 K	623KK4432883	1F66F5DY5K0		35 K
623KK4431907	1F66F5DY9K		35 K	623KK4432884	1F66F5DY5K0		35 K
623CK4431909	1F66F5DYXK		33 C	623KK4432946	1F66F5DY3K0		35 K
623CK4431966	1F66F5DY9K		33 C	623CK4432952	1F66F5DY8K0		33 C
623PK4432002	1F66F5DY6K		35 P	623KK4432965	1F66F5DY8K0		35 K
623PK4432008	1F66F5DY2K		35 P	623KK4433023	1F66F5DY9K0		35 K
623KK4432055	1F66F5DY1K		35 K	623CK4433088	1F66F5DY4K0		33 C
623CK4432059	1F66F5DY5K		33 C	623KK4433090	1F66F5DY7K0		35 K
623KK4432061	1F66F5DY1K		35 K	623KL4433134	1F66F5DY5K0		35 K

**Recall 191125REV Affected Unit Serial Numbers -
Holiday Rambler Vacationer**

Model Year 2020

UIN	CHASSIS	VIN #	MODEL
623CL4433206	1F66F5DY0K0		33 C
623KL4433221	1F66F5DY3K0		35 K
623CL4433244	1F66F5DY7K0		33 C
623KL4433285	1F66F5DY2K0		35 K
623PL4433294	1F66F5DY4K0		35 P
623CL4433304	1F66F5DY5K0		33 C
623PL4433338	1F66F5DY7K0		35 P
623CL4433344	1F66F5DY6K0		33 C
623KL4433389	1F66F5DY7K0		35 K
623CL4433399	1F66F5DY6K0		33 C
623KL4433507	1F66F5DY1K0		35 K

UIN	CHASSIS	VIN #	MODEL
623KL4433511	1F66F5DY7K0		35 K
623CL4433583	1F66F5DY4K0		33 C
623PL4433591	1F66F5DY5K0		35 P
623KL4433603	1F66F5DY2K0		35 K
623KL4433606	1F66F5DY2K0		35 K
623KL4433625	1F66F5DYXK0		35 K
623KL4433681	1F66F5DY9K0		35 K
623CL4433756	1F66F5DY2K0		33 C
623KL4433764	1F66F5DY1K0		35 K
623PL4433766	1F66F5DY8K0		35 P