



David J. Johnson
 Director
 Service Engineering Operations
 Ford Customer Service Division

Ford Motor Company
 P. O. Box 1904
 Dearborn, Michigan 48121

November 21, 2019

TO: All U.S. Ford and Lincoln Dealers

SUBJECT: NEW VEHICLE DEMONSTRATION / DELIVERY HOLD

Compliance Recall 19C07 – Supplement #5

Certain 2018-2020 Model Year Escape, Explorer, F-150, Superduty, Expedition and Aviator Vehicles Equipped with Manual Reclining Seats
 Manual Recliner Seat Inspection

New! REASON FOR THIS SUPPLEMENT

- 2018-19 Police Interceptor Utility (Explorer) vehicles were inadvertently included in this program and have been removed. An updated owner letter will be sent to customers
NOTE: 2020 Police Interceptor Utility vehicles are included in 19C07 and will still require inspection of the rear seats per the bulletin
- Update to labor allowances chart to allow for torque wrench usage on vehicles where access to the back of the seat is not possible such as a protective cage in Police units.

AFFECTED VEHICLES

Vehicle	Model Year	Assembly Plant	Build Dates
F-150	2018-2020	Dearborn	14-Sep-2018 through 07-Aug-2019
		Kansas City	10-Sep-2018 through 31-Aug-2019
F-250 – F-550	2019-2020	Kentucky Truck	09-Sept-2018 through 30-Aug-2019
		Ohio	11-Sep-2018 through 17-Jul-2019
Explorer	2018-2020	Chicago	08-Sep-2018 through 22-Sep-2019
Aviator	2020	Chicago	12-Apr-2019 through 22-Sep-2019
Expedition	2019-2020	Kentucky	16-Oct-2018 through 31-Aug-2019
Escape	2020	Louisville	4-Apr-2019 through 21- Sep-2019

Affected vehicles are identified in OASIS and FSA VIN Lists.

REASON FOR THIS COMPLIANCE RECALL

Some of the affected vehicles may not conform to the requirements specified by Federal Motor Vehicle Safety Standard (FMVSS) No. 202a (Head Restraints) and FMVSS 207 (Seating Systems). The seatback may exhibit excessive movement, as a result of an improperly assembled recliner mechanism. This concern affects front row manual seat recliners on all vehicles listed except for the 2020 MY Explorer and Aviator, for which the issue pertains only to second row outboard seats.

SERVICE ACTION

Before demonstrating or delivering any new in-stock vehicles involved in this recall, dealers are to inspect the manual recliner mechanism on front seats for the following vehicles and repair if necessary:

- 2018-2020 F-150
- 2018-2019 Explorer
- 2019-2020 Superduty, Expedition
- 2020 Escape

Before demonstrating or delivering any new in-stock vehicles involved in this recall, dealers are to inspect the manual recliner mechanism on rear seats for the following vehicles and repair if necessary:

- 2020 Explorer and Aviator

It is expected that less than 1% of vehicles will not pass the inspection, and will require part replacement. Follow repair instructions to repair any failed seat. This service must be performed on all affected vehicles at no charge to the vehicle owner.

NOTE: There will be a primary and alternate inspection procedure available. Dealers have all been shipped a Force Gauge to support the primary inspection procedure. Refer to the technical instructions for further details. Tips for Force Gauge usage are in Attachment V of this bulletin.

OWNER NOTIFICATION MAILING SCHEDULE

Owner letters will be mailed the week of October 21, 2019. Dealers should repair any affected vehicles that arrive at their dealerships, whether or not the customer has received a letter.

PLEASE NOTE:

Federal law requires dealers to complete this recall service before a new vehicle is delivered to the buyer or lessee. Violation of this requirement by a dealer could result in a civil penalty of up to \$21,000 per vehicle. Correct all vehicles in your new vehicle inventory before delivery.

ATTACHMENTS

<i>Attachment I:</i>	<i>Administrative Information</i>
<i>Attachment II:</i>	<i>Labor Allowances and Parts Ordering Information</i>
Attachment III:	Mechanical Seat Inspection Technical Instructions
Attachment IV:	Torque Fixture Fabrication
Attachment V:	Force Gauge Usage Tips
Attachment VI:	Repair Instructions
Owner Letters	

QUESTIONS & ASSISTANCE

For questions and assistance, contact the Special Service Support Center (SSSC) via the SSSC Web Contact Site. The SSSC Web Contact Site can be accessed through the Professional Technician Society (PTS) website using the SSSC link listed at the bottom of the OASIS VIN report screen or listed under the SSSC tab.

Sincerely,

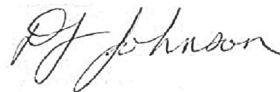

David J. Johnson

NEW VEHICLE DEMONSTRATION / DELIVERY HOLD**Compliance Recall 19C07 - Supplement #5**

Certain 2018-2020 Model Year Escape, Explorer, F-150, Super Duty, Expedition and Aviator Vehicles
Equipped with Manual Reclining Seats
Manual Recliner Seat Inspection

OASIS ACTIVATION

OASIS was activated on August 29, 2019

FSA VIN LISTS ACTIVATION

FSA VIN Lists were made available through <https://web.fsavinlists.dealerconnection.com> August 29, 2019. Owner names and addresses were made available the week of November 11, 2019.

NOTE: Your FSA VIN Lists may contain owner names and addresses obtained from motor vehicle registration records. The use of such motor vehicle registration data for any purpose other than in connection with this recall is a violation of law in several states, provinces, and countries. Accordingly, you must limit the use of this listing to the follow-up necessary to complete this recall.

SOLD VEHICLES

- Use OASIS to verify affected VINs, as some vehicles that were recently removed from the program are now included.
- Ford has not issued instructions to stop selling/delivering or driving used vehicles under this compliance recall. Owners should contact their dealer for an appointment to have their vehicles remedied as soon as practicable. Owners can continue to safely drive their vehicles.
- Immediately contact any of your affected customers whose vehicles are not on your VIN list but are identified in OASIS. Give the customer a copy of the Owner Notification Letter (when available) and schedule a service date.
- Correct other affected vehicles identified in OASIS which are brought to your dealership.
- Dealers are to prioritize repairs of customer vehicles over repairs of new and used vehicle inventory.

STOCK VEHICLES

- Use OASIS to verify affected VINs, as some vehicles that were recently removed from the program are now included.
- Dealers must inspect all affected stock units prior to delivery.
- Correct all affected units in your new vehicle inventory before delivery.
- Ford has developed a primary and alternative test procedure to ensure dealers are able to inspect stock units.
- The primary (preferred) inspection procedure requires a Force Gauge that Ford will ship to dealers in late August and through the month of September.
- An alternative inspection procedure is available for use prior to receiving a Force Gauge. This procedure requires a 250 foot pound Torque Wrench and the fabrication of a Torque Fixture. Instructions are included in Attachment IV of this bulletin for fabrication of the fixture. Dealers will be provided an allowance to purchase a tool locally and to modify the tool. See Claims Payment in Claims Preparation and Submission in Attachment I.
- Dealers may use the Torque Wrench inspection procedure on stock units for which they have a signed sales agreement or vehicles that customers are interested in test-driving. The Torque Wrench inspection procedure may not be used after dealerships receive the Force Gauge from Ford.

NEW VEHICLE DEMONSTRATION / DELIVERY HOLD**Compliance Recall 19C07 - *Supplement #5***

Certain 2018-2020 Model Year Escape, Explorer, F-150, Super Duty, Expedition and Aviator Vehicles
Equipped with Manual Reclining Seats
Manual Recliner Seat Inspection

STOCK VEHICLES (Continued)

- All regular cab F-150 and regular cab Superduty should be completed using only the Torque Wrench inspection procedure.
- Use OASIS to identify any affected vehicles in your used vehicle inventory

DEALER-OPERATED RENTAL VEHICLES

The Fixing America's Surface Transportation (FAST) Act law effective June 2016 prohibits a rental company from selling, renting or leasing vehicles subject to a safety or compliance recall. Please consult your legal counsel for legal advice.

TITLE BRANDED / SALVAGED VEHICLES

Affected title branded and salvaged vehicles are eligible for this recall.

OWNER REFUNDS

Refunds are not approved for this program.

RENTAL VEHICLES

Rental vehicle eligibility can be reviewed by SSSC on customer owned vehicles that fail inspection only and require part ordering.

LINCOLN PICKUP AND DELIVERY

Owners of 2017 MY and newer Lincoln vehicles have the option of requesting pickup and delivery service with a Lincoln loaner (up to 2 days), from their dealership. For details, reference EFC07715, 2019 Lincoln Pickup & Delivery Updates.

ADDITIONAL REPAIR (LABOR TIME AND/OR PARTS)

Additional repairs identified as necessary to complete the FSA should be managed as follows:

- For related damage and access time requirements, refer to the Warranty and Policy Manual / Section 6 – Ford & Lincoln Program Policies / General Information & Special Circumstances for FSA's / Related Damage.
- For vehicles within new vehicle bumper-to-bumper warranty coverage, no SSSC approval is required, although related damage must be on a separate repair line with the "Related Damage" radio button checked.
 - Ford vehicles – 3 years or 36,000 miles
 - Lincoln vehicles – 4 years or 50,000 miles
- For vehicles outside new vehicle bumper-to-bumper warranty coverage, submit an Approval Request to the SSSC Web Contact Site prior to completing the repair.

NEW VEHICLE DEMONSTRATION / DELIVERY HOLD**Compliance Recall 19C07 - Supplement #5**

Certain 2018-2020 Model Year Escape, Explorer, F-150, Super Duty, Expedition and Aviator Vehicles
Equipped with Manual Reclining Seats
Manual Recliner Seat Inspection

CLAIMS PREPARATION AND SUBMISSION

- **Claim Entry:** Enter claims using Dealer Management System (DMS) or One Warranty Solution (OWS) online.
 - When entering claims, select claim type 31: Field Service Action. The FSA number (19C07) is the sub code.
 - For additional claims preparation and submission information, refer to the Recall and Customer Satisfaction Program (CSP) Repairs in the OWS User Guide.
- **Related Damage/Additional labor and/or parts:** Must be claimed as Related Damage on a separate repair line from the FSA with same claim type and sub code as described in Claim Entry above.

IMPORTANT: Click the Related Damage Indicator radio button.

- **Lincoln Pickup & Delivery:** Claims for Lincoln Pickup & Delivery with a Lincoln loaner (up to 2 days) should be submitted on a separate line from the FSA. Refer to EFC07715, 2019 Lincoln Pickup & Delivery Updates for details.
- **Provision for Locally Obtained Supplies to Fabricate Torque Fixture:** H style gear puller referenced in technical instructions and fabrication required.

NOTE: This is a one-time charge per dealer as tool can be used on multiple vehicles. Do not charge this amount more than once.

- Program Code: 19C07
- Misc. Expense: OTHER
- Amount: actual up to \$100
- **Time Recording Requirements:**
 - Time recording requirements, as specified in the Warranty & Policy Manual, are **not required** for this recall when performing the **Force Gauge inspection procedure**. Claims submitted without recording technician time will be accepted.
 - Time recording requirements, as specified in the Warranty & Policy Manual, are **required** for this recall when performing the **Torque Wrench Inspection Procedure**.

DAMAGED OR BROKEN FORCE GAUGES

Dealers should contact SSSC if they receive a broken Force Gauge or a Force Gauge breaks during use and a replacement is needed. Information required is:

- Make and model of Force Gauge (i.e. Shimpo FG-3009, Nextec DFS-1000, etc.)
- Description of issue
- Photo of damage

NOTE: Dealers should not contact SSSC for broken extension rod attachments. Extension rod attachments should not be used (even if provided with the tool) unless the threaded connections of the Force Gauge are under-flush with the Force Gauge housing (currently only the Mecmesin AFG-1000 and BFG-1000 require the use of an extension rod attachment).

NEW VEHICLE DEMONSTRATION / DELIVERY HOLD**Compliance Recall 19C07 - Supplement #5**

Certain 2018-2020 Model Year Escape, Explorer, F-150, Super Duty, Expedition and Aviator Vehicles
Equipped with Manual Reclining Seats
Manual Recliner Seat Inspection

NOTE: Inspection Passes and Inspection Failed labor allowance table has been split to differentiate the labor operations. Please ensure the correct labor operations are used.

INSPECTION PASSES LABOR ALLOWANCES

Description	Vehicle	Labor Operation	Labor Time
Inspect Front Seat Manual Recliner Mechanism using Force Gauge . <ul style="list-style-type: none"> All Seats Pass, closes program. 	All Vehicles <u>except</u> F150/Superduty Regular Cab, 2020 Explorer and Aviator	19C07A	0.3 Hours
Inspect Front Seat Manual Recliner Mechanism using Torque Wrench and Holding Fixture . <ul style="list-style-type: none"> All Seats Pass, closes program. 	F150/Superduty Regular Cab only or for special situations on other vehicles*	19C07B	1.2 Hours
Inspect Rear Outboard Seat Inner Recliner Mechanism using Force Gauge . <ul style="list-style-type: none"> All Seats Pass, closes program. 	2020 Explorer and Aviator Only	19C07C	0.3 Hours
Inspect Rear Outboard Seat Inner Recliner Mechanism using Torque Wrench and Holding Fixture . <ul style="list-style-type: none"> All Seats Pass, closes program. 	2020 Explorer and Aviator Only*	19C07D	0.7 Hours

* Torque Wrench and Holding Fixture procedure can be used on all vehicles if the Force Gauge is currently damaged and the SSSC has been contacted for a replacement. **Also, can be used when access to back of seat is not possible such as a protective cage on Police units.**

INSPECTION FAILED LABOR ALLOWANCES (Program stays open, an unsold vehicle cannot be delivered until repairs are performed)

Description	Vehicle	Labor Operation	Labor Time
Inspect Front Seat Manual Recliner Mechanism using Force Gauge . <ul style="list-style-type: none"> Seat Fails Inspection, program stays open. Can be claimed with 19C07J, 19C07K or 19C07L. 	All Vehicles <u>except</u> F150/Superduty Regular Cab, 2020 Explorer and Aviator	19C07EE	0.3 Hours
Inspect Front Seat Manual Recliner Mechanism using Torque Wrench and Holding Fixture . <ul style="list-style-type: none"> Seat Fails Inspections, program stays open. Can be claimed with 19C07J, 19C07K or 19C07L. 	F150/Superduty Regular Cab only or for special situations on other vehicles*	19C07FF	1.2 Hours

NEW VEHICLE DEMONSTRATION / DELIVERY HOLD**Compliance Recall 19C07 - Supplement #5**

Certain 2018-2020 Model Year Escape, Explorer, F-150, Super Duty, Expedition and Aviator Vehicles
Equipped with Manual Reclining Seats
Manual Recliner Seat Inspection

INSPECTION FAILED LABOR ALLOWANCES (Program stays open, an unsold vehicle cannot be delivered until repairs are performed)

Description	Vehicle	Labor Operation	Labor Time
Inspect Rear Outboard Seat Inner Recliner Mechanism using Force Gauge . <ul style="list-style-type: none"> Seat Fails Inspection, program stays open. Can be claimed with 19C07M or 19C07N. 	2020 Explorer and Aviator Only	19C07GG	0.3 Hours
Inspect Rear Outboard Seat Inner Recliner Mechanism using Torque Wrench and Holding Fixture . (Only to be used if Force Gauge is damaged and waiting on replacement.) <ul style="list-style-type: none"> Seat Fails Inspection, program stays open. Can be claimed with 19C07M or 19C07N. 	2020 Explorer and Aviator Only*	19C07HH	0.7 Hours

* Torque Wrench and Holding Fixture procedure can be used on all vehicles, only if the Force Gauge is currently damaged and the SSSC has been contacted for a replacement. **Also, can be used when access to back of seat is not possible such as a protective cage on Police units.**

REPAIR LABOR ALLOWANCES - FRONT SEAT FRAME BACK REPLACEMENT

Description	Vehicle	Labor Operation	Labor Time
Replace Passenger Seat Frame Back <ul style="list-style-type: none"> Can be claimed with 19C07EE or 19C07FF. 	All Vehicles <u>except</u> 2020 Explorer and Aviator	19C07J	1.4 Hours
Replace Driver Seat Frame Back <ul style="list-style-type: none"> Can be claimed with 19C07EE or 19C07FF. 	All Vehicles <u>except</u> 2020 Explorer and Aviator	19C07K	1.3 Hours
Replace Both Seat Frame Backs <ul style="list-style-type: none"> Can be claimed with 19C07EE or 19C07FF 	All Vehicles <u>except</u> 2020 Explorer and Aviator Only	19C07L	2.5 Hours

REPAIR LABOR ALLOWANCES - REAR SEAT FRAME REPLACEMENT 2020 EXPLORER AND AVIATOR

Description	Vehicle	Labor Operation	Labor Time
Replace Outboard Seat Frame, Driver or Passenger Side <ul style="list-style-type: none"> Can be claimed with 19C07GG or 19C07HH. 	2020 Explorer and Aviator only	19C07M	1.8 Hours
Replace Both Outboard Seat Frames <ul style="list-style-type: none"> Can be claimed with 19C07GG or 19C07HH. 	2020 Explorer and Aviator only	19C07N	3.4 Hours

**NEW VEHICLE DEMONSTRATION / DELIVERY HOLD
Compliance Recall 19C07 - *Supplement #5***

Certain 2018-2020 Model Year Escape, Explorer, F-150, Super Duty, Expedition and Aviator Vehicles
Equipped with Manual Reclining Seats
Manual Recliner Seat Inspection

PARTS REQUIREMENTS / ORDERING INFORMATION

SSSC Web Contact Site:

To place an order for a seat frame submit a VIN-specific Part Order contact via the SSSC Web Contact Site.

Part Number	Description	Order Quantity	Claim Quantity
FU5Z-9661019-H	Driver Front Seat Back Frame (All except 2020 Escape)	1	1
FU5Z-9661018-AF	Passenger Front Seat Back Frame (All except, 2020 Escape)	1	1
JU5Z-9661019-D	Driver Front Seat Back Frame (2020 Escape)	1	1
JU5Z-9661018-N	Passenger Front Seat Back Frame (2020 Escape)	1	1
-99613A10-	Rear Seat Back Frame (2020 Explorer/Aviator vehicle specific)	1	1

Less than 1% of the affected vehicle population is expected to require seat frame replacement.

Order the parts below through normal order processing channels:

Part Number	Description	Order Quantity	Claim Quantity
-96610A16-	Head Rest Sleeve (Front and Rear seats, vehicle specific, Left and Right sleeves are different on seat)	2	2
W715828-S437	Seat Back to Seat Track Frame Bolts (All Front Seats, 4 required, 4 in pkg)	1	4
W718633-S451	Seat Track Bolts (F150 all four, Expedition front of seat track only, 4 in pkg)	1	4 for F150, 2 for Exp.
W719352-S451	Seat Track Bolts (Expedition rear of seat track only, 4 in pkg)	1	2
W717731-S451	Seat Track Bolts (Superduty, 4 in pkg)	1	4
W709428-S424	Seat Track Bolts (2018-2019 Explorer, Front of seat track only, 4 in pkg)	1	2
W709622-S424	Seat Track Bolts (2018-2019 Explorer, Rear of seat track only, 4 in pkg)	1	2
W719675-S451	Seat Track Bolts (2020 Escape, 4 in pkg)	1	4

NEW VEHICLE DEMONSTRATION / DELIVERY HOLD

Compliance Recall 19C07 - *Supplement #5*

Certain 2018-2020 Model Year Escape, Explorer, F-150, Super Duty, Expedition and Aviator Vehicles
Equipped with Manual Reclining Seats
Manual Recliner Seat Inspection

DEALER PRICE

For latest prices, refer to DOES II.

PARTS RETENTION AND RETURN

Follow the provisions of the Warranty and Policy Manual, Section 1 - WARRANTY PARTS
RETENTION AND RETURN POLICIES.

EXCESS STOCK RETURN

Excess stock returned for credit must have been purchased from Ford Customer Service Division in
accordance with Policy Procedure Bulletin 4000.

CERTAIN 2018-2020 MODEL YEAR ESCAPE, EXPLORER, F-150, SUPER DUTY, EXPEDITION AND AVIATOR VEHICLES EQUIPPED WITH MANUAL RECLINING SEATS

MANUAL RECLINER SEAT INSPECTION

OVERVIEW

Some of the affected vehicles may not conform to the requirements specified by Federal Motor Vehicle Safety Standard (FMVSS) No. 202a (Head Restraints) and FMVSS 207 (Seating Systems). The seatback may exhibit excessive movement, as a result of an improperly assembled recliner mechanism. This concern affects front row manual seat recliners on all vehicles listed except for the 2020 MY Explorer and Aviator, for which the issue pertains only to second row outboard seats with manual recliners. Before demonstrating or delivering any new in-stock vehicles involved in this recall, dealers are to inspect the manual recliner mechanism on front seats for the following vehicles and repair if necessary:

- 2018-2020 F-150
- 2018-2019 Explorer
- 2019-2020 Superduty and Expedition
- 2020 Escape

Before demonstrating or delivering any new in-stock vehicles involved in this recall, dealers are to inspect the manual recliner mechanism on rear seats for the following vehicles and repair if necessary:

- 2020 Explorer and Aviator

- For all Regular Cab F150's and Regular Cab Superduty's perform the Torque Wrench Inspection Procedure only. The Force Gauge will not work effectively on the front seats of the Regular cab F150 and Regular Cab Super duty configuration.

NOTE: All Dealers have been mailed a Force Gauge. All vehicles should be checked using the Force Gauge except for Regular Cab F150's and Regular Cab Superduty's. If you have a damaged Force Gauge please reference Dealer Bulletin on obtaining a replacement.

NOTE: The Torque fixture for Torque Wrench Inspection is locally obtained and must be modified. Please see ATTACHMENT IV for tool modification instructions.

NOTE: This program only applies to manual reclining seats. Some vehicles may have a combination of front seat types from driver to passenger side including manual seats with manual recliners, power seats with manual recliners, or power seats with power recliners. Both front seats should be visually inspected to determine recliner type and service action required. 2020 Explorer and Aviator vehicles only require inspection of outer rear seats, which are all manual reclining seats. Refer to technical instructions for further detail.



FRONT SEAT FORCE GAUGE INSPECTION PROCEDURE

For All Vehicles Except 2020 Explorer/Aviator, Regular Cab F150 and Regular Cab Superduty

IMPORTANT! This procedure must be performed on front seats equipped with manual recliners. Perform the inspection procedure on both front seats, if applicable.

NOTE: Only Inspect Manual Recliner Seats.

NOTE: Video is available of procedure. 

1. Pull up on the manual recliner handle and fold the front seat backrest forward. Let go of the recliner handle and position the front seat backrest upright to the first lock position.
2. Recline the front seat backrest to the 2nd or 3rd recliner lock position.
3. Place hand between the headrest guide posts and give the seat back a slight shake to ensure seat latch has fully locked all the pawls prior to applying the 850N force.
4. Attach the 4 inch pressure plate to the Force Gauge.

NOTICE: The mandrel thread on some Force Gauges may extend past the surface of the pressure plate. This condition may damage the seat during inspection. Use an M6 nut as a spacer on the Force Gauge mandrel threads if required, to ensure a sub-finish surface.

5. Zero out the Force Gauge.
6. Set the Force Gauge to capture/hold the highest value reached.



NOTE: Position a clean shop cloth between the Force Gauge pressure plate and the seat backrest cover.

7. While sitting in the second row seat, place the Force Gauge pressure plate on the upper inboard and outboard sides of the front seat backrest, 1 inch from the top and 1 inch from the side of the backrest, and apply pressure until a minimum of 850N (0.850kN) force is achieved or seat back ratchets forward (If the seat back ratchets there will be an audible noise). See Figure 1.

NOTICE: Do not exceed 950N (0.950kN) force, damage to the seat back could occur.

NOTE: Zero out the Force Gauge between each measurement.



FIGURE 1



8. Was a loud ratcheting sound heard or did the seat back ratchet forward on either seat from the inboard and/or the outboard sides before 850N (0.850kN) of force was reached?

NOTE: Example video of failed recliner. 

Yes - This seat has failed inspection and will require replacement. Reference Attachment VI for repair procedure and Dealer Bulletin for parts ordering information.

No - Go to step 9.

9. If the seat backrest passes the first inspection, reset the seat backrest by performing the following steps.

- a. Pull up on the manual recliner handle and fold the front seat backrest forward. Let go of the recliner handle and position the front seat backrest upright to the first lock position.
- b. Recline the front seat backrest to the 2nd or 3rd recliner lock positions.

10. Repeat Step 7 a second time to ensure that the seat backrest passes inspection.

NOTE: After second inspection if recliner does not make a ratcheting sound or ratchets forward it passes inspection, go to Step 11.

11. Record the highest value reached on both inboard and outboard upper front seat backrest positions on repair order.

For All 2020 Explorer and Aviator Vehicles : All Second Row Seat/s

IMPORTANT! Perform the inspection procedure on both rear outboard seats.

NOTE: Only the inboard side of the outer seats needs to be inspected.

NOTE: Video is available for procedure. 

1. Pull up on the manual recliner handle and fold the front seat backrest forward. Let go of the recliner handle and position the front seat backrest upright to the first lock position.



2. Recline the rear seat backrest to full recline.
3. Place hand between the headrest guide posts and give the seat back a slight shake to ensure seat latch has fully locked all the pawls prior to applying the 850N force.
4. Attach the 4 inch pressure plate to the Force Gauge.

NOTICE: The mandrel thread on some Force Gauges may extend past the surface of the pressure plate. This condition may damage the seat during inspection. Use an M6 nut as a spacer on the Force Gauge mandrel threads if required, to ensure a sub-finish surface.

5. Zero out the Force Gauge.

NOTE: Position a clean shop cloth between the Force Gauge pressure plate and the seat backrest cover.

6. While sitting in the third row rear seat, place the Force Gauge pressure plate on the upper inboard side of the second row seat backrest, 1 inch from the top and 1 inch from the side of the backrest, and apply pressure until a minimum of 850N (0.850kN) force is achieved or recliner mechanism seat back ratchets forward (If the seat back ratchets there will be an audible noise). See Figure 2.

NOTICE: Do not exceed 950N (0.950kN) force, damage to the seat back could occur.

NOTE: Zero out the Force Gauge between each measurement.



FIGURE 2



7. Was a loud ratcheting sound heard or did the seat back ratchet forward on either seat from the inboard and/or the outboard sides while applying force?

NOTE: Example video of failed recliner. 

Yes - This seat has failed inspection and will require replacement. Reference Attachment VI for repair procedure and Dealer Bulletin for parts ordering information.

No - Proceed to Step 8.

8. If the seat backrest passes the first inspection, reset the seat backrest by performing the following steps.

- a. Pull up on the manual recliner handle and fold the rear seat backrest forward. Let go of the recliner handle and position the rear seat backrest upright to the first lock position.
- b. Recline the rear seat backrest to the 2nd or 3rd recliner lock position.

9. Repeat Step 6 a second time to ensure that the seat backrest passes inspection.

NOTE: After second inspection, if recliner does not make a ratcheting sound or ratchets forward it passes inspection go to Step 10.

10. Record the highest value reached on the upper inboard second row seat backrest on repair order.



TORQUE WRENCH INSPECTION PROCEDURE

Front Seat Inboard Side - Torque Wrench Manual Backrest Recliner Inspection

NOTE: Video is available of procedure. 

1. Pull up on the manual recliner handle and fold the front seat backrest forward. Let go of the recliner handle and position the front seat backrest upright to the first lock position.
2. Recline the front seat backrest to the 2nd or 3rd recliner lock position.
3. Place hand between the headrest guide posts and give the seat back a slight shake to ensure seat latch has fully locked all the pawls prior to using the torque wrench.
4. Remove the front head restraint. See Figure 3.
 - a. Depress the locking tabs.
 - b. Remove the front head restraint.

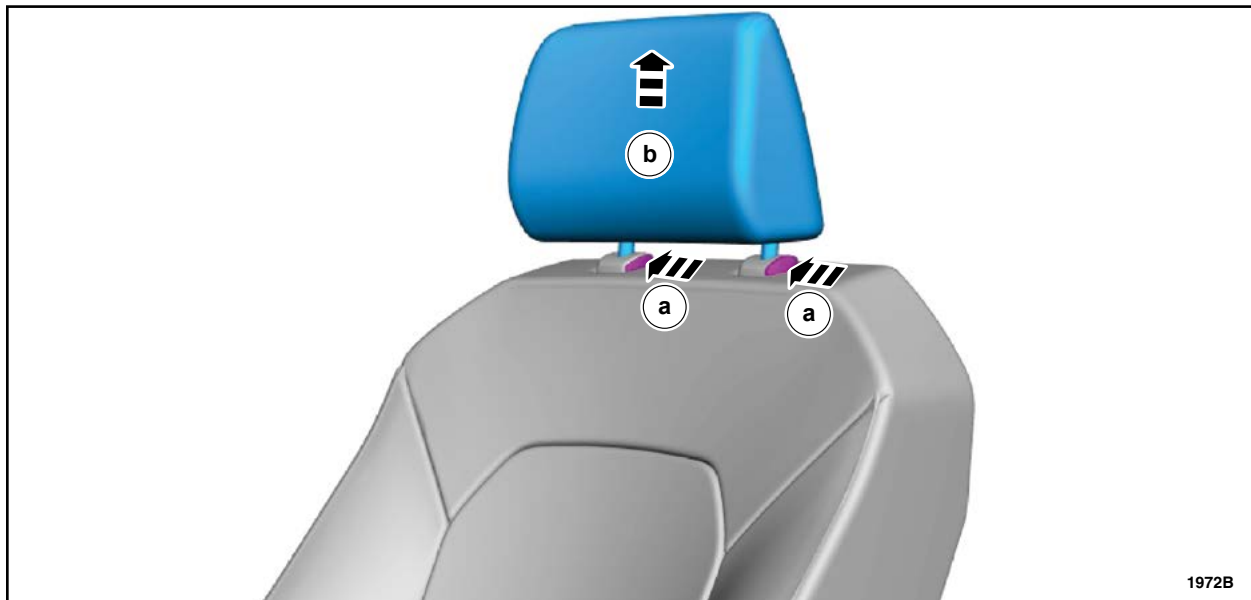

FIGURE 3



5. Partially remove the seat backrest cover enough to access the inboard seat frame holes shown in Figure 4. Please follow the Workshop Manual (WSM) procedures in Section 501-20 - Side Airbag.

- Remove the backrest cover and foam enough to allow access to the inboard seat frame.
- Removal of the front seat is not required for this procedure.
- Removal of the side airbag and nuts are not required at this time.
- Use caution during disassembly not to stretch or rip the backrest cover or backrest foam.

NOTE: Driver front seat shown, all front seats similar.

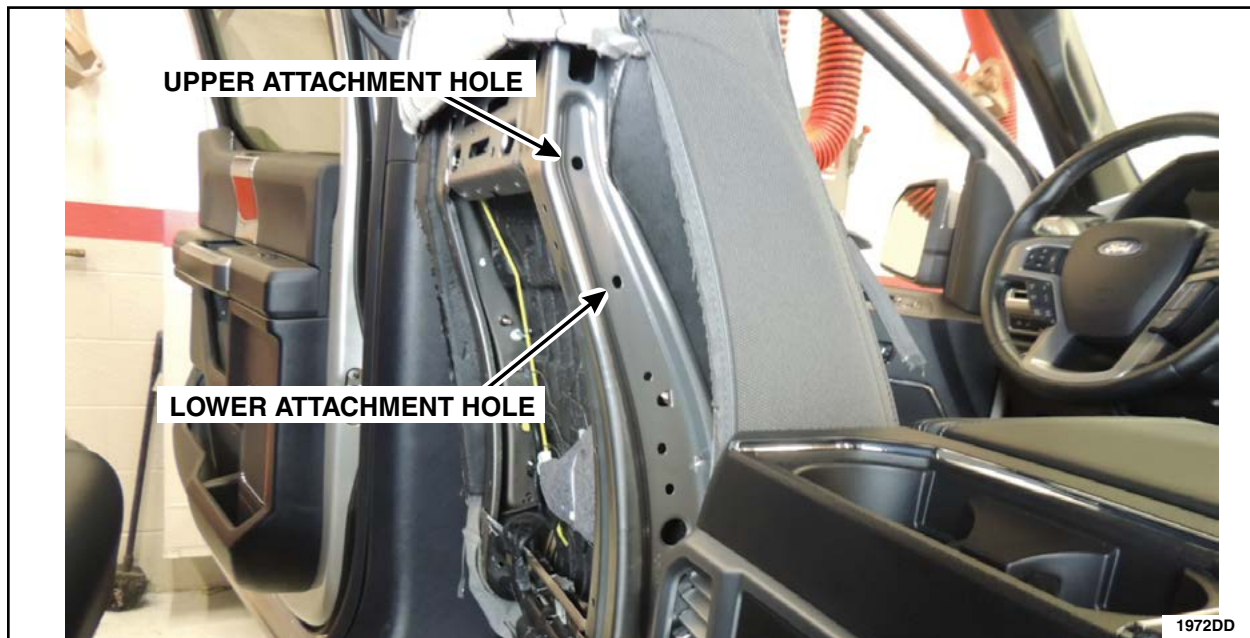

FIGURE 4



6. Measure 1.25 inches (32mm) down from the center of the upper attachment hole shown and mark frame as shown in Figure 5.



FIGURE 5



7. Install Torque Fixture onto the inboard side of the front seat backrest. See Figure 6.
 - a. Position a washer on the 6mm bolt, of suitable length, and install through the lower attachment hole.
 - b. Install a washer and nut onto the lower attachment bolt.
 - c. Position the Torque Fixture onto the lower attachment bolt between the frame and the outer washer.
 - d. Position a washer on the bolt and install through the upper attachment hole.
 - e. Install a washer and nut onto the upper attachment bolt.
 - f. Align the mark made on the backrest to the center of the Torque Fixture bolt.
 - g. Tighten down the Torque Fixture bolts and nuts so that the fixture can not move.



FIGURE 6



8. Using a 1/2 inch drive torque wrench, apply a minimum of 221 ft lbs (300 Nm) of forward force to the seat backrest, stopping when either 221 ft lbs (300 Nm) is achieved or recliner makes a ratcheting sound or ratchets forward. See Figure 7 for starting position of torque wrench.

9. Was a loud ratcheting sound heard or did the seat back ratchet forward as the force was being applied?

Yes - This seat has failed inspection and will require replacement. Reference Attachment VI for repair procedure and Dealer Bulletin for parts ordering information.

No - Proceed to Step 10.

NOTE: Example video of failed recliner. 

10. If the seat backrest passes the first inspection, reset the seat backrest by performing the following steps.

- a. Pull up on the manual recliner handle and fold the front seat backrest forward. Let go of the recliner handle and position the front seat backrest upright to the first lock position.
- b. Recline the front seat backrest to the 2nd or 3rd recliner lock positions.

11. Repeat Step 8 a second time to ensure that the seat backrest passes inspection.

NOTE: After second inspection, if recliner does not make a ratcheting sound or ratchets forward it passes inspection go to Step 12.

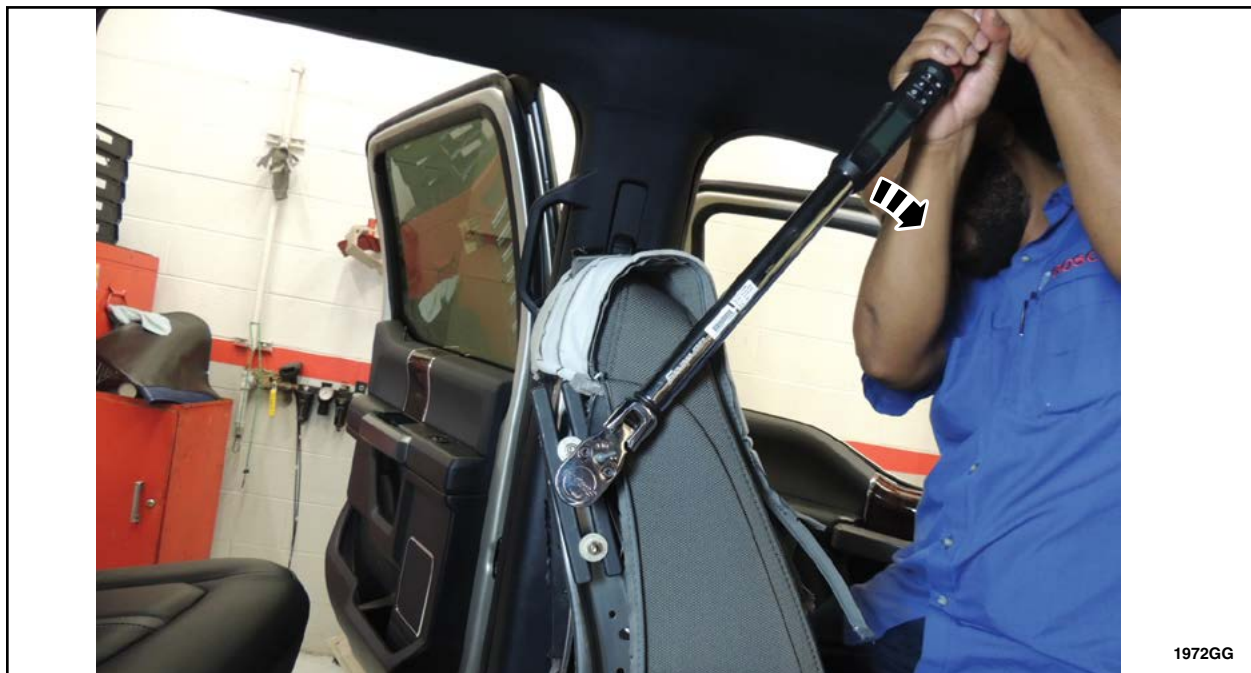

FIGURE 7



12. Remove the Torque Fixture from the inboard side of the seat backrest.

Front Seat Outboard Side - Torque Wrench Manual Backrest Recliner Inspection

IMPORTANT! This inspection procedure must be performed on front seats equipped with manual recliners for Regular Cab F150 and Regular Cab Superduty.

This inspection procedure is temporary for all other vehicles and should not be done once Force Gauges are received.

All Vehicles Except 2020 MY Explorer and Aviator Vehicles. Perform the inspection procedure on both front seats, if applicable.

1. Depower the Supplemental Restraint System (SRS). Please follow the WSM procedures in Section 501-20.
2. Remove the side airbag retaining nuts from the outboard side of the front seat backrest. See Figure 8.

NOTE: Passenger seat shown, driver seat similar.

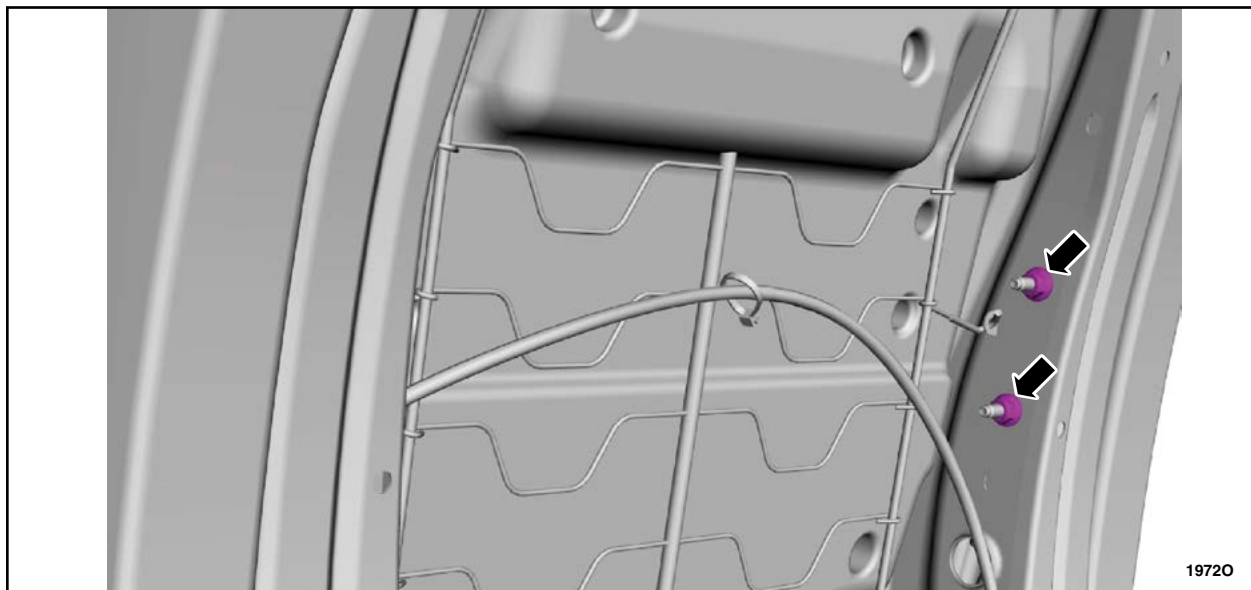

FIGURE 8



3. Guide the airbag studs out of the front seat backrest and position the seat backrest foam and the airbag toward the front of the seat to gain access to the side airbag attachment holes. See Figure 9.

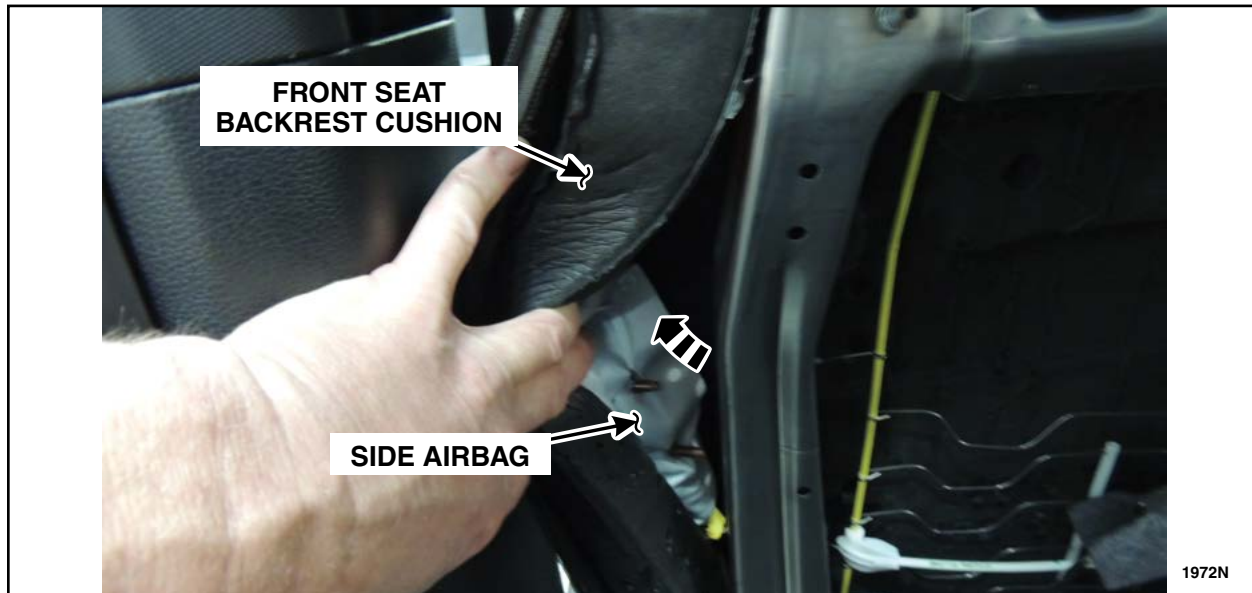

FIGURE 9

4. Measure 1.25 inches (32mm) down from the center of the upper attachment hole shown and mark frame as shown in Figure 10.

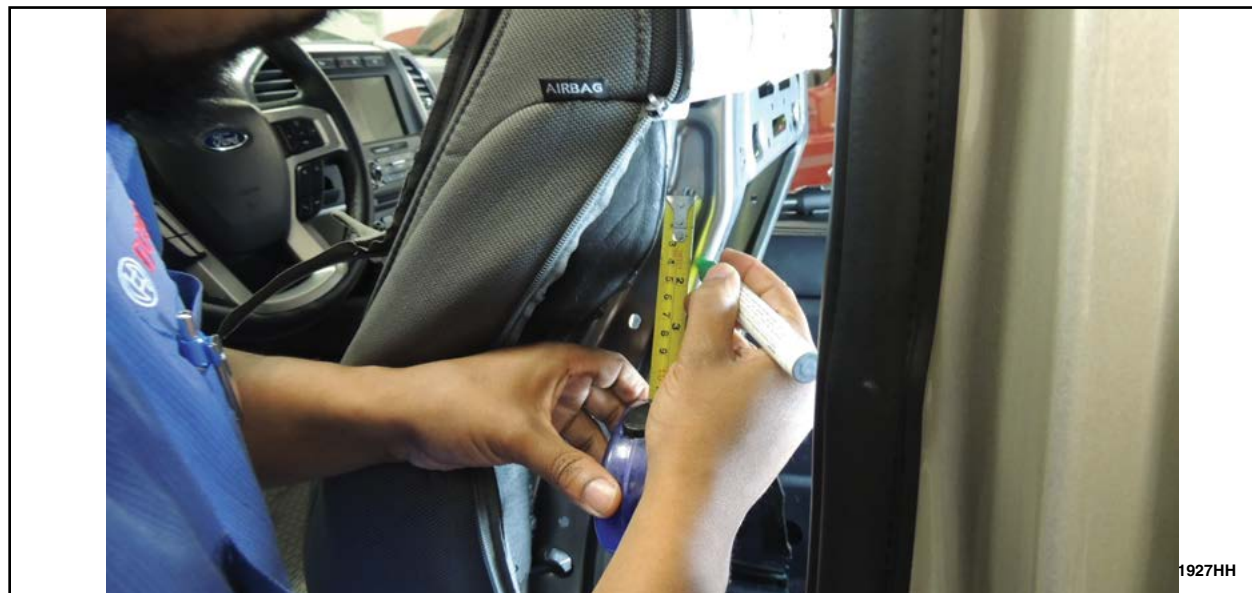

FIGURE 10



5. Install Torque Fixture onto the outboard side of the front seat backrest. See Figure 11.
 - a. Position a washer on the 6mm bolt, of suitable length, and install through the lower attachment hole.
 - b. Install a washer and nut onto the lower attachment bolt.
 - c. Position the Torque Fixture onto the lower attachment bolt between the frame and the outer washer.
 - d. Position a washer on the bolt and install through the upper attachment hole.
 - e. Install a washer and nut onto the upper attachment bolt.
 - f. Align the mark made on the backrest to the center of the Torque Fixture bolt.
 - g. Tighten down the Torque Fixture bolts and nuts so that the fixture can not move.



FIGURE 11

6. Using a 1/2 inch drive torque wrench, apply a minimum of 221 ft lbs (300 Nm) of forward force to the seat backrest, stopping when either 221 ft lbs (300 Nm) is achieved or a recliner makes a ratcheting sound. See Figure 12 for starting position of torque wrench.
7. Was a loud ratcheting sound heard or did the seat back ratchet forward as the force was being applied?

NOTE: Example video of failed recliner. 

Yes - This seat has failed inspection and will require replacement. Reference Attachment VI for repair procedure and Dealer Bulletin for parts ordering information.

No - Go to step 8.



8. If the seat backrest passes the first inspection, reset the seat backrest by performing the following steps.
 - a. Pull up on the manual recliner handle and fold the front seat backrest forward. Let go of the recliner handle and position the front seat backrest upright to the first lock position.
 - b. Recline the front seat backrest to the 2nd or 3rd recliner lock positions.
9. Repeat Step 6 a second time to ensure that the seat backrest passes inspection.

NOTE: After second inspection, if recliner passes inspection go to step 10.

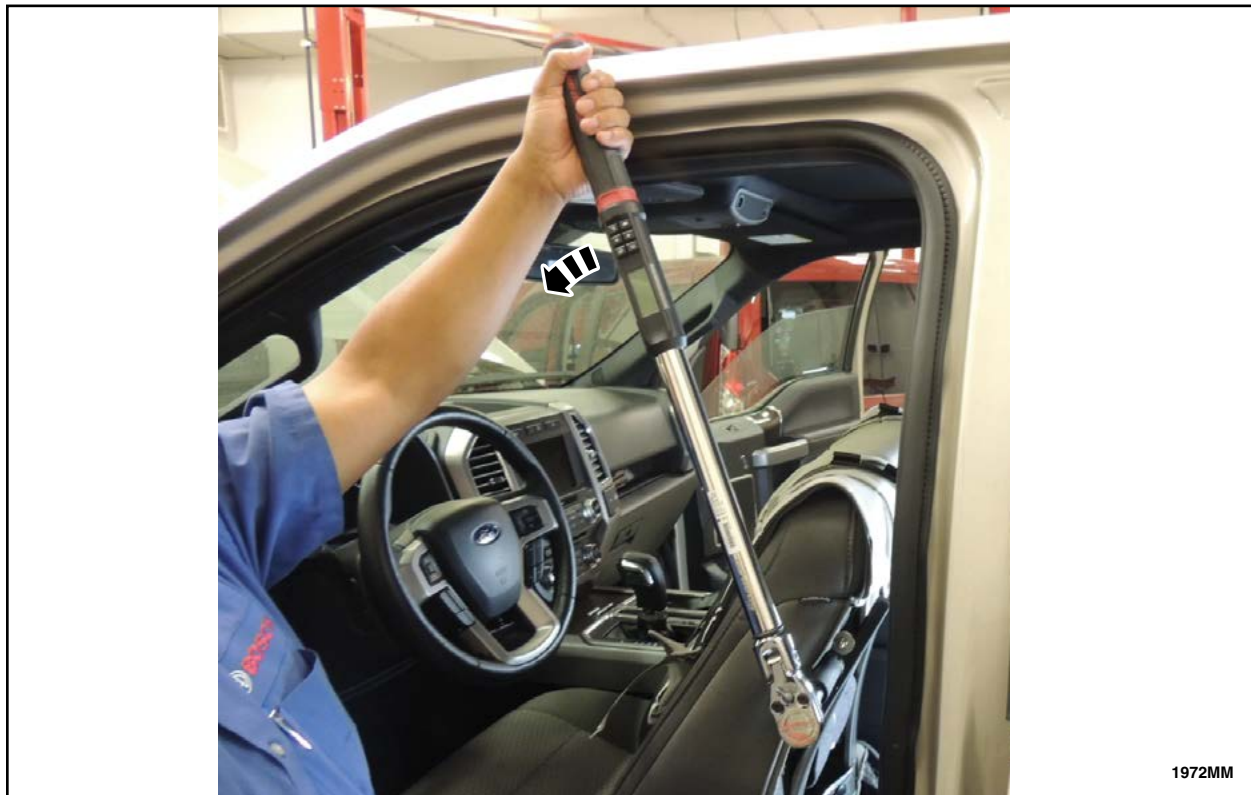

FIGURE 12

10. Remove the Torque Fixture from the outboard side of the seat backrest. Proceed to Vehicle Reassembly on Page 16.



Vehicle Reassembly

11. Position the side airbag back into position and reinstall the side airbag nuts. See Figure 8.

- Torque:
F-150 and F-Super Duty Vehicles - 55 lb.in (6.2 Nm)
Explorer Vehicles - 53 lb.in (6 Nm)
Expedition Vehicles - 55 lb.in (6.2 Nm)

12. Install the backrest cover and foam by reversing the removal procedure, refer to Step 5 on Page 8.

13. Repower the SRS. Please follow the WSM procedures in Section 501-20.

NOTE: The SRS must be fully operational and free of faults before releasing the vehicle to the customer.

2020 MY Explorer and Aviator Vehicles Only

IMPORTANT! This procedure must be performed on rear seats. Perform the inspection procedure on both second outer row seat backrests inboard sides only. This inspection procedure is temporary and should not be done once Force Gauges are received.

NOTE: Video of the procedure. [▶](#)

Second Row Outer Seat Inboard Side - Torque Wrench Manual Backrest Recliner Inspection

NOTE: Only inboard side of outer seats needs to be inspected.

1. Remove the head restraint. See Figure 13.
 - a. Depress the locking tabs.
 - b. Remove the front head restraint.

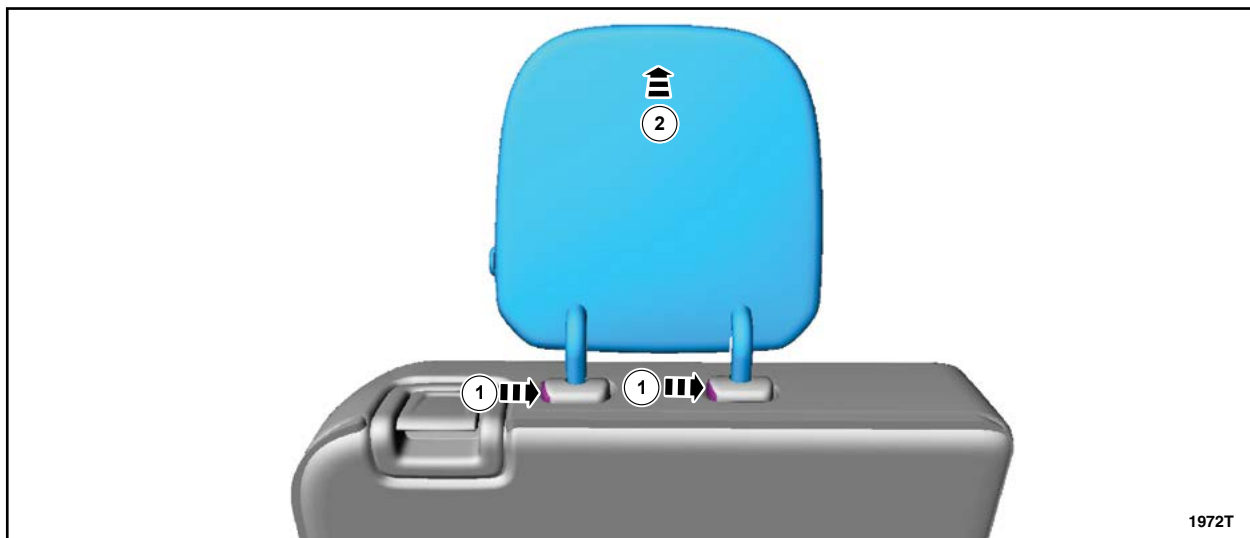

FIGURE 13



2. Partially remove the seat backrest cover enough to access the seat frame holes shown in Figure 14. Please follow the procedures within Workshop Manual (WSM) Section 501-10B - Rear Seat Backrest Cover.

- If equipped, remove the arm rest.
- Move the trim needed to position the backrest cover up and over the top of the seat backrest.
- Remove the backrest foam enough to access the seat frame.
- Removal of the head rest guide sleeves are not required for this procedure.
- Use caution during disassembly not to stretch or rip the backrest cover fabric or backrest foam.

3. The Torque Fixture will attach at the locations shown in Figure 14.



FIGURE 14



4. Measure 6.75 inches (171mm) from the top of the seat backrest frame and mark that measurement on the seat backrest lip for reference later in this procedure. See Figure 15.



FIGURE 15



5. Pull up on the manual recliner handle and move seat backrest to full recline. Position the front seat backrest upright to the first lock position.
6. Recline the seat backrest to the 2nd or 3rd recliner lock positions.
7. Place hand between the headrest guide posts and give the seat back a slight shake to ensure seat latch has fully locked all the pawls prior to using the torque wrench.
8. Install Torque Fixture onto the inboard side of the second row seat backrest. See Figure 16.
 - Position a washer on the 6mm bolt, of suitable length, and install through the lower attachment hole.
 - Install a washer and nut onto the lower attachment bolt.
 - Position the Torque Fixture onto the lower attachment bolt between the frame and the outer washer.
 - Position a washer on the bolt and install through the upper attachment hole.
 - Install a washer and nut onto the upper attachment bolt.
 - Align the mark made on the backrest to the center of the Torque Fixture bolt.
 - Tighten down the Torque Fixture bolts and nuts so that the fixture can not move.



FIGURE 16



9. Using a 1/2 inch drive torque wrench, apply a minimum of 199 ft lbs (270 Nm) of force to the seat backrest, stopping when either 199 ft lbs (270 Nm) is achieved or recliner makes a ratcheting noise or ratchets forward. See Figure 17 for starting position of torque wrench.

NOTE: The torque wrench should be positioned as close to the angle of the seat backrest as possible without touching the headliner. Place clean shop cloth over handle of torque wrench to protect headliner.



FIGURE 17

10. Was a loud ratcheting sound heard or did the seat back ratchet forward as the force was being applied to either seat backrest?

NOTE: Example video of failed recliner. 

Yes - This seat has failed inspection and will require replacement. Reference Attachment VI for repair procedure and Dealer Bulletin for parts ordering information.

No - Proceed to Step 11.

11. If the seat backrest passes the first inspection, reset the seat backrest by performing the following steps.
 - a. Pull up on the manual recliner handle and fold the front seat backrest forward. Let go of the recliner handle and position the front seat backrest upright to the first lock position.
 - b. Recline the front seat backrest to full recline.



12. Repeat Step 9 a second time to ensure that the seat backrest passes inspection.

NOTE: After second inspection, if recliner passes inspection go to Step 13.

13. Remove the Torque Fixture from the inboard side of the seat backrest.

Vehicle Reassembly

14. Reattach the seat backrest foam.

15. Position the backrest cover back down and attach the backrest cover lower J-clip.

16. Install the second row seat backrest cover child safety seat tether anchor bezel.

17. Install the head restraint.

18. Inspection complete.



CERTAIN 2018-2020 MODEL YEAR EXPLORER, F-150, F-SUPER DUTY, EXPEDITION AND AVIATOR VEHICLES EQUIPPED WITH MANUAL RECLINING SEATS

TORQUE FIXTURE FABRICATION - FOR MANUAL RECLINER SEAT INSPECTION

NOTE: The Torque Fixture for this repair is locally obtained and must be modified. There is a video for the modification of the Torque Fixture. Click here: [\[Video Icon\]](#)

- Front seats can use a 7 inch (178mm) H bar gear puller such as Pittsburgh Gear Puller Set #62958 or a 5 inch (127mm) H bar gear puller such as OEM Industrial Timing Gear Puller #27009.
- Rear seats will require a minimum of 7 inch (178mm) H bar gear puller such as Pittsburgh Gear Puller Set #62958 .

TORQUE FIXTURE FABRICATION PROCEDURE

1. Screw the bolt fully into the H bar gear puller. See Figure 1.



FIGURE 1



2. Use a cut off wheel to cut the excess bolt threads off the bottom end of the H bar tool, flush with the bottom of the H bar tool. See Figure 2.



FIGURE 2

3. Back off the bolt head 3/4 of a turn to provide room for a good weld bead on both sides of the bolt threads (top and bottom). See Figure 3.



FIGURE 3



4. Place the H bar tool in a vice. Weld bottom of the bolt threads to permanently secure the bolt in place. Ensure the weld is sufficient to withstand a large amount of torque. See Figures 4a and 4b.



FIGURE 4a



FIGURE 4b



5. Turn the H bar tool over, bolt head side up and secure in the vice. Weld bolt threads to the H bar tool to permanently secure the bolt head in place. Again ensure the weld is sufficient to withstand a large amount of torque. See Figure 5.



FIGURE 5



CERTAIN 2018-2020 MODEL YEAR EXPLORER, F-150, F-SUPER DUTY, EXPEDITION AND AVIATOR VEHICLES EQUIPPED WITH MANUAL RECLINING SEATS

FORCE GAUGE USAGE TIPS

1. Set Force Gauge to N (Newtons) or Kilonewtons (KN).
 - a. Ensure that the Force Gauge is set to N (Newtons) or KN (Kilonewtons) depending on the gauge received - Some dealers are reporting that they were unable to reach 850N (0.850kN) with the Force Gauge and the gauge was found to be set to the wrong units. Refer to the table below for conversions from Newtons to Kilonewtons to Pounds.

NOTE: Some Force Gauges will only have Kilo Newtons (kN) in which case highest reading is .850kN.

N (Newtons)	kN (Kilonewtons)	Pound-force
850N	0.850kN	191 Pound-force

- b. Some Force Gauges will require reading the included instruction manuals in order to be able to select the correct units.
2. Ensure that the force plate is contacting the seat at the top corners. If the gauge is misplaced (too far in or too low), the seat frame may not be engaged and a proper reading will be difficult to obtain. See Figure 1.

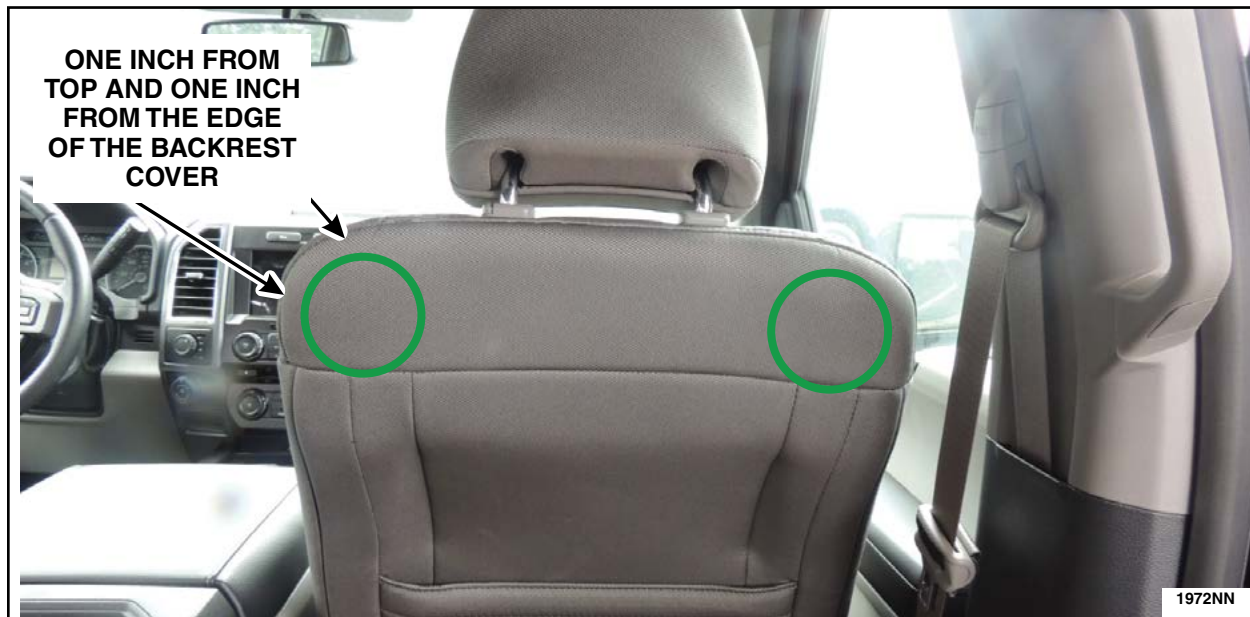

FIGURE 1



3. Multiple brands and styles of Force Gauges have been provided to dealers. Extension rods should only be used on Force Gauges that have threaded connections that are under-flush with the Force Gauge housing (currently only models Mecemesin - AFG-1000 and BFG-1000 require the use of an extension rod). See Figure 2.

NOTE: The use of extensions on the Force Gauge can contribute to a tech applying excessive side loads on the gauges. Multiple gauges have been broken due to excessive side loads.



FIGURE 2

4. Seating Position:

- a. Techs should position themselves with the front seats far enough back that their arms are not quite fully extended. They should brace themselves firmly in the seat.
- b. Dealer technicians have reported that because the F-Series Crew Cabs have the most distance between the front and 2nd row seats that it may be harder to achieve the 850N.
 - i. The front seat track can be positioned so that the reach distance while sitting in the rear seat is shortened or lengthened making it easier to achieve the 850N. If needed, a clean spacer that will not damage seat material could be positioned between the technician and the rear seat back to assist in getting the correct reach to the front seat.



5. Dealership Best Practices:

- a. Some dealer techs have fabricated simple holding fixtures that allow the tech to have better control of the Force Gauge. These holding fixtures range from a simple assembly of 2x4's to the use of C-Chanel or a small I-Beam with through holes drilled and handles welded on. See Figures 3 and 4.

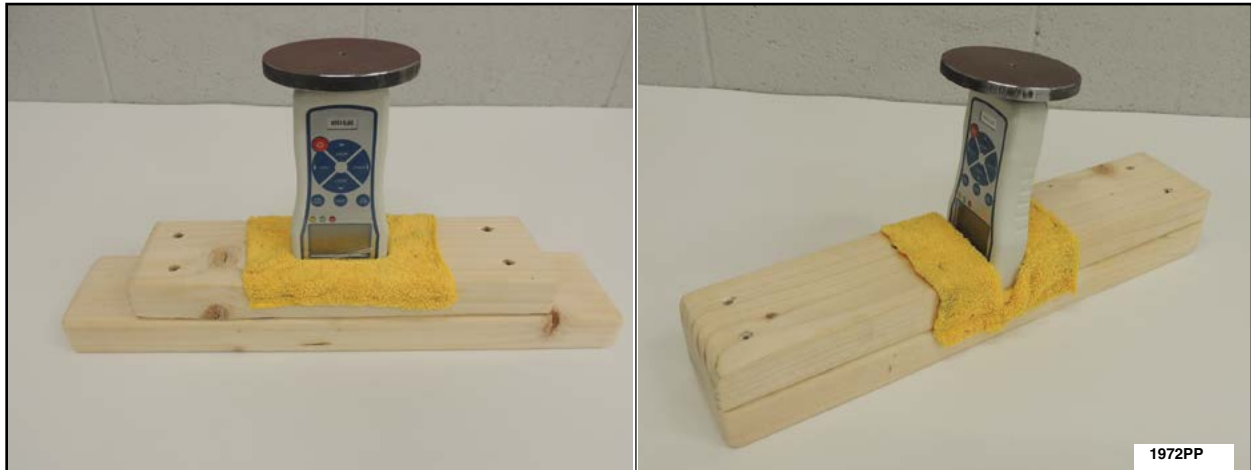

FIGURE 3



FIGURE 4



FORCE GAUGE MOUNTING LOCATION TO ASSIST IN BUILDING A HOLDING FIXTURE

NOTE: Not all force gauges are shown. Please see the user manual for the Force Gauge sent to your dealership.

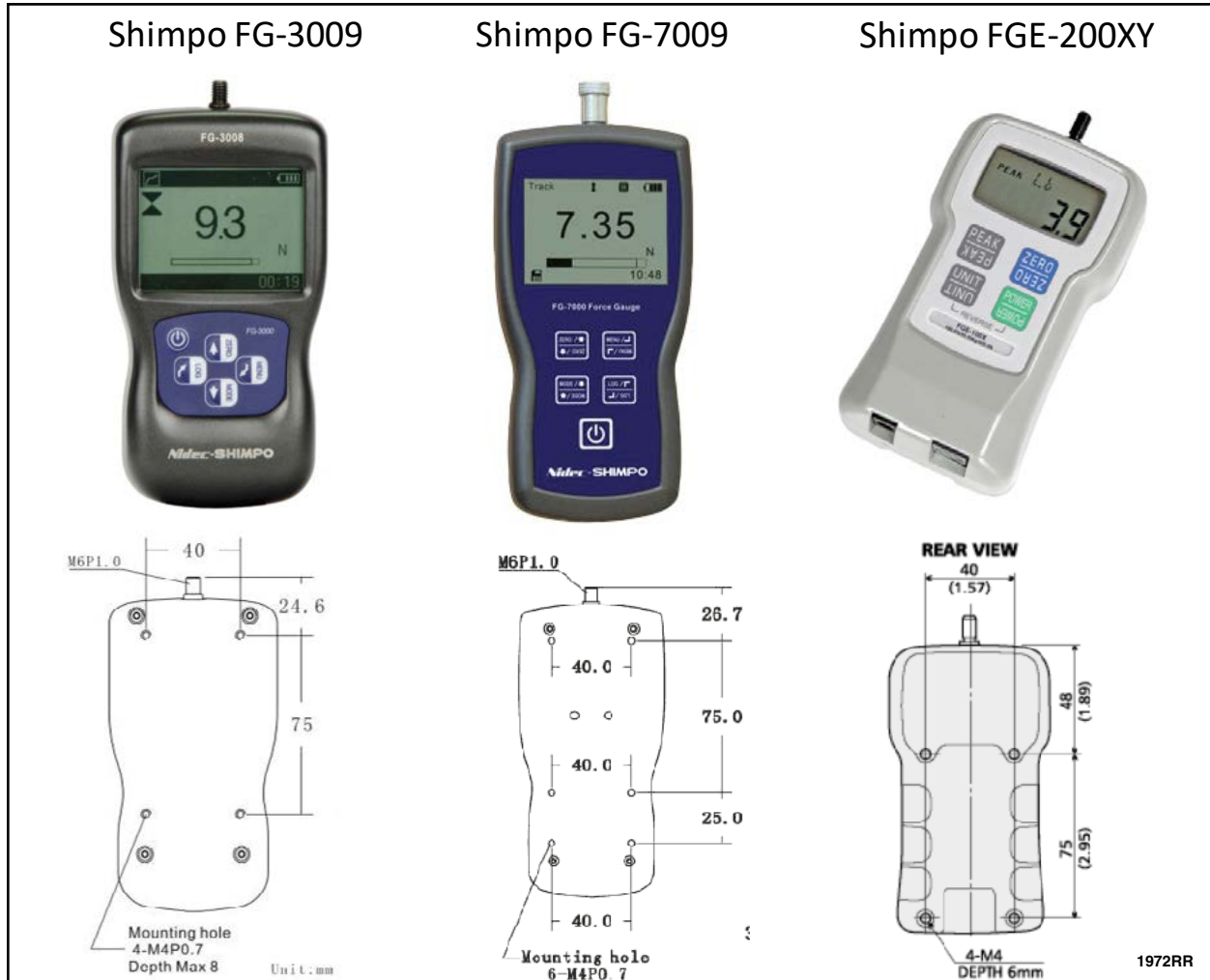
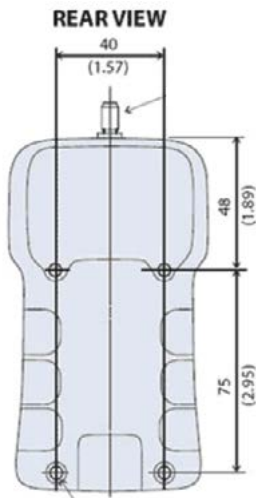

FIGURE 5



Shimpo FGV-200XY



Shimpo FGE-500HX

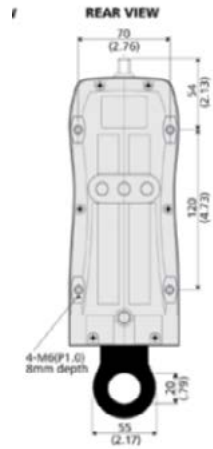

Shimpo FGV-1000HX

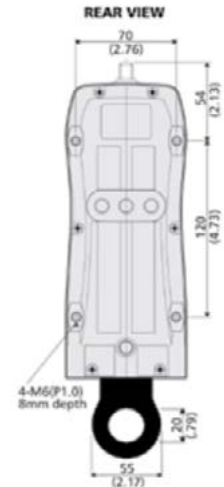

1972SS

FIGURE 6



Mark10 M5-200

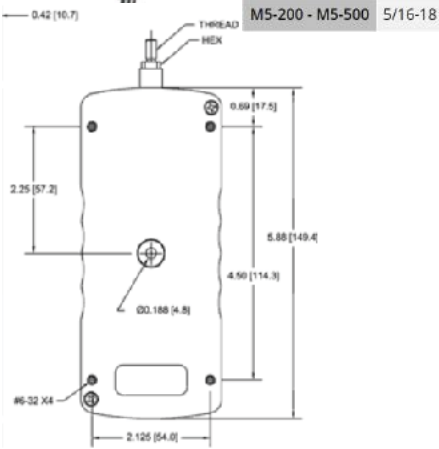

Mark10 M2-200
 (also the Checkline model)

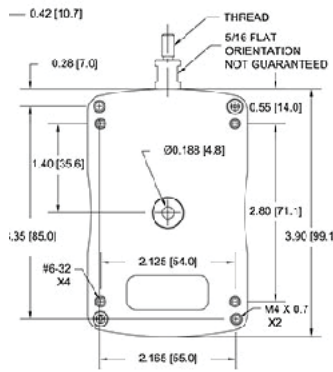

Starrett DFG-200

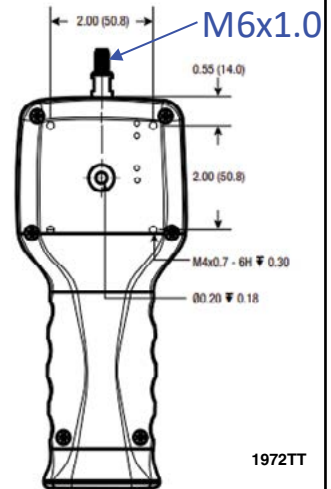
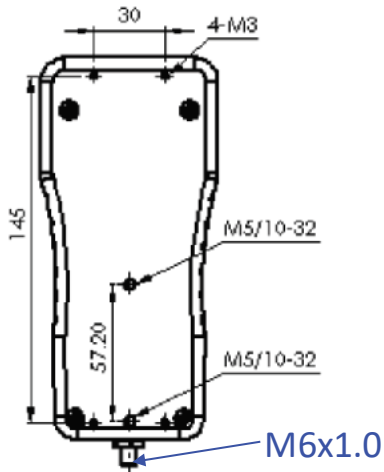

FIGURE 7



Nextech DFS-1000



Ailitech
 AFG-1000

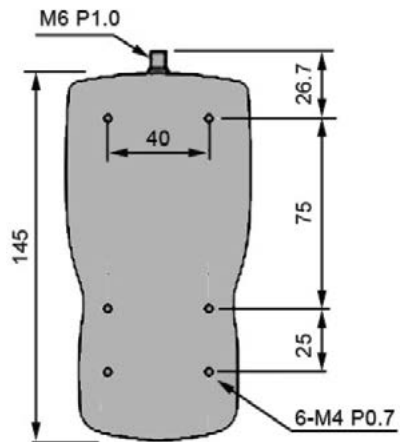

Scientific Industries
 FB900

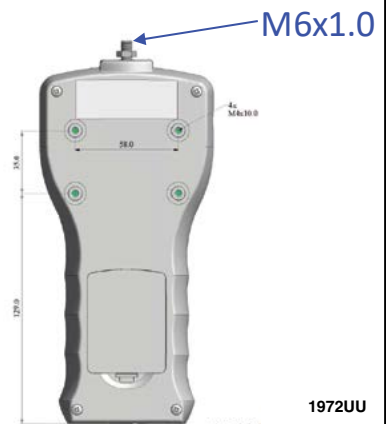
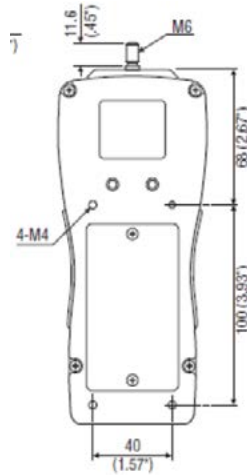

FIGURE 8



Motive
ZTA-220



1972VV

FIGURE 9



CERTAIN 2018-2020 MODEL YEAR ESCAPE, EXPLORER, F-150, SUPER DUTY, EXPEDITION AND AVIATOR VEHICLES EQUIPPED WITH MANUAL RECLINING SEATS —

OVERVIEW

Some of the affected vehicles may not conform to the requirements specified by Federal Motor Vehicle Safety Standard (FMVSS) No. 202a (Head Restraints) and FMVSS 207 (Seating Systems). The seatback may exhibit excessive movement, as a result of an improperly assembled recliner mechanism. This concern affects front row manual seat recliners on all vehicles listed except for the 2020 MY Explorer and Aviator, for which the issue pertains only to second row outboard seats. Before demonstrating or delivering any new in-stock vehicles involved in this recall, dealers are to inspect the manual recliner mechanism on front seats for the following vehicles and repair if necessary:

- 2018-2020 F-150
- 2018-2019 Explorer
- 2019-2020 Superduty, Expedition
- 2020 Escape

Before demonstrating or delivering any new in-stock vehicles involved in this recall, dealers are to inspect the manual recliner mechanism on rear seats for the following vehicles and repair if necessary:

- 2020 Explorer and Aviator

It is expected that less than 1% of vehicles will not pass the inspection, and will require part replacement. For any vehicles, which do not pass the inspection, a complete Dealer Bulletin will be provided to dealers by end of September, when it is anticipated that parts ordering information and repair instructions will be available. This service must be performed on all affected vehicles at no charge to the vehicle owner.

NOTE: This attachment is only for seat frame replacement. Seat frames should only be replaced if failure was determined by Inspection Procedure in Attachment III.



SERVICE PROCEDURE

2018-2019 MY Explorer, 2020 MY Escape, 2018-2019 MY F-150, 2019-2020 MY Expedition and Super Duty Vehicles

Front Seat Backrest Frame Replacement:

1. Replace the failed front seat backrest frame by referring to the following Workshop Manual (WSM) procedures in Section 501-10A:

- Front Seat Backrest Cover

NOTE: Do Not separate the backrest cover from the foam or remove the side airbag from the backrest cover. Remove the cover, foam and side airbag as an assembly.

- Front Seat Lumbar Assembly
- Front Seat Track Assembly
- Front Seat Backrest

2. Transfer the remaining components to the *new* seat backrest frame as necessary.

NOTE: Seat back to seat frame bolts will need to be replaced.

3. To install, reverse the removal procedures.

2020 MY Explorer and Aviator Vehicles

Second Row Single Seat Frame Assembly Replacement:

1. Replace the failed second row single seat frame assembly by referring to the following Workshop Manual (WSM) procedures in Section 501-10B:

- Second Row Single Seat Easy Entry Seat Fold Switch
- Second Row Single Seat Backrest Cover

NOTE: Do Not separate the backrest cover from the foam. Remove the cover and foam as an assembly.

- Second Row Single Seat Cushion Cover

NOTE: Do Not separate the seat cushion cover from the foam. Remove the cover and foam as an assembly.

- If equipped, Second Row Seat Cushion Blower Motor

2. Transfer the remaining components to the *new* second row single seat frame assembly as necessary.

3. To install, reverse the removal procedures.

