

Motorcycle/ATV Division

GS/GSX/GSX-R No. 250

June 17, 2019

## **SAFETY RECALL CAMPAIGN 2A90** **GSX250R/RZ/RZAL8-L9 Rear Brake Stop Lamp Switch**

**Affected Models:** 2018 - 2019 GSX250R/RZ/RZA Models

**Affected Departments:** Management, Service, Warranty, Sales, Parts, Accessories

This notice is sent to you in accordance with the requirements of the National Traffic and Motor Vehicle Safety Act.

Suzuki Motor Corporation has decided that a defect which relates to motor vehicle safety exists in certain 2018 - 2019 model-year GSX250R/RZ/RZA motorcycles.

### **STOP DELIVERY OF AFFECTED VEHICLES IMMEDIATELY**

**DO NOT SELL OR DELIVER** an affected motorcycle to a customer until you have completed or verified completion of the repair procedures outlined in this bulletin.

**It is a violation of Federal law to sell or deliver any new motorcycle or item of motor vehicle equipment subject to a safety recall campaign under a sale or lease until the defect or non-compliance has been corrected.**

**In addition, selling an unrepaired affected motorcycle is a direct violation of your Suzuki dealer agreement and may lead to additional sanctions.**

### **What is the defect?**

Water intrusion into the rear brake stop lamp switch can cause corrosion of internal parts, which can lead to the stop lamp failing to illuminate when only the rear brake is applied, or remaining illuminated continuously when the ignition is on. Failure of the stop lamp to illuminate when braking or continuous illumination of the stop lamp when the brakes are not being used increases the risk of a rear crash.

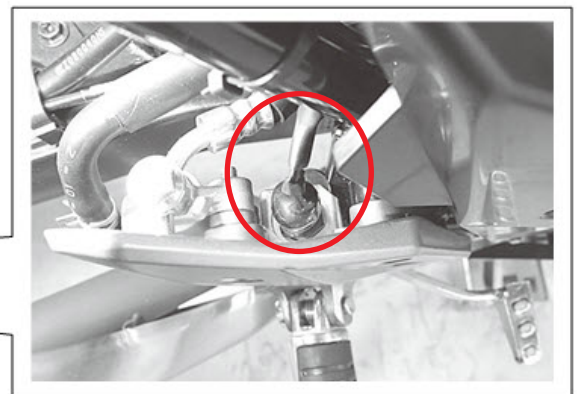
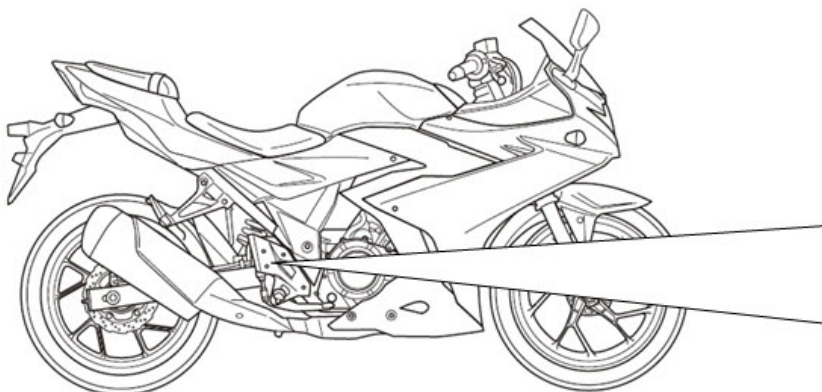

Rear Brake Stop Lamp Switch

**What your dealership will do:**

- 1) Verify the unit is affected as instructed below.
- 2) Replace the rear brake stop lamp switch assembly with the countermeasure part.
- 3) Submit a warranty claim.

<b><u>Affected Models</u></b>	<b><u>Model Year</u></b>	<b><u>VIN Range</u></b>
GSX250RL8	2018	LC6DN11A0J1100008 ~ LC6DN11AXJ1102364
GSX250RZL8	2018	LC6DN11A0J1102860 ~ LC6DN11AXJ1102915
GSX250RZL9	2019	LC6DN11A0K1100043 ~ LC6DN11AXK1100647
GSX250RZAL9	2019	LC6DN11A0K1100379 ~ LC6DN11AXK1100566

**Verify if the motorcycle is affected by the safety recall:**

Confirm the recall status by checking the vehicle identification number (VIN) against the Vehicle Master in Suzuki Connect to see if the motorcycle is eligible for the campaign inspection and replacement procedure. If you have a question regarding motorcycle eligibility, contact your Suzuki Technical Service Manager (TSM) or call Tech-Line at (714) 996-7480.

**What Suzuki Motor of America, Inc., will do:**

During the week of June 24, 2019, Suzuki Motor of America, Inc. (SMAI) will mail notifications to owners of affected motorcycles for whom we have information. The notice instructs the customer to contact a Suzuki dealer to schedule an appointment for the repair.

If you have sold an affected motorcycle to a customer prior to receiving this bulletin, please contact the customer immediately to arrange for the vehicle to be returned to your dealership for this safety recall campaign.

**Ordering parts for the Safety Recall Campaign:**

- You will be responsible for ordering parts for this recall campaign using the normal parts ordering procedure for each motorcycle.
- If you have any questions regarding your parts order, please contact National Parts Coordination at (714) 854-2165.

<b>PARTS ORDERING INFORMATION</b>			
<b>Model</b>	<b>Part Description</b>	<b>Part Number</b>	<b>Qty. Required</b>
GSX250R/RZ/RZAL8-L9	Switch Assy, Stop Lamp	37740-45DR0-RX0	1

**Early Part**

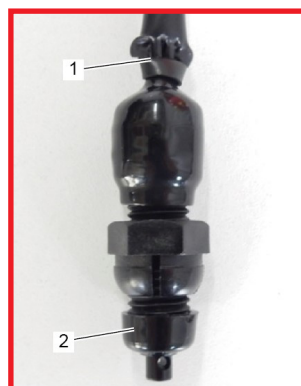

*The wiring cover (1) is crimped on the early part, and includes a cap (2) on the bottom tip.*

**New Part**

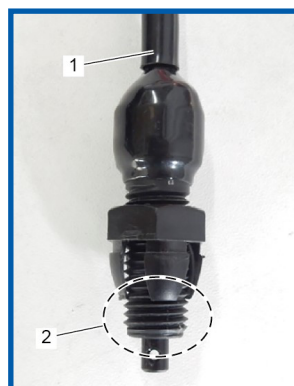

*The wiring cover (1) is not crimped on the new part, and does not include a cap (2) on the bottom tip.*

**Warranty claim processing:**

Submit a warranty claim for each recall repair immediately upon completion. This campaign requires you to file a warranty claim using ONE of the methods described below.

**Suzuki Connect Short Campaign Claim:** The short campaign claim will reimburse you for replacement of the rear brake stop lamp switch assembly and 0.6 hour labor.

<b>CAMPAIGN 2A90 GSX250R REAR BRAKE STOP LAMP SWITCH SUZUKI CONNECT SHORT FORM INSTRUCTIONS</b>	
<b>CLAIM INFORMATION:</b>	
CLAIM NUMBER:	XXXXX,X (Dealer enters number)
ENTRY TYPE:	VIN, Model/Frame or Control/Sequence # (Dealer chooses)
REPAIR DATE:	Enter date of repair
MILEAGE:	Enter mileage at repair date
CAMPAIGN NUMBER:	2A90
LABOR OPERATION:	SF9999

**Suzuki Connect Long Campaign Claim:** The Long Campaign Claim will reimburse you for the replacement rear brake stop lamp switch assembly, and additional parts and labor as authorized by your TSM.

<b>CAMPAIGN 2A90 GSX250R REAR BRAKE STOP LAMP SWITCH SUZUKI CONNECT LONG FORM INSTRUCTIONS</b>	
<b>CLAIM INFORMATION:</b>	
CLAIM NUMBER:	XXXXX,X (Dealer enters number)
ENTRY TYPE:	VIN, Model/Frame or Control/Sequence # (Dealer chooses)
REPAIR DATE:	Enter date of repair
MILEAGE:	Enter mileage at repair date
CAMPAIGN NUMBER:	2A90
<b>LABOR TIME:</b>	As authorized by your TSM
<b>PARTS INFORMATION:</b>	
ADDITIONAL PARTS:	Additional parts as authorized by your TSM
<b>AUTHORIZATION:</b>	Only needed if additional parts or labor claimed
<b>FAILURE DESCRIPTION:</b>	
DESCRIPTION OF DEFECT:	Rear Brake Stop Lamp Switch Assembly Replacement
DESCRIPTION OF REPAIR:	Performed service campaign repair per service bulletin

## **Precautions:**

- To avoid getting burned, do not touch the engine and exhaust system until they have cooled.
- Before the repair work, wash dirt from the vehicle to prevent contamination.
- When removing parts to be reused, arrange them in an orderly manner so they can be reinstalled in the proper order and orientation.
- Refer to the Service Manual for any details or procedures not mentioned in these instructions.

## **Repair Procedure:**

### **Removal:**

- 1) Remove the front seat. (Refer to section 9D Seat Removal and Installation.)
- 2) Remove the negative (-) lead wire (1) from the battery.
- 3) Remove the under center cowling. (Refer to Section 9D Under Center Cowling Removal and Installation.)
- 4) Remove the right-side cowling assemblies. (Refer to Section 9D Side Cowling / Inner Cowling / Under Cowling Removal and Installation.)
- 5) Remove the right-side under cowlings. (Refer to Section 9D Side Cowling / Inner Cowling / Under Cowling Removal and Installation.)
- 6) Remove the right-side frame side cover assemblies. (Refer to Section 9D Frame Side Front Cover / Frame Side Lower Cover / Frame Side Cover Removal and Installation.)
- 7) Disconnect the rear stop lamp switch coupler (1).

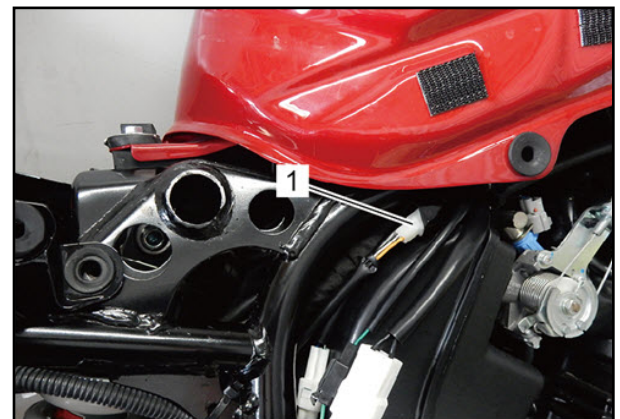
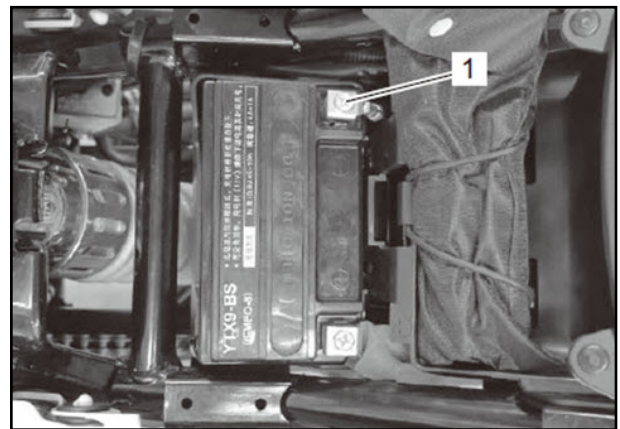



8) Remove the clamp (1).

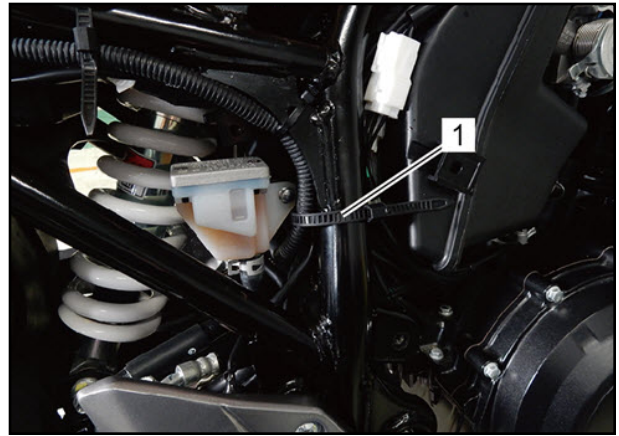

9) Remove the right-side mounting bolts (1) for the front footrest bracket.

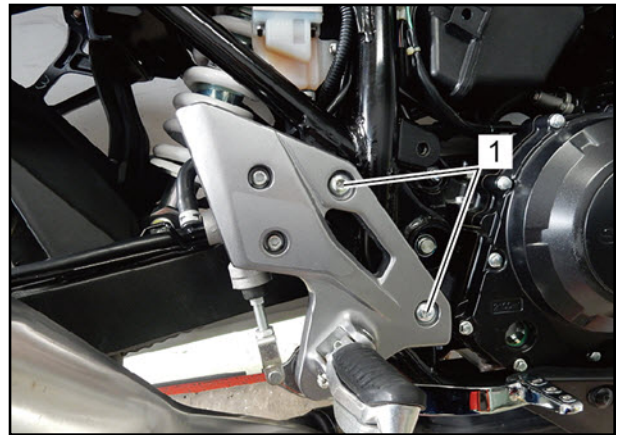

10) Loosen the adjuster nut (1) and remove the rear stop lamp switch and spring (2).

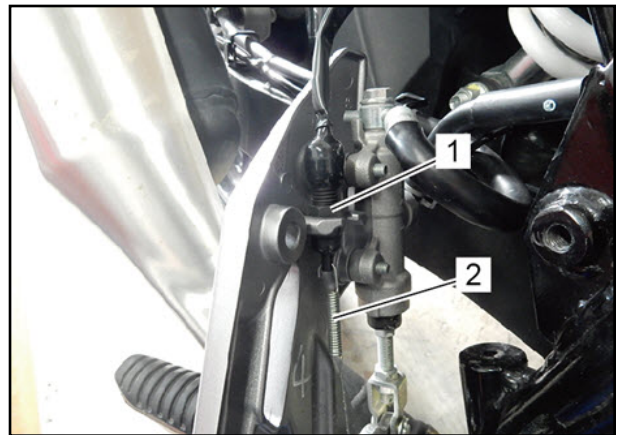

#### Installation:

1) Install the upper hook of the spring (2) on the rear stop lamp switch (1) of the countermeasure part, and secure it to the footrest bracket.

#### NOTE:

*Install the hook (A) of the spring so that it faces toward the front of the motorcycle as shown.*

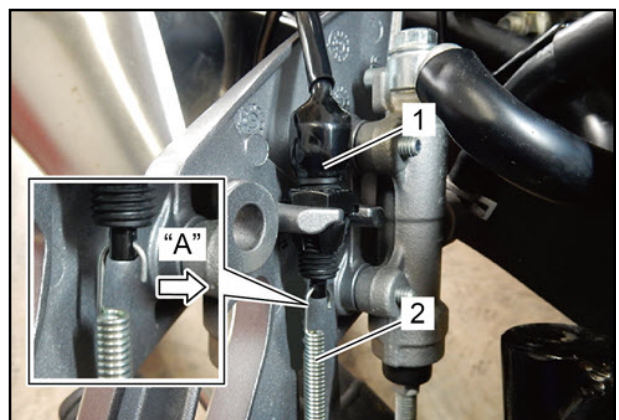

- 2) Install the lower hook (1) of the rear stop lamp switch spring on the brake pedal.

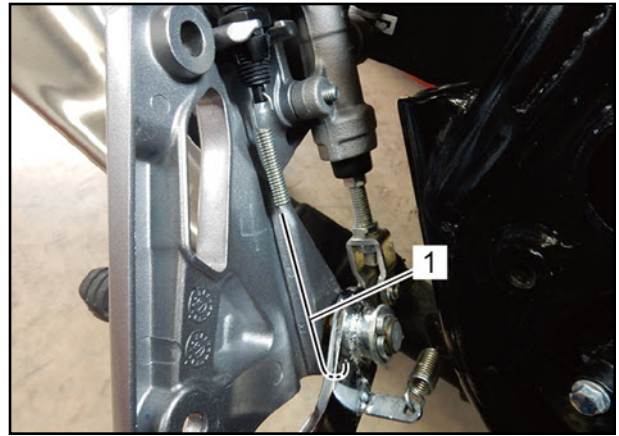

- 3) Install the front footrest assembly (1) and tighten the front footrest bracket mounting bolts (2) to the specified torque.

**Tightening torque:**

**Front footrest bracket mounting bolt (a):  
23 N·m (2.3 kgf-m, 17.0 lbf-ft)**

*(Continued on next page)*

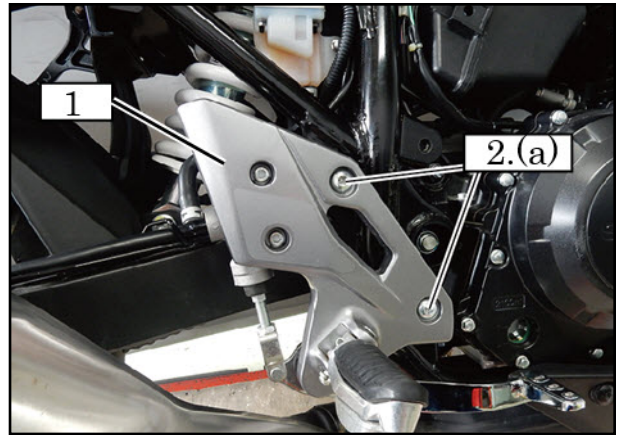



4) Install the rear stop lamp switch harness (1) and use a clamp to secure it to the following parts:

- Negative (-) battery lead wire (3)
- Side stand switch lead wire (4)
- Starter motor lead wire (5)
- Tip-over sensor lead wire (6)
- Generator lead wire (7)

#### Inside the Frame

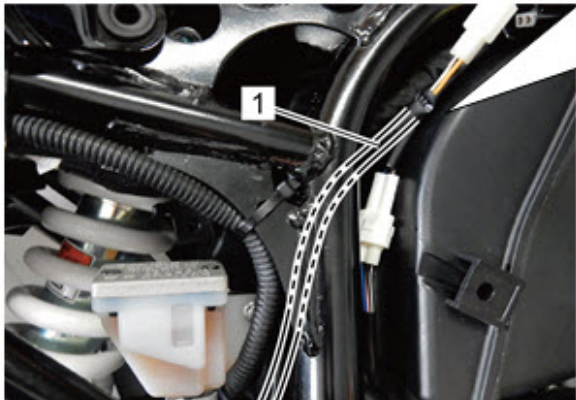
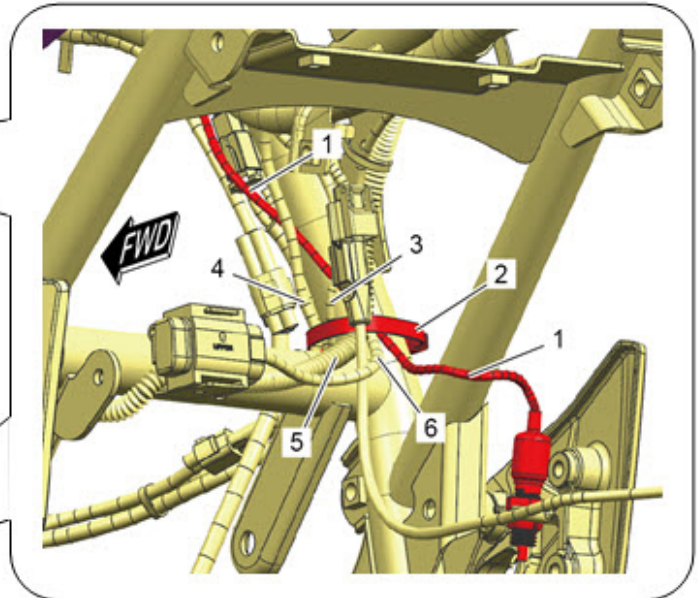
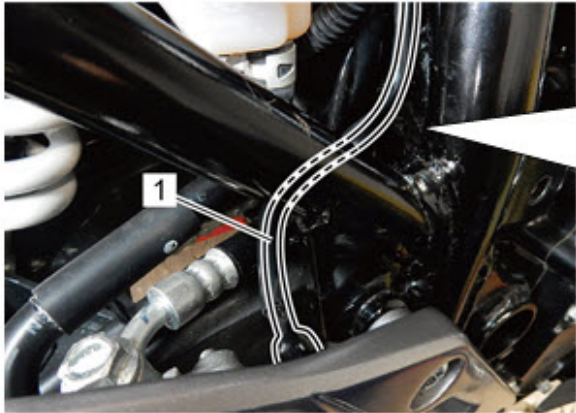

#### Outside the Frame

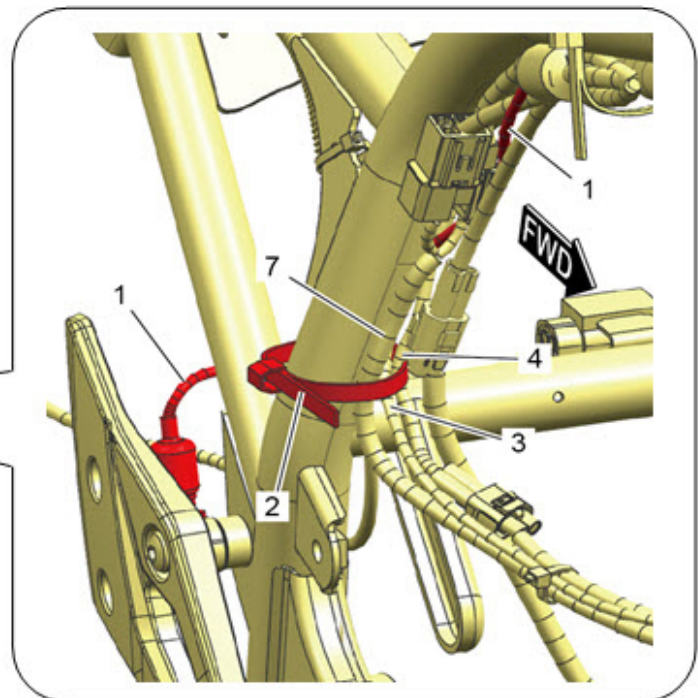
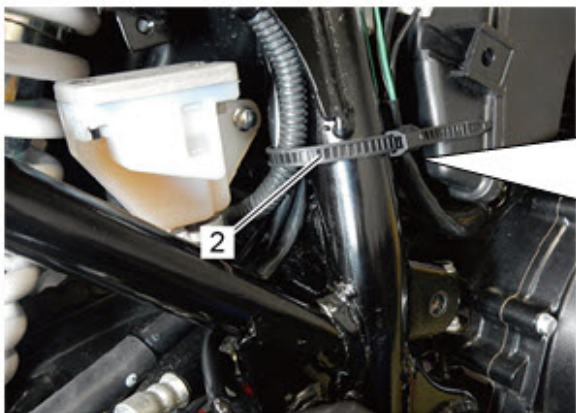

- 5) Connect the rear stop lamp switch coupler (1).

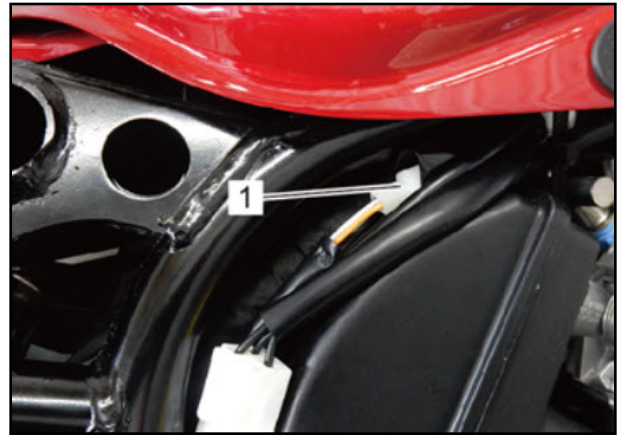

- 6) Confirm the rear stop lamp switch turns on just before you feel pressure when pushing down on the rear brake pedal. Make any necessary adjustments by turning the adjuster nut (1) in or out while holding the pedal.
- 7) Install the side frame side cover assemblies. (Refer to Section 9D Frame Side Front Cover / Frame Side Lower Cover / Frame Side Cover Removal and Installation.)
- 8) Install the side under cowlings. (Refer to Section 9D Side Cowling / Inner Cowling / Under Cowling Removal and Installation.)
- 9) Install the side cowling assemblies. (Refer to Section 9D Side Cowling / Inner Cowling / Under Cowling Removal and Installation.)
- 10) Install the under center cowling. (Refer to Section 9D Under Center Cowling Removal and Installation.)
- 11) Connect the negative (-) battery lead wire to the battery.
- 12) Install the front seat. (Refer to Section 9D Seat Removal and Installation.)
- 13) Confirm each part is properly installed and secured, confirm the rear stop lamp turns on properly, and reset the clock on the instrument panel. (Refer to page 3-9 of the Owner's Manual.)

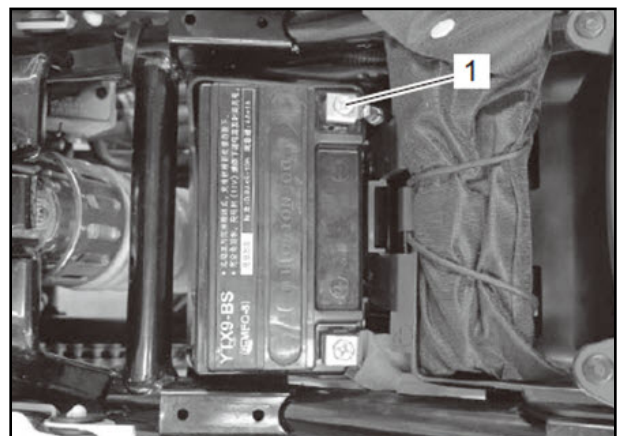
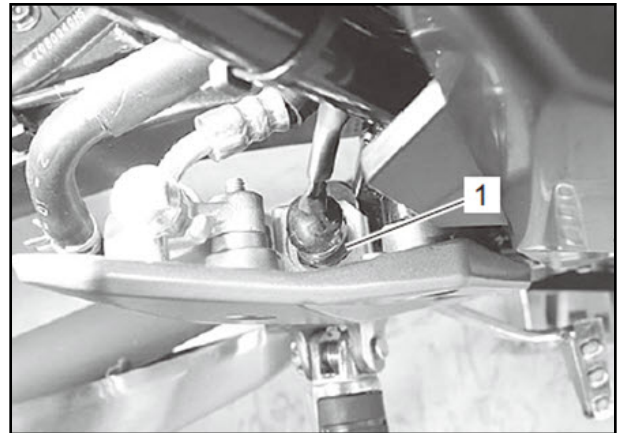





SUZUKI MOTOR OF AMERICA, INC.

## IMPORTANT SAFETY RECALL

This Notice Applies to Your Suzuki Vehicle Identification Number (VIN)

June 28, 2019

Dear Suzuki Owner:

This notice is sent to you in accordance with the requirements of the National Traffic and Motor Vehicle Safety Act.

Suzuki Motor Corporation has decided that a defect which relates to motor vehicle safety exists in certain 2018 - 2019 model-year GSX250R/RZ/RZA motorcycles.

### **What is the defect and what will your dealership do to correct it?**

Water intrusion into the rear brake stop lamp switch can cause corrosion of internal parts, which can lead to the stop lamp failing to illuminate when only the rear brake is applied, or remaining illuminated continuously when the ignition is on. Failure of the stop lamp to illuminate when braking or continuous illumination of the stop lamp when the brakes are not being used increases the risk of a rear crash.

Your Suzuki dealer will install an improved rear stop lamp switch assembly. This procedure will take approximately one hour to complete. Parts are available now, and there will be no charge to you for any recall service-related parts or labor.

### **⚠ WARNING**

**Operating your motorcycle without having the recall service performed increases the risk of a rear crash.**

#### **To minimize the risk of a crash:**

- **Please do not ride nor allow anyone else to ride your motorcycle until this recall service has been completed.**
- **If you must ride your motorcycle before this safety recall service has been completed, check the stop lamp and other items for proper operation as outlined in the "INSPECTION BEFORE RIDING" checklist in section 4 of your owner's manual before each ride.**
- **Be aware that the stop lamp may not illuminate if you use only the rear brake pedal. Apply the front and rear brakes together as outlined in your owner's manual.**

### **What you should do:**

Make sure you are prepared for the recall service by taking the following steps:

- Contact your dealer as soon as possible to make an appointment for the recall service. Be prepared to provide them with the VIN of your motorcycle (provided at the top of this notice).
- Please take this notice to your dealer to help your dealer process your claim.

### **What to do if you receive this notice in error:**

This notice was mailed to you according to the latest information that is available to us. If you no longer own the Suzuki motorcycle described in this notice, please complete and return the attached Change of Address/Ownership card to Suzuki Motor of America, Inc., and forward this recall information to the current owner (if known).

Federal regulations require that any vehicle lessor receiving this recall notice must forward a copy of this notice to the lessee within ten days.

**Customer reimbursement for prior repairs related to this safety recall:**

If your motorcycle is included in this recall and you have paid for repairs to address failure of the rear brake stop lamp switch due to corrosion of internal parts, you may be eligible for full or partial reimbursement. Please note the following conditions for reimbursement:

- Only repairs made to address the defects that led to this recall are reimbursable. Additional expenses such as towing, car rental, accommodations, damage repairs, etc., will not be reimbursed. Reimbursement will not be provided for routine scheduled maintenance.
- Reimbursement may be limited to the suggested list price for parts, the Suzuki published flat-rate time allowance for the repair, and the labor rate that an authorized Suzuki dealer in the same area would charge for the same repair.
- An owner will not be eligible for reimbursement if the expenses for repairs are incurred more than 10 days after the date of this notice.
- Reimbursement claims may also be excluded when adequate documentation is not submitted by the claimant. This includes a proof of ownership, a repair order, and proof of payment for the repair.

- To apply for reimbursement:
- 1) Go to [www.suzukicycles.com](http://www.suzukicycles.com).
  - 2) Select Safety Recalls at the lower right side of the home page.
  - 3) When the page refreshes, select Recall Notification Letters.
  - 4) Select *GSX250R Rear Brake Stop Lamp Switch Replacement Reimbursement*.

**Who to contact if you experience problems:**

Your Suzuki dealer can provide you the fastest response to your questions or concerns about this safety recall campaign. If you have any difficulty with this recall campaign, you may contact the Suzuki Motor of America, Inc., Customer Service Department for assistance at (714) 572-1490 during the hours of 7:00 AM to 4:30 PM Pacific Time. Please have your vehicle identification number (VIN) ready when calling.

If you need to locate your nearest Suzuki Motorcycle Dealer, please visit [www.suzukicycles.com](http://www.suzukicycles.com) and click on the "FIND A DEALER" tab, which is located in the upper right corner of our website.

If you believe that Suzuki Motor of America, Inc., has failed to provide the safety recall campaign service without charge or is unable to do so within a reasonable time, you may submit a complaint to the Administrator of the National Highway Traffic Safety Administration, 1200 New Jersey Ave., S.E., Washington D.C., 20590 or call the toll-free Vehicle Safety Hotline at 1-888-327-4236 (TTY: 1-888-424-9153) or go to [www.safercar.gov](http://www.safercar.gov).

We apologize for any inconvenience this recall campaign causes you. We hope you understand that your safety and satisfaction are important priorities for us.

Sincerely,

Suzuki Motor of America, Inc.