

- ATTENTION:**
- GENERAL MANAGER
 - PARTS MANAGER
 - CLAIMS PERSONNEL
 - SERVICE MANAGER

IMPORTANT - All Service Personnel Should Read and Initial in the boxes provided, right.

©2018 Subaru of America, Inc. All rights reserved.



QUALITY DRIVEN® SERVICE

PRODUCT CAMPAIGN BULLETIN

APPLICABILITY: 2012-14MY Impreza 2.0
2013MY Crosstrek
2013MY BRZ

NUMBER: WTY-84

DATE: 01/04/19

NHTSA ID: 18V-722

SUBJECT: 2.0L Engine Valve Spring Fracture May Cause Engine Stall

INTRODUCTION:

Subaru of America, Inc. (Subaru) is recalling certain 2013 model year BRZ and XV Crosstrek and 2012-2014 model year Impreza vehicles to replace the engine valve springs which may fracture. A total of 139,324 U.S. vehicles will be affected by this recall.

AFFECTED VEHICLES:

Model Year	Carline	Production Range
2013	BRZ	12/09/2011 - 07/02/2013
2013	XV Crosstrek	05/17/2012 - 07/02/2013
2012-2013	Impreza	01/17/12 - 06/13/2013
2014	Impreza	10/3/2013

Coverage for all affected vehicles must be confirmed by using the Vehicle Coverage Inquiry function on subarunet.com.

PART INFORMATION:

To simplify the ordering procedure, parts to complete this recall have been made available in “kit” form:

Description	Part Number	Application
SPRING-VALVE EG KIT	X1321AA140 (for FB Engines)	IMPREZA / CROSSTREK
	X1321AA110 (for FA Engines)	BRZ
GASKET-EXHAUST PIPE R	44011AG000	

Continued...

CAUTION: VEHICLE SERVICING PERFORMED BY UNTRAINED PERSONS COULD RESULT IN SERIOUS INJURY TO THOSE PERSONS OR TO OTHERS.

Subaru Service Bulletins are intended for use by professional technicians ONLY. They are written to inform those technicians of conditions that may occur in some vehicles, or to provide information that could assist in the proper servicing of the vehicle. Properly trained technicians have the equipment, tools, safety instructions, and know-how to do the job correctly and safely. If a condition is described, DO NOT assume that this Service Bulletin applies to your vehicle, or that your vehicle will have that condition.

Subaru of America, Inc. is ISO 14001 Compliant

ISO 14001 is the international standard for excellence in Environmental Management Systems. Please recycle or dispose of automotive products in a manner that is friendly to our environment and in accordance with all local, state and federal laws and regulations.

DESCRIPTION OF THE ISSUE AND SAFETY RISK:

The engine valve springs may fracture, which may cause an abnormal noise or engine malfunction. This may result in the engine stalling during driving and the driver may be unable to restart the vehicle. An engine stall while driving could increase the risk of a crash.

DESCRIPTION OF THE REMEDY:

The engine valve springs will be replaced with new ones having improved durability strength. Special tools will be available to assist in making these repairs. Each retailer will be provided with these tools free of charge. See below for details.

RETAILER RESPONSIBILITY:

Please be advised that it is a violation of Federal law for a Retailer to deliver a new motor vehicle covered by a recall under a sale or lease until the defect is remedied. Therefore, any Authorized Subaru Retailer failing to perform the applicable service procedures to correct all affected vehicles in their inventory prior to the vehicle being placed in service may be subject to civil penalties of up to \$6,000 per violation (i.e., for each vehicle), as provided in 49 CFR §578.6 and will also be in breach of the Subaru Retailer Agreement.

Retailers are to promptly perform the applicable service procedures to correct all affected vehicles in their inventory. Additionally, whenever a vehicle subject to this recall is taken into inventory or in for service, necessary steps should be taken to ensure the recall correction has been made before selling or releasing the vehicle.

Please refer to Section 8.4.7 of the Subaru Claims Policies & Procedures concerning Alternate Transportation Program eligibility and third-party rental reimbursement rates.

OWNER NOTIFICATION:

Subaru will notify affected vehicle owners by first class mail on December 28, 2018. A copy of that owner notification letter is included at the end of this bulletin.

RETAILER AFFECTED VIN LISTS:

Each Subaru retailer will receive an affected VIN list from their Zone Office when owner notification begins. Vehicles will be assigned to retailers in the affected VIN list as follows:

- Original vehicle owners are assigned to the original selling retailer when their current address is within a 100-mile radius of that retailer.
- If the original selling retailer is inactive, the VIN has been assigned to the nearest active retailer.
- For any new owners or when original owners live more than 100 miles from the original selling retailer, the VIN has been assigned to the nearest active retailer.

IMPORTANT: Retailer affected VIN lists include information for vehicles affected by this recall. This information will enable retailers to follow up with owners of affected vehicles. The lists contain owners' names and phone numbers obtained from State Motor Vehicle Registration Records. The use of such motor vehicle registration data for any other purpose is unlawful. Accordingly, retailers are required to limit the use of these lists for the sole purpose of completing this recall.

Continued...

PARTS INFORMATION:

To help improve efficiency when performing this campaign, part “kits” have been established for both the FA and FB engines. They include the new valve springs along with all the necessary gaskets and seals to do the repair (except for FA engines as noted below). The kits are the same for manual and automatic / CVT models.

- P.n. **X1321AA110** is for FA engines
IMPORTANT NOTE: for FA engines only, p.n. **44011AG000**, qty. 1, EXHAUST PIPE GASKET R is also required for this repair and is NOT included in the parts kit.
- P.n. **X1321AA140** is for FB engines.

SERVICE PROCEDURE / INFORMATION:

REMINDER: Customer satisfaction and retention starts with performing quality repairs.

IMPORTANT NOTES: The service procedures for the steps involving valve spring replacement have been revised for this Product Campaign. These specific procedures, involve the use of a set of special tools, carefully designed to help Technicians perform this campaign with increased efficiency while reducing the amount of engine disassembly. Proper use of these special tools is critical to achieve the required results. Some portions of the overall procedure (e.g. engine assembly removal and reinstallation) are unchanged. For those portions of this procedure, always refer to the applicable Service Manual and review the full requirements of the steps being performed. The Service Manual procedures contain information critical to performing an effective repair the first time and every time. This includes but is not limited to: important SAFETY precautions, proper inspection criteria, other necessary special tools and required processes needed for a complete and lasting repair.

The Service Procedure for this campaign will be divided into 3 sections:

- **Section 1:** Special Tools
- **Section 2:** Valve Spring replacement for 2.0L “FA” engine used in BRZ
- **Section 3:** Valve Spring replacement for 2.0L “FB” engines used in Impreza and Crosstrek.

The major differences between procedures can be summarized as follows:

For FA engine:

- Timing cover, timing chain, camshaft (and related components) removal is required for access.
- The valve spring replacement tools consist of one remover and one installer.

Continued...

For FB engine:

- Timing cover (and related components) removal is **NOT** required for access.
- The valve spring replacement tools consist of a set of four different spring compressor tools, two retainer / keeper re-installation tools and a “bridge” framework to properly position each tool.

Both the FA and FB procedures require removal of the engine assembly.

NOTE: If the engine has been removed from the vehicle for any warrantable concern in addition to performing WTY-84, see the **CLAIM REIMBURSEMENT AND ENTRY PROCEDURES** section on pg. 28 for instruction on how to properly submit the claim.

Section 1- SPECIAL TOOLS:

The following provides information and photos of the special tools designed to help Technicians perform this campaign smoothly and efficiently:

- **Engine Stand**, p.n. 99850AA050



- **Air Hose Assembly**, p.n. 99850AA010 includes: air pressure regulator, 2 spark plug adapters, air hose w/ “Y” connector, 2 spark plug adaptor quick-connectors and main shut-off valve. This tool is used on both FA and FB engines.



Continued...

- **Valve Spring Replacement Tool Set**, p.n. 99850AA000 (for use on FA engines **ONLY**)

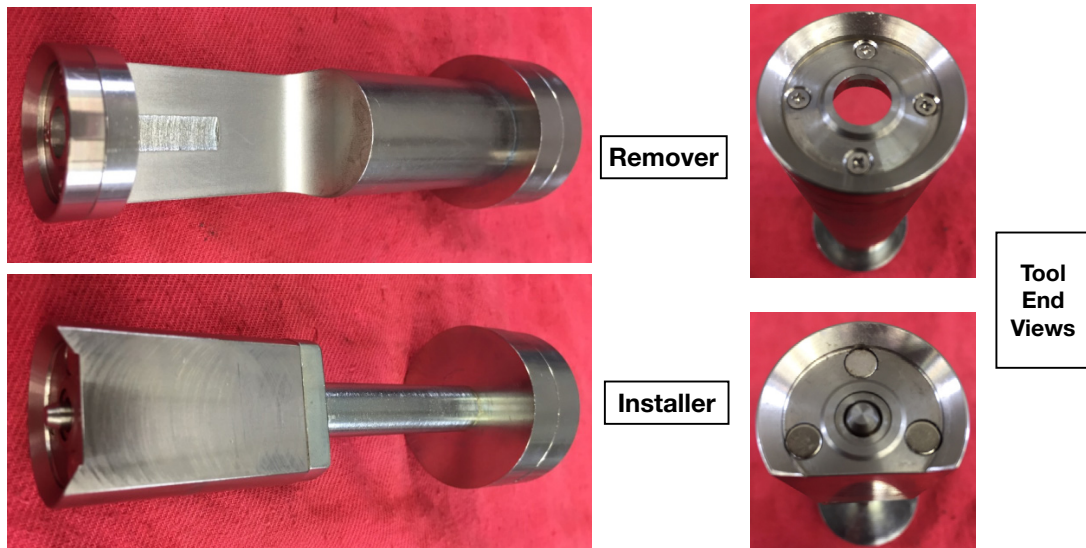

- **Bridge Base and Bracket Set**, p.n. 99850AA020 (for use on FB engines **ONLY**)



- **Valve Spring Compressor and Installation Tool Set**, p.n. 99850AA030 (for use on pre-2015MY FB engines **ONLY**).
NOTE: The tools for servicing the **INTAKE** valves have **WHITE** paint markings whereas the tools for servicing the **EXHAUST** valves have **GREEN** paint markings.

Valve Spring Compression Tool (2.0/2.5 IN-A)	Valve Spring Remover Tool (2.0/2.5 IN-B)	Valve Spring Installer Tool (2.0/2.5 IN-C)
Valve Spring Compression Tool (2.0/2.5 EX-A)	Valve Spring Remover Tool (2.0/2.5 EX-B)	Valve Spring Installer Tool (2.0/2.5 EX-C)

Continued...

VERY IMPORTANT: When using the above spring compressor and installation tools, use **ONLY** the tool specified for the specific task being performed. **NEVER ATTEMPT TO USE THESE FB-SPECIFIC TOOLS TO PERFORM THIS PROCEDURE ON A FA ENGINE** (to avoid removing the front cover and camshafts) **OR A 2015MY or later FB ENGINE AS DOING SO WILL SEVERELY DAMAGE THEM.** Although some of these tools look very similar to each other, there are significant design differences in each which make them specific for each function. This is why they have the paint markings and alpha-numeric identification information etched onto them. More detail on each tool's specific function will be provided later in this bulletin.

Section 2: FA Engine Procedure:

TIPS:

- Road test the vehicle before disassembly to confirm the engine operates as designed with no abnormalities (e.g. smoke from exhaust, engine noise, fluid leak(s), A/C system operation, etc.).
- Check for any DTC(s).
- Check for any vehicle modifications and if found, document them using the existing process outlined in the Claims Policies and Procedures section **8.4.45** "Procedures for Assessment, Documentation, and Notification of Non-Warrantable Repairs" using the "Vehicle Modification and Accident Damage Report" found on Subarunet under Service-Technical / Forms / Downloads.
- Note and review any items needing attention with the customer before proceeding. Having the customer initial these item by item on the repair order is highly recommended.
- Contact the SOA Techline immediately to review any concerns believed to be impeding or preventing proper completion of this recall. There should be very few if any cases where this would be necessary. A severe example of an impediment would be if the wrong specification engine is found to be installed. Nearly all aftermarket modifications can be worked around or removed to allow valve spring replacement to proceed.
- Contact the SOA Claims Team should removal and / or reinstallation of these customer modifications require significant additional time.
- Open both door windows before disconnecting the battery to avoid weatherstrip damage.
- Remove the fuel pump fuse, then start and run the vehicle until it stalls to relieve fuel pressure.
- Remove the fuel cap to release any vapor pressure inside the fuel tank and to prevent fuel spray when disconnecting fuel lines.
- Record the customer's radio station presets (and Navigation System Favorites if applicable) then disconnect the battery negative cable from the battery terminal.
- Separate the exhaust manifold assembly from the front exhaust pipe and remove the manifold from the vehicle. The manifold to cylinder head gaskets are included in the parts kit but the front pipe gasket, p.n. 44011AG000 as mentioned in the Parts Information section is not.
- Evacuate the A/C system and leave the A/C compressor assembly bolted to the engine. Remove both lines from the compressor. Always protect any exposed connections from contamination while the system is open.
- Drain the engine oil and coolant.

Continued...

- 1) Remove the engine assembly following the existing procedures in the applicable Service Manual.
 - On A/T models, use the special support tool p.n. 18632AA010 to support the transmission while the engine is removed. **VERY IMPORTANT: NEVER** use a jack or a block of wood on the oil pan of the A/T assembly as valve body damage can occur easily. On M/T models, a block of wood can be used to support the transmission.
 - Also on A/T models, **ALWAYS** install the torque converter stopper tool to keep the converter secured in the transmission when separating the engine.

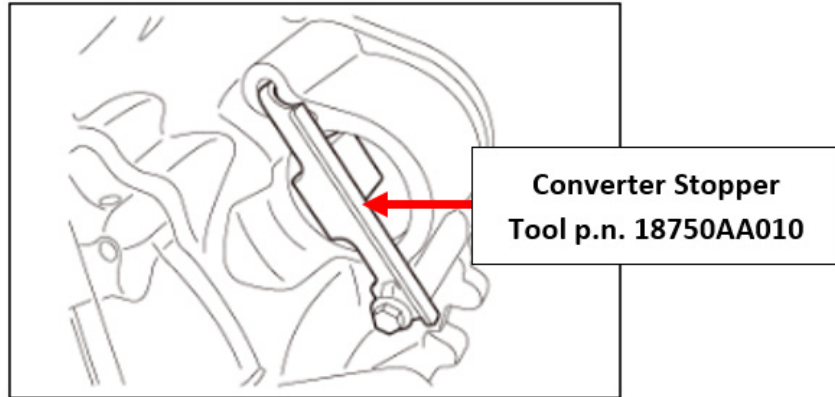

- 2) Secure the engine assembly to the engine stand using the four (4) bolt locations as shown below. Before tightening any of the bolts, position the engine on the stand so the crankshaft centerline is as close as possible to being aligned with the center pivot point of the engine stand. This will make the engine easier to rotate when switching from side to side.

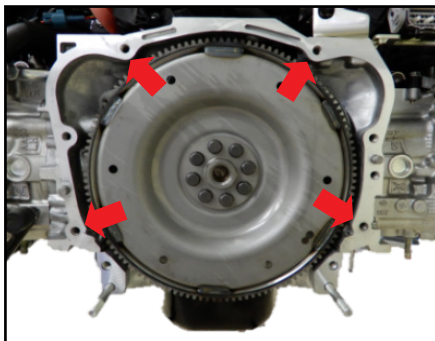

- 3) Remove both LH and RH intake manifold protectors.
- 4) Remove all the ignition coils and spark plugs. Leave the coils connected to the engine wiring harness.
- 5) Secure the ignition coils and harnesses to the intake manifold to keep them out of the work space.
- 6) Remove both LH and RH valve covers. Apply Silicone Gasket Remover spray and allow it to “soak” while performing other steps of the procedure. This will make removing the original sealer considerably easier.
- 7) Measure and record the cam clearances following the procedure in the applicable Service Manual.

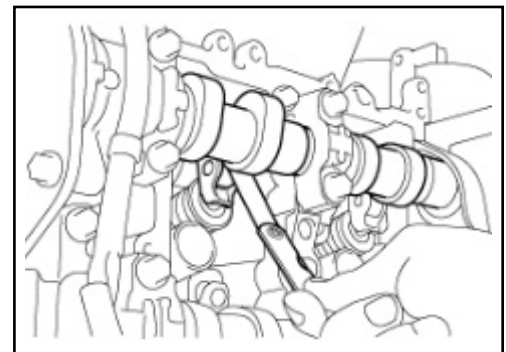

Continued...

IMPORTANT NOTES: The purpose for performing these cam clearance measurements is to compare the “before” and “after” values and confirm there was no change.

- If the clearances are out of specification, obtain the required shims for installation prior to reassembly.
- If the clearances are all within specification at this point but after reassembly, some are found to be out of specification, it is likely some of the shims were miss-positioned during reassembly. **CAREFULLY** Re-adjust as necessary to insure all clearances are within the following specifications:

Standard values (cold engine):

- **INTAKE:** 0.10 to 0.16 mm {0.0039 to 0.0063 in.}
- **EXHAUST:** 0.21 to 0.27 mm {0.0083 to 0.0106 in.}

8) **CAREFULLY** remove the timing chain cover, timing chain and all related components following the existing procedures in the applicable Service Manual.

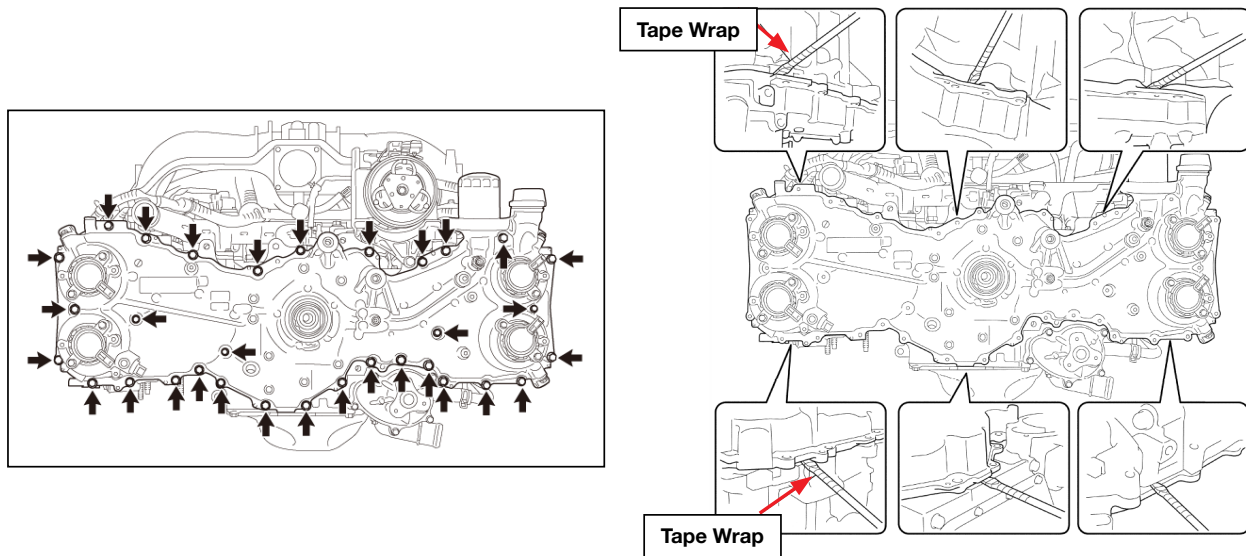

9) Apply a reference mark to the face of the removed crankshaft pulley using touch-up paint or a grease pencil adjacent to the locating pin hole as shown below.

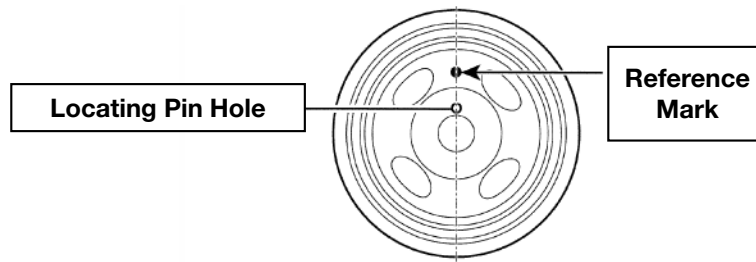

Continued...

TIPS: Remove and properly discard the engine oil filter. Stand the removed timing cover up as shown to allow any remaining oil to drain from the internal passages. This keeps residual oil from potentially contaminating fresh sealer applied to the cover at reassembly (which could cause a leak or a possible comeback). Always replace the oil filter at reassembly.



Use of aerosol Subaru Silicone Gasket Remover (p.n. SOA868V9175) along with white plastic razor blades and / or a sharpened plastic trim removal stick to use as a non-marring scraper will make this critical part of the procedure easier. Applying the Gasket Remover spray and allowing it to “soak” while performing other steps of the procedure will make the sealer removal job considerably easier. There are other color blades available but different colors have different stiffness characteristics. The WHITE color blades worked best during development of these procedures. Steel razor blades are NOT recommended as they can easily damage machined aluminum sealing surfaces.



10) Rotate the engine so the RH (cylinders #1 and #3) side face upward (crankcase seam horizontal).

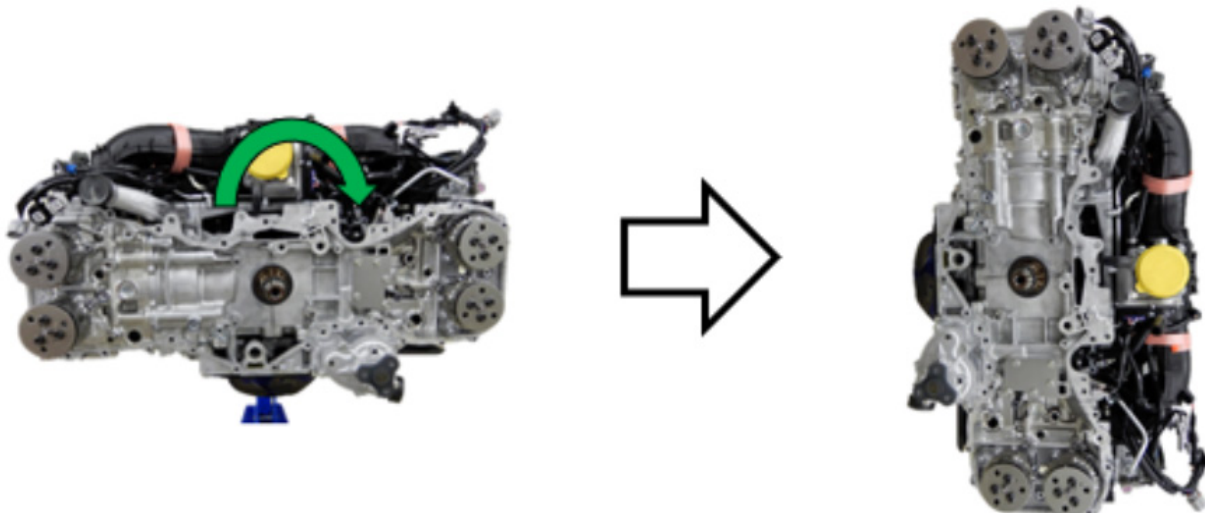

Continued...

11) **CAREFULLY** remove the camshaft caps, both camshafts, spark plug tube seals (discard, 1-time use) and either the cylinder head plate (on M/T models) or the vacuum pump (on A/T models) as shown below. Spray any remaining sealer with gasket remover and allow to soak.

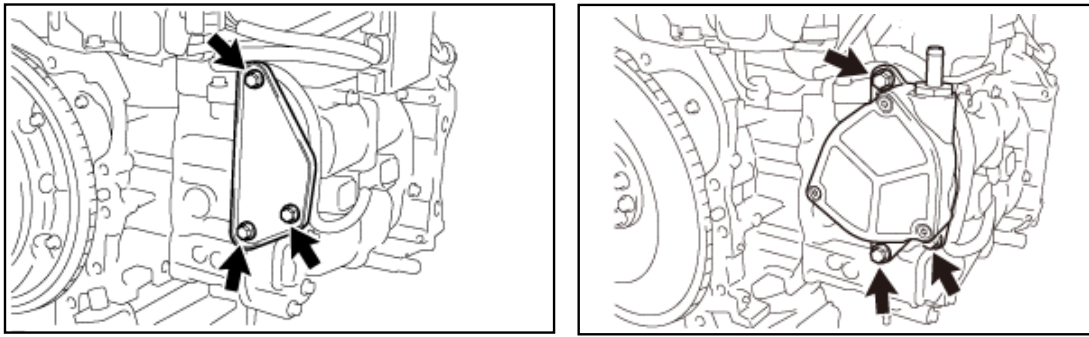

VERY IMPORTANT:

A. Always record the positions of the cam caps, every rocker arm and valve shim as each is removed to insure they get reinstalled back into their original locations and proper orientation. The use of a closeable partitioned tray as shown below or an equivalent organizer is **STRONGLY** recommended to keep valve train parts organized.

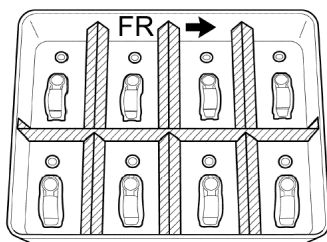

B. DO NOT remove the sprockets from the camshafts.

C. DO NOT remove the cam carriers or the rocker arm pivots from the cylinder heads.

D. **IMPORTANT:** Always keep close watch for any loose pieces of sealer, large or small as components are disassembled and remove them right away. This will help prevent them from getting into oil passages, restricting oil flow and potentially causing damage as shown here.



Sealant Plugging Lubrication Channel



Oil Strainer Plugged



Oil Screen Plugged

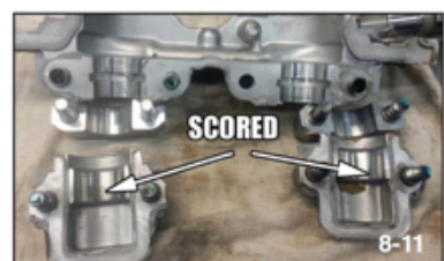

Cam Cover Scored

Continued...

12) Air Piping and Regulator Assembly

Assemble the air pressure regulator assembly as shown with the shop air supply inlet on the left and the outlet fitting to connect the plastic tubing to the right. The air pressure regulator will be ineffective otherwise. Once the tool is assembled, connect shop air, open the valve and let air flow through to make sure it is clean. Pull up on the adjustment knob, adjust to **0.5 MPa** then push the knob back down to lock the setting.

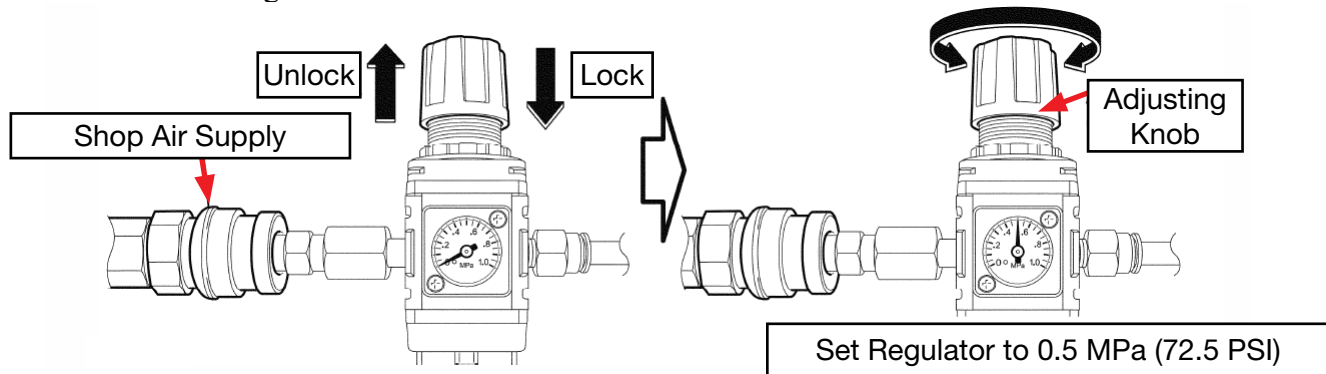
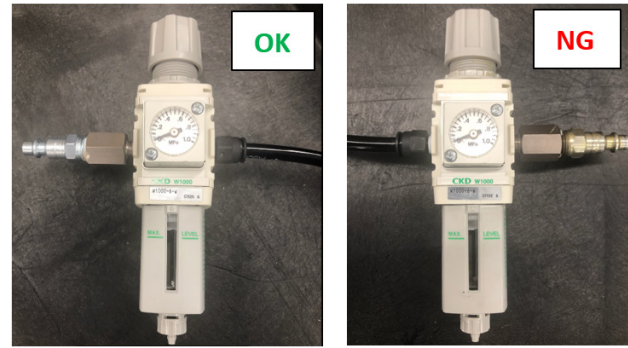

IMPORTANT NOTE: NEVER connect compressed air to any of the spark plug adapters until instructed to do so in this procedure.

13) Valve Spring Replacement

VERY IMPORTANT:

Never replace valve springs on a cylinder not positioned at top dead center (TDC). If the retainer was removed and the valve were to drop, the piston would keep it from falling into the cylinder. If the piston were at bottom dead center (BDC), the valve could drop through the guide and into the cylinder necessitating cylinder head removal.

The valve springs on **Cylinder #1** will be replaced first in this procedure. Temporarily install the crankshaft spacer, pulley and hand-tighten the retaining bolt (snug). Rotate the crankshaft clockwise until the reference mark applied to the face of the crankshaft pulley is at 12:00 (perpendicular to the crankcase seam). This will place the piston in cylinder #1 at TDC and cylinder #3 at BDC.

Install the 2 spark plug adapters into #1 and #3 spark plug holes. Make them as tight as possible **without** using any extra tightening tools. **Hand-tightening only** will seal the adapters tight enough. Connect both air hoses to the spark plug adapters and **SLOWLY** (5 seconds from closed to open), open the shut-off valve. A slight amount of air leakage is normal. If the engine rotates, return the crankshaft to the proper position and try again.

REMINDER: Hand-tightening only.

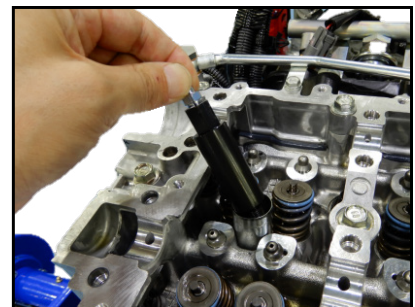

Continued...

TIP: Although the remover and installer tools are “magnetized” to keep the related components in position during use, it is **STRONGLY** recommended to have a stick / pocket magnet or equivalent available to retrieve any small parts which may come loose when performing these procedures. Use clean shop cloths to plug oil passages and prevent small parts (or loose sealer pieces) from entering the crankcase

Using the removal tool, press down firmly on the top of the remover while keeping the tool aligned with the valve stem then remove one of the valve springs on #1 cylinder. **NOTE: NEVER HIT ANY OF THESE TOOLS WITH A HAMMER!** It is recommended to do the removal and installation one spring at a time to keep the retainer, keepers together as a set in the organizer.

Valve Spring Remover

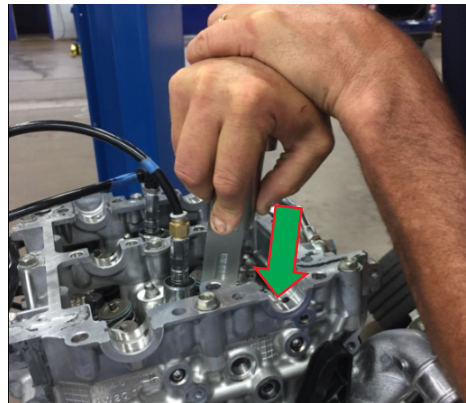

The cutaway illustration below provides extra detail on how the Remover tool operates. When the tool is pushed down, the keepers disengage from both the retainer and the valve stem. Once they are loose, all three pieces (2 keepers and the retainer) are attracted to the tool's magnets for removal.

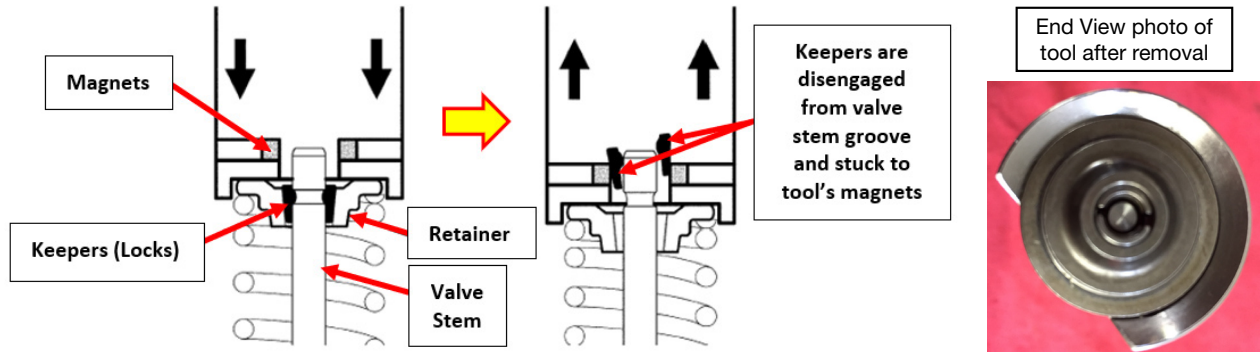

NOTE: Before installing the new valve springs, although engine oil usually keeps them in position, always confirm the steel spring seats remain in place against the aluminum cylinder head.

Install the new valve spring with the blue painted end up (toward the retainer).

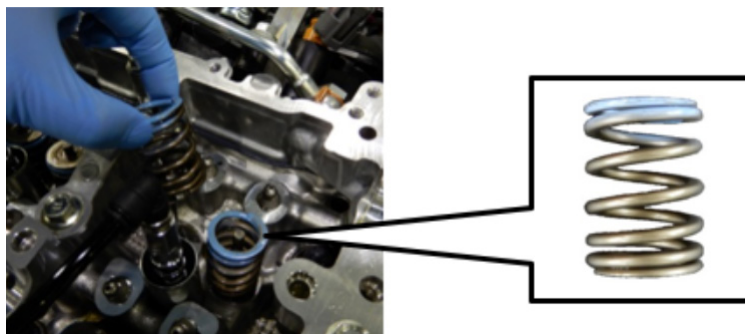

Continued...

Assemble the keepers and retainer then install onto the Valve Spring Installer as shown below. The tool is also equipped with magnets to keep the components in place during reassembly. OK and NG photos are provided below for reference.

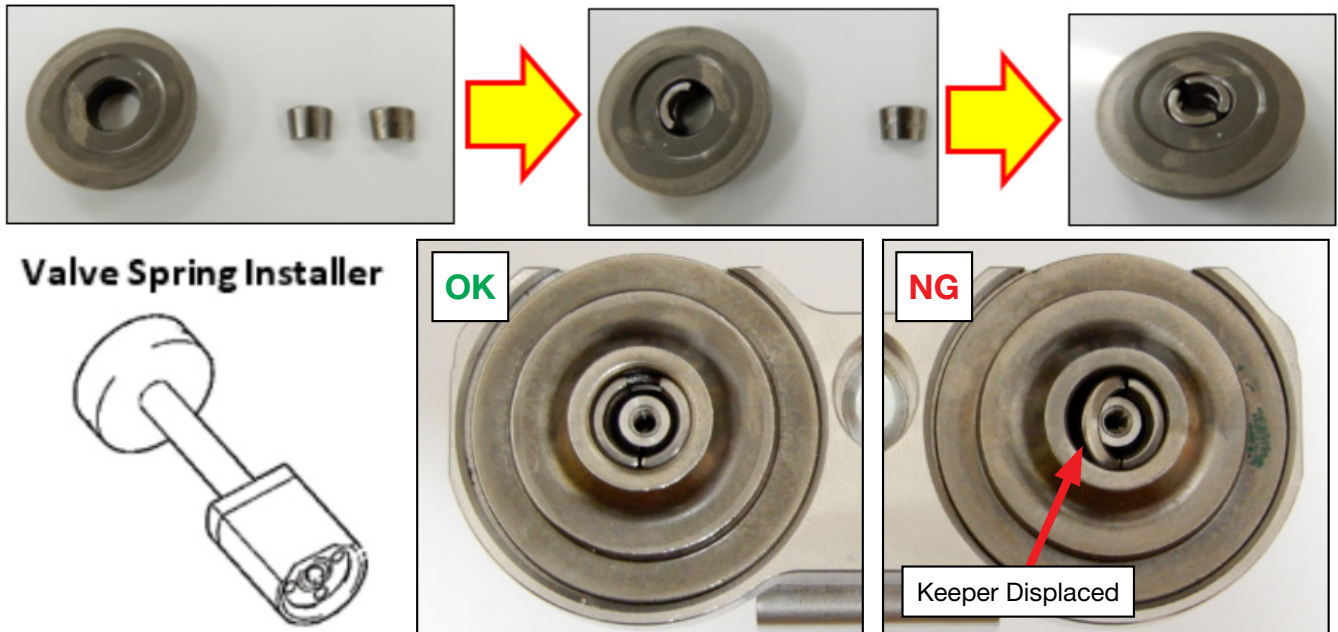

Once the keepers and retainers are properly assembled on the Installer, press down firmly on the top of the tool as shown while keeping the tool aligned with the valve stem.. Remove the tool to confirm the retainer and keepers are in their proper positions on the spring and the valve stem. Develop a “feel” for how far down the installer needs to be pressed to achieve the proper result. Post-installation “OK” and “NG” photos are provided below for reference. If the result is NG, remove the installer, disassemble (use the Remover if necessary) then reassemble on the Installer. Confirm the retainers and keepers are in their proper positions on the tool and try again.

This cutaway illustration provides additional detail on how the Installer tool operates.

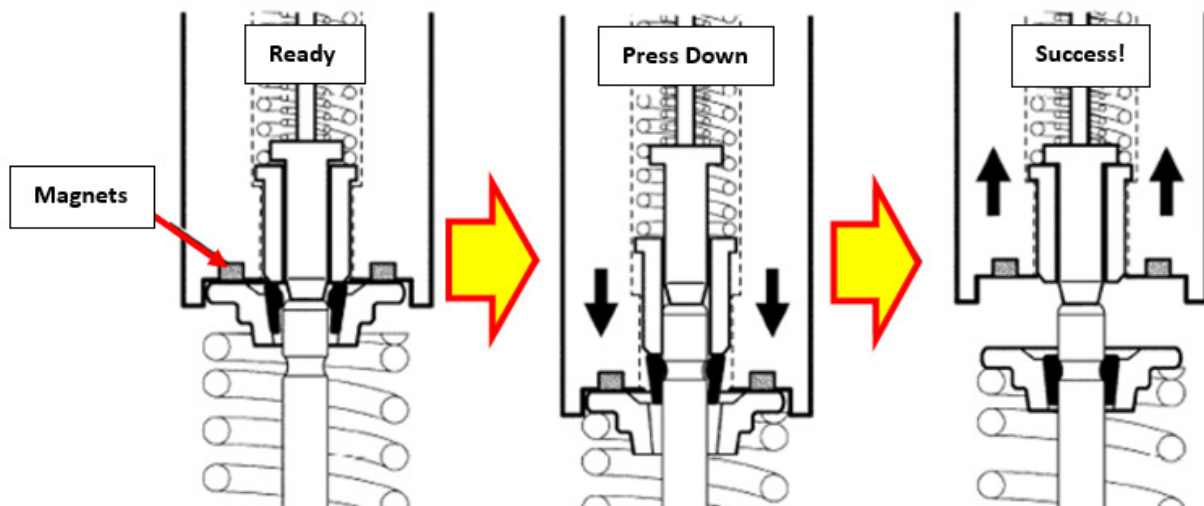

Continued...

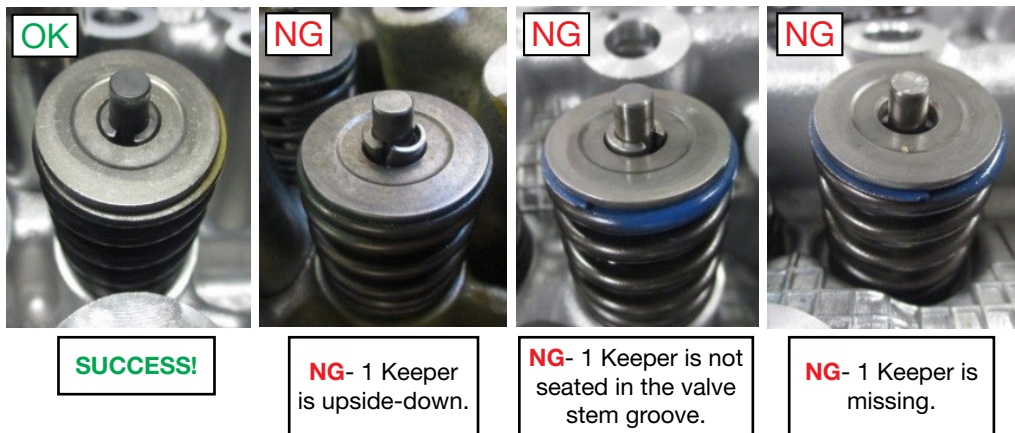

EXTREMELY CRITICAL: A post-installation inspection to confirm success as shown above **MUST** be performed as each spring is reassembled. Left undetected, a mis-placed or out of position keeper **WILL** cause **MAJOR** engine damage when the engine is restarted.

Once successful reassembly is confirmed, proceed to replace the other three (3) valve springs on #1 cylinder following the same steps as outlined above.

After completing the remaining spring replacements on #1 cylinder, close the air shut-off valve and remove the air hoses from the spark plug adapters.

Rotate the crankshaft 180 degrees clockwise to put the mark at 6:00. This will bring #3 piston to TDC.

Reconnect the air hoses to the spark plug adapters and **SLOWLY** (5 seconds from closed to open), open the shut-off valve. A slight amount of air leakage is normal. If the engine rotates, return the crankshaft to the proper position and try again.

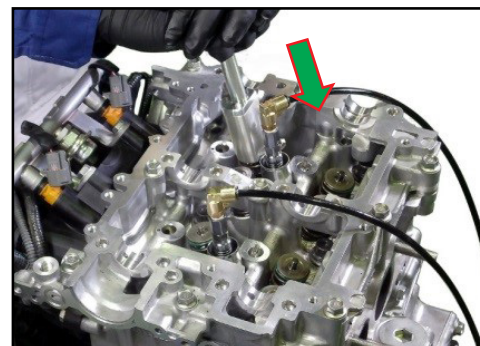

Follow the procedure outlined above starting at **Step 13** and replace the four (4) valve springs on #3 cylinder.

REMINDER: A post-installation inspection to confirm success as shown above **MUST** be performed as each spring is reassembled. Left undetected, a mis-placed or out of position keeper **WILL** cause **MAJOR** engine damage when the engine is restarted.

Before Reassembly:

When valve spring replacement and inspections are complete on cylinder #1 and #3, **THOROUGHLY** clean any remaining sealer from the sealing surfaces of the cylinder head, cam caps, valve covers and the front timing cover.

VERY IMPORTANT: It is critical to make sure all the original sealer is removed and the affected sealing surfaces completely clean and dry before applying any new sealer. After cleaning, a thorough inspection of the inside surfaces of the cylinder head area around the valve springs, inside the front timing cover and inside all the cam caps for any small pieces / bits of removed sealant or any other contamination is essential to providing a quality repair. Any contamination left behind can cause the Check Engine light to illuminate and / or other issues to develop resulting in a comeback.

Continued...

14) Cylinder #1 and #3 Valve Train Reassembly:

Apply a small amount of engine oil to all the valve shims and install them onto their respective valve stems.

Apply a small amount of engine oil to all the rocker arms and install them onto their respective pivots.

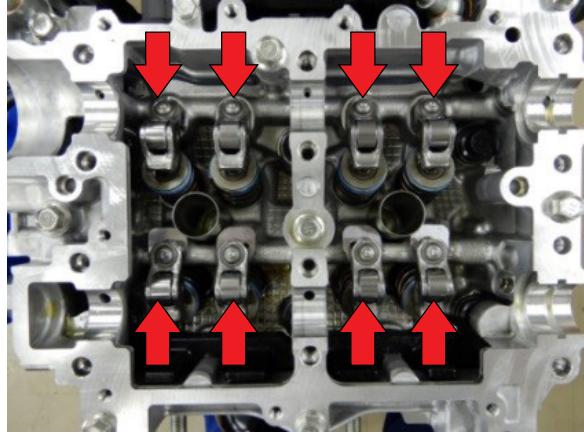

Apply engine oil to the camshaft journal areas and re-install the camshafts in the no-load (free) position.

CAREFULLY apply ThreeBond 1217H or equivalent (see Recommended Materials TSB **01-167-08R**) sealant to the front and rear cam caps as described in the applicable Service Manual.

Apply a small amount of engine oil to the camshaft journal surfaces of the cam caps then install them while following the tightening and torquing sequences outlined in the applicable Service Manual.

IMPORTANT: Before proceeding further and while the camshafts are in their no-load (free) positions, recheck all valve clearances and compare to the original measurements. This will confirm no changes have occurred during the repair and that all the shims and rocker arms have been reinstalled to their original locations.

After removing any remaining original sealant, reinstall either the cylinder head plate (M/T) or the vacuum pump (A/T). **NOTE:** Always use the new o-rings supplied in the parts kit where applicable and torque the retaining bolts to specification.

Confirm any remaining original sealant has been removed from the valve cover and all sealing surfaces are clean and dry. Install the new valve cover gasket to the valve cover and two of the new spark plug tube seals included in the parts kit.

CAREFULLY apply ThreeBond 1217H or equivalent sealant to the valve cover in the specific areas as described in the applicable Service Manual.

Install the valve cover and retaining bolts. Follow the tightening and torquing sequences outlined in the applicable Service Manual.

Reinstall the injector driver module retaining bracket.



Continued...

15) Cylinder #2 and #4 Procedure:

Rotate the engine so the LH (cylinders #2 and #4) side face upward (crankcase seam horizontal).

Remove the fuel delivery pipe for the LH injectors, fuel delivery pipe #2 from the high-pressure fuel pump and the high-pressure fuel pump assembly. Leave the black fuel line attached to pump. Remove the pump drive case (mounts the fuel pump to the cylinder head) from the cylinder head.

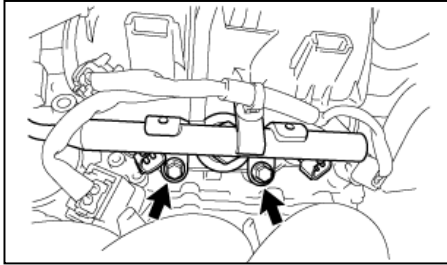

Remove Fuel Delivery Pipe LH. Replacement o-rings are included in the Parts Kit.

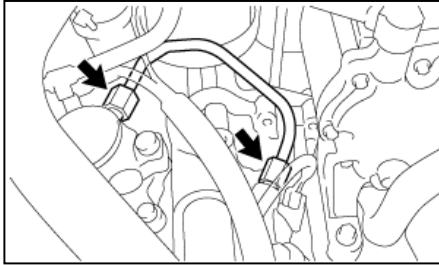

Remove and discard Fuel Delivery Pipe #2 (1-time use). A replacement is included in the Parts Kit.

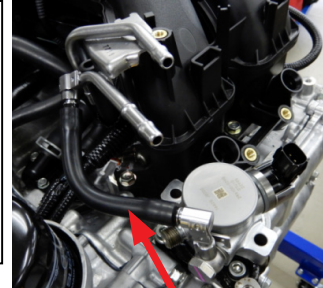

Leave attached to pump.

Rotate the crankshaft 180 degrees clockwise to put the mark (back) at 6:00. This will bring #2 piston to TDC.

Following the same procedures as outlined above, replace the valve springs on #2 cylinder.

When complete. Rotate the crankshaft another 180 degrees clockwise to put the mark at 12:00. This will bring #4 piston to TDC.

Following the same procedures as outlined above:

- Replace the valve springs on #4 cylinder.
- Reassemble the valve train.
- Recheck and compare the valve clearances against the original measurements.
- Reinstall the pump drive case, cam follower and high-pressure fuel pump. Always use the new o-rings and the new steel fuel pipe #2 included in the parts kit. Follow applicable Service Manual instructions for torquing procedures.

TIP: A 3/8" drive 17mm crow-foot flare nut wrench is needed to properly torque the compression nuts used on both ends of the new fuel pipe #2. **REMINDER:** NEVER attempt to re-use the original fuel pipe #2.

- Reinstall the fuel delivery pipe LH using all new o-rings supplied in the parts kit.

16) Rotate the engine back to horizontal position and reinstall the timing chains and related components following the procedures in the applicable Service Manual.

17) ALWAYS install the new front crankshaft oil seal **DRY** (no oil on the inside or outside of the seal or timing cover and always use the proper installer) along with the new o-ring for the crankshaft extension included in the parts kit. See TSB **02-161-15R** for more information on this important step.

Continued...

18) CAREFULLY apply sealant to the front cover closely following the applicable Service Manual procedure. **REMINDER:** There are three (3) different length bolts used to secure the front cover. Make sure the correct length bolts are used in each hole.

TIPS:

- BEFORE installing the front engine cover, always make sure all the 6mm bolt holes, ESPECIALLY “blind” holes are fully cleaned of any remaining sealant. When tightening the bolts, any remaining sealant can “hydrolock” in the bolt hole resulting in damage to the threads and / or the casting. The photo below shows a damaged front cam cap casting caused by tightening a front cover bolt while sealant remained in the blind hole coming from the front side.



- Always make sure any places where collections of residual oil have developed around the front of the cylinder heads and crankcase are wiped clean. If oil drips onto any of the front cover sealing surfaces, the fresh sealant could be compromised and a potential leak develop as a result.
- When re-installing the front cover assembly, be very careful to not allow it to contact the timing sprockets. If contact does occur, it is almost a guarantee the fresh sealant beads applied to the cover will be disturbed. To minimize the possibility of this happening, ALWAYS use the alignment pins shown below to “guide” the cover into its proper position without disturbing the fresh sealer. The Subaru Special Tool Kit number is J-51972. Each kit includes 2 alignment pins.

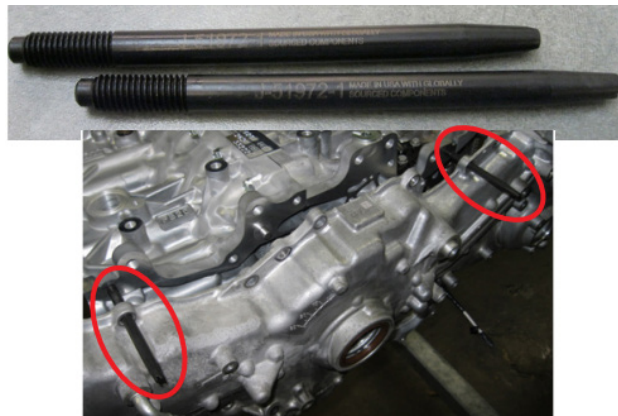

- After mounting the cover to the engine, always make sure ALL the retaining bolts are finger-tight BEFORE beginning the final tightening / torquing sequence.

19) Reinstall the front crank pulley and torque the bolt following the procedure in the applicable Service Manual. Finish reassembly of the remaining components in reverse order of removal.

Continued...

Section 3: FB Engine Procedure:

TIPS:

- Road test the vehicle before disassembly to confirm the engine operates as designed with no abnormalities (e.g. smoke from exhaust, engine noise, fluid leak(s), A/C system operation, etc.).
- Check for any DTC(s).
- Check for any vehicle modifications and if found, document them using the existing process outlined in the Claims Policies and Procedures section **8.4.45** “Procedures for Assessment, Documentation, and Notification of Non-Warrantable Repairs” using the “Vehicle Modification and Accident Damage Report” found on Subarunet under Service-Technical / Forms / Downloads.
- Note and review any items needing attention with the customer before proceeding. Having the customer initial these item by item on the repair order is highly recommended.
- Contact the SOA Techline immediately to review any concerns believed to be impeding or preventing proper completion of this recall. There should be very few if any cases where this would be necessary. A severe example of an impediment would be if the wrong specification engine is found to be installed. Nearly all aftermarket modifications can be worked around or removed to allow valve spring replacement to proceed.
- Contact the SOA Claims Team should removal and / or reinstallation of these customer modifications require significant additional time.
- Open both door windows before disconnecting the battery.
- Remove the fuel cap to release any vapor pressure inside the fuel tank and to prevent fuel spray when disconnecting fuel lines.
- Remove the fuel pump fuse, then start and run the vehicle until it stalls to relieve fuel pressure.
- Record the customer’s radio station presets (and Navigation System Favorites if applicable) then disconnect the battery negative cable from the battery terminal.
- Separate the exhaust manifold assembly from the front exhaust pipe and remove the manifold from the vehicle. The manifold to cylinder head gaskets are included in the parts kit.
- Evacuate the A/C system and leave the A/C compressor assembly bolted to the engine. Remove both lines from the compressor. Always protect any exposed connections from contamination while the system is open.
- Drain the engine oil and coolant.
- **VERY IMPORTANT: NEVER** use a jack on the oil pan of the CVT assembly. A block of wood between the front of the converter housing and front chassis crossmember can be used to support the transmission while the engine assembly is removed.
- Also on CVT models, ALWAYS install the torque converter stopper tool to keep the converter secured in the transmission when separating the engine.

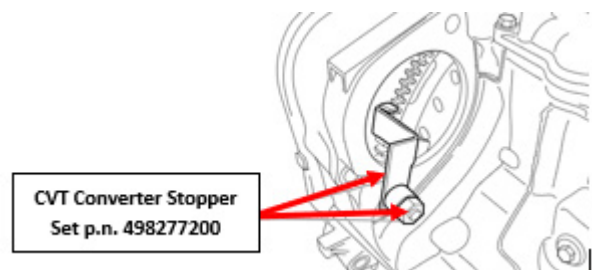

Continued...

- 1) Remove the engine assembly following the existing procedures in the applicable Service Manual.
- 2) Secure the engine assembly to the engine stand using the four (4) bolt locations as shown below. Before tightening any of the bolts, position the engine on the stand so the crankshaft centerline is as close as possible to being aligned with the center pivot point of the engine stand. This will make the engine easier to rotate when switching from side to side.

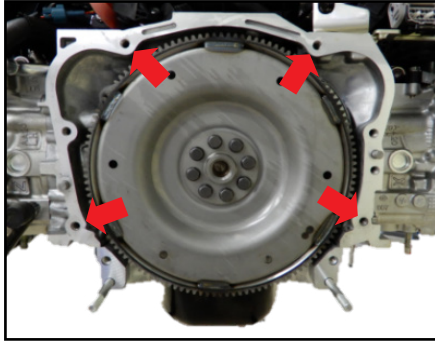

- 3) Remove both LH and RH intake manifold protectors.
- 4) Remove all the ignition coils and spark plugs. Leave the coils connected to the engine wiring harness.
- 5) Remove both LH and RH valve covers. Apply Silicone Gasket Remover spray and allow it to “soak” while performing other steps of the procedure. This will make removing the original sealer considerably easier.
- 6) Measure and record the cam clearances following the procedure in the applicable Service Manual.

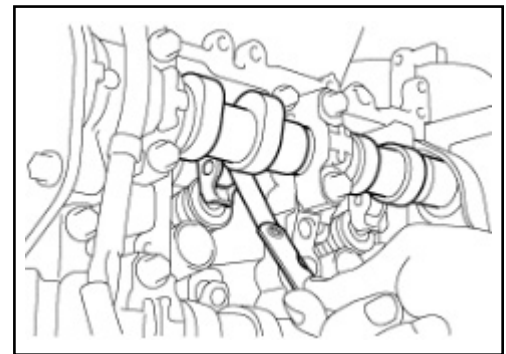

IMPORTANT NOTES: The purpose for performing these cam clearance measurements is to compare the “before” and “after” values and confirm there was no change.

- If the clearances are out of specification, obtain the required shims for installation at reassembly.
- If the clearances are all within specification at this point but after reassembly, some are found to be out of specification, there is a possibility the shims in question may have been mixed up while removed. Re adjust as necessary to insure all clearances are within the following specifications:

Standard values (cold engine):

- **INTAKE:** 0.11 to .015 mm {0.0051 + .0051 to - .0012 in.}
- **EXHAUST:** 0.20 to .024mm {0.0087 +/- .0008 in.}

- 7) Rotate the engine so the RH (cylinders #1 and #3) side face upward (crankcase seam horizontal).

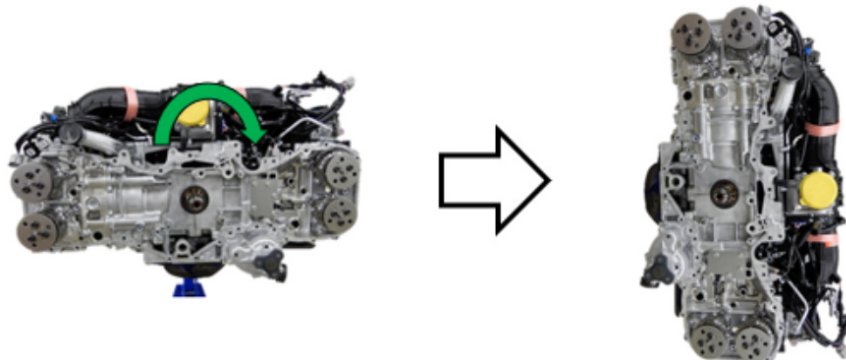

Continued...

REMINDER: When performing this valve spring replacement on a FB engine, removal of the timing cover (and related components) is **NOT** required.

The valve spring replacement tools consist of a set of four different spring compressor tools, two retainer / keeper re-installation tools and a “bridge” framework to properly position each tool for use.

- **Bridge Base and Bracket Set**, p.n. 99850AA020 (for use on **FB engines ONLY**)



IMPORTANT REMINDER: NEVER attempt to use any of these valve spring replacement tools on a 2015MY or later 2.5L FB engine. Although the Bridge Base and Bracket set bolts to the cylinder heads normally, **the spacing between the valve stems is different**. Attempting to use any of the compressor tools or spring installers on a 2015MY or later 2.5L FB engine **WILL** damage them.

- **Valve Spring Compressor and Installation Tool Set**, p.n. 99850AA030 (for use on **pre-2015MY FB engines ONLY**).

REMINDER: The tools for servicing the **INTAKE** valves have **WHITE** paint markings whereas the tools for servicing the **EXHAUST** valves have **GREEN** paint markings.

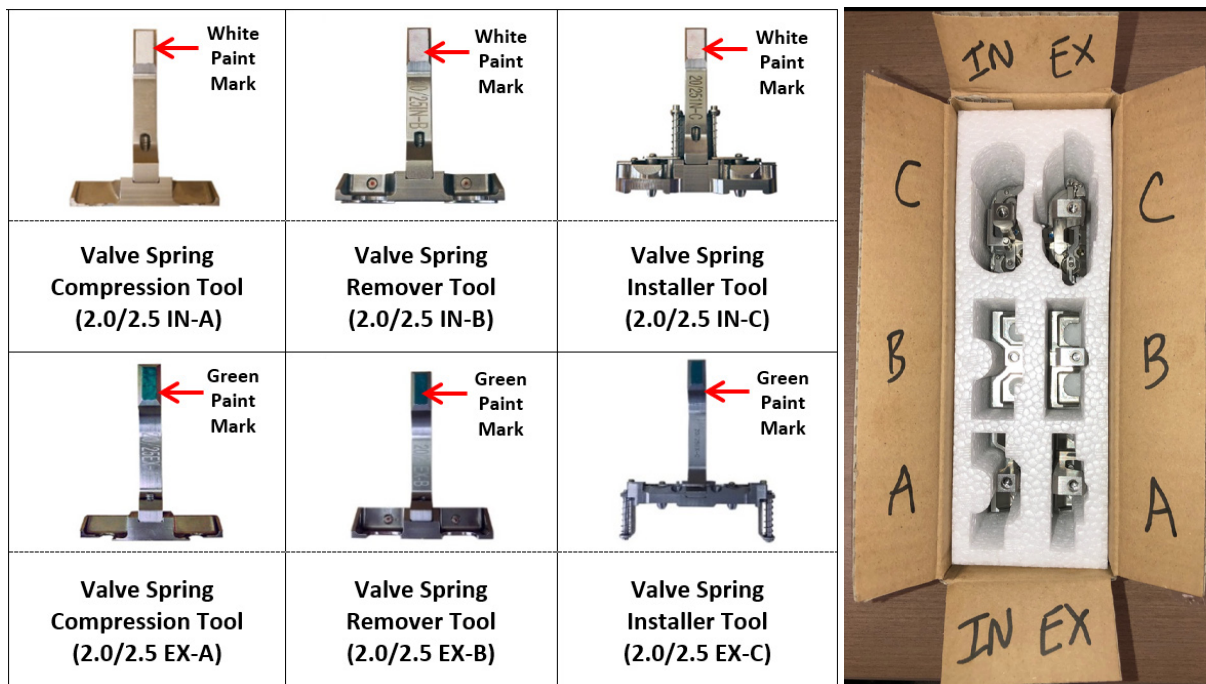

Continued...

VERY IMPORTANT NOTES:

- When using the above compressor and spring installation tools, use **ONLY** the tool specified for the specific task being performed. Although some of these tools look very similar to each other, there are significant design differences in each which make them specific for each function of this procedure. This is why they have the paint markings and alpha-numeric identification information etched onto them.
- It is strongly recommended to keep these special tools in the compartments of the storage box they were shipped in as each tool is used as shown in the photo above. When an operation is done, put the tool used for that operation back into its individual spot in the storage box. This will minimize chances of mis-placing or dropping / damaging them along with helping to stay organized.
- All of the 6 mm bolts securing the bridge bases to the head and the brackets to the bridge bases do not need to be any more than **hand tight and lightly “snugged” with a 10mm wrench. DO NOT over-tighten** any of these bolts.
- The six (6) shorter 6 mm bolts secure the bridge bases to the cylinder head and the four (4) longer 6 mm bolts secure the bridge brackets to the bridge bases.
- There is a pair of bridge bases for the RH and LH cylinder heads. They are NOT interchangeable.
- The bridge brackets have alignment pins to insure they are assembled properly.
- Always make sure the “push bolts” which pass through the bridge brackets and supply the force to operate the compression and installer tools are always kept lubricated with engine oil.
- Always turn the crankshaft **clockwise** when instructed to reposition it.

- 8) Install the 2 spark plug adapters into #1 and #3 spark plug holes. Make them as tight as possible **without** using any extra tightening tools. **Hand-tightening only** will seal the adapters tight enough.



IMPORTANT REMINDER: NEVER connect compressed air to any of the spark plug adapters until instructed to do so in the procedure.

- 9) Assemble the RH bridge bases onto the RH cylinder head and the bridge brackets to the bridge bases.

TIP: Leave all the 6 mm bolts finger-tight until the bridge brackets are properly installed onto the bridge bases. Once all ten (10) bolts are finger-tight, **LIGHTLY** snug them with a 10 mm wrench.

Bridge Bases and Brackets assembled on RH cylinder head.

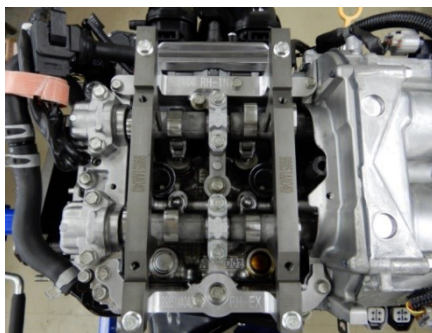

Special 6 mm Push Bolt and their locations on the bridge brackets.



Continued...

- The valve springs will be replaced in the following order: cylinders #3 and #1 then #2 and #4.

10) Valve Spring Replacement

These steps are in the order to be followed throughout the procedure for each cylinder. Cylinders #1 and #3 will be the primarily referenced cylinders for this section.

- A. Rotate the crankshaft clockwise until #1 piston is at TDC. Mark the crankshaft pulley as shown for reference. This will make locating TDC for each cylinder easier. TDC of #1 and #2 cylinders are 180 degrees opposite of #3 and #4.

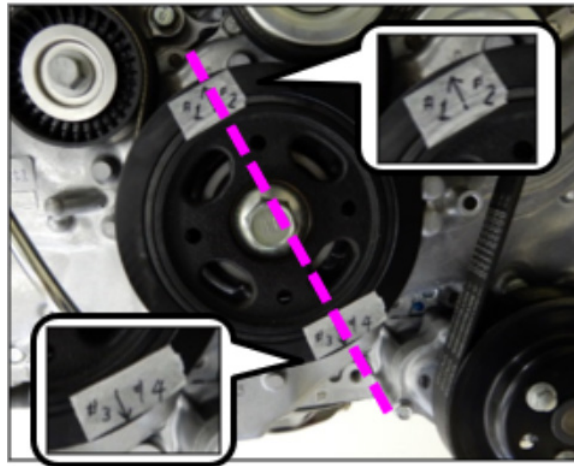

- B. Confirm all four rockers on #1 cylinder are “relaxed” or “free”.
- C. Insert compression tool 2.0/2.5 IN-A (WHITE paint mark) into the corresponding bridge bracket guide slot and onto the retainers and keepers for #1 cylinder’s INTAKE valves.

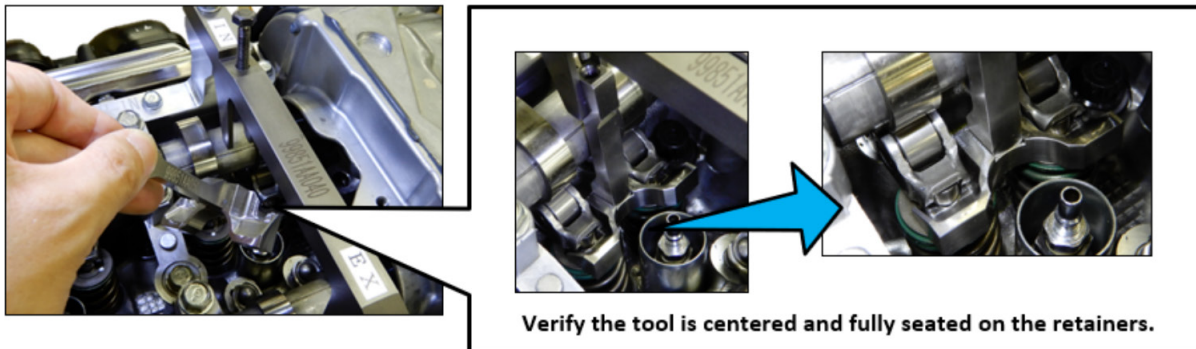

- D. After confirming the pilot end of the push bolt is inserted into the receiver hole in the top of the compression tool and the bottom of the tool is properly seated squarely on the spring retainers, **CAREFULLY** tighten the push bolt to compress the pair of complete intake “valve assemblies” (the compressor tool pushes on both the retainers AND their keepers) to allow removal of one (1) pair of intake rockers and adjusting shims. Tighten the push bolt until it bottoms out on the bridge bracket as shown below.

Continued...

IMPORTANT: If the push bolt ever tightens before bottoming out on the bridge bracket **STOP IMMEDIATELY** and investigate the cause before damaging the tool and / or any valve train components.

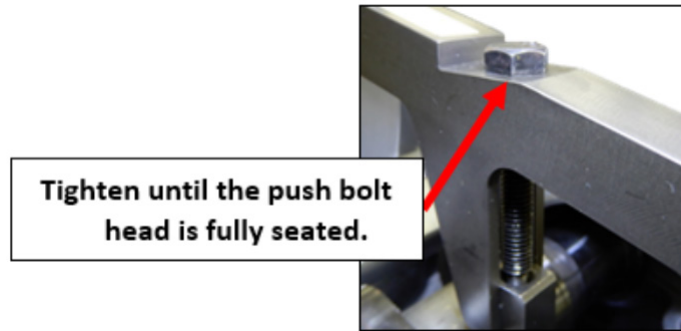

REMINDER: Always record the positions of every rocker arm and valve shim as each is removed to insure they get reinstalled back into their original locations. The use of a closeable partitioned tray as shown below or an equivalent organizer is **STRONGLY** recommended to keep valve train parts organized.

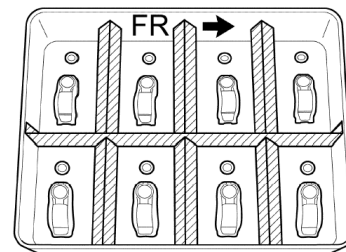

- E. Loosen the push bolt and remove the compression tool.
- F. Insert compression tool **2.0/2.5 EX-A** (**GREEN** paint mark) into the corresponding bridge bracket guide slot and onto the retainers and keepers for **#1** cylinder's **EXHAUST** valves.
- G. After confirming the pilot end of the push bolt is inserted into the receiver hole in the top of the compression tool and the bottom of the tool is properly seated squarely on the spring retainers, **CAREFULLY** tighten the push bolt to compress the pair of complete exhaust "valve assemblies" and remove the intake rockers and adjusting shims in the same manner.
- H. Loosen the push bolt and remove the compression tool.
- I. Rotate the crankshaft **clockwise 180 degrees** to bring **#3** piston to TDC.
- J. Repeat steps **B** through **H** to remove the rockers and shims on **#3** cylinder.

REMINDER: Never replace valve springs on a cylinder that is not at top dead center (TDC). If the retainer were removed and the valve to drop, the piston will keep it from falling into the cylinder. If the piston were at bottom dead center (BDC), the valve could drop through the guide and into the cylinder necessitating cylinder head removal.

- At this point, the **INTAKE** valve springs on **#3** cylinder will be replaced.
- K. With shop air supply connected and the regulator set to 0.5MPa, connect one of the air hoses to the spark plug adapter in **#1** cylinder. **SLOWLY** (5 seconds from closed to open), open the shut-off valve. A slight amount of air leakage is normal.

Continued...

L. Connect the other air hose to #3 cylinder's spark plug adapter.

M. Insert compression tool 2.0/2.5 IN-B (WHITE paint mark) into the corresponding bridge bracket guide slot and onto the retainers for #3 cylinder's INTAKE valves. As shown below, the opening on these spring compression tools is wider than the compression tools used previously. This allows room for the keepers to come loose from the valve stem when the spring is compressed.

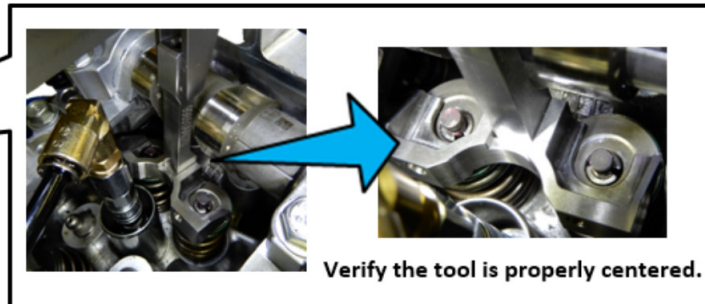
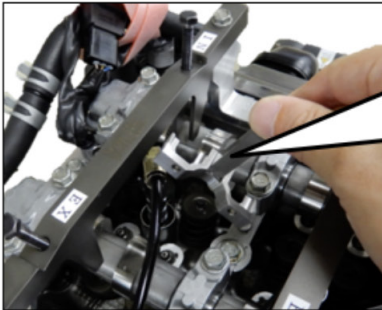

N. Tighten the push bolt until it bottoms out on the bridge bracket. Use a magnet to remove the keepers and put them in the organizer with the corresponding rockers and shims.

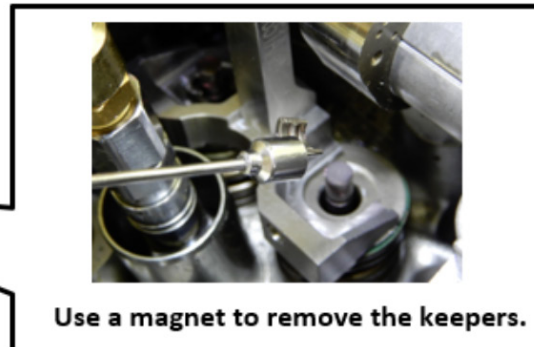

O. Loosen the push bolt and remove the compression tool.

P. Remove the retainers and original valve springs using a magnet.



NOTE: Before installing the new valve springs, although engine oil usually keeps them in position, always confirm the steel spring seats remain in place against the aluminum cylinder head.

Continued...

- Q. Set #3 cylinder's pair of INTAKE valve springs in place on the cylinder head with the blue painted end up (toward the retainer).
- R. Assemble the pair of INTAKE keepers and corresponding retainers onto the installer tool 2.0/2.5 IN-C (WHITE paint mark). Both installer tools utilize magnets to keep the retainers and keepers in position. Use the photos below as a guide for proper component assembly onto the installer tool.

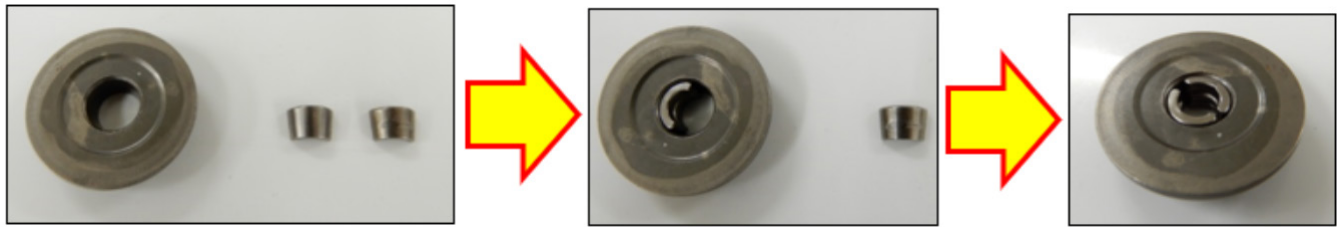

Both keepers are protruding the same amount from the bottom of the retainer.

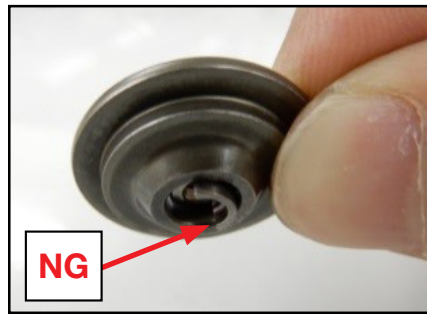

INTAKE Installer Tool: 20/25 IN-C

NOTE: When the retainers and keepers are properly assembled (or “loaded”) on the installer tool, the keepers will be drawn upward into the tool by the tool’s magnets as shown in the photo below, right. This is normal. **OK** and **NG** reference photos of the components loaded on the installer tool are provided below.

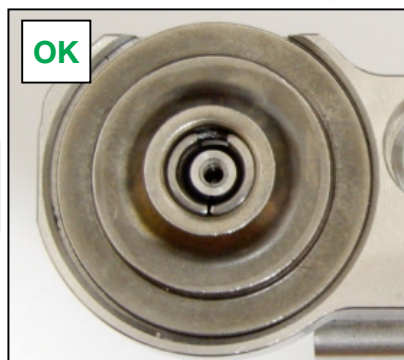
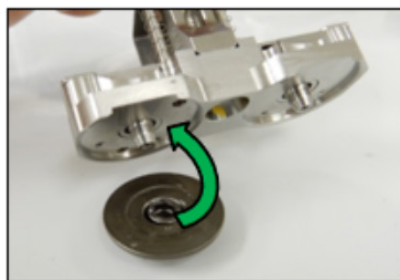

Keepers are centered.

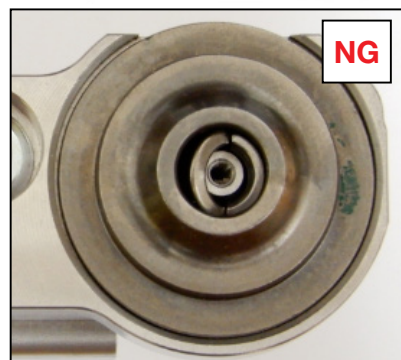

Keepers are either mis-aligned or, one is upside-down.

Continued...

- S. Set the loaded valve spring installer tool into the guide slot on the bridge bracket and down onto the #3 cylinder INTAKE valve springs. Finger-tighten the push bolt to remove all free-play. Make a final check to confirm the tool is properly positioned on the new pair of valve springs then SLOWLY start to tighten the push bolt to install the retainers and keepers.

CAUTION: If air pressure begins to leak from the cylinder (past the valve seat into the intake or exhaust ports) when starting to tighten the push bolt, it means the installer tool is not positioned properly (not centered) and the intake valves are starting to be pushed open. Loosen the push bolt and re-confirm the retainers and keepers are still in their proper positions and the loaded tool is also in the proper position on the valve springs. SLOWLY re-tighten the push bolt until it bottoms on the bridge bracket.

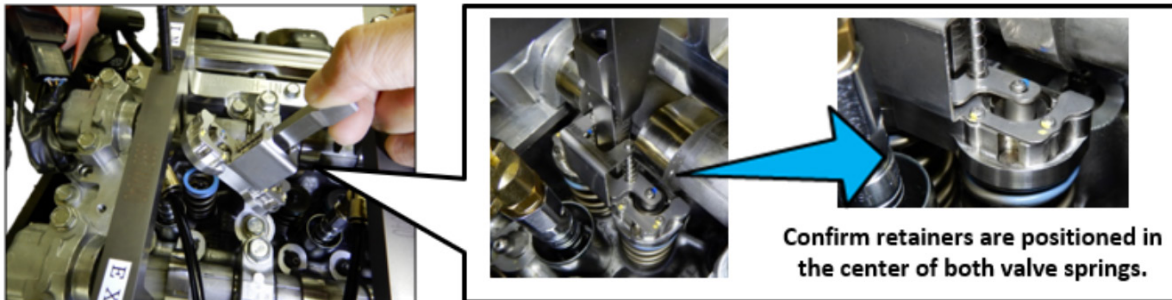

- T. Loosen the push bolt and remove the installer tool. CAREFULLY inspect both springs for successful, properly seated retainers and keepers. Use the reference photos below as a guide for confirmation.

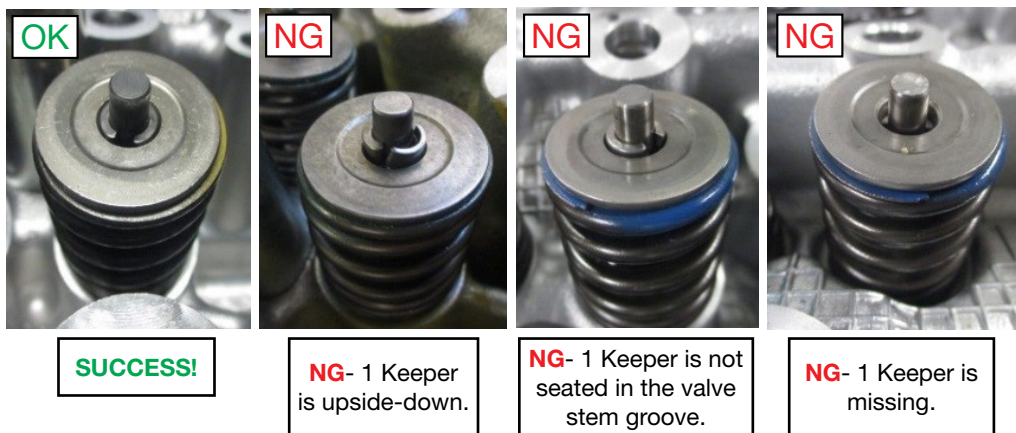

EXTREMELY CRITICAL: If any of the NG conditions shown above exist, use the applicable spring compressor tool to remove the pair of retainers and keepers then return to Step R above and start over. If installation is successful, proceed to install the EXHAUST springs.

- U. Insert compression tool 2.0/2.5 EX-B (GREEN paint mark) into the corresponding bridge bracket guide slot and onto the retainers for #3 cylinder's EXHAUST valves. Tighten the push bolt until it bottoms out on the bridge bracket. Use a magnet to remove the keepers and put them in the organizer with the corresponding rockers and shims. Loosen the push bolt and remove the compression tool. Remove the retainers and original valve springs using a magnet.
- V. Set #3 cylinder's pair of EXHAUST valve springs in place on the cylinder head with the blue painted end up (toward the retainers).

Continued...

W. Assemble the pair of EXHAUST keepers and corresponding retainers onto the installer tool **2.0/2.5 EX-C** (**GREEN** paint mark) as shown below and in **Step S** above. Both installer tools utilize magnets to keep the retainers and keepers in position. Although the exhaust spring installer looks somewhat different than the intake tool, they function the same way but they are **NOT** interchangeable.

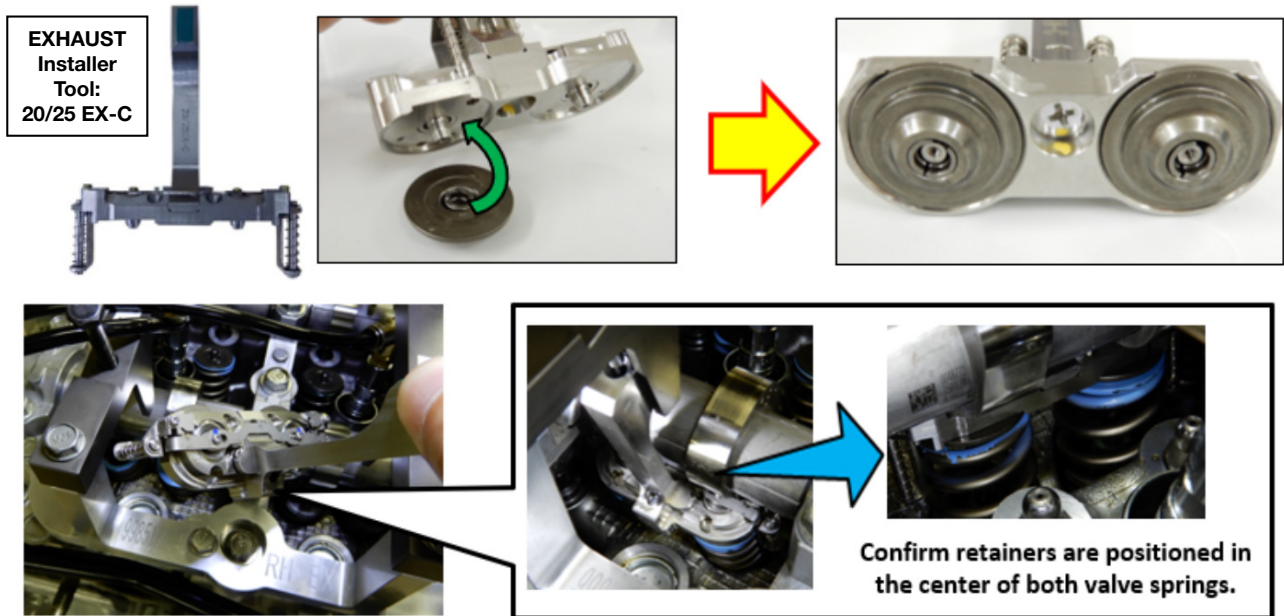

- X. Loosen the push bolt and remove the installer tool. **CAREFULLY** inspect both springs for successful, properly seated retainers and keepers. Use the reference photos in **Step T** above as a guide for confirmation. If any of the **NG** conditions shown in **Step T** exist, use the applicable spring compressor tool to remove the pair of retainers and keepers then return to **Step W** above and start over. If installation is successful, proceed to **Step Y** below.
- Y. Close the air valve and remove both air hoses from the spark plug adapters.
- Z. Rotate the crankshaft **clockwise 540 degrees** (1.5 rotations) and set **#1** piston back to TDC.
- AA. With shop air supply connected and the regulator set to 0.5MPa, connect one of the air hoses to the spark plug adapter in **#3** cylinder. **SLOWLY** (5 seconds from closed to open), open the shut-off valve. A slight amount of air leakage is normal.
- BB. Connect the other air hose to **#1** cylinder's spark plug adapter.
- CC. Replace the valve springs on **#1** cylinder following steps **M** to **Y** as outlined above.
- DD. Close the air valve and remove both air hoses from the spark plug adapters.
- EE. Reinstall the **INTAKE** rockers and shims back to **#1** cylinder. Insert compression tool **2.0/2.5 IN-A** (**WHITE** paint mark) into the corresponding bridge bracket guide slot and onto the retainers and keepers.

VERY IMPORTANT: During reassembly, always make sure the corresponding shim and rocker are reinstalled onto the valve they were removed from originally to avoid unnecessary valve clearance adjustments.

- FF. Reinstall the **EXHAUST** rockers and shims back to **#1** cylinder. Insert compression tool **2.0/2.5 EX-A** (**GREEN** paint mark) into the corresponding bridge bracket guide slot and onto the retainers and keepers.

Continued...

- GG.** Rotate the crankshaft **clockwise 180 degrees** to bring #3 piston back to TDC.
- HH.** Install #3 cylinder’s shims and rockers following the procedures in steps **FF** and **GG** above.
- II.** Remove the bridge brackets, bridge bases and spark plug adapters from the cylinder head.
- JJ.** Rotate the engine so the RH (cylinders #2 and #4) side face upward (crankcase seam horizontal).
- KK.** Replace the valve springs on cylinders #2 and #4 following the same procedures as outlined above.

NOTE: See “**APPENDIX A**” provided below for an overview of the FB Engine valve spring replacement procedures.

- LL.** When complete, recheck the valve clearance measurements to confirm all are within specifications provided in **Step 7** above. If adjustment is necessary, use the applicable tools while following the procedures supplied in this bulletin to remove the affected rockers and shims.
- MM.** After removing any remaining old sealer, reinstall the valve covers using new gaskets supplied in the parts kit following the procedures in the applicable Service Manual along with the spark plugs and ignition coils. Finish reassembly of any remaining components in reverse order of removal.

11) CAREFULLY remove the engine from the stand and re-install following the existing procedures in the applicable Service Manual.

CLAIM REIMBURSEMENT AND ENTRY PROCEDURES:

Credit to perform this recall will be based on properly completed repair order information. Retailers may submit claims through Subarunet.com.

Labor Description	Labor Operation #	Applicability	Transmission Type	Labor Time	Recall/Campaign Code	Claim Type
WTY-84 VALVE SPRING REPLACEMENT	A129-314	BRZ FA 2.0L	6AT	12.5	WTY-84	RC
			6MT			
		Impreza / Crosstrek FB 2.0L	CVT	7.3		
			6MT			
COMPLETION OF WTY-84 IN CONJUNCTION WITH A WARRANTABLE REPAIR REQUIRING ENGINE ASSEMBLY REMOVAL	A129-000*	ALL APPLICABLE MODELS	ALL	1.6		

***NOTE:** If the engine has been removed from the vehicle for any warrantable concern in addition to performing this WTY-84 recall campaign, submit the warranty claim using existing coding for the repair(s) performed and on a separate line / job, use A129-000 to claim for the WTY-84 recall portion. Contact the Claims Team with any questions regarding claim submission.

Continued...

“APPENDIX A”

(For Valve Spring replacement on cylinders #1 and #3)

FB Valve Spring Replacement Procedure Chart for cylinders #1 and #3					
Step Number	Cylinder Number	Tool Number	Tool Color	Tool Use / Function To Perform	Compressed Air / Regulator
1	1			Position engine to cylinder #1 TDC compression stroke.	
2	1 & 3			Install bridges and spark plug adapters on right side of engine.	
3	1	20/25 IN-A	White	Remove #1 INTAKE rocker arms and shims.	
4	1	20/25 EX-A	Green	Remove #1 EXHAUST rocker arms and shims.	
5	3			Rotate crankshaft clockwise 180 degrees to bring #3 to TDC.	
6	3	20/25 IN-A	White	Remove #3 INTAKE rocker arms and shims.	
7	3	20/25 EX-A	Green	Remove #3 EXHAUST rocker arms and shims.	
8	1			Connect air hose and SLOWLY apply air to #1 cylinder.	Connected
9	3			Connect air hose to #3 cylinder.	Connected
10	3	20/25 IN-B	White	Remove #3 INTAKE valve retainers and keepers.	Connected
11	3			Remove and discard original #3 INTAKE valve springs.	Connected
12	3			Install new #3 INTAKE valve springs.	Connected
13	3	20/25 IN-C	White	Install #3 INTAKE valve spring retainer and keepers.	Connected
14	3			Confirm both #3 INTAKE retainers and all 4 keepers are properly seated.	Connected
15	3	20/25 EX-B	Green	Remove #3 EXHAUST valve retainers and keepers.	Connected
16	3			Remove original #3 EXHAUST valve springs.	Connected
17	3			Install new #3 EXHAUST valve springs.	Connected
18	3	20/25 EX-C	Green	Install #3 EXHAUST valve spring retainer and keepers.	Connected
19	3			Confirm both EXHAUST retainers and all 4 keepers are properly seated.	Connected
20	1 & 3			Close air valve and remove both air hoses.	Removed
21	1			Rotate crankshaft clockwise 540 degrees (1.5 rotations) to bring #1 to TDC.	Removed
22	3			Connect air hose and SLOWLY apply air to #3 cylinder.	Connected
23	1			Connect air hose to #1 cylinder.	Connected
24	1			Repeat Steps 10 to 20 above to replace the valve springs on #1 cylinder.	Connected
25	1	20/25 IN-A	White	Install #1 INTAKE rocker arms and shims.	Connected
26	1	20/25 EX-A	Green	Install #1 EXHAUST rocker arms and shims.	Connected
27	3			Rotate crankshaft clockwise 180 degrees to bring #3 to TDC.	Removed
28	3			Repeat Steps 25 and 26 above to replace shims and rockers on #3 cylinder.	Connected
29	1 & 3			Remove bridges and spark plug adapters from right side of engine.	Removed
30	2 & 4			Rotate engine on the stand to bring cylinders #2 and #4 horizontal.	

Continued...

(For Valve Spring replacement on cylinders #2 and #4)

FB Valve Spring Replacement Procedure Chart for cylinders #2 and #4					
Step Number	Cylinder Number	Tool Number	Tool Color	Tool Use / Function To Perform	Compressed Air / Regulator
1	2			Rotate the crankshaft clockwise 180 degrees to bring cylinder #2 to TDC	
2	2 & 4			Install bridges and spark plug adapters on left side of engine.	
3	2	20/25 IN-A	White	Remove #2 INTAKE rocker arms and shims.	
4	2	20/25 EX-A	Green	Remove #2 EXHAUST rocker arms and shims.	
5	4			Rotate crankshaft clockwise 180 degrees to bring #4 to TDC.	
6	4	20/25 IN-A	White	Remove #4 INTAKE rocker arms and shims.	
7	4	20/25 EX-A	Green	Remove #4 Exhaust rocker arms and shims.	
8	2			Connect air hose and SLOWLY apply air to #2 cylinder.	Connected
9	4			Connect air hose to #4 cylinder.	Connected
10	4	20/25 IN-B	White	Remove #4 INTAKE valve retainers and keepers.	Connected
11	4			Remove and discard original #4 INTAKE valve springs.	Connected
12	4			Install new #4 INTAKE valve springs.	Connected
13	4	20/25 IN-C	White	Install #4 INTAKE valve spring retainer and keepers.	Connected
14	4			Confirm both #4 INTAKE retainers and all 4 keepers are properly seated.	Connected
15	4	20/25 EX-B	Green	Remove #4 EXHAUST valve retainers and keepers.	Connected
16	4			Remove and discard original #4 EXHAUST valve springs.	Connected
17	4			Install new #4 EXHAUST valve springs.	Connected
18	4	20/25 EX-C	Green	Install #4 EXHAUST valve spring retainer and keepers.	Connected
19	4			Confirm both #4 EXHAUST retainers and all 4 keepers are properly seated.	Connected
20	2 & 4			Close air valve and remove both air hoses.	Removed
21	2			Rotate crankshaft clockwise 540 degrees (1.5 rotations) to bring #2 to TDC.	Removed
22	4			Connect air hose and SLOWLY apply air to #4 cylinder.	Connected
23	2			Connect air hose to #2 cylinder.	Connected
24	2			Repeat Steps 10 to 20 above to replace the valve springs on #2 cylinder.	Connected
25	2	20/25 IN-A	White	Install #2 INTAKE rocker arms and shims.	Connected
26	2	20/25 EX-A	Green	Install #2 EXHAUST rocker arms and shims.	Connected
27	4			Rotate crankshaft clockwise 180 degrees to bring #4 to TDC.	Removed
28	4			Repeat Steps 25 and 26 above to replace shims and rockers on #4 cylinder.	Connected
29	2 & 4			Remove bridges and spark plug adapters from the left side of engine.	Removed

IMPORTANT REMINDERS:

- SOA strongly discourages the printing and/or local storage of service information as previously released information and electronic publications may be updated at any time.
- Always check for any open recalls or campaigns anytime a vehicle is in for servicing.
- Always refer to STIS for the latest service information before performing any repairs.

Continued...

OWNER NOTIFICATION LETTER

IMPORTANT SAFETY RECALL
This notice applies to the VIN below



Subaru of America, Inc
Subaru Plaza
PO Box 9103
Camden, NJ 08101-9877
844-373-6614
www.subaru.com

Subaru Recall WTY-84
NHTSA ID 18V-772
December 2018

Dear Subaru Owner:

This notice is sent to you in accordance with the National Traffic and Motor Vehicle Safety Act.

SUBARU OF AMERICA, INC. has decided that a defect, which relates to motor vehicle safety, exists in certain 2013 model year BRZ and XV Crosstrek and 2012-2014 model year Impreza vehicles. You received this notice because our records indicate that you currently own one of these vehicles.

REASON FOR THIS RECALL

The valve springs located inside the engine of your vehicle may fracture, which may cause an abnormal noise or engine malfunction. In the worst case, this may result in the engine stalling during driving and you may be unable to restart your vehicle. An engine stall during driving may increase the risk of a crash.

What You Should Do

You should immediately contact your Subaru retailer (dealer) for an appointment to have this important repair performed.

Important Precautions

If the condition occurs, abnormal noise or vibration may occur prior to a potential engine stall. If you hear an abnormal noise or feel a vibration, your vehicle may be experiencing symptoms related to this condition. Please pull over as safely and as quickly as possible and contact your Subaru retailer.

If your vehicle is experiencing the condition described, you may make alternative arrangements for having your vehicle towed to your retailer. Contact the Subaru Roadside Assistance Program at 1-800-261-2155.

For your convenience, your retailer will provide you a loaner or rental vehicle at no cost until your car has been repaired.

REPAIR

Subaru will replace the engine valve springs with new ones of an improved design. The repair will be performed FREE of charge.

HOW LONG WILL THE REPAIR TAKE?

The time to replace the valve springs in your vehicle is approximately 7 hours for Impreza or XV Crosstrek or 12 hours for BRZ. Because of the time required to complete the repair, it may be necessary to leave your vehicle for a longer period of time. Ask your retailer about providing you with a loaner or rental vehicle at no cost until your vehicle has been repaired.

CALIFORNIA REGISTERED OWNERS

The California Air Resources Board requires that emission related campaigns be completed prior to California's vehicle registration renewal process; without this repair, you will not be able to register your vehicle during your next annual registration. Upon completion of this campaign, your California dealer will complete and provide you a "Proof of Correction Certificate." If required, present the certificate to the California Department of Motor Vehicles (the "DMV") when renewing your California registration as proof of campaign completion. If the DMV does not request the certificate, we recommend that you keep it for your records.

In addition, the State of California requires that every vehicle must pass an emission test (SMOG Check) every two years and

Continued...

before it is sold. ***Without the service we are providing at no charge, your vehicle may not pass this test.***

CHANGED YOUR ADDRESS OR SOLD YOUR SUBARU?

If you have moved or sold your vehicle, please complete the enclosed prepaid postcard and mail it to us. Or if you prefer to update this information online, please go to www.subaru.com, select 'Customer Support,' then select 'Address Update' or 'Ownership Update' from the drop-down menu.

IF YOU HAVE PREVIOUSLY PAID FOR A REPAIR

If you have already paid for repairs associated with this condition, you may be eligible for reimbursement. Reimbursement consideration will be based on the amount an authorized Subaru retailer in your area would charge for the same repair.

Please send the original service repair order, which has the name of the repair facility, date of repair, mileage at the time of repair, complete 17-digit vehicle identification number (VIN), and your name, with correct mailing address and telephone number to the address listed below.

**Subaru of America, Inc.
Customer-Retailer Services Department, Attention: WTY-84 Recall
P.O. Box 9103, Camden, NJ 08101-9877**

Please send original receipts only and retain a photocopy for your records. Please be assured that we will attempt to process your reimbursement request as quickly as possible, but it may take up to 60 days for this process to be completed.

IF YOU NEED FURTHER ASSISTANCE:

To locate the nearest Subaru retailer, you can access our website at www.subaru.com and select 'Find a Retailer.'

For additional information, please go to: <http://www.wty84.service-campaign.com>.

If you need additional assistance, please contact us directly:

- By e-mail: Go to www.subaru.com and select "Contact Us"
- By telephone: 1-844-373-6614
- Monday through Friday between 8:00 a.m. and 7:00 p.m. ET
- By U.S. Postal mail: Write us at Subaru of America, Inc.
Attn: Customer-Retailer Services Department
P.O. Box 9103, Camden, NJ 08101-9877

To subscribe to the NHTSA Recall Notification email System, please go to: <https://www-odi.nhtsa.dot.gov/nhtsa/subscriptions>.

Please contact us immediately if the Subaru retailer fails or is unable to make the necessary repairs free of charge.

You may also contact the Administrator, National Highway Traffic Safety Administration (NHTSA), 1200 New Jersey Ave., SE, Washington, DC 20590 or call the toll-free Vehicle Safety Hotline at 1-888-327-4236 (TTY: 1-800-424-9153) or go to <http://www.safercar.gov> if you believe the Subaru retailer has failed or is unable to remedy your vehicle without charge within a reasonable amount of time.

Your continued satisfaction with your Subaru is important to us. Please understand that we have taken this action in the interest of your safety and your vehicle's proper operation. We sincerely apologize for any inconvenience this matter may cause and urge you to schedule an appointment as soon as possible.

Sincerely,
Subaru of America, Inc.

Notice to Lessors: Under Federal law the lessor of a vehicle who receives this letter must provide a copy of it to the vehicle lessee(s) within 10 business days from receipt. The lessor must also keep a record of the lessee(s) to whom this letter is sent, the date sent, and the applicable vehicle identification number (VIN). (For the purposes of this section, a lessor means a person or entity that in the last twelve months prior to the date of this notification has been the owner, as referenced on the vehicle's title, of any five or more leased vehicles. A leased vehicle is a vehicle leased to another person for a term of at least four months.)

A subsidiary of SUBARU CORPORATION