

**TECHNICAL INSTRUCTIONS**  
**FOR**  
**SAFETY RECALL J02**  
**VALVE SPRING REPLACEMENT**  
**CERTAIN 2013 MY FR-S**

**UPDATED 3/27/2019**

Update 3/27/19

- A list of Best Practices for FIPG Removal and Application on page 3
- A list of Additional Hints on page 4
- Supporting instructional video content has been added to highlight key steps during the repair process
- Added caution to cover Oil Pan opening during FIPG cleaning and to clean out blind bolt holes

Update 12/20/18

- (Pg. 20) Checksheet added to confirm repair quality

The repair quality of covered vehicles is extremely important to Toyota. All dealership technicians performing this recall are required to successfully complete the most current version of the E-Learning course “Safety Recall and Service Campaign Essentials”. To ensure that all vehicles have the repair performed correctly; technicians performing this recall repair are required to currently hold at least one of the following certification levels:

- Expert Technician (Engine)
- Master Technician
- Master Diagnostic Technician

It is the dealership’s responsibility to select technicians with the above certification level or greater to perform this recall repair. Carefully review your resources, the technician skill level, and ability before assigning technicians to this repair. It is important to consider technician days off and vacation schedules to ensure there are properly trained technicians available to perform this repair at all times.

## I. OPERATION FLOW CHART

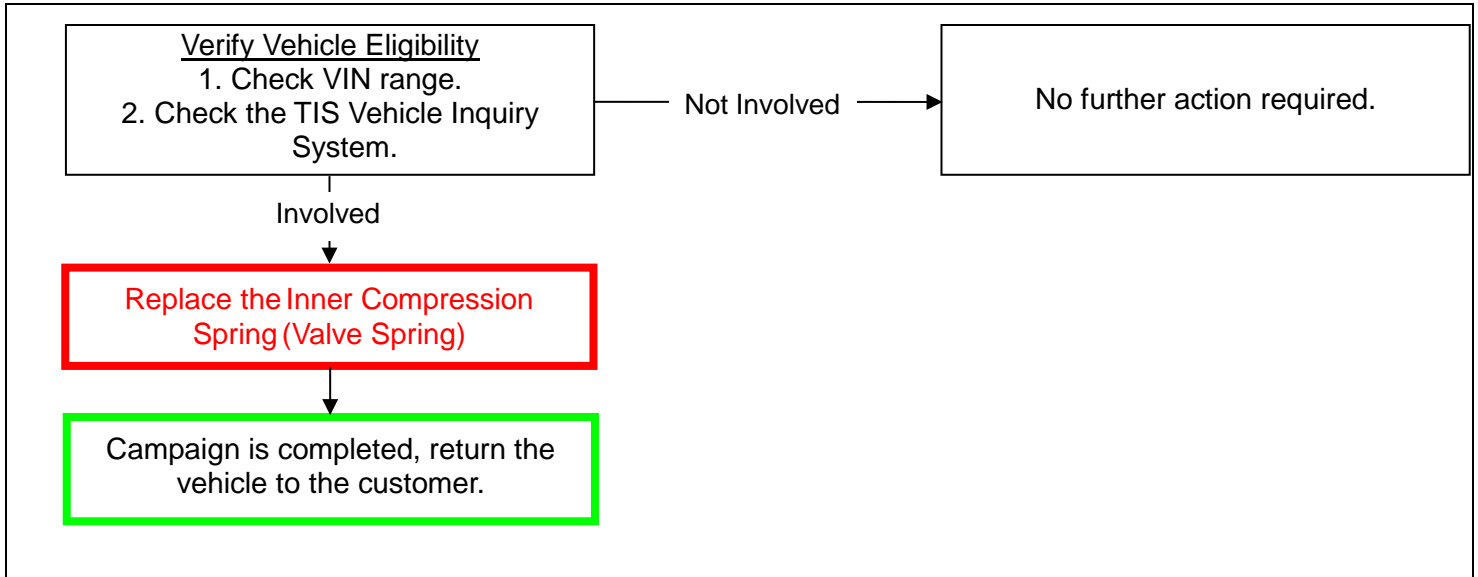

## II. IDENTIFICATION OF AFFECTED VEHICLES

- Check the TIS Vehicle Inquiry System to confirm the VIN is involved in this Safety Recall, and that the campaign has not already been completed prior to dealer shipment or by another dealer.
- TMS warranty will not reimburse dealers for repairs conducted on vehicles that are not affected or were completed by another dealer.



## Best Practices for Formed In-Place Gasket (FIPG) Service



A quality repair using FIPG requires attention to detail, cleanliness and application consistency. The following best practices should be followed to maximize sealing effectiveness and minimize contamination.

### FIPG Removal and Surface Preparation

- Thoroughly clean and degrease all areas where FIPG is applied.
- Ensure all openings that lead to the crank case or oil galleys are covered with either tape or shop towels before starting the cleaning process. This will prevent debris or pieces of original FIPG from entering the crank case or oil galleys.
- After completely cleaning the FIPG surfaces, make sure to remove all protective coverings before re-assembly.
- Do not store removed engine components below the engine when cleaning/removing original FIPG (ex: timing chains and covers). Prevent any debris from contaminating parts that will be reused.
- Remove all original or dried FIPG from any blind bolt holes to avoid damaging the camshaft caps or other fasteners.
- Use commercially available gasket removal cleaners designed to aid in removal of silicone-based sealers.
- Use a vacuum to clean out any dried FIPG or other debris that may have gotten into oil passages or other areas away from the sealing surface.
- When removing the original FIPG from the aluminum surfaces, never use metal scrapers or abrasive tools. This includes the use of abrasive type discs and powered angle grinders which can damage the aluminum sealing surface. Only use a plastic or wooden scraper.
- Avoid introducing any external contamination into the engine by ensuring your work space is clean and free of any trash and/or airborne contaminants that can land on the sealing surface.
- After removing all of the original FIPG, clean metal surfaces with alcohol, a cleaning product that will not leave a film, or use a clean, lint-free cloth.

### FIPG Application

- Practice applying the FIPG to ensure you can apply seal packing quickly and precisely as instructed (Re-useable practice sheets will be sent to each dealer).
- Ensure you do not apply too much FIPG during the assembly process. Follow the procedure outlined in the Job Aid to apply the appropriate amount.
- Although the remedy includes an allotment of 1 FIPG tube per vehicle, use of the entire tube contents is not necessary. In fact, if you use a full tube, you most likely have applied too much.
  - After reassembling the engine, allow the assembly to sit for a minimum of 2 hours before adding oil. This time helps FIPG completely cure.

## Additional Hints Before Beginning Remedy

Understanding the current state of the vehicle's powertrain and general operation of the engine can provide additional information before beginning the J02 remedy procedure.

Identify any potential pre-existing conditions with the engine prior to starting the valve spring repair process.

- Conduct a thorough road test listening for any abnormal engine noises, misfire, or other performance concerns.
- Complete a Techstream HealthCheck and confirm any stored DTCs (Current or History).
- Verify OBDII Readiness Monitor Completion status. Consider extending the road test to complete all Monitors if one or more are shown incomplete to confirm no additional or potential malfunctions.
- Before disassembly, slowly rotate engine until the oil drain plug is pointing straight down to allow any residual oil to fully drain. Closely check the drained oil looking for any signs of metal shavings that could indicate a possible pre-existing concern.

(Save or photograph any identified foreign material to share with the customer)

If any pre-existing conditions are noted prior to disassembling the vehicle, review these conditions with the customer. If necessary, explain that pre-existing conditions are not covered by this remedy and that additional diagnosis and repairs may be needed.

- Document any concerns on the RO and have the customer sign, acknowledging their vehicle may have these concerns prior to proceeding with the J02 remedy.

### III. PREPARATION

#### A. PARTS

**[for Automatic Transmission (1/3)]** Note: See the specified drawings for configurations.

Part Name		Part No.	Subaru Part No.	Qty	Drawing
SPRING-VALVE EG KIT		SU003-08061	X1321AA200	1	-
Individually Packaged Parts	Inner Compression Spring	SU003-07325	13217AA5219R	16	Fig.2_30
	Fuel Delivery Pipe No.2	SU003-00342	17540AA3409R	1	Fig.2_21
	Cylinder Head Cover Gasket	SU003-00280	13270AA2509R	1	Fig.2_27
	Cylinder Head Cover Gasket No.2	SU003-00281	13272AA1809R	1	Fig.2_28
	Front Stabilizer Link Assembly	SU003-00394	20420CA0009R	2	Fig.1_11
	Nut (Stabilizer Link)	SU003-04506	9023700639R	4	Fig.1_12
	Nut (Exhaust Manifold)	SU003-02872	9023700099R	6	Fig.1_6
A1 kit	Bolt (Cowl Brace)	SU003-02821	9010004049R	2	Fig.1_1
	Nut (Cowl Brace)	SU003-02885	9023700629R	6	Fig.1_2
	Bolt (Body Mounting Cushion)	SU003-02801	9010003529R	6	Fig.1_9
	Bolt (Body Mounting Cushion)	SU003-02816	9010003919R	2	Fig.1_10
B kit	Spark Plug Tube Gasket	SU003-06775	10966AA0409R	4	Fig.2_29
	Crank Shaft (Timing Chain or Belt Cover) Oil Seal	SU003-02180	8067500809R	1	Fig.2_17
	Exhaust Manifold to Head Gasket	SU003-01111	44022AA0209R	2	Fig.1_5
C kit	Oil Pan Drain Plug Gasket	SU003-02159	8039160109R	1	Fig.1_8
	Crank Shaft Pulley O-ring	SU003-02190	8069390609R	1	Fig.2_16
	Timing Gear Case Lower O-ring	SU003-02186	8069241209R	1	Fig.2_24
	Timing Gear Case Upper O-ring	SU003-02183	8069121909R	3	Fig.2_25
	Oil Level Dipstick Guide O-ring	SU003-00306	15090KA0009R	1	Fig.2_15
	O-ring (Vacuum Pump)	SU003-02184	8069151709R	1	Fig.2_23
	Chain Tensioner O-ring	SU003-02185	8069160809R	1	Fig.2_26
	O-ring (High Pressure Pump)	SU003-02187	8069311109R	1	Fig.2_22
	Fuel Injector Seal (No.2)	SU003-00324	16608KA0009R	2	Fig.2_18
	Fuel Injector Grommet	SU003-00317	16395AA0209R	2	Fig.2_19
	Fuel Injector O-ring (No.2)	SU003-00335	16698AA1109R	2	Fig.2_20
	O-ring (Discharge Hose)	SU003-A0025	73796KC0209R	1	Fig.1_3
D1 kit	Throttle Body Gasket	SU003-00316	16175AA4209R	1	Fig.1_4
	Radiator Drain Cock Packing	SU003-01196	45167TC0009R	1	Fig.1_7
	Clip (Under Cover)	SU003-02984	9091400079R	4	Fig.1_13
	Clip (Under Cover)	SU003-02989	9091400659R	9	Fig.1_14
	Clip (Wire Harness)	SU003-06476	31759KA0309R	3	Fig.2_31
	Clip (Wire Harness)	SU003-06475	31759AA0309R	4	Fig.2_32

# 【for Automatic Transmission (2/3)】

Part Name		Part No.	Subaru Part No.	Qty	Remarks
SPRING-VALVE EG KIT		SU003-08061	X1321AA200	1	-
Component	1 Bolt (Cowl Brace)	SU003-02821	9010004049R	2	
	2 Nut (Cowl Brace)	SU003-02885	9023700629R	6	
	3 O-ring (Discharge Hose)	SU003-A0025	73796KC0209R	1	OD 15.6 mm (0.61 in.)
	4 Throttle Body Gasket	SU003-00316	16175AA4209R	1	
	5 Exhaust Manifold to Head Gasket	SU003-01111	44022AA0209R	2	
	6 Nut (Exhaust Manifold)	SU003-02872	9023700099R	6	
	7 Radiator Drain Cock Packing	SU003-01196	1	ID 6.8 mm (0.27 in.)	
	8 Oil Pan Drain Plug Gasket	SU003-02159	8039160109R	1	
	9 Bolt (Body Mounting Cushion)	SU003-02801	9010003529R	6	
	10 Bolt (Body Mounting Cushion)	SU003-02816	9010003919R	2	
	11 Front Stabilizer Link Assembly	SU003-00394	20420CA0009R	2	
	12 Nut (Stabilizer Link)	SU003-04506	9023700639R	4	
	13 Clip (Under Cover)	SU003-02984	9091400079R	4	
	14 Clip (Under Cover)	SU003-02989	9091400659R	9	

Fig.1:

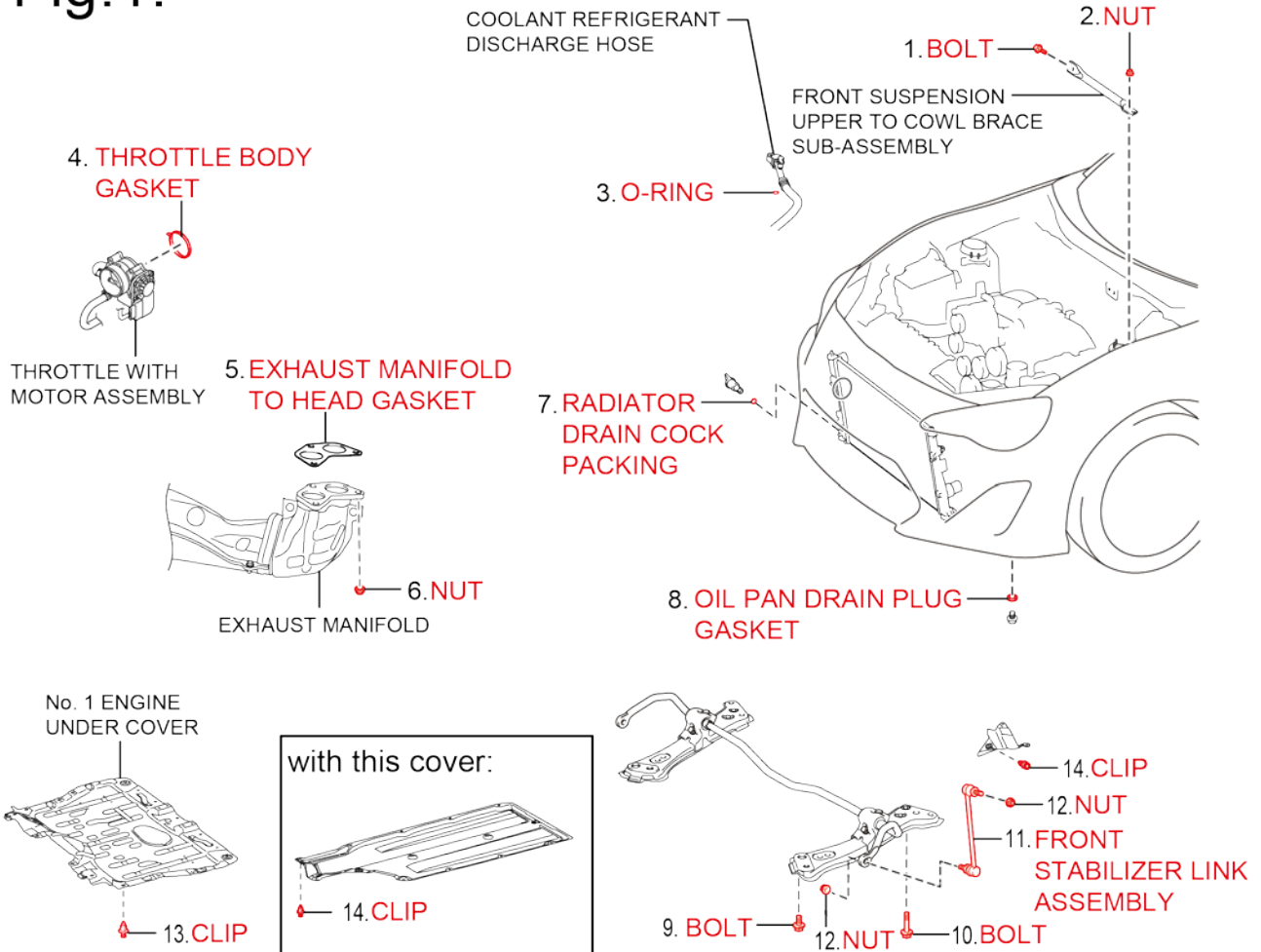

S89734bS

# 【for Automatic Transmission (3/3)】

Part Name		Part No.	Subaru Part No.	Qty	Remarks	
SPRING-VALVE EG KIT		SU003-08061	X1321AA200	1	-	
Component	15	Oil Level Dipstick Guide O-ring	SU003-00306	15090KA0009R	1	OD 13.4 mm (0.53 in.)
	16	Crank Shaft Pulley O-ring	SU003-02190	8069390609R	1	OD 43.0 mm (1.69 in.)
	17	Crank Shaft (Timing Chain or Belt Cover) Oil Seal	SU003-02180	8067500809R	1	
	18	Fuel Injector Seal (No.2)	SU003-00324	16608KA0009R	2	OD 16.0 mm (0.63 in.)
	19	Fuel Injector Grommet	SU003-00317	16395AA0209R	2	Spare Parts
	20	Fuel Injector O-ring (No.2)	SU003-00335	16698AA1109R	2	Spare Parts OD 11.6 mm (0.45 in.)
	21	Fuel Delivery Pipe No.2	SU003-00342	17540AA3409R	1	
	22	O-ring (High Pressure Pump)	SU003-02187	8069311109R	1	OD 35.5 mm (1.4 in.)
	23	O-ring (Vacuum Pump)	SU003-02184	8069151709R	1	OD 19.0 mm (0.75 in.)
	24	Timing Gear Case Lower O-ring	SU003-02186	8069241209R	1	OD 29.4 mm (1.16 in.)
	25	Timing Gear Case Upper O-ring	SU003-02183	8069121909R	3	OD 17.3 mm (0.68 in.)
	26	Chain Tensioner O-ring	SU003-02185	8069160809R	1	OD 20.7 mm (0.81 in.)
	27	Cylinder Head Cover Gasket	SU003-00280	13270AA2509R	1	
	28	Cylinder Head Cover Gasket No.2	SU003-00281	13272AA1809R	1	
	29	Spark Plug Tube Gasket	SU003-06775	10966AA0409R	4	
	30	Inner Compression Spring	SU003-07325	13217AA5219R	16	
31	Clip (Wire Harness)	SU003-06476	31759KA0309R	3		
32	Clip (Wire Harness)	SU003-06475	31759AA0309R	4		

**Fig.2:**

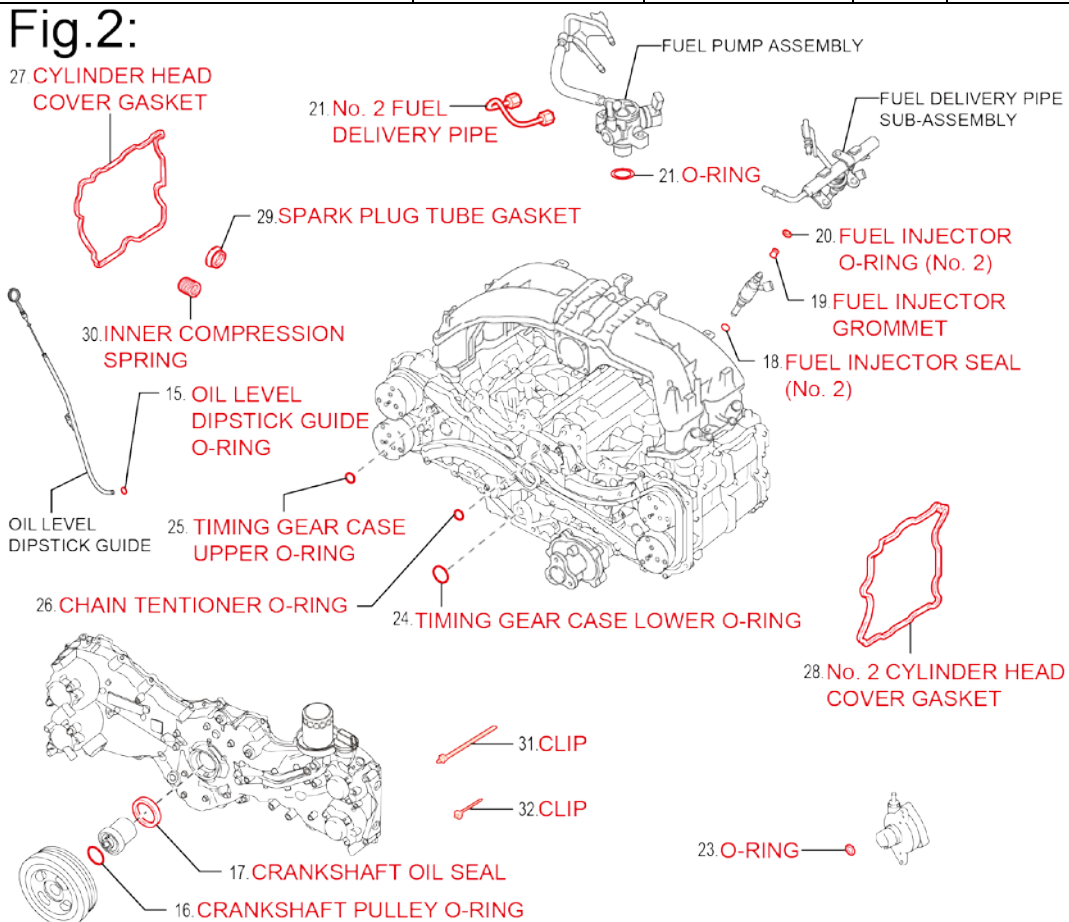

S89735bS

**[for Manual Transmission (1/3)]** Note: See the specified drawings for configurations.

Part Name		Part No.	Subaru Part No.	Qty	Drawing
SPRING-VALVE EG KIT		SU003-08062	X1321AA210	1	-
Individually Packaged Parts	Inner Compression Spring	SU003-07325	13217AA5219R	16	Fig.4_24
	Fuel Delivery Pipe No.2	SU003-00342	17540AA3409R	1	Fig.4_16
	Cylinder Head Cover Gasket	SU003-00280	13270AA2509R	1	Fig.4_21
	Cylinder Head Cover Gasket No.2	SU003-00281	13272AA1809R	1	Fig.4_22
	Nut (Exhaust Manifold)	SU003-02872	9023700099R	6	Fig.3_6
A2 kit	Bolt (Cowl Brace)	SU003-02821	9010004049R	2	Fig.3_1
	Nut (Cowl Brace)	SU003-02885	9023700629R	6	Fig.3_2
B kit	Spark Plug Tube Gasket	SU003-06775	10966AA0409R	4	Fig.4_23
	Crank Shaft (Timing Chain or Belt Cover) Oil Seal	SU003-02180	8067500809R	1	Fig.4_12
	Exhaust Manifold to Head Gasket	SU003-01111	44022AA0209R	2	Fig.3_5
C2 kit	Oil Pan Drain Plug Gasket	SU003-02159	8039160109R	1	Fig.3_8
	Crank Shaft Pulley O-ring	SU003-02190	8069390609R	1	Fig.4_11
	Timing Gear Case Lower O-ring	SU003-02186	8069241209R	1	Fig.4_18
	Timing Gear Case Upper O-ring	SU003-02183	8069121909R	3	Fig.4_19
	Oil Level Dipstick Guide O-ring	SU003-00306	15090KA0009R	1	Fig.4_10
	Chain Tensioner O-ring	SU003-02185	8069160809R	1	Fig.4_20
	O-ring (High Pressure Pump)	SU003-02187	8069311109R	1	Fig.4_17
	Fuel Injector Seal (No.2)	SU003-00324	16608KA0009R	2	Fig.4_13
	Fuel Injector Grommet	SU003-00317	16395AA0209R	2	Fig.4_14
	Fuel Injector O-ring (No.2)	SU003-00335	16698AA1109R	2	Fig.4_15
	O-ring (Discharge Hose)	SU003-A0025	73796KC0209R	1	Fig.3_3
D2 kit	Throttle Body Gasket	SU003-00316	16175AA4209R	1	Fig.3_4
	Radiator Drain Cock Packing	SU003-01196	45167TC0009R	1	Fig.3_7
	Clip (Under Cover)	SU003-02984	9091400079R	4	Fig.3_9
	Clip (Wire Harness)	SU003-06476	31759KA0309R	3	Fig.4_25
	Clip (Wire Harness)	SU003-06475	31759AA0309R	4	Fig.4_26



## 【for Manual Transmission (2/3)】

Part Name		Part No.	Subaru Part No.	Qty	Remarks
SPRING-VALVE EG KIT		SU003-08062	X1321AA210	1	-
Component	1 Bolt (Cowl Brace)	SU003-02821	9010004049R	2	
	2 Nut (Cowl Brace)	SU003-02885	9023700629R	6	
	3 O-ring (Discharge Hose)	SU003-A0025	73796KC0209R	1	OD 15.6 mm (0.61 in.)
	4 Throttle Body Gasket	SU003-00316	16175AA4209R	1	
	5 Exhaust Manifold to Head Gasket	SU003-01111	44022AA0209R	2	
	6 Nut (Exhaust Manifold)	SU003-02872	9023700099R	6	
	7 Radiator Drain Cock Packing	SU003-01196	1	ID 6.8 mm (0.27 in.)	
	8 Oil Pan Drain Plug Gasket	SU003-02159	8039160109R	1	
	9 Clip (Under Cover)	SU003-02984	9091400079R	4	

Fig.3:

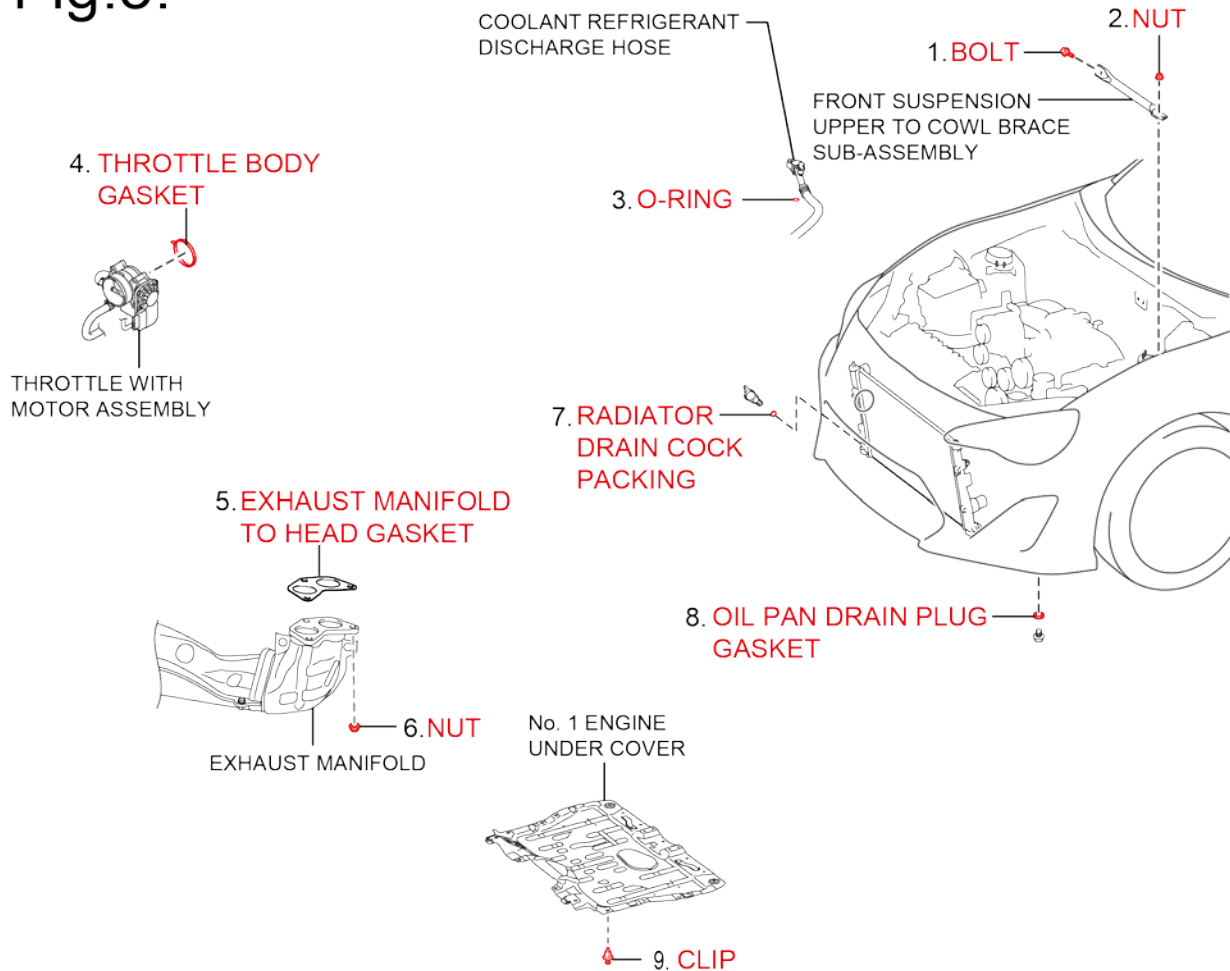

S89736bS

# 【for Manual Transmission (3/3)】

Part Name		Part No.	Subaru Part No.	Qty	Remarks	
SPRING-VALVE EG KIT		SU003-08062	X1321AA210	1	-	
Component	10	Oil Level Dipstick Guide O-ring	SU003-00306	15090KA0009R	1	OD 13.4 mm (0.53 in.)
	11	Crank Shaft Pulley O-ring	SU003-02190	8069390609R	1	OD 43.0 mm (1.69 in.)
	12	Crank Shaft (Timing Chain or Belt Cover) Oil Seal	SU003-02180	8067500809R	1	
	13	Fuel Injector Seal (No.2)	SU003-00324	16608KA0009R	2	OD 16.0 mm (0.63 in.)
	14	Fuel Injector Grommet	SU003-00317	16395AA0209R	2	Spare Parts
	15	Fuel Injector O-ring (No.2)	SU003-00335	16698AA1109R	2	Spare Parts OD 11.6 mm (0.45 in.)
	16	Fuel Delivery Pipe No.2	SU003-00342	17540AA3409R	1	
	17	O-ring (High Pressure Pump)	SU003-02187	8069311109R	1	OD 35.5 mm (1.4 in.)
	18	Timing Gear Case Lower O-ring	SU003-02186	8069241209R	1	OD 29.4 mm (1.16 in.)
	19	Timing Gear Case Upper O-ring	SU003-02183	8069121909R	3	OD 17.3 mm (0.68 in.)
	20	Chain Tensioner O-ring	SU003-02185	8069160809R	1	OD 20.7 mm (0.81 in.)
	21	Cylinder Head Cover Gasket	SU003-00280	13270AA2509R	1	
	22	Cylinder Head Cover Gasket No.2	SU003-00281	13272AA1809R	1	
	23	Spark Plug Tube Gasket	SU003-06775	10966AA0409R	4	
	24	Inner Compression Spring	SU003-07325	13217AA5219R	16	
25	Clip (Wire Harness)	SU003-06476	31759KA0309R	3		
26	Clip (Wire Harness)	SU003-06475	31759AA0309R	4		

**Fig 4:**

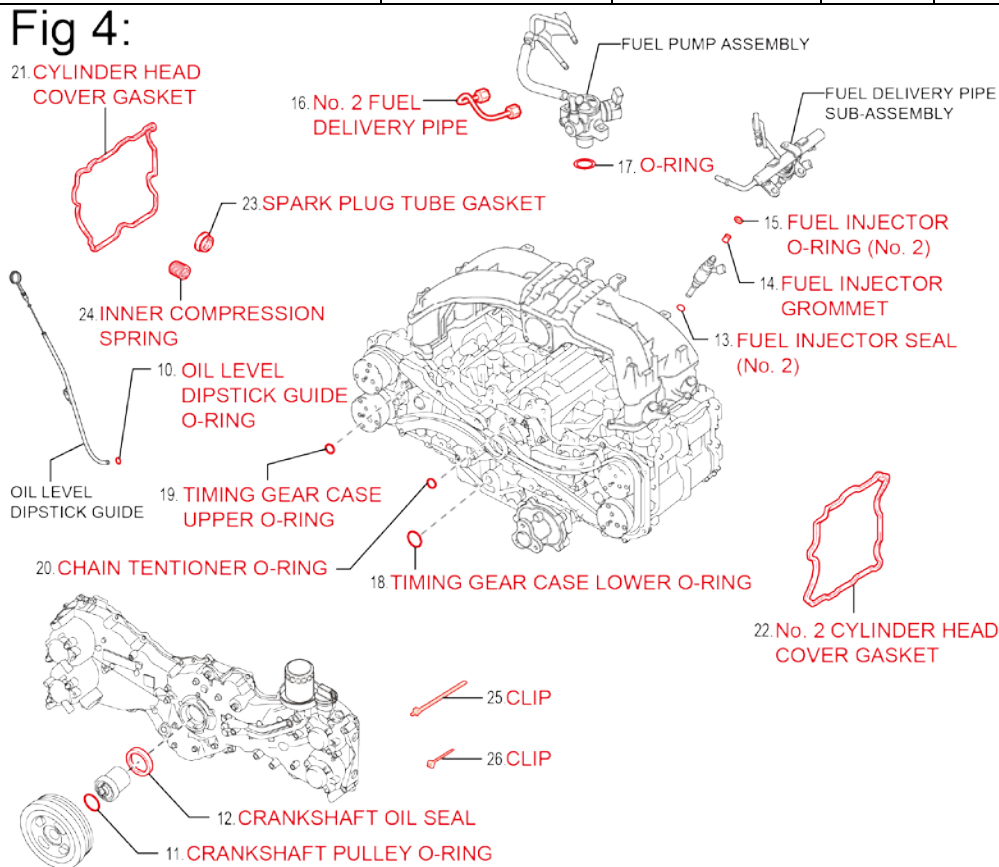

S89737bS

## B. TOOLS & EQUIPMENT

- Standard hand tools
- Engine Sling Device
- Hexagon Wrench 3.0 mm (0.12 in.)
- Socket Hexagon 6 mm (0.24 in.)
- Radiator Cap Tester
- Hose (  $\phi$  8.0 mm (0.31 in.) inner diameter)
- Sealer Application Practice Sheet
- Techstream
- Mini Crane
- Hexagon Wrench 2.5 mm (0.01 in.)
- Union Nut Wrench 17 mm (0.67 in.)
- Protective Gloves
- Refrigerant Recovery Unit
- Engine Stand
- Sealer Gun
- Torque Wrench
- Garage Jack
- Socket Hexagon 5 mm (0.2 in.)
- Halogen Leak Detector
- Protective Glasses
- Bolt (For use on the engine stand)
- Tray

SST – These are essential special service tools that the dealership should have.

Part No.	Part Name	Quantity
09960-10010	Variable Pin Wrench Set* <sup>1</sup>	1
09950-60010	Replacer Set* <sup>2</sup>	1
09950-70010	Handle Set* <sup>3</sup>	1
SU003-03936	Fuel Hole Puller	1

\*<sup>1</sup>: The set above includes the following tools.

Part No.	Part Name	Quantity
09962-01000	Variable Pin Wrench Arm Assembly	1
09963-00700	Pin 7	2
09963-01000	Pin 10	2



\*<sup>2</sup>: The set above includes the following tools.

Part No.	Part Name	Quantity
09951-00490	Replacer 49	1
09951-00650	Replacer 65	1
09952-06010	Adapter	1

\*<sup>3</sup>: The set above includes the following tools.

Part No.	Part Name	Quantity
09951-07100	Handle 100	1

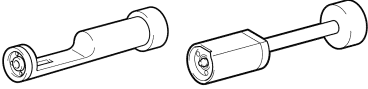
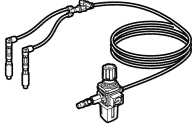
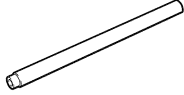
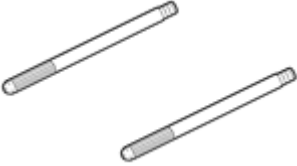
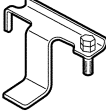
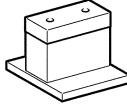
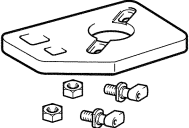
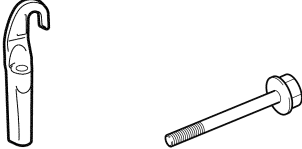
## C. INNER COMPRESSION SPRING (VALVE SPRING) REPLACEMENT TOOL SET

<p><b>Valve Spring Remover &amp; Replacer</b> Application: For removal and reinstallation of retainer locks.</p>	<p><b>Pressure Holding Tool</b> Application: Pressure Holding tool</p>	<p><b>Retainer Lock Check Tool</b> Application: For checking the retainer lock assembly</p>
		
<p><b>Guide Bolt (1 set of 2 pieces)</b> Application: For rear cylinder head plate (only for Manual Transmission) and timing chain or belt cover assembly reinstallation</p>	<p><b>Torque Converter Stopper</b> Application: For fastening the torque converter</p>	<p><b>Transmission Support Attachment</b> Application: For supporting the transmission assembly</p>
		
<p><b>Crank Pulley Tool</b> Application: For holding the crank shaft pulley in place</p>	<p><b>Engine hanger and bolt</b> Application: For engine lifting</p>	<p><b>Magnet Sheet (1 set of 2 pieces)</b> Application: For protection of painted surfaces inside the engine compartment</p>
		

## D. MATERIALS

- Cloth
- Marker Pen
- Rope
- Protective Tape
- Wire  $\phi$  1.0 mm (0.04 in.) or Paper Clip

- **FIPG Sealant.**

P/N: 00295-1217H (150 g / package).

*Dealers can claim up to one tube per vehicle. However, one tube per vehicle should not be needed for actual repair. If one entire tube is being used per vehicle there is most likely over application occurring during the repair.*

- **Toyota Super Long Life Coolant Blue.**

P/N: 00272-GTBC1.

M/T Transmission vehicles – up to 7.6 qts (7.2 liters).

A/T Transmission vehicles – up to 7.9 qts (7.5 liters).

- **Genuine Toyota Genuine Motor Oil (0W-20).**

5.8 qts (5.5 liters).

- **Refrigerant HFC-134a (R134a)**

**Note:** Note that only Genuine Toyota motor oil and Genuine Toyota Super Long Life Coolant Blue will be accepted by the warranty system. Additionally, only P/N 00295-1217H will be accepted for FIPG Sealant.

## IV. BACKGROUND

The valve springs located inside the engine of the affected vehicles may fracture, which may cause an abnormal noise or engine malfunction. In the worst case, this may result in the engine stalling during driving and the inability to restart the vehicle. An engine stall while driving at higher speeds could increase the risk of a crash.

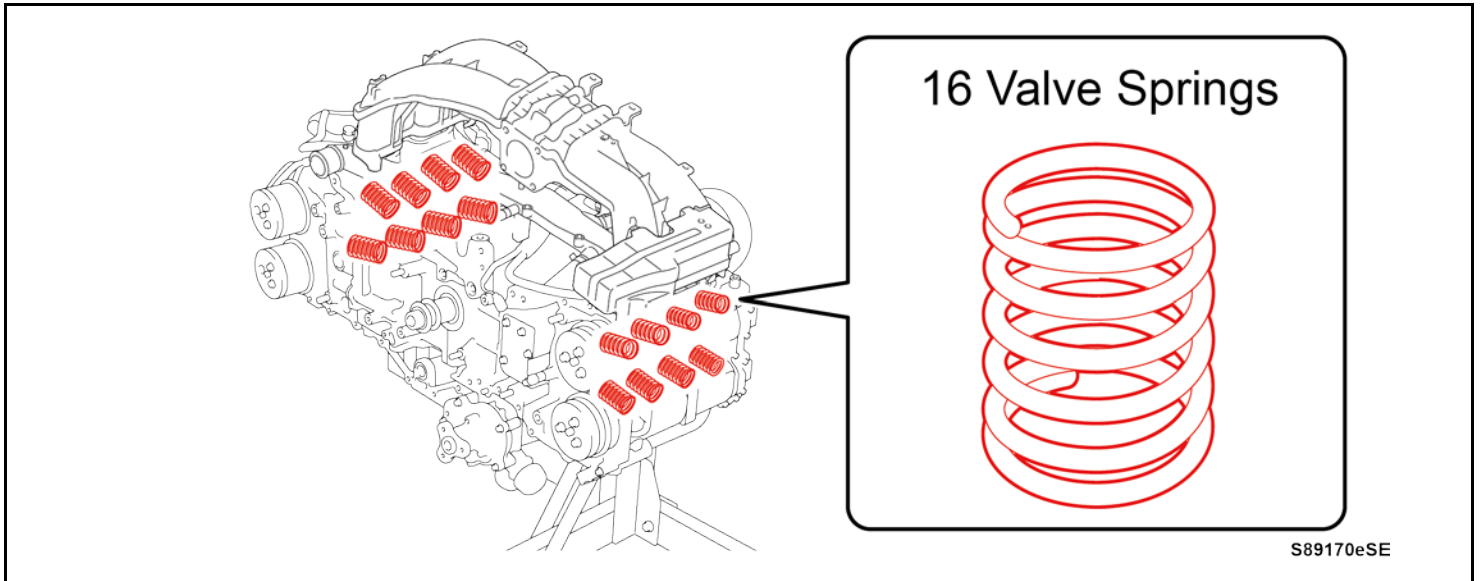

# V. WORK PROCEDURE

## A. COMPONENTS

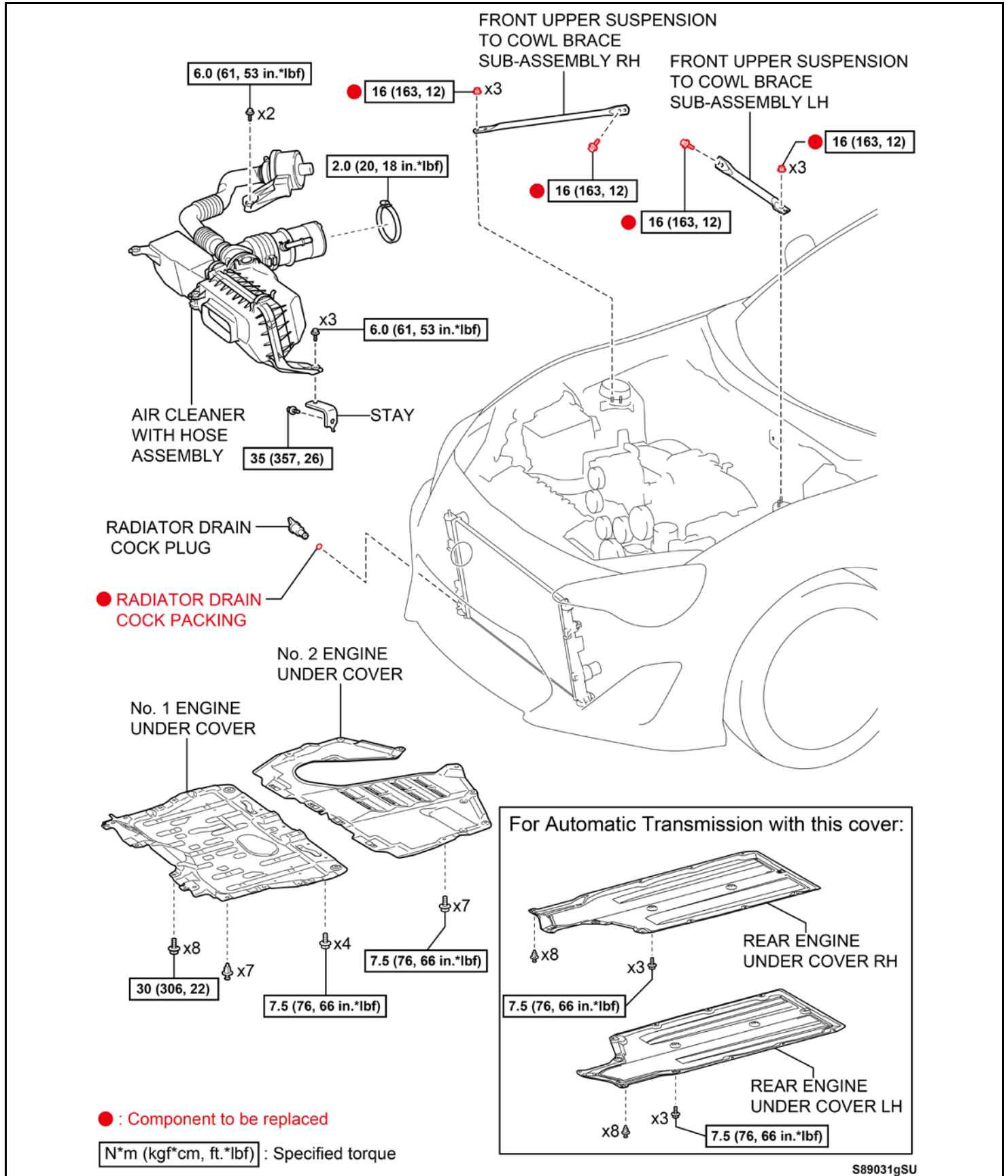

S89031gSU

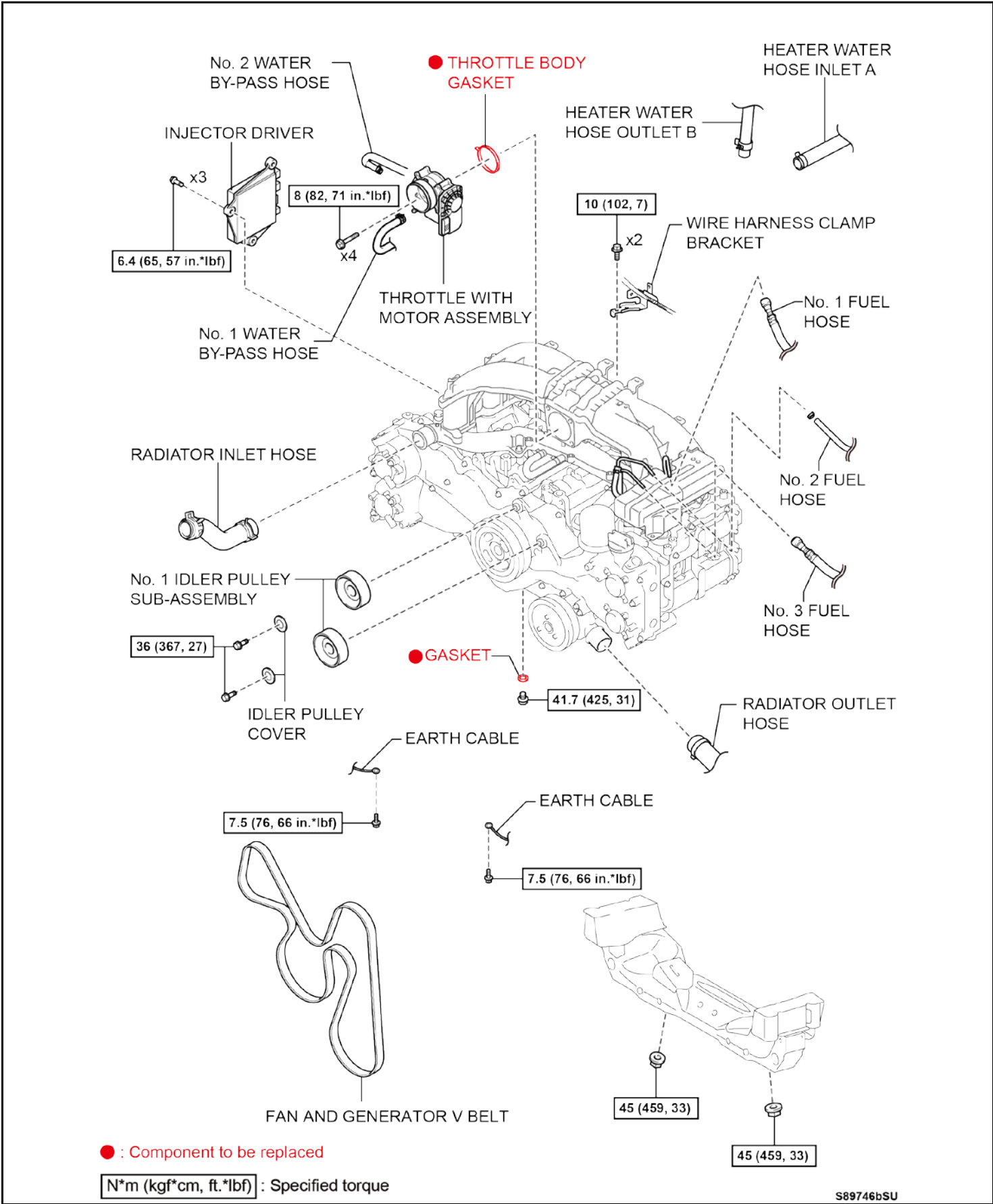

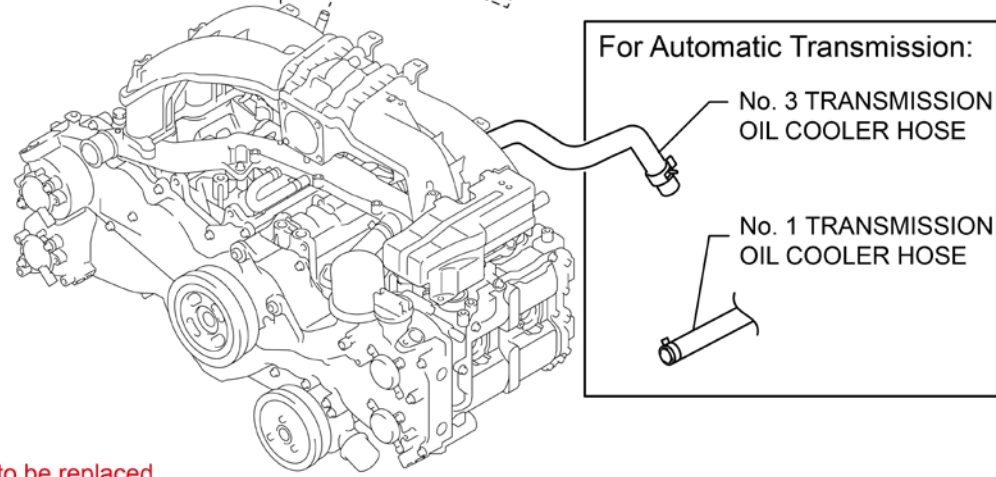
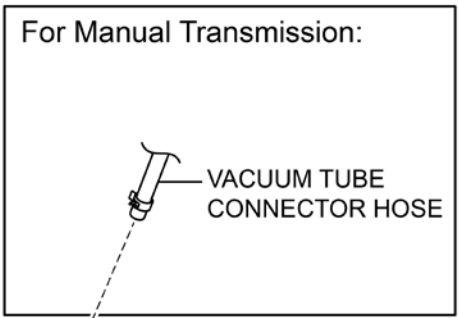
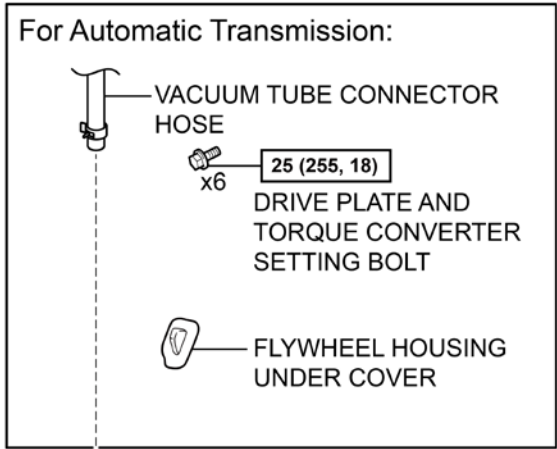
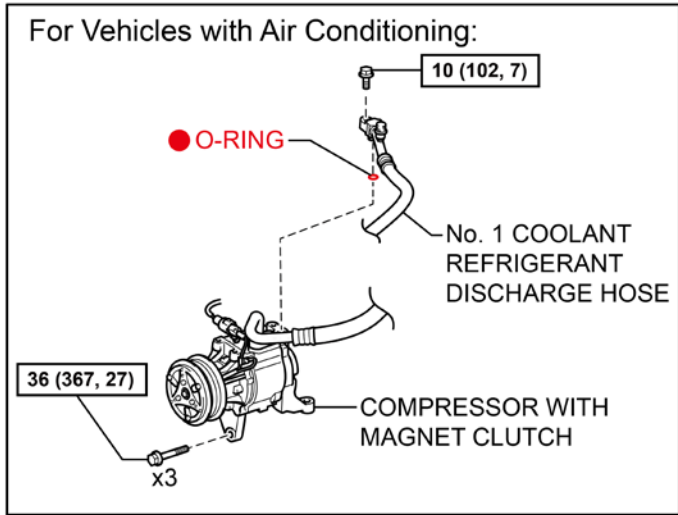
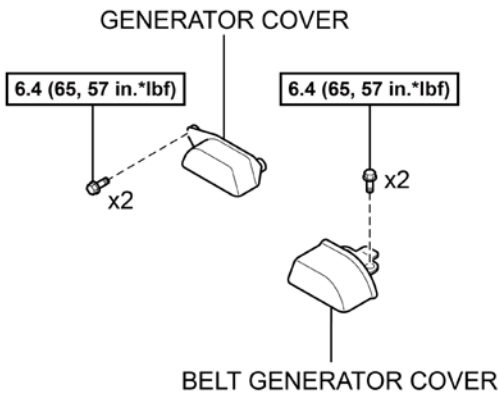

● : Component to be replaced

[N\*m (kgf\*cm, ft.\*lbf)] : Specified torque



For Automatic Transmission:

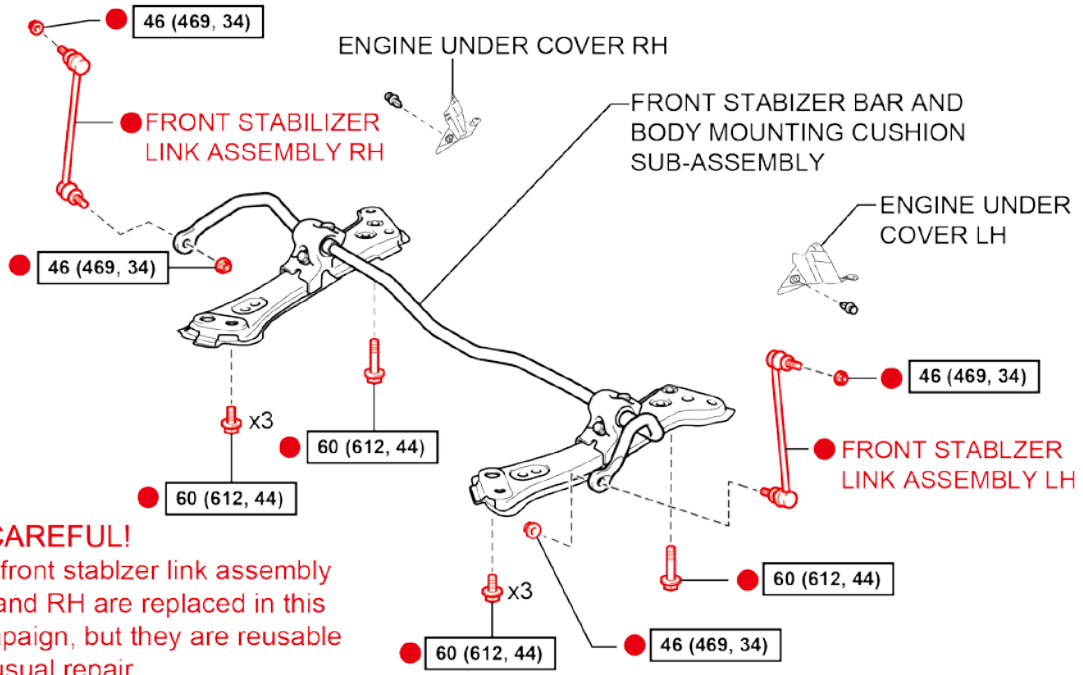

**BE CAREFUL!**

\*The front stabilizer link assembly LH and RH are replaced in this campaign, but they are reusable for usual repair.

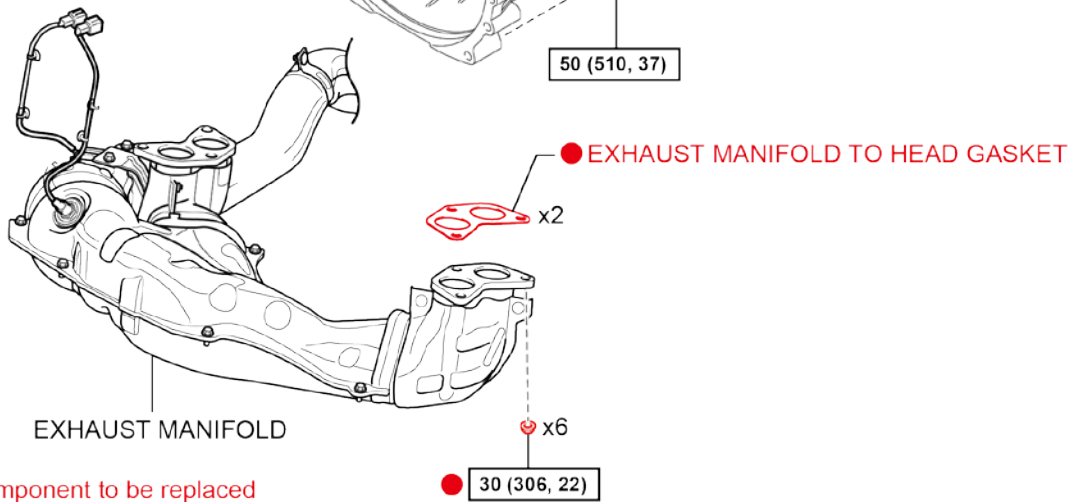
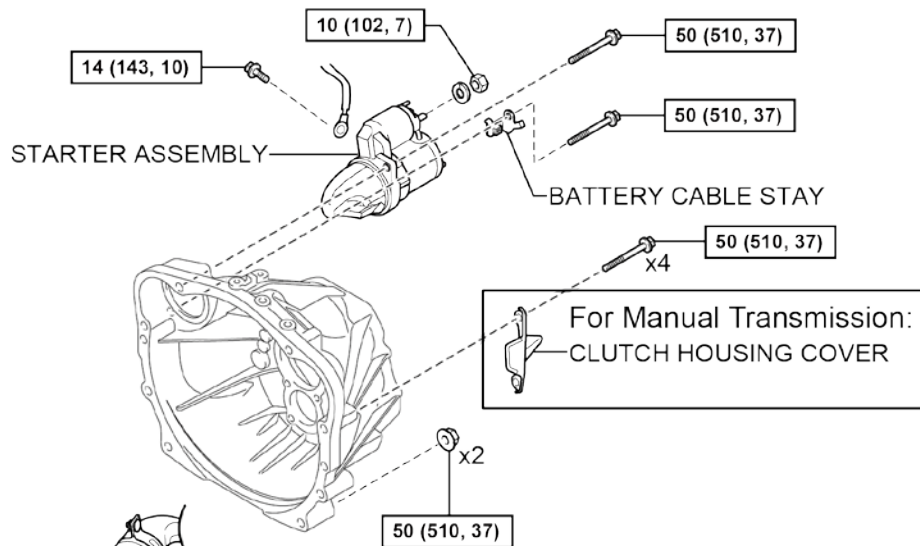

● : Component to be replaced

**N\*m (kgf\*cm, ft.\*lbf)** : Specified torque

S89033FSU

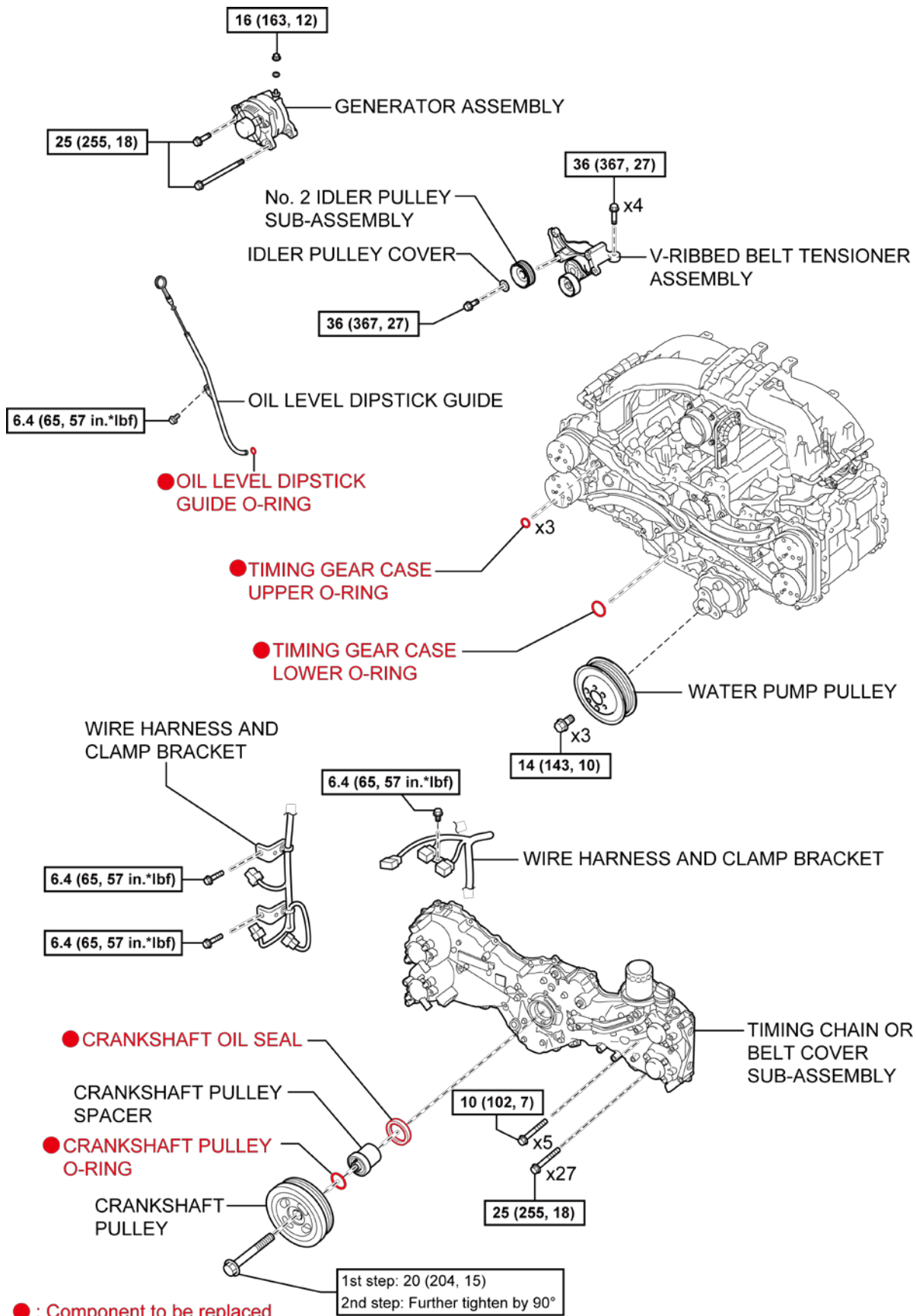

S89034dOU

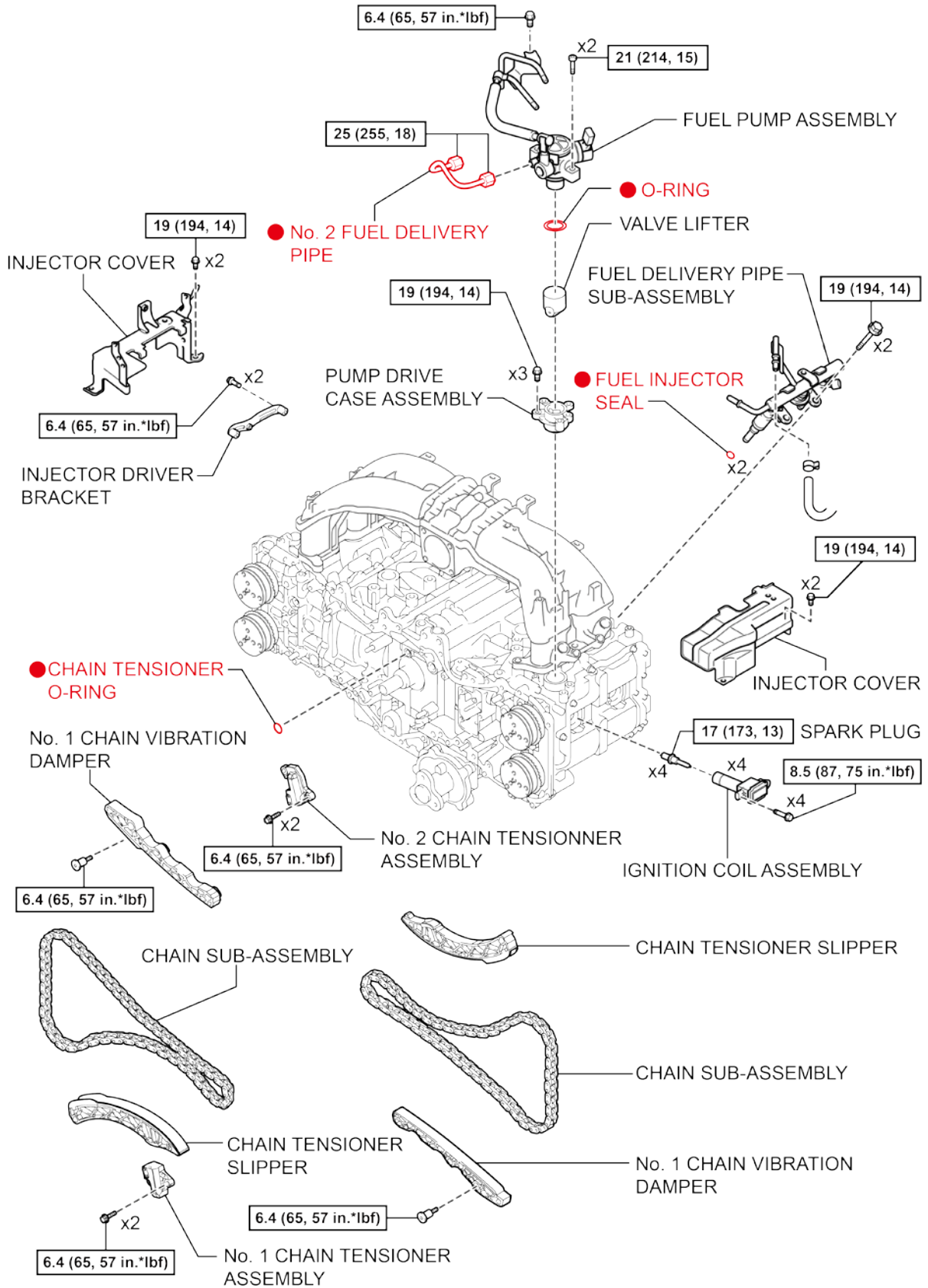

● : Component to be replaced

**N\*m (kgf\*cm, ft.\*lbf)** : Specified torque

S89035cOU

[RH Bank]

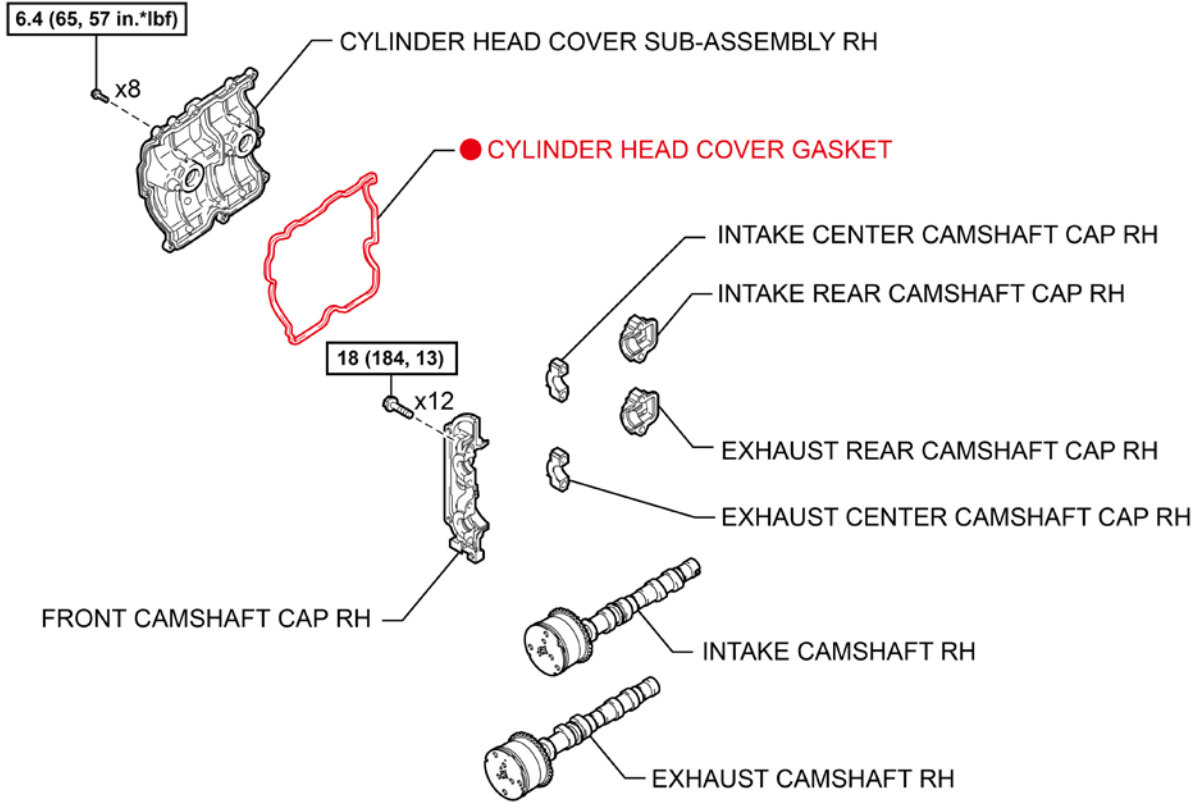

● SPARK PLUG TUBE GASKET

x2 VALVE SPRING RETAINER LOCK

x16 VALVE SPRING RETAINER

● INNER COMPRESSION SPRING x8

x8 VALVE SPRING SEAT

x8 No. 1 VALVE ROCKER ARM SUB-ASSEMBLY

x8 VALVE ADJUSTING SHIM

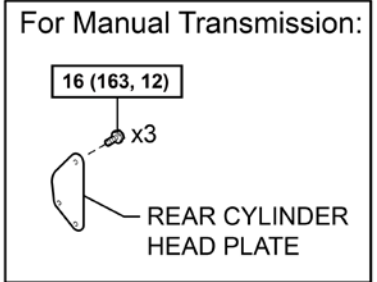
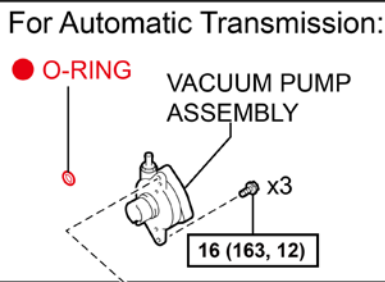

● : Component to be replaced

[N\*m (kgf\*cm, ft.\*lbf)] : Specified torque

[LH Bank]

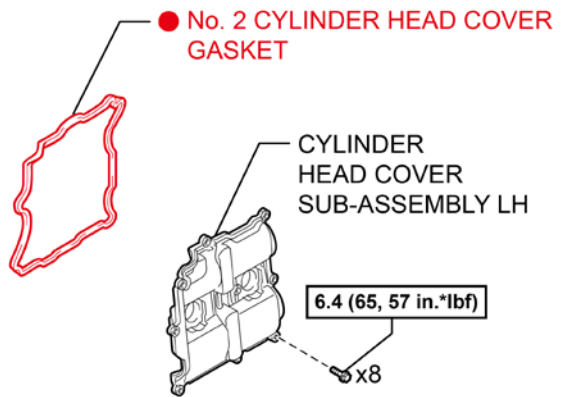
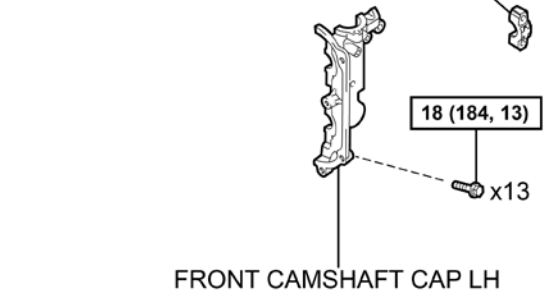
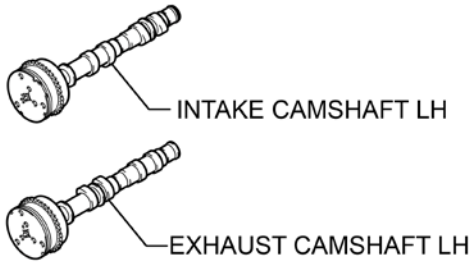
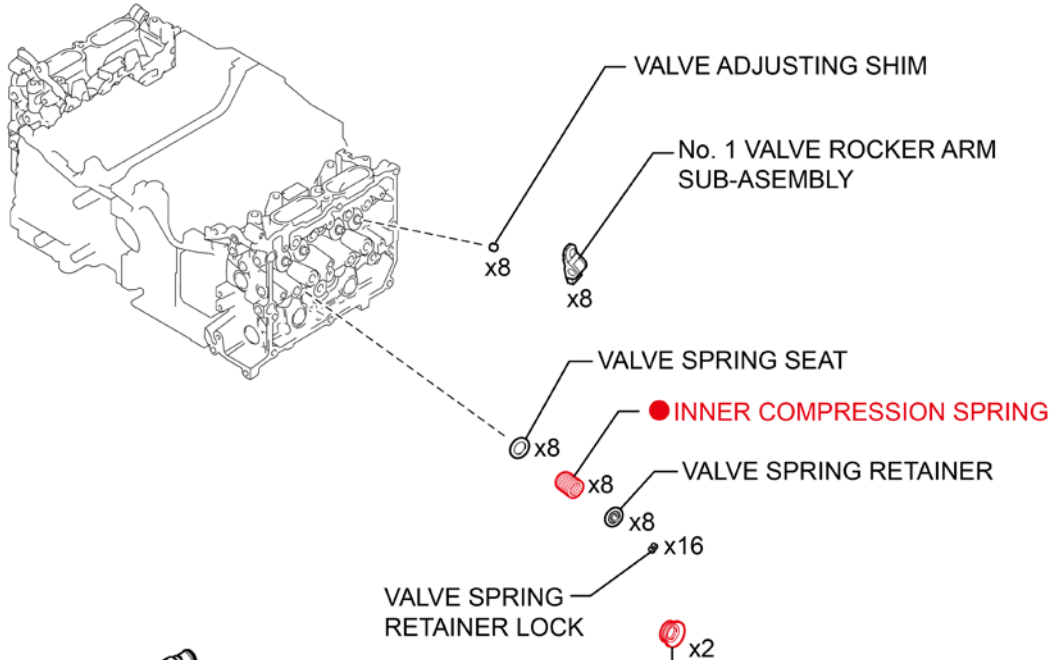

● : Component to be replaced

N\*m (kgf\*cm, ft.\*lbf) : Specified torque

## VI. PREP BEFORE BEGINNING WORK

Click the link below to access a Quick Training Guide on how to properly set timing in FR-S engines. Complete the Quick Training Guide before your first repair

[FR-S FA20 Engine Timing QTG](#)

### J02 VALVE SPRING REPAIR CHECKSHEET

Below is a checklist to be completed by another Expert Drivetrain/Engine, Master, or MDT technician other than the one performing the repair to ensure certain critical steps are performed properly. This page should be printed and attached to the R.O. for record keeping.

- Confirm RH side valve springs are properly installed, and the keepers are in place by using the check tool
  
- Confirm the seal packing has been applied properly to RH side camshaft caps focusing on...
  - Application location
  - Proper Thickness
  
- Confirm cam caps have been properly torqued
  
- Confirm the seal packing has been applied properly to the RH valve cover gasket
  
- Confirm LH side valve springs are properly installed, and the keepers are in place by using the check tool
  
- Confirm the seal packing has been applied properly to LH side camshaft caps focusing on...
  - Application location
  - Proper Thickness
  
- Confirm cam caps have been properly torqued
  
- Confirm the seal packing has been applied properly to the LH valve cover gasket
  
- Confirm that the timing chain has been properly installed. Rotate the engine multiple times to ensure proper timing has been achieved
  
- Confirm seal packing has been applied properly to the timing cover

\_\_\_\_\_  
Signature of Technician Performing Work

\_\_\_\_\_  
Signature of Technician Performing Check Off

## VII. REMOVAL OF ENGINE ACCESSORIES



It is recommended the vehicle be test driven before disassembly to confirm the engine operates as designed with no abnormalities (e.g. smoke from exhaust, engine noise, fluid leak(s), A/C system operation, etc.)

Any issues or concerns found with the vehicle should be discussed with the customer BEFORE proceeding with the repair

1. RECORD CUSTOMER SETTINGS
2. CHECK FOR DTCS
3. TAKE MEASURES AGAINST SECURITY OF NAVIGATION SYSTEM
4. SET HOOD ASSEMBLY TO COMPLETELY OPEN
5. RECOVER REFRIGERANT FROM REFRIGERATION SYSTEM (w/ Air Conditioning System)  
[Refer to TIS for instructions on how to Recover Refrigerant From Refrigeration System \(w/ Air Conditioning System\)](#)
6. DISCHARGE FUEL SYSTEM PRESSURE  
[Refer to TIS for instructions on how to Discharge Fuel System Pressure](#)
7. DISPLAY “NO FIRES” SIGN
  - a) For safety, attach the “NO FIRES” sign on the vehicle in a place where it can be clearly seen. (Use a copy of the sign on the next page.)

■ Copy And Display When Working

**WORKING WITH  
FUEL**

**NO FIRES  
NO IGNITION  
SOURCES**

Supervisor



## 8. REMOVE FUEL TANK CAP ASSEMBLY



**DO NOT** reinstall the cap until instructed to prevent fuel leakage caused by a pressure rise inside the fuel tank.

## 9. FULLY OPEN DRIVER AND PASSENGER SIDE WINDOWS



Be sure to fully open the windows, as they are provided with a mechanism that electrically crimps the glass to the weatherstrip when the window is completely closed.

Damage to the weatherstrip may occur when a door is opened or closed while the window is completely closed, if this mechanism does not operate due to disconnection of the battery.

## 10. DISCONNECT CABLE FROM BATTERY NEGATIVE TERMINAL

## 11. DRAIN ENGINE OIL

## 12. DRAIN ENGINE COOLANT

## 13. REMOVE FRONT SUSPENSION UPPER TO COWL BRACE SUB-ASSEMBLIES RH AND LH

## 14. REMOVE AIR CLEANER CAP WITH AIR CLEANER HOSE

## 15. REMOVE GENERATOR COVER

## 16. REMOVE BELT GENERATOR COVER

## 17. REMOVE ENGINE OIL LEVEL DIPSTICK GUIDE

## 18. REMOVE FAN AND GENERATOR V BELT

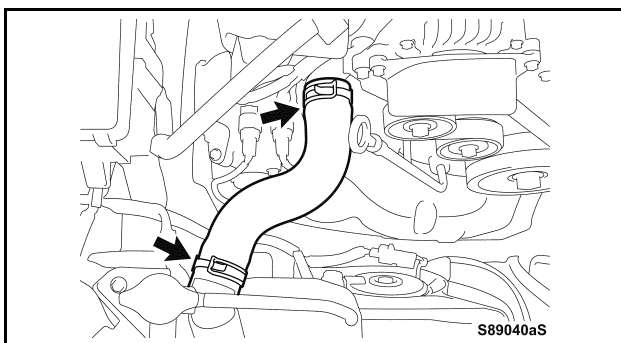

## 19. REMOVE RADIATOR INLET HOSE



The radiator inlet hose will be reused. **NEVER** use a tool such as a screwdriver to pry between the hose and pipe, or coolant leaks may occur.

## 20. DISCONNECT NO. 1 COOLER REFRIGERANT DISCHARGE HOSE (for Models with Air Conditioning System)

- a) Wear protective glasses.



Oil may fly out due to the effect of residual gases.

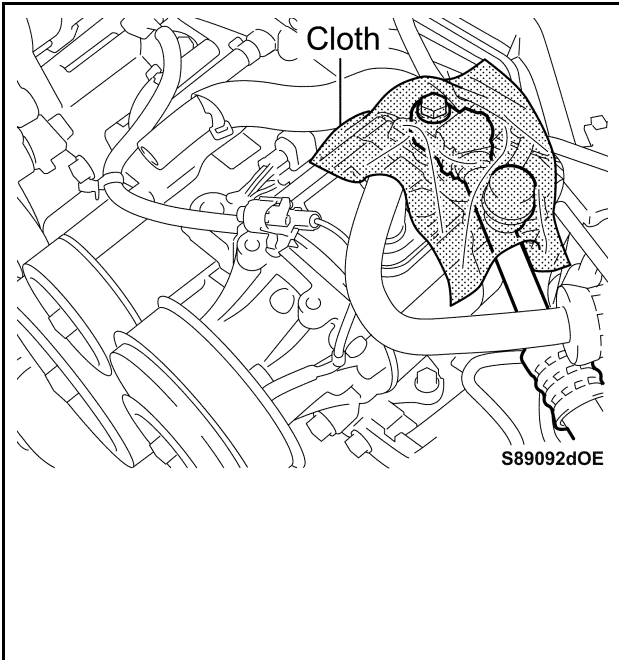

- b) Remove the bolt, and with a cloth covering it, slowly disconnect the discharge hose.



**Oil may fly out due to the effect of residual gases.**

- c) Remove the O-ring from the No. 1 cooler refrigerant discharge hose.
- d) Destroy the removed O-ring, and then store it in a separate container so as not to reinstall it in error.
- e) Attach protective tape to the disconnected hose and compressor fittings to prevent foreign matter, fluids, etc., from contaminating.



**DO NOT** twist the hose

**21. REMOVE COMPRESSOR WITH MAGNET CLUTCH ASSEMBLY (for Models with Air Conditioning System)**

- a) Move the compressor and fasten it with a piece of rope to where it will not interfere with the next steps.



- **DO NOT** apply excessive force on the suction hose.
- Be sure to have the compressor held by a piece of rope as shown. If not, it will easily fall when pushed by hand, tool, etc.

**22. REMOVE GENERATOR ASSEMBLY**

**23. REMOVE THROTTLE WITH MOTOR BODY ASSEMBLY**

**24. DISCONNECT ENGINE WIRE**

**25. DISCONNECT VACUUM TUBE CONNECTOR HOSE**

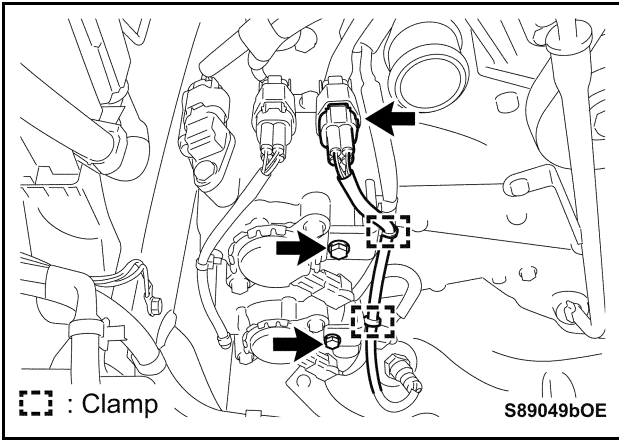

## 26. SEPARATE AIR FUEL RATIO SENSOR

- a) Remove the 2 bolts.
- b) Disengage the 2 clamps by pressing in the claws one side at a time on each with a flathead screwdriver, and separate the wire harness.
- c) Disconnect the connector.

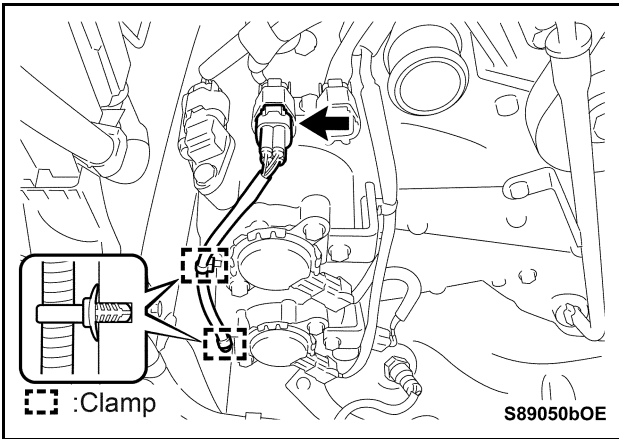

## 27. SEPARATE OXYGEN SENSOR

- a) Disconnect the connector.
- b) Pull the 2 clips out straight and separate the oxygen sensor.

**28. REMOVE FRONT TIRES**

**29. REMOVE No 1 ENGINE UNDER COVER**

**30. REMOVE NO. 2 ENGINE UNDER COVER**

**31. REMOVE REAR ENGINE UNDER COVER LH AND RH (w/ Floor Under Cover)**

## 32. DISCONNECT EXHAUST MANIFOLD



- **DO NOT** remove the fastening bolt for the manifold and pipes as the exhaust manifold is to remain on the vehicle.
- **DO NOT** use rope materials that are easy to melt due to heat.

- Insert cloths to prevent interference with the center member for when the fixing nuts are removed from the exhaust pipe and the parts are lowered.
- Pass the rope through the radiator support lower to support the exhaust manifold as shown below, for when the nuts are removed.

**NOTE:**

Exhaust manifold weight: Approximately 7.5 kg

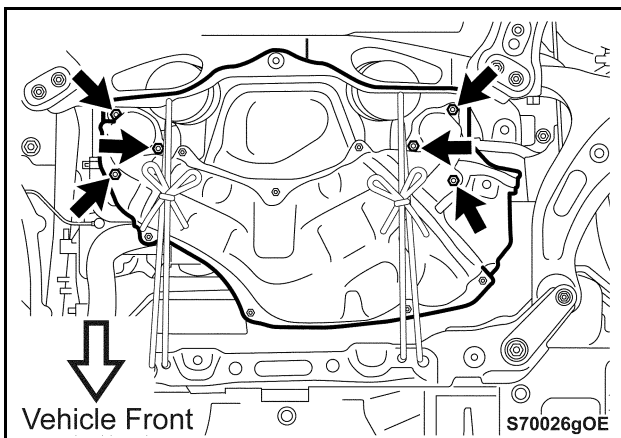
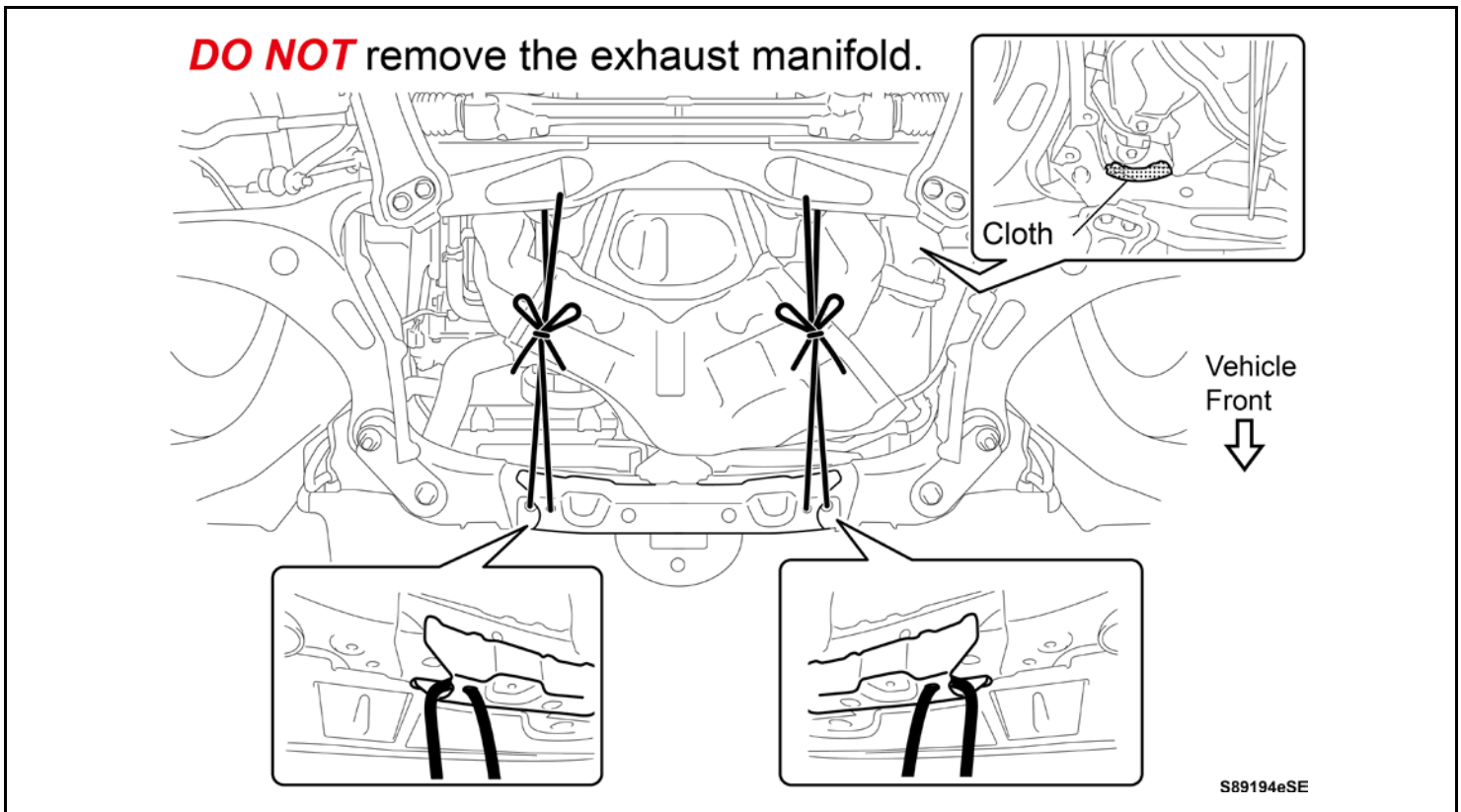

- Remove the 6 nuts and separate the exhaust manifold from the engine.
- Mark and store the removed 6 bolts in a separate container so as not to reinstall them in error.

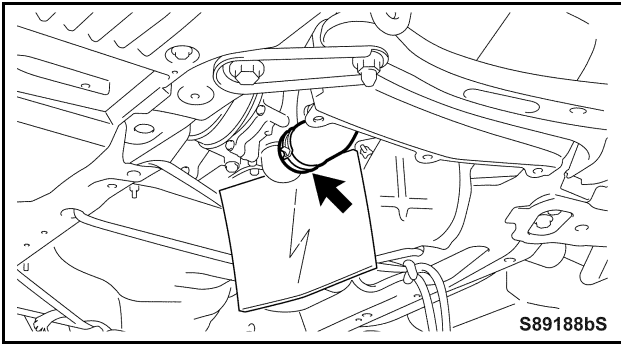

**33. DISCONNECT RADIATOR OUTLET HOSE**

- a) Protect the manifold with a cloth to prevent coolant from getting in the exhaust manifold.
- b) Disconnect the radiator outlet hose.

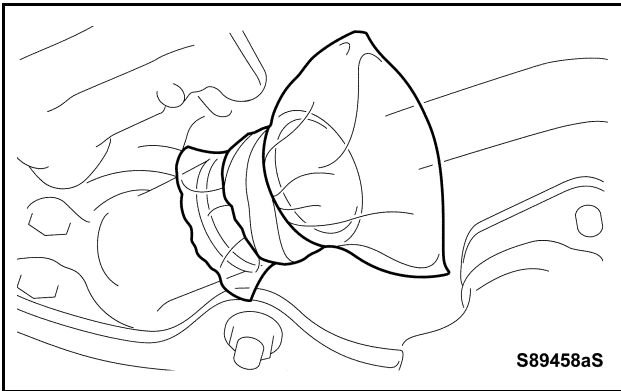

- c) Protect the disconnected water outlet by covering the opening with a plastic bag as shown.

**STOP** Be sure to protect the water outlet as oil may enter the outlet when disassembling the engine.

**34. DISCONNECT GROUNDED CABLE**

**35. REMOVE FRONT STABILIZER LINK ASSEMBLIES RH AND LH (for Automatic Transmission)**

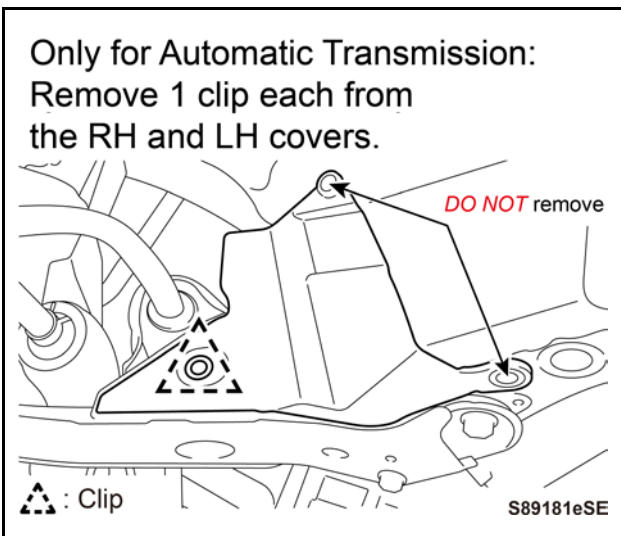

**36. REMOVE FRONT STABILIZER BARS RH AND LH (for Automatic Transmission)**

- a) Remove only 1 clip, each from the left and right engine under covers.

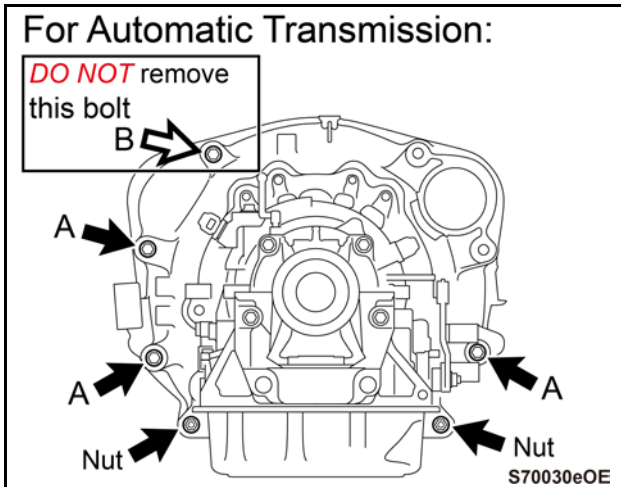

### 37. REMOVE AUTOMATIC TRANSMISSION ASSEMBLY COUPLING BOLTS AND NUTS (for Automatic Transmission)

- a) Remove the 3 A bolts and the 2 nuts.



- Remove the engine and the transmission coupling bolts and nuts in this step and complete the work on the underside.
- **DO NOT** remove the B bolt in this step, or unnecessary gaps between the engine and transmission may be formed during work.

- b) Remove the 2 lower studs

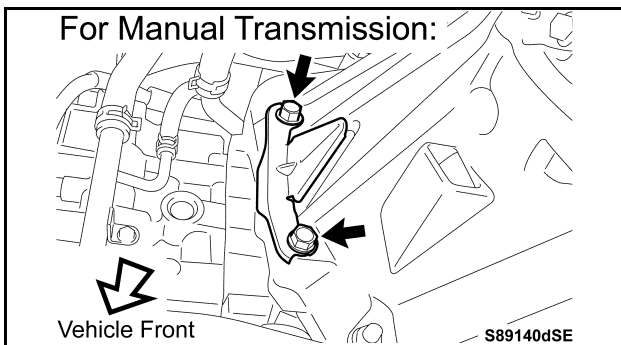

### 38. REMOVE MANUAL TRANSMISSION ASSEMBLY COUPLING BOLTS AND NUTS (for Manual Transmission)

- a) Remove the 2 bolts and the clutch housing cover.

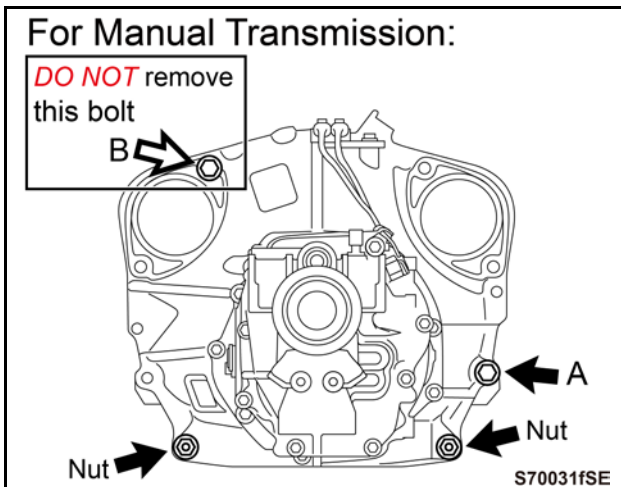

- b) Remove the A bolt and the 2 nuts.



- Remove the engine and the transmission coupling bolts and nuts in this step and complete the work on the underside.
- **DO NOT** remove the B bolt in this step, or unnecessary gaps between the engine and transmission may be formed during work.

- c) Remove the 2 lower studs

### 39. DISCONNECT TRANSMISSION OIL COOLER HOSE (for Automatic Transmission)

### 40. DISCONNECT HEATER WATER HOSES (for Manual Transmission)