

September 28, 2018

Version 1

## Safety Recall: Front Passenger's Airbag Inflator Can Be Over-Pressurized (Phase 4)

Following NHTSA direction, there are five phases based on three different zones.

If the iN VIN status inquiry directs you to do this campaign, follow the applicable procedure regardless of where the vehicle is currently located because it may have moved between different states. Make sure you file a claim using the correct warranty claim information to avoid your claim being rejected.

### AFFECTED VEHICLES

#### Zone A

There are no affected vehicles in Zone A.

#### Zone B

Year	Model	Trim	VIN Range
2011-12	RL	ALL	Check the iN VIN status for eligibility.

Zone B applies to model years 2011 through 2012 vehicles, that are located or ever registered in: Arizona, Arkansas, Delaware, District of Columbia, Illinois, Indiana, Kansas, Kentucky, Maryland, Missouri, Nebraska, Nevada, New Jersey, New Mexico, North Carolina, Ohio, Oklahoma, Pennsylvania, Tennessee, Virginia, and West Virginia.

#### Zone C

Year	Model	Trim	VIN Range
2010-12	RL	ALL	Check the iN VIN status for eligibility.

Zone C applies to model years 2010 through 2012 vehicles, that are located: Alaska, Colorado, Connecticut, Idaho, Iowa, Maine, Massachusetts, Michigan, Minnesota, Montana, New Hampshire, New York, North Dakota, Oregon, Rhode Island, South Dakota, Utah, Vermont, Washington, Wisconsin, and Wyoming.

### BACKGROUND

NHTSA and its independent expert reviewed the findings of three independent investigations into the Takata air bag inflator ruptures. According to NHTSA, the combination of time, high temperature fluctuations, and humidity contribute to the degradation of the propellant in the inflators. NHTSA has concluded that this degradation can cause the propellant to burn too quickly, creating more pressure than the inflator can withstand, and, in extreme cases, causing the inflator to rupture and send shrapnel through the airbag toward vehicle occupants. NHTSA is prioritizing the recall of airbag inflators based on the risk of injury or death to vehicle occupants.

Currently there are five planned phases to this campaign. The final phase will launch in about a year per NHTSA direction. Additionally, AHM may add new affected models or affected years to each phase. Always do an iN VIN status inquiry to see if a vehicle is affected.

**CLIENT INFORMATION:** The information in this bulletin is intended for use only by skilled technicians who have the proper tools, equipment, and training to correctly and safely maintain your vehicle. These procedures should not be attempted by "do-it-yourselfers," and you should not assume this bulletin applies to your vehicle, or that your vehicle has the condition described. To determine whether this information applies, contact an authorized Acura automobile dealer.

For more information about these inflator recalls, go to [www.safercar.gov](http://www.safercar.gov) and use keyword TAKATA.

**NOTE**

**If the VIN status inquiry indicates that the vehicle is subject to any open safety recalls, including the driver's airbag inflator, make sure to also complete those recall repairs before returning the vehicle to the client. If you are unable to complete any open recall, advise the client of the recall status and when the recall could be completed.**

Make sure you review this service bulletin for installation instructions and details about model applicability.

**CLIENT NOTIFICATION**

Owners of affected vehicles will be sent a notification of this campaign.

Do an iN VIN status inquiry to make sure the vehicle is shown as eligible.

Some vehicles affected by this campaign may be in your used vehicle inventory.

Failure to repair a vehicle subject to a recall or campaign may subject your dealership to claims or lawsuits from the client or anyone else harmed as a result of such failure. To see if a vehicle in inventory is affected by this safety recall, do a VIN status inquiry before selling it.

**CORRECTIVE ACTION**

Replace the passenger's airbag inflator, then return the original, undeployed inflator as directed.

**PARTS INFORMATION**

Part Name	Order Part Number	You may receive any of the following	Quantity
2010–12 RL Front Passenger's Airbag Inflator Kit	04790-SJA-315	04790-SJA-315 04790-SJA-305	1

**NOTES**

- Replacement inflators with P/Ns that end with 305 come with shipping insulation wrapped around them. Follow the removal instructions listed in REPAIR PROCEDURE. The insulation is not toxic but some people may be sensitive to it.
- Replacement part numbers ending in 315 are similar to the ones with plastic caps at the end but the plastic caps have square openings.
- The inflator kit box must be used to return the recalled inflator to its supplier. Be careful not to damage the inflator kit box.
- If the recalled, undeployed inflator is not returned, the warranty claim for that vehicle will be charged back to your dealership.
- To return the undeployed inflators, follow the shipping instructions outlined in PIB B15-0006.
- Parts staff can scan the part number and serial number from the outside of the box into the warranty claim by using the Controlled Part Serial No. screen and scanning the applicable information. Refer to the Job Aid **Ordering and Managing Replacement Inflators** for more information.
- Replacement inflators with P/Ns that end with 305 come with shipping insulation wrapped around them. Follow the removal instructions listed in REPAIR PROCEDURE. The insulation is not toxic but some people may be sensitive to it.
- Replacement part numbers ending in 315 are similar to the ones with plastic caps at the end but the plastic caps have square openings.

## WARRANTY CLAIM INFORMATION

### NOTES

- Process claims as quickly as possible so that resources can be properly allocated.
- Enter the part number of the inflator that you received into the warranty claim, **not the part number that you ordered**. For more information, refer to step 6 of REPAIR PROCEDURE.
- To avoid non-payment of warranty claims, the serial number of the new airbag inflator must be entered in the warranty claim. For more information, refer to step 6 of REPAIR PROCEDURE.
- To avoid a warranty claim being charged back to your dealership, you must return the original, undeployed inflator to its supplier. Follow the shipping instructions outlined in PIB B15-0006, Inflator Kit Return Process.
- The serial number is encoded into the bar code printed on the label inside of the box and on a label attached to the outside of the box. If your dealership uses a scanner, you can scan the serial number from either place into the claim.
- The part number is encoded into a barcode attached to the outside of the box. If your dealership uses a scanner, you can scan the part number into the claim.
- If you confuse the serial number and part number when entering the claim information, your claim will automatically be rejected.
- For more information about scanning and filing airbag inflator recall claims, refer to **Ordering and Managing Replacement Inflators**. From the iN, select **Service, Warranty**, then **Claims Reference Guide**. Under **HOT TIPS/ TOPICS**, select **Ordering and Managing Replacement Inflators**.
- Each VIN is assigned to a specific campaign. Make sure you file a claim using the correct warranty claim information to avoid your claim being rejected.

### Replacing the front passenger's airbag inflator

Year/Model	Operation Number	Replacement Part Number	Flat Rate Time	Defect Code	Symptom Code	Template ID	Failed Part Number
2010–12 RL	7541F6	04790-SJA-305	0.8 hr	6DD00	S2I00	B18055A	06780-SJA-A80
		04790-SJA-315	0.8 hr	6DD00	S2I00	B18055B	06780-SJA-A80

Skill Level: Repair Technician

## IDENTIFYING COUNTERFEIT AIRBAGS

This section goes over the steps to identify counterfeit airbags and applies to all vehicles in this service bulletin. It is referred to in each vehicle's repair procedure. Click [HERE](#) to watch a video to help identify counterfeit airbags.

- If there is nothing unusual about the airbag or the inflator, continue with the inflator replacement procedure.
- If there are any unusual markings, like an incorrect label or a model year written in marker, the airbag and inflator may not be the correct airbag and/or inflator for the vehicle or it may be a counterfeit part. For more information about counterfeit airbags, you can refer to [safercar.gov](http://safercar.gov), enter keywords **MANAGING COUNTERFEIT**, and select **Recommended Dealer Guidance for Managing Counterfeit Air Bags** from the list. **If you suspect that the airbag or inflator is counterfeit, do not continue this procedure.** Contact your DPSM for assistance

NON-STANDARD SAFETY LABEL

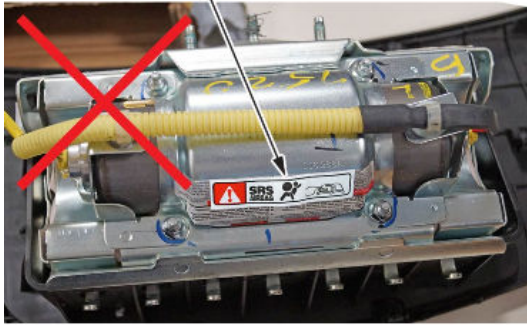

GREASE PENCIL OR PAINT MARKINGS

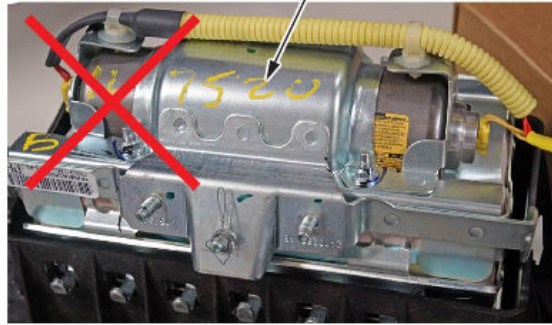

HAND ENGRAVING



NO LABELS ON INFLATOR

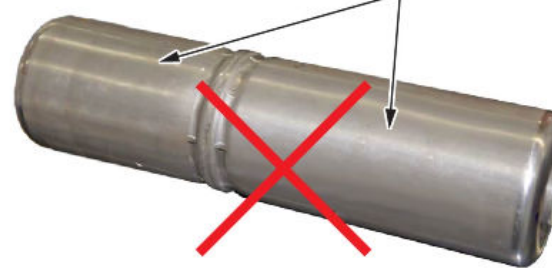

## REPAIR PROCEDURE RL

### NOTES

- **If the VIN status inquiry indicates that the vehicle is subject to any open safety recalls, including the driver's airbag inflator, make sure to also complete those recall repairs before returning the vehicle to the client. If you are unable to complete any open recall, advise the client of the recall status and when the recall could be completed.**
  - Make sure you have the anti-theft code for the audio and navigation system (if applicable), then write down the frequencies for the radio's preset buttons.
  - Be careful not to damage any parts when replacing the inflator, and **follow the procedure exactly.**
  - If, before removing the airbag, you suspect that it may be the incorrect airbag for the vehicle or a counterfeit, **do not remove the airbag.** Contact your DPSM for assistance.
  - Make sure you have reviewed the SRS Precautions and Procedures in the service information before doing the REPAIR PROCEDURE.
1. Turn the ignition switch to the ON (II) position and check if the SRS indicator comes on for about 6 seconds, then turns off.
    - If the indicator comes on, then turns off after about 6 seconds, go to step 2.
    - If the indicator does not come on, or if it stays on, contact your DPSM for assistance.

2. Disconnect the battery negative cable and wait at least 3 minutes before continuing.
3. Remove the front passenger's airbag. Refer to the applicable vehicle's service information.
4. Place the airbag, face-down, on a clean shop towel.

**NOTE**

The orientation of the airbag is critical because if the inflator is installed incorrectly, the harness will be too short when you reinstall the airbag.

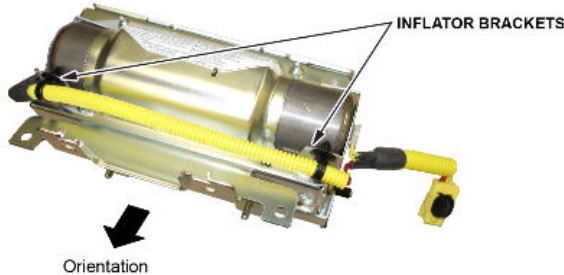

5. Visually inspect the airbag and the inflator for any unusual writing or markings. Refer to IDENTIFYING COUNTERFEIT AIRBAGS.
6. Peel the label located inside the inflator box from its backing and attach it to the RO. For the warranty claim to be paid, the **replacement inflator part number that you received** must be included in the warranty claim.

**NOTES**

- The replacement part number is printed on the top part of the label and the serial number is printed on the bottom. **Make sure you attach the label to the RO and give it to the warranty clerk .**
- There may also be a colored sticker located in the kit, ignore it because it is not used.
- Not all inflator kits have a label included. In those cases, write the serial number and part number from the side of the inflator box on the RO. The part number always starts with 047.

**PASSENGER INFLATOR PARTS BOX**

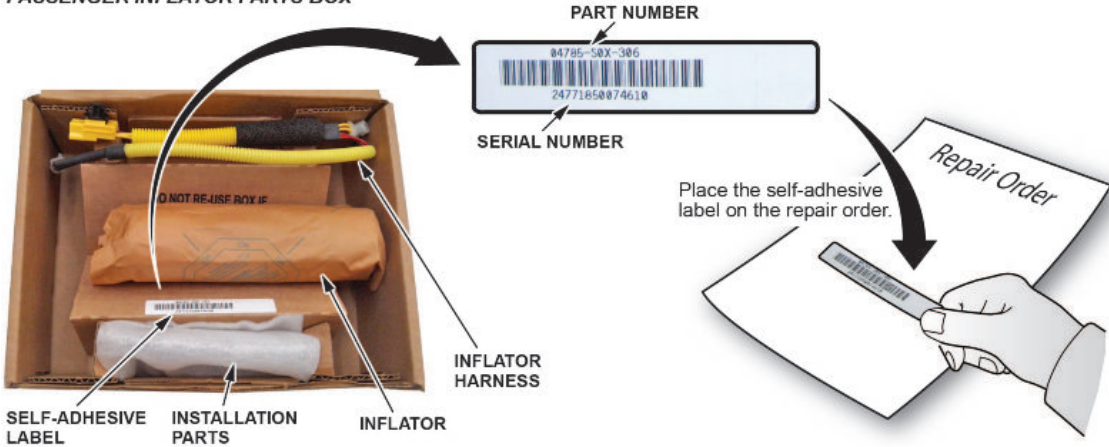

7. Remove the harness from both ends of the inflator bracket.

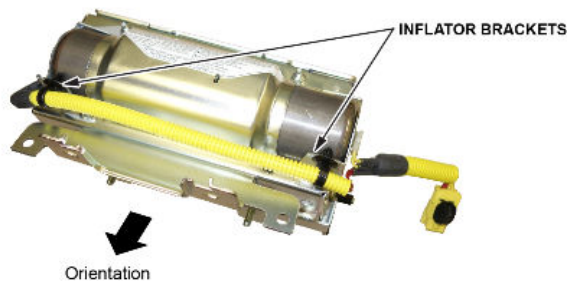

8. Short the yellow wires.

**NOTE**

**You must cut and short the wires** as indicated to prevent accidental deployment.

- 8.1. Cut the black rubber tubing to separate the red and yellow wires.

**NOTE**

Make sure you don't cut the wires at this stage.



8.2. Cut and remove the yellow corrugated tubing.



YELLOW WIRES

8.3. Cut the yellow wires as shown.

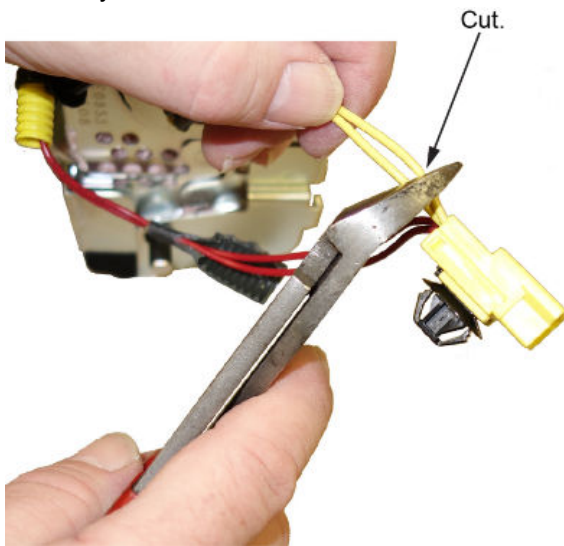

8.4. Strip away about 1 inch of the wire insulation, then twist the wires together.

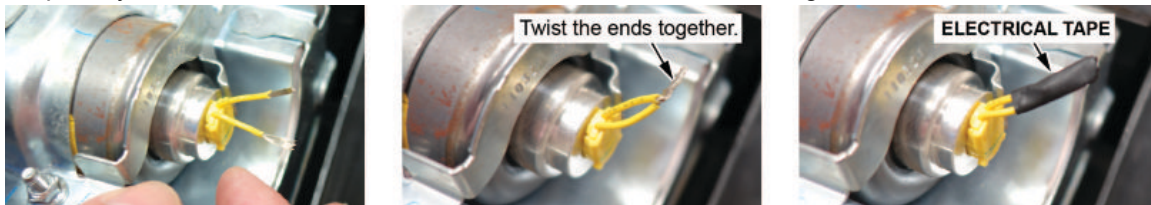

8.5. Tape the twisted ends with electrical tape.

9. Remove the four inflator nuts.

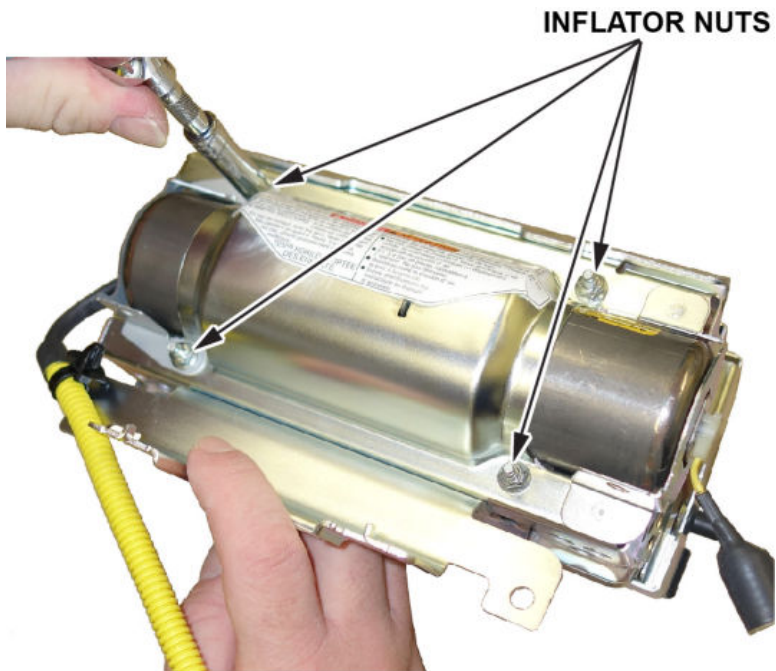

10. Remove the inflator bracket.

**NOTE**

You can only remove one of the brackets, as the other is welded to the airbag housing.

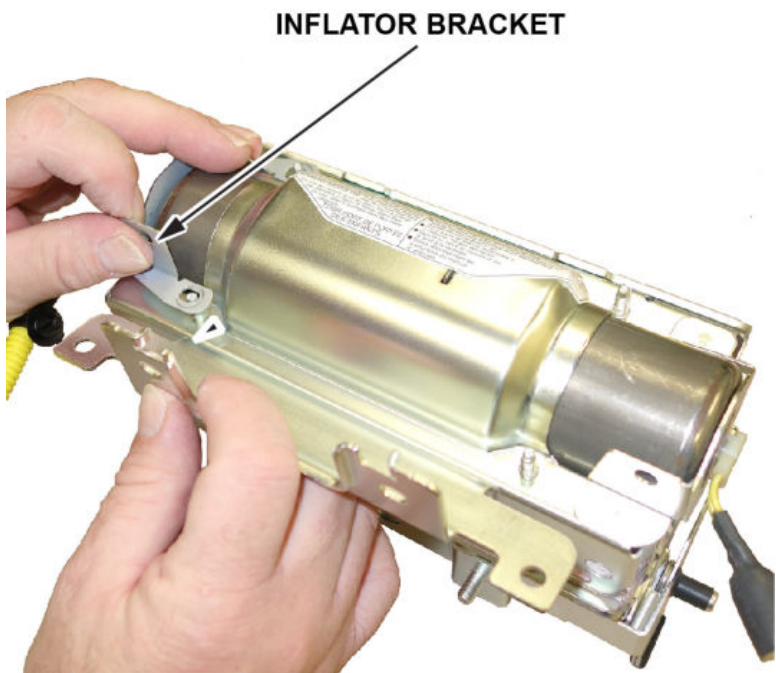



11. Remove the inflator by pushing/pulling it out.



12. Install the new inflator.

**NOTE**

There may be some minor surface rust or corrosion on the new inflator; this is OK.

Click [HERE](#) for a short video about the different variations of the driver's and front passenger's replacement inflators involved with the recalls related to inflators. While both the driver's and front passenger's inflators are shown in the video, this is informational only. Replace inflators only as directed by the iN VIN status inquiry.

12.1. **Make sure you have the correct part number for the vehicle you're working on.**

**NOTE**

If the inflator is wrapped in an insulated sleeve, go to [INSULATION REMOVAL](#) for instructions to remove it.

**Part Number**

04790-SJA-305

04790-SJA-315

12.2. Collars on this inflator are orange. One side of the inflator has a longer collar, a tab, a plastic cutout, and a small flat spot on the connector. The other side of the inflator has a shorter collar, two tabs, and a red dot. **Make sure you insert the end with the longer collar into the airbag first.**

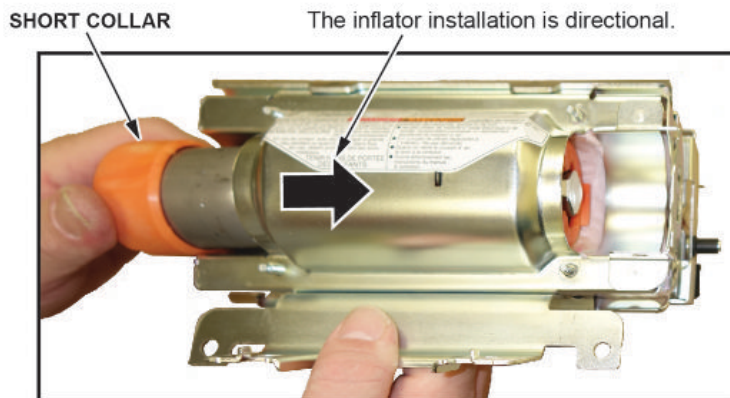
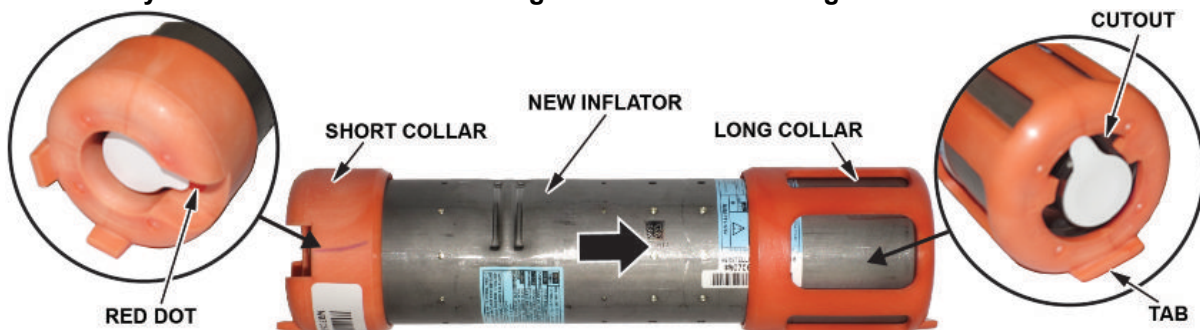

12.3. Slide the inflator in until the plastic cutout and the small flat spot align with the tab on the bracket. There should be no space or gap between the inflator and bracket.

**FIXED BRACKET END**

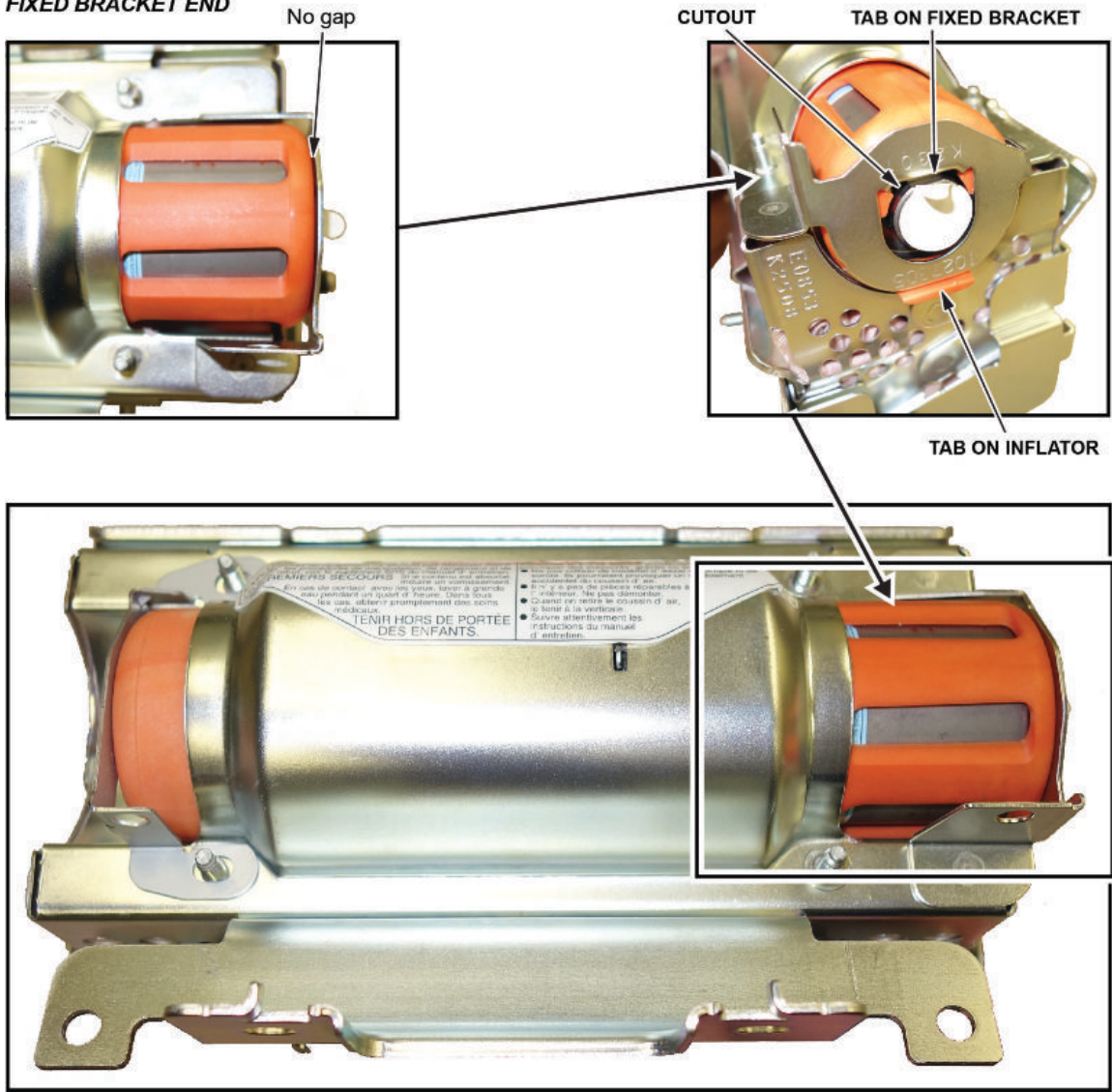

12.4. Install the bracket included in the kit onto the airbag module. There should be a red dot visible on the end of the plastic collar. There should be no space or gap between the inflator and bracket.

**ADJUSTABLE  
BRACKET END**

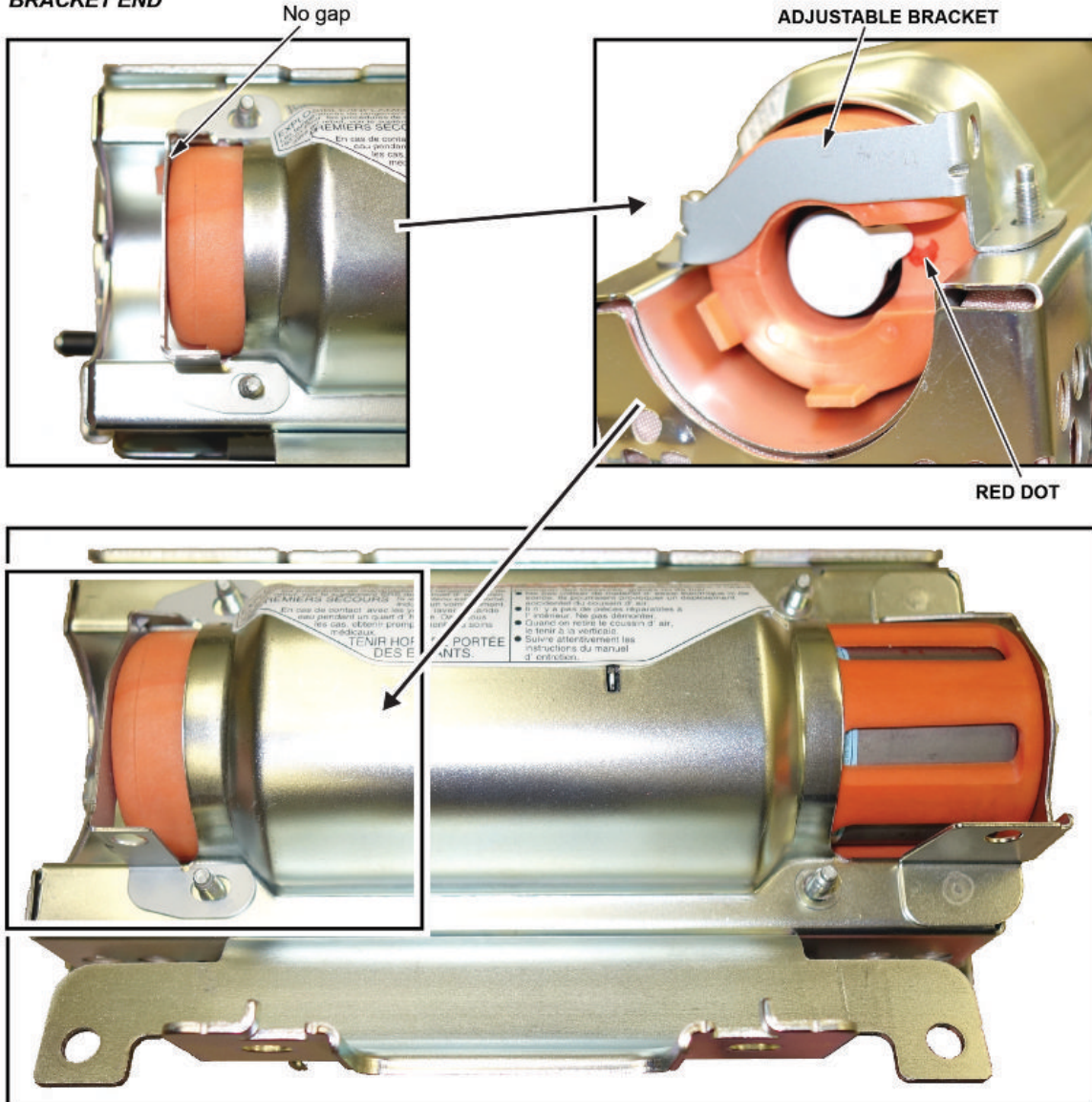

13. Install the four new 5 mm locknuts and torque them in sequence to **3.9 N•m (34 lb-in)** .

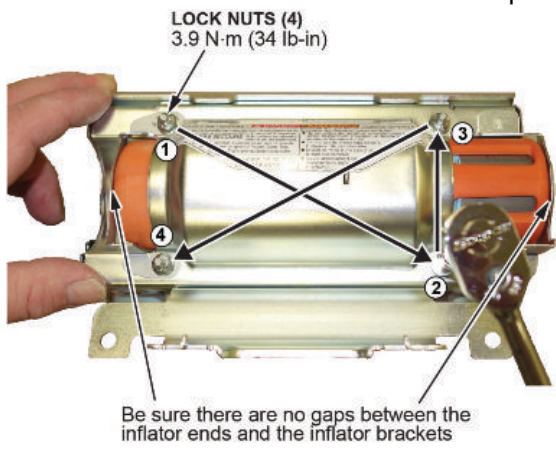

14. Remove the stickers covering the terminals on both sides of the new inflator.

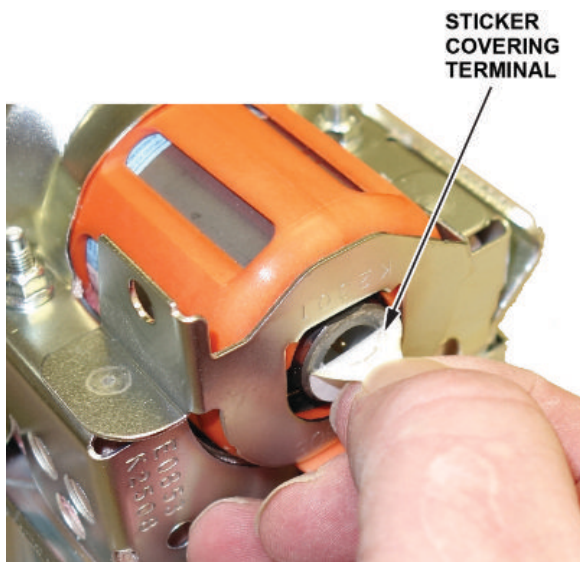
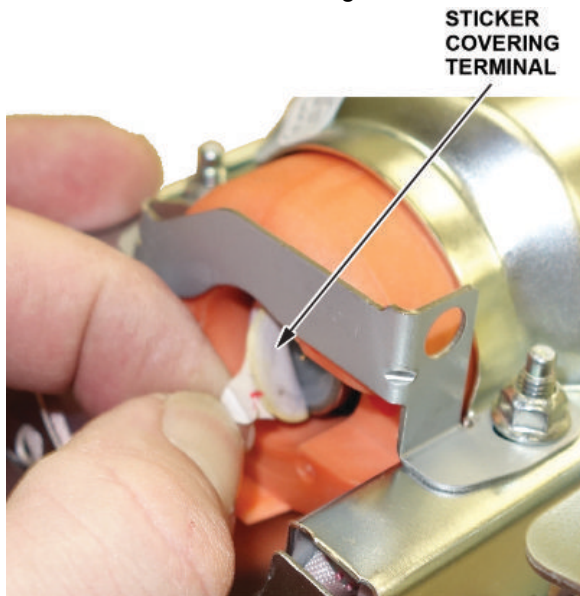

15. Install the new inflator harness.

15.1. Make sure the airbag and harness are aligned as shown.

**NOTES**

- **Make sure you have the orientation correct as shown below.** If you connect the harness incorrectly, the harness cannot be removed, and you will not be able to reinstall the airbag because the harness will be too short.
- Connect the red wire connector to the short collar side of the inflator with the red dot.

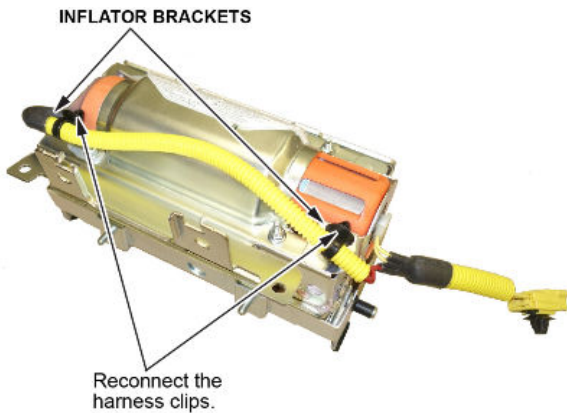

15.2. Connect the two connectors. Align the "T" shape in the inflator harness connector with the T-shaped inflator connector, then press the connector into place.

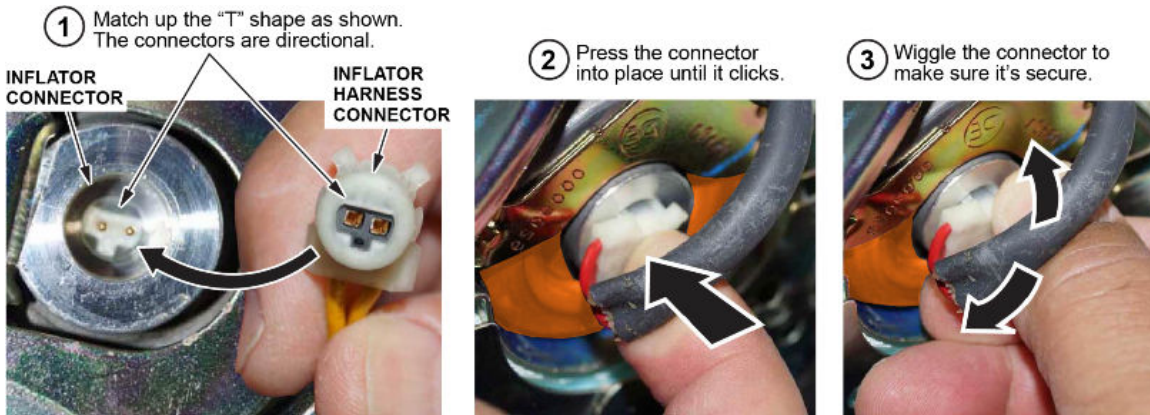

15.3. After you hear each connector click, wiggle it to make sure it is secure.

**NOTE**

If the connector is not properly aligned, it will come out.

16. Connect the harness to the inflator brackets.

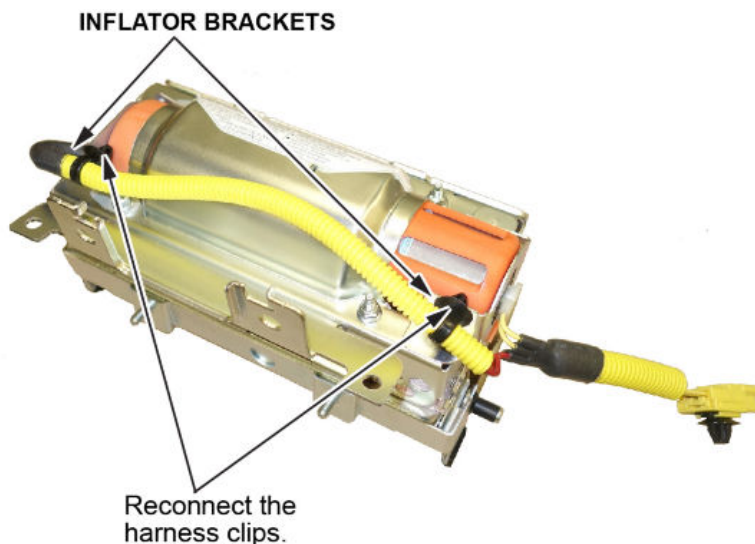

17. Reinstall the passenger's airbag into the vehicle and torque the new locknuts to **9.8 N•m (7.2 lb-ft)** .
18. Reconnect the battery negative cable and enter the anti-theft code for the audio and navigation system (if applicable), then enter the audio presets.
19. Set the clock (for vehicles without navigation).
20. Turn the ignition to ON and make sure the SRS indicator comes on for about 6 seconds, then goes off.
21. Put the original inflator into the box the new one came in. Make sure there is no other hardware in the box because if the package rattles, it will not be accepted by the courier.

**NOTE**

If the new inflator came with an insulated sleeve, make sure you change the orientation of the cardboard insert so that the original inflator doesn't rattle. See INSULATION REMOVAL for more information.

22. Follow the shipping instructions outlined in PIB B15-0006 to return the undeployed inflator.
23. Give your warranty clerk the RO that includes the replacement inflator serial number and replacement part number. For the warranty claim to be paid, the **replacement inflator part number** must be included in the warranty claim.

## INSULATION REMOVAL

If the replacement inflator is wrapped with shipping insulation, remove it.

### NOTES

- Wear disposable gloves and protective glasses. The insulation is not toxic or dangerous, but some people may be sensitive to the insulation.
  - Dispose of the insulation and wrapping paper to avoid getting the insulation dust/fibers on you or the airbag assembly.
  - Do not reuse the insulation or wrapping paper. You do not need to wrap the inflator being removed from the vehicle when it is returned.
1. Cut the wires off from the opposite side from where they are tied (twisted) together.

### NOTE

Do not cut the insulation.



2. Hold the paper wrapping the inflator with one hand and slide the insulation off into the trash.

### NOTE

The insulation is securely wrapped around the inflator. You may have to use some force to slide the insulation off. Do not cut the insulation and be careful that you do not move the white or orange plastic ends.





3. Remove the wrapping paper and drop it into the trash.



4. To return the original inflator, remove the cardboard insert and turn it 90 degrees. Then insert the cardboard into the slots as shown.

#### NOTES

- **Do not reuse the shipping insulation.**
- The cardboard insert needs to be adjusted to send back the original inflator otherwise the original inflator removed from the vehicle will rattle around and may be rejected by the courier.

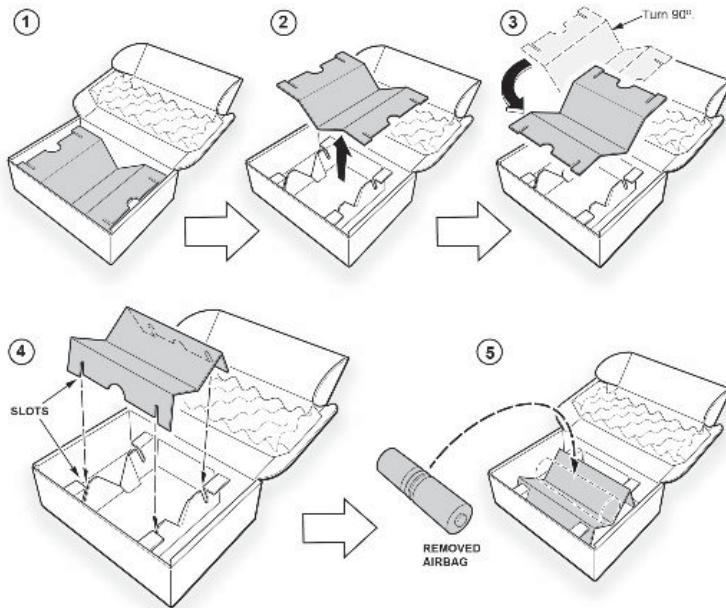

END