

**April 11, 2018**

Version 2

## Safety Recall: Front Seats Frame Rivets

Supersedes 18-042, dated April 6, 2018, to add PARTS INFORMATION, WARRANTY CLAIM INFORMATION, and REPAIR INFORMATION

### AFFECTED VEHICLES

Year	Model	Trim	VIN Range
2018	Ridgeline	RT-L, RTL-T, RTL-E, Black Edition	Check the iN VIN status for eligibility.
2018	Pilot	EX, EX-L, Touring, Elite	Check the iN VIN status for eligibility.

### BACKGROUND

A limited number of 2018 Pilot and a very limited number of 2018 Ridgeline vehicles potentially were manufactured with defective seat frame rivets in the front seats. If a vehicle with a defective rivet is involved in a crash, the seat may not operate as designed to protect the occupant, leading to an increased potential for injury or death.

### CUSTOMER NOTIFICATION

Owners of affected vehicles will be sent a notification of this campaign.

Do an iN VIN status inquiry to make sure the vehicle is shown as eligible.

Some vehicles affected by this campaign may be in your new or used vehicle inventory.

Failure to repair a vehicle subject to a recall or campaign may subject your dealership to claims or lawsuits from the customer or anyone else harmed as a result of such failure. To see if a vehicle in inventory is affected by this safety recall, do a VIN status inquiry before selling it.

### CORRECTIVE ACTION

- Ridgeline (RT-L, RTL-T, RTL-E, Black Edition) - Replace **both** driver's and passenger's seat H-frames.
- Pilot (EX-L, Touring, Elite) - Replace **both** driver's and passenger's seat H-frames.
- Pilot (EX) - Replace **only** the driver's seat H-frame.

### PARTS INFORMATION

Part Name	Part Number	Quantity
Driver Seat Frame - Pilot (Touring or Elite)	81605-TG7-306	1
Driver Seat Frame - Pilot (EX or EX-L)	81605-TG7-305	1

**CUSTOMER INFORMATION:** The information in this bulletin is intended for use only by skilled technicians who have the proper tools, equipment, and training to correctly and safely maintain your vehicle. These procedures should not be attempted by "do-it-yourselfers," and you should not assume this bulletin applies to your vehicle, or that your vehicle has the condition described. To determine whether this information applies, contact an authorized Honda automobile dealer.

Part Name	Part Number	Quantity
Passenger Seat Frame - Pilot (EX-L, Touring or Elite)	81205-TG7-A32	1
Driver Seat Frame - Ridgeline (RTL-E or Black)	81605-TG7-306	1
Driver Seat Frame - Ridgeline (RTL or RTL-T)	81605-TG7-305	1
Passenger Seat Frame - Ridgeline (RTL, RTL-T, RTL-E or Black)	81205-T6Z-A41	1

#### WARRANTY CLAIM INFORMATION

Operation Number	Description	Flat Rate Time	Defect Code	Symptom Code	Template ID	Failed Part Number
8511L8	<b>Pilot EX-L</b> - Replace <b>driver's</b> seat frame	1.3 hrs	6JC00	T0T00	A18042A	81526-TG7-A11
8521J0	<b>Pilot EX-L</b> - Replace <b>passenger's</b> seat frame	1.3 hrs				
8511L8	<b>Pilot Touring/Elite</b> - Replace <b>driver's</b> seat frame (includes driving position memory clear procedure)	1.3 hrs	6JC00	T0T00	A18042B	81526-TG7-A11
8521J0	<b>Pilot Touring/Elite</b> - Replace <b>passenger's</b> seat frame	1.3 hrs				

Operation Number	Description	Flat Rate Time	Defect Code	Symptom Code	Template ID	Failed Part Number
8511L8	<b>Ridgeline RTL-E/Black</b> - Replace <b>driver's</b> seat frame (includes driving position memory clear procedure)	1.3 hrs	6JC00	T0T00	A18042C	81526-TG7-A11
8521J0	<b>Ridgeline RTL-E/Black</b> - Replace <b>passenger's</b> seat frame	1.3 hrs				
8511L8	<b>Ridgeline RTL/RTL-T</b> - Replace <b>driver's</b> seat frame	1.3 hrs	6JC00	T0T00	A18042D	81526-TG7-A11
8521J0	<b>Ridgeline RTL/RTL-T</b> - Replace <b>passenger's</b> seat frame	1.3 hrs				

Applies to driver's side only.

Operation Number	Description	Flat Rate Time	Defect Code	Symptom Code	Template ID	Failed Part Number
8511L8	Pilot EX- Replace driver's seat frame only.	1.3 hrs	6JC00	T0T00	A18042E	81526-TG7-A11

Skill Level: Repair Technician

## REPAIR PROCEDURE - REMOVING THE FRONT SEATS

### NOTES

- All power seats require replacement. A manual seat (Pilot EX front passenger seat) DOES NOT require replacement.
  - SRS Components are located in this area. Review the SRS component locations and the precautions and procedures in the service information before doing any repairs or service.
1. Remove the front seats. Refer to the service information.

### NOTES

- Set the seat to the highest position before removing the seat.
  - Do not remove the seat cushion cover and seat-back cover from their pads.
  - Do not disconnect the battery until the seat has been adjusted as needed to remove the seats from the vehicle.
  - Use special tool T/N: 007AAF-TG7A100 when removing the front passenger's seatbelt from the anchor.
2. Place the seat(s) on a level working surface.

For driver's seat repair information, go to REPAIR PROCEDURE - DRIVER'S SEAT.

For front passenger's seat repair information, go to REPAIR PROCEDURE - PASSENGER'S SEAT.

## REPAIR PROCEDURE - DRIVER'S SEAT

1. Remove the rear foot covers.



FRONT SEAT REAR FOOT COVERS

2. Remove the front cushion cover.

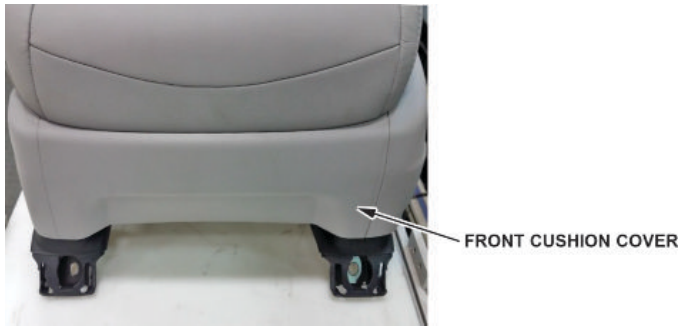

3. Remove the outer seat recline cover.



4. Remove the upper rail outer cover.



5. Remove the inner recline cover.



6. Disconnect the seat cushion blower bag. (Pilot Elite trim only)

**NOTE**

Leave the blower motor on the seat.

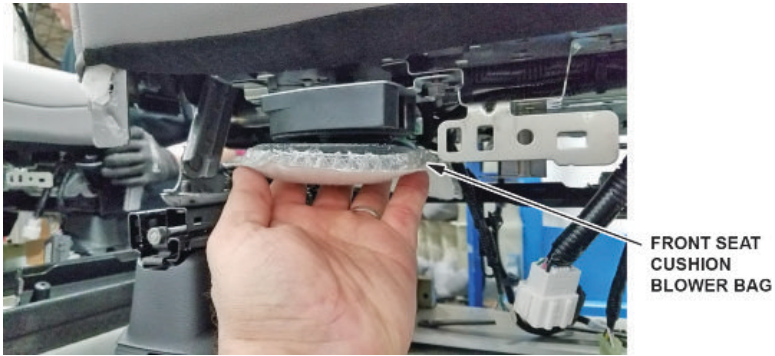

7. Remove the front foot covers.

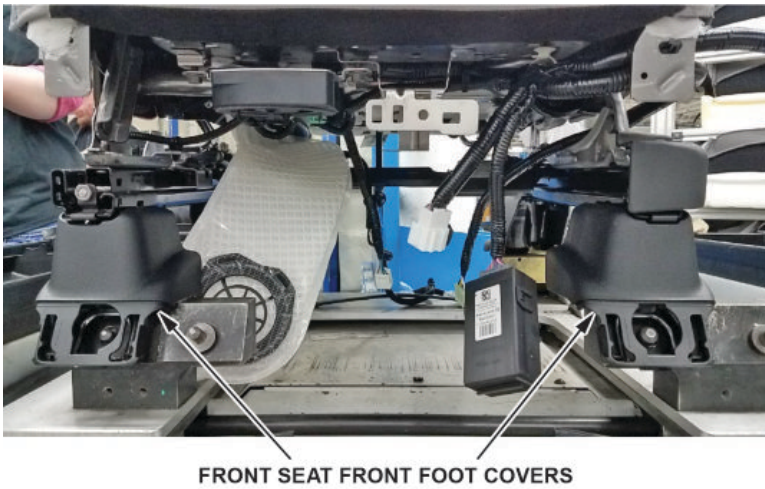

8. Disconnect the slide motor harness connector and harness clips.

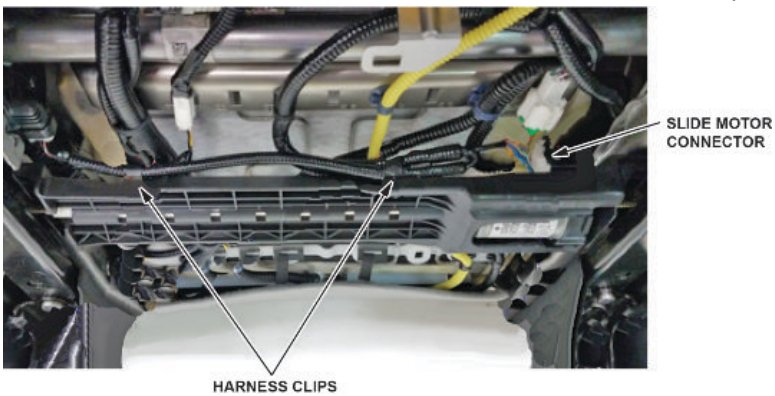

9. Remove 2 torx bolts at the rear-right corner of the driver seat.

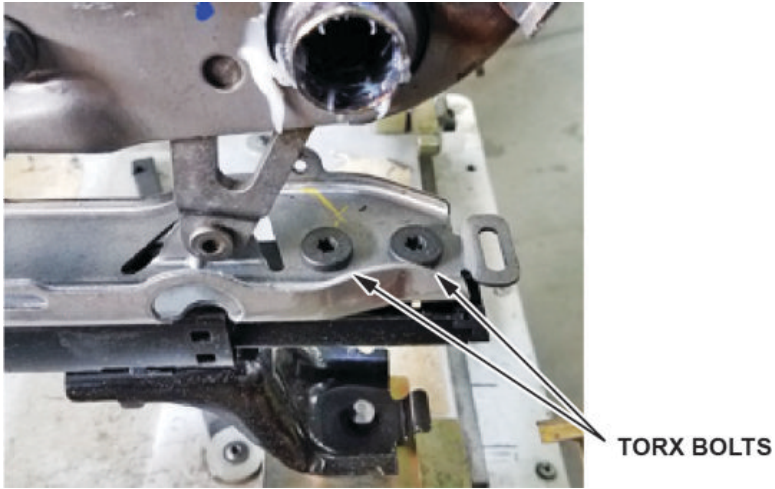

10. Remove 2 nuts at the remaining 3 corners.



11. Make sure nothing is connected to the frame, then slowly lift the seat and set it aside.

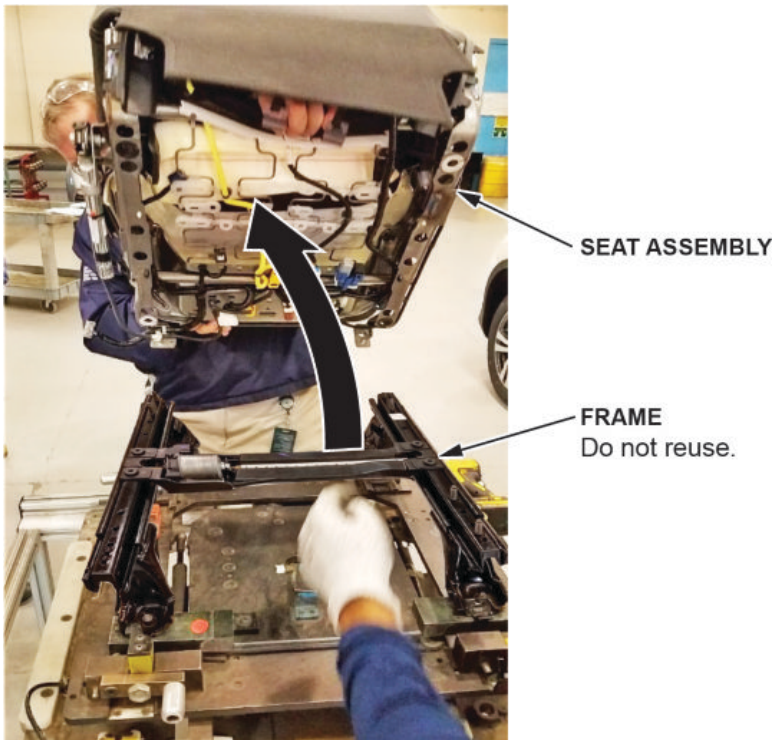

12. Make sure the new frame is for the driver's side, and replace it with the original driver's seat frame.

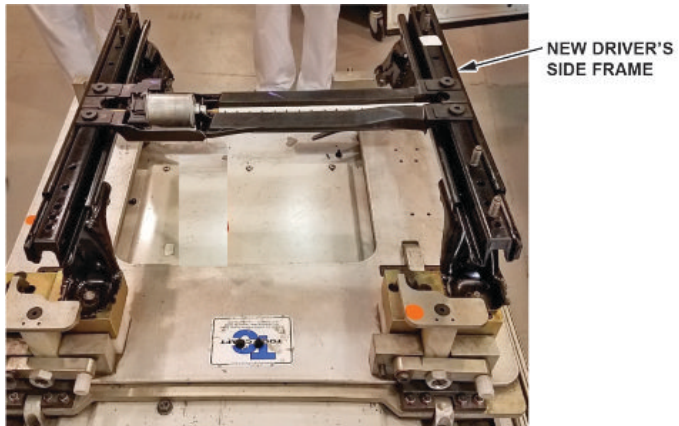

13. Slowly place the driver's seat onto the new frame.

**NOTE**

Make sure nothing gets pinched between the seat and frame.

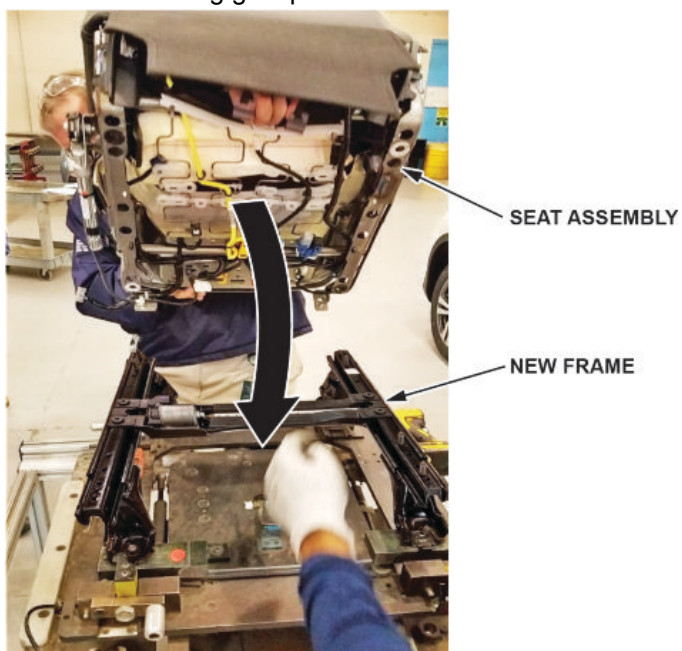

14. Install and hand tighten the 2 torx bolts into the rear-right corner, then the 2 nuts in the remaining 3 corners.



15. Torque the torx bolts and nuts to **30 N·m (22 lb-ft)** in the sequence shown.

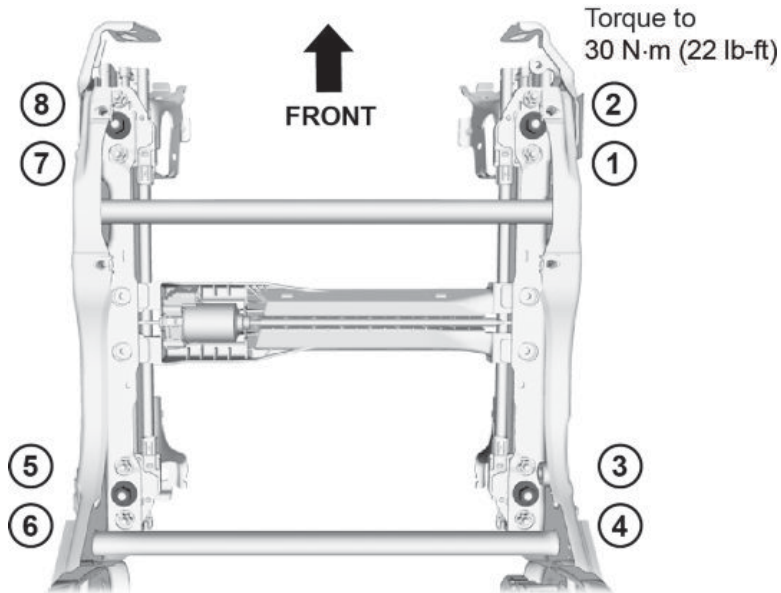

16. Install all removed parts on the driver's seat in the reverse order of removal.

17. Once you are finished with both driver's and front passenger's seat repair, go to REPAIR PROCEDURE - INSTALLING THE FRONT SEATS.

#### REPAIR PROCEDURE - FRONT PASSENGER'S SEAT

##### NOTE

All power seats require replacement. A manual seat (Pilot EX front passenger seat) DOES NOT require replacement.

1. Remove the rear foot covers.



FRONT SEAT REAR FOOT COVERS

2. Remove the front cushion cover.



FRONT CUSHION COVER



3. Remove the outer recline cover cap, then the outer seat recline cover.

**NOTE**

Carefully remove the recline cover cap to avoid damage.



4. Remove the inner recline cover.



5. Unclip the trim cushion hook strips and all the hook strips under the seat.

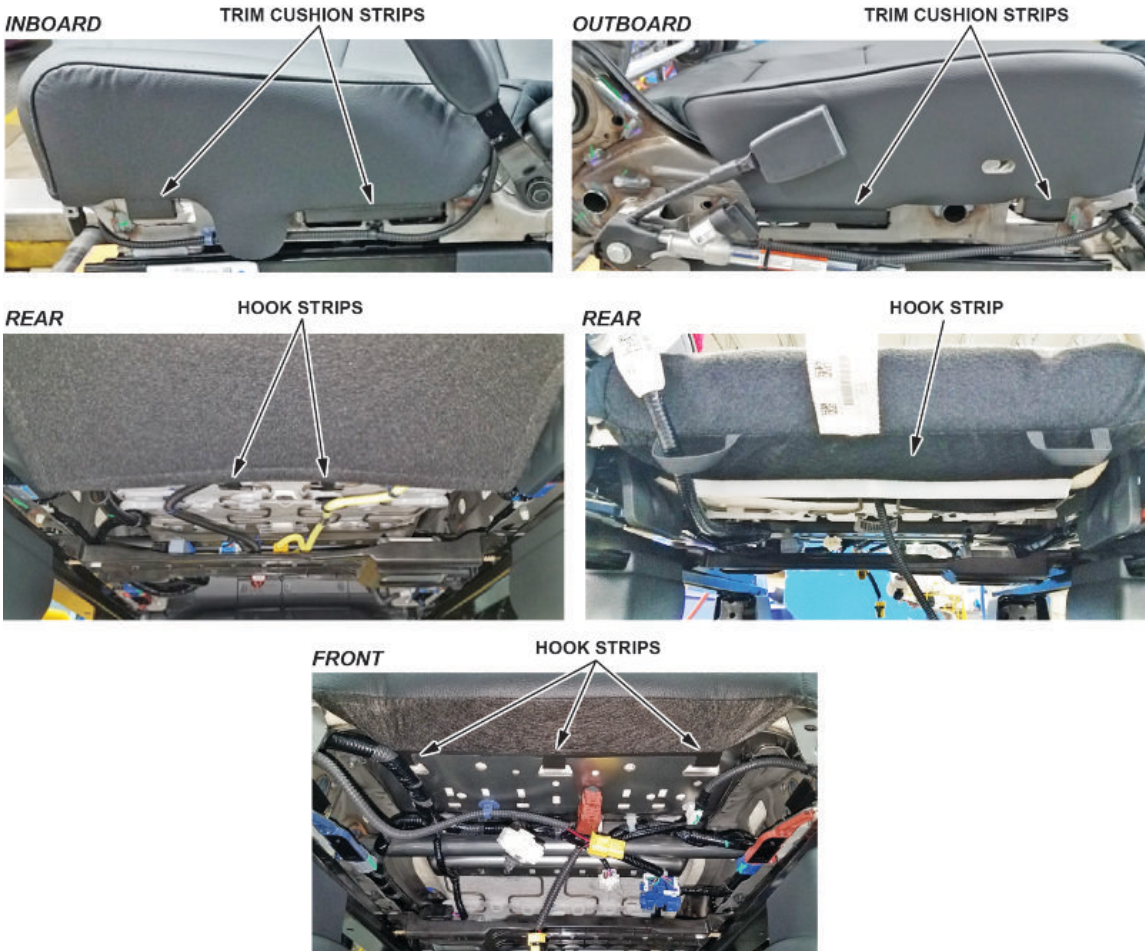

6. Disconnect the seat cushion blower bag. (Pilot Elite trim only)

**NOTE**

Leave the blower motor on the seat.



7. Remove the front foot covers.

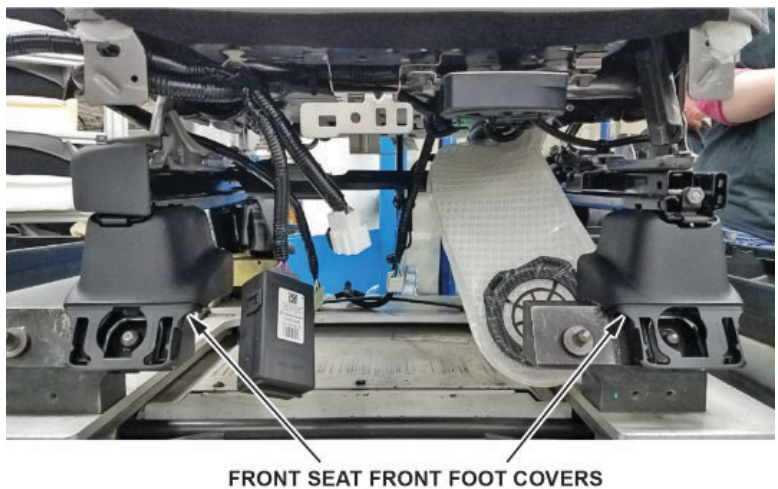

8. Disconnect the passenger's weight sensor connectors.



9. Disconnect the slide motor connector.

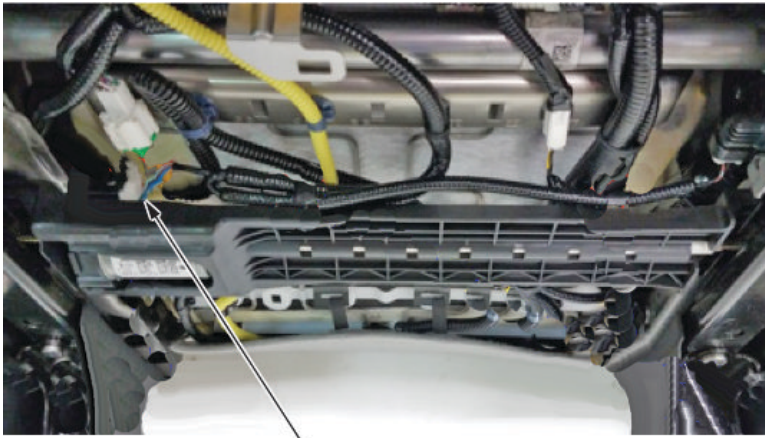

SLIDE MOTOR CONNECTOR

10. Remove the weight sensor nuts on all 4 corners of the seat.



WEIGHT SENSOR NUT

WEIGHT SENSOR

11. Make sure nothing is connected to the frame, then slowly lift the seat and set it aside.

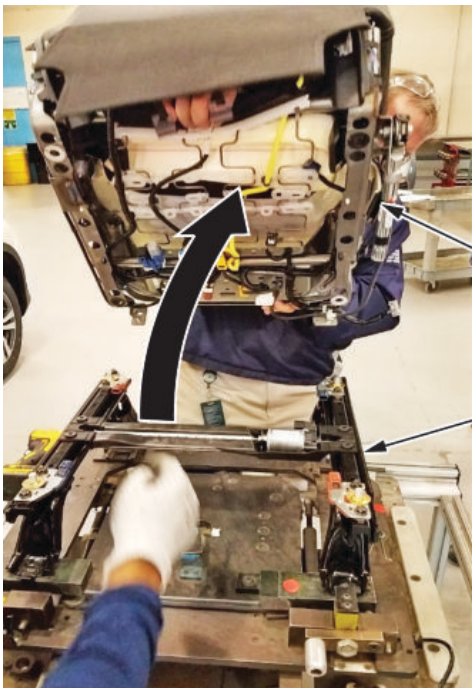

SEAT ASSEMBLY

FRAME  
Do not reuse.

12. Remove the weight sensor collars.

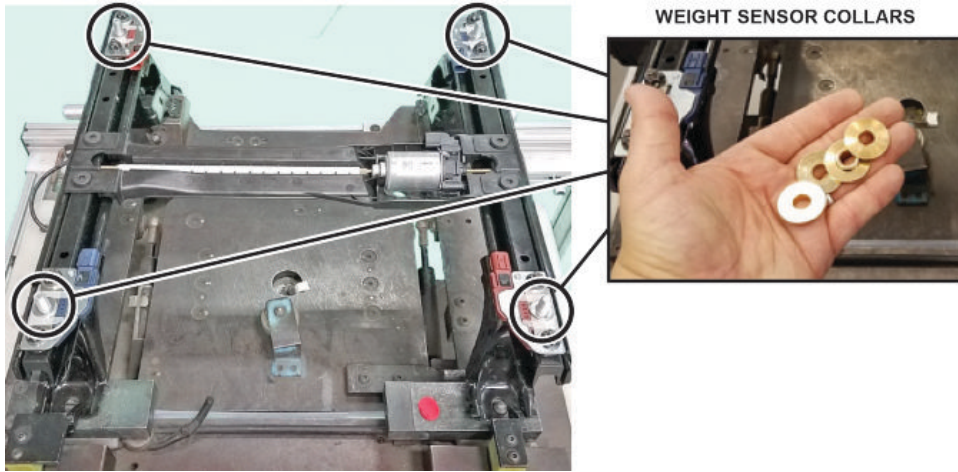

13. Make sure the new frame is for the passenger's side, and replace the original passenger's seat frame.

14. Install the weight sensor collars.

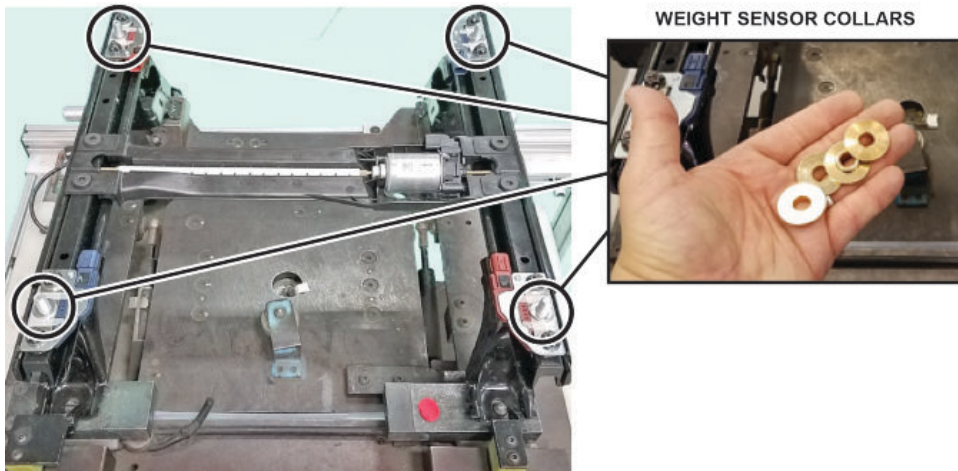

15. Slowly place the passenger's seat onto the new frame.

**NOTE**

Make sure nothing gets pinched between the seat and frame.

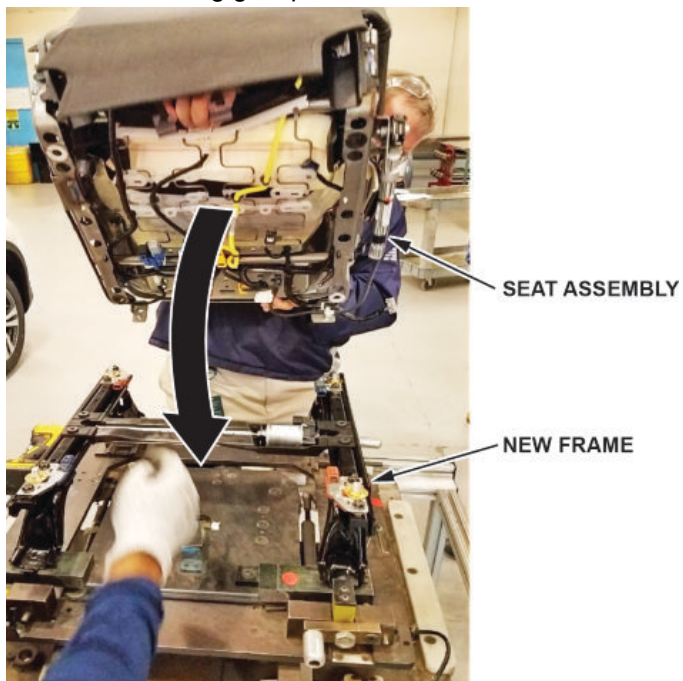

16. Make sure the collar is centered, and there is no gap between the seat and frame.

**GOOD**



COLLAR CENTERED

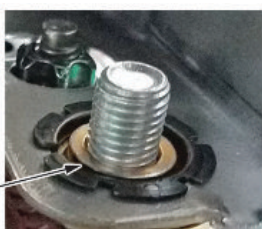

NO GAP



**NO GOOD**



COLLAR OFF-CENTER



GAP



17. Install and hand tighten the nuts, then torque them to **52 N·m (38 lb-ft)** in the sequence shown.

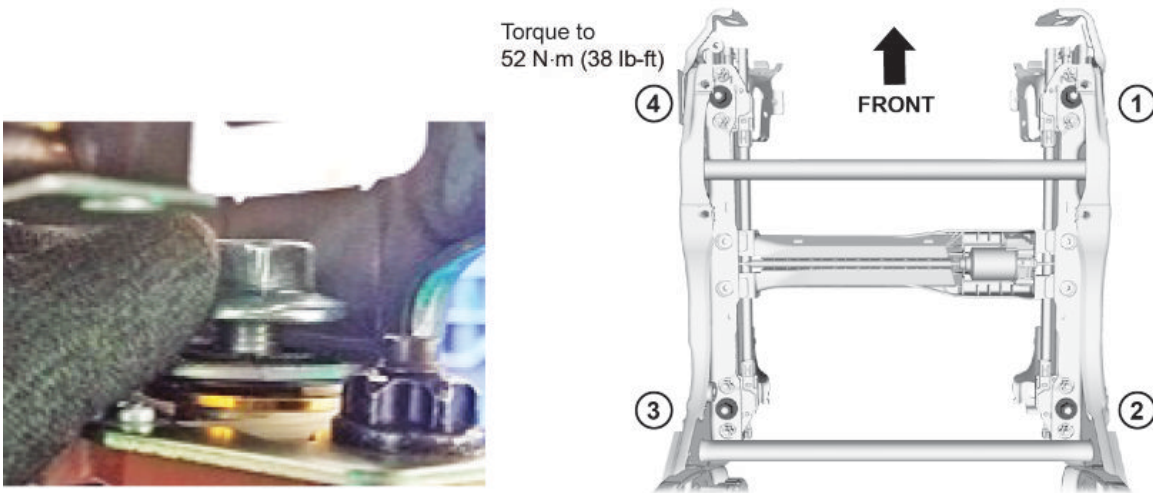

18. Install all removed parts on the passenger's seat in the reverse order of removal.

19. Once you are finished with both driver's and front passenger's seat repair, go to REPAIR PROCEDURE - INSTALLING THE FRONT SEATS.

### REPAIR PROCEDURE - INSTALLING THE FRONT SEATS

1. Place the seats back into the vehicle.

#### NOTE

Make sure nothing gets pinched between the seat and floor.

2. Lean the seat back to connect the floor harness.

#### NOTE

Check the connector is secure by doing a "push, pull, push" check. Do not pull the wires.

3. Install and hand tighten the bolts first, then torque them to **49 N·m (36 lb-ft)** in the sequence shown.

*DRIVER SIDE*

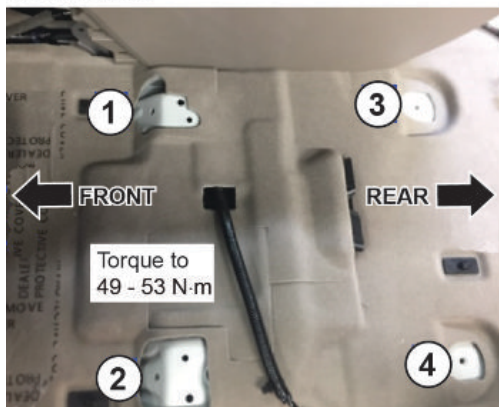

*PASSENGER SIDE*

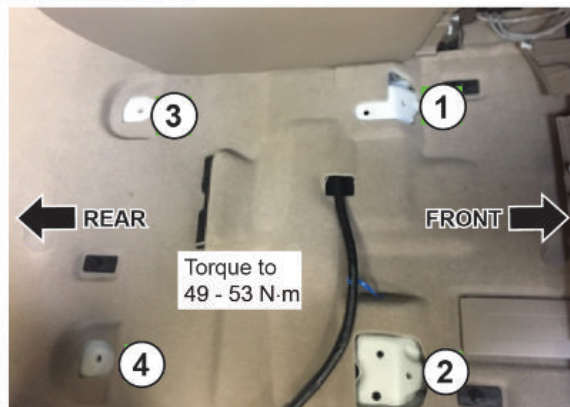

4. After both seats are installed, connect the battery and make sure all the seats functions work properly.

5. **All passenger's power seats except Pilot EX:** Do the Front Passenger's Weight Sensor Initialization Procedure. Refer to the service information.

6. Do the Driving Position Memory Clear Procedure. Refer to the service information.

END