



---

# RECALL CAMPAIGN BULLETIN

---

Reference:

NTB18-021

Date:

March 6, 2018

---

## VOLUNTARY RECALL CAMPAIGN 2018 370Z COUPE; DRIVER CURTAIN AIR BAG MODULE

**CAMPAIGN ID #:** R1802

**APPLIED VEHICLES:** 2018 370Z Coupe (Z34)

**Check Service COMM or Dealer Business Systems (DBS)  
National Service History to confirm campaign eligibility.**

### INTRODUCTION

Nissan is conducting this voluntary recall campaign on certain specific model year 2018 370Z Coupe vehicles. The driver curtain air bag module will be inspected and if necessary, adjusted. This service will be performed at no charge to the customer for parts or labor.

### IDENTIFICATION NUMBER

Nissan has assigned identification number R1802 to this campaign. This number must appear on all communication and documentation of any nature dealing with this campaign.

### DEALER RESPONSIBILITY

It is the dealer's responsibility to check Service COMM or Dealer Business Systems (DBS) National Service History for the campaign status on each vehicle falling within the range of this voluntary safety recall which for any reason enters the service department. This includes vehicles purchased from private parties or presented by transient (tourist) owners and vehicles in a dealer's inventory. **Federal law requires that new vehicles in dealer inventory which are the subject of a safety recall must be corrected prior to sale. Failure to do so can result in civil penalties by the National Highway Traffic Safety Administration.** While federal law applies only to new vehicles, Nissan strongly encourages dealers to correct any used vehicles in their inventory before they are retailed.

Nissan Bulletins are intended for use by qualified technicians, not 'do-it-yourselfers'. Qualified technicians are properly trained individuals who have the equipment, tools, safety instruction, and know-how to do a job properly and safely. NOTE: If you believe that a described condition may apply to a particular vehicle, DO NOT assume that it does. See your Nissan dealer to determine if this applies to your vehicle.

## REPAIR OVERVIEW

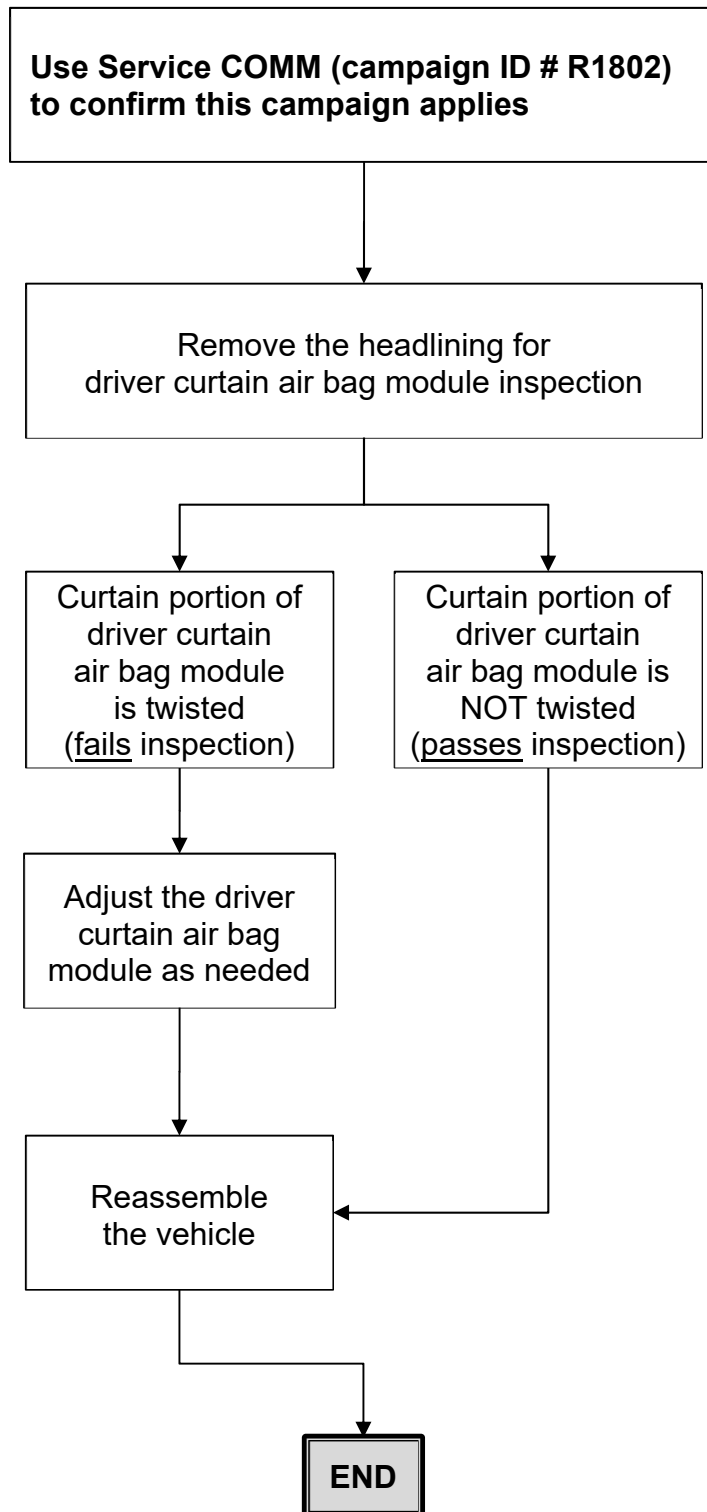

## SERVICE PROCEDURE

### Removal: Headlining

**IMPORTANT:** Follow all warnings, cautions, and notes in the Electronic Service Manual (ESM) when working on or near a Supplemental Restraint System (SRS), such as an air bag.

#### NOTE:

- Use protective covering for all interior surfaces as needed while performing this procedure.
- Always use plastic interior trim tools.
- Make sure hands/gloves are clean when working on the vehicle's interior.
- Store all removed parts in a clean area where they will not get damaged.
- Throughout this repair procedure, when the part is the same on both sides of the vehicle, there may be only one picture of that part regardless of which side. The procedure to remove or install these parts on each side will be the same.

1. Turn the ignition ON with engine OFF.

2. Lower both driver and passenger door windows.

3. Turn the ignition OFF, disconnect the negative battery cable, and then wait for at least three (3) minutes.

4. Remove the left hand and right hand (LH and RH) kicking plates inner (see Figure 1 and 2).

△ = Pawl

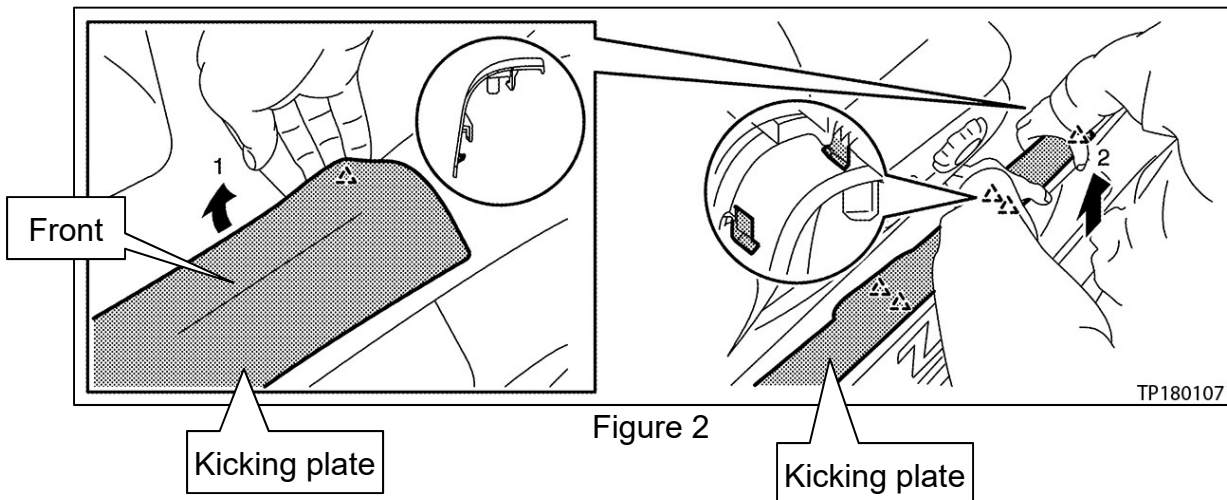
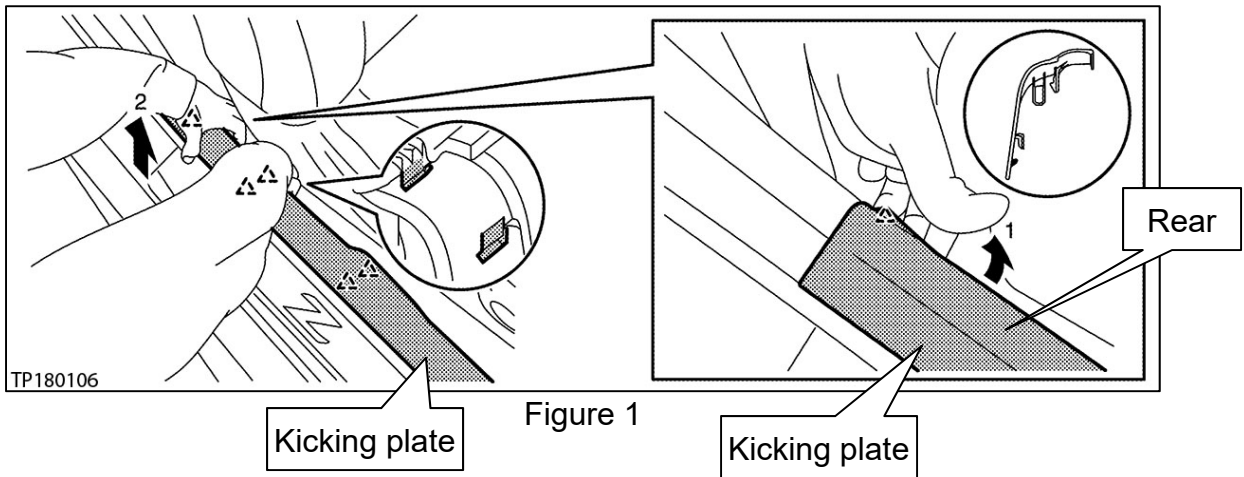

5. Remove the LH and RH dash side finishers.

- Remove the plastic nut.
- Use a suitable plastic pry tool.

○ = Clip

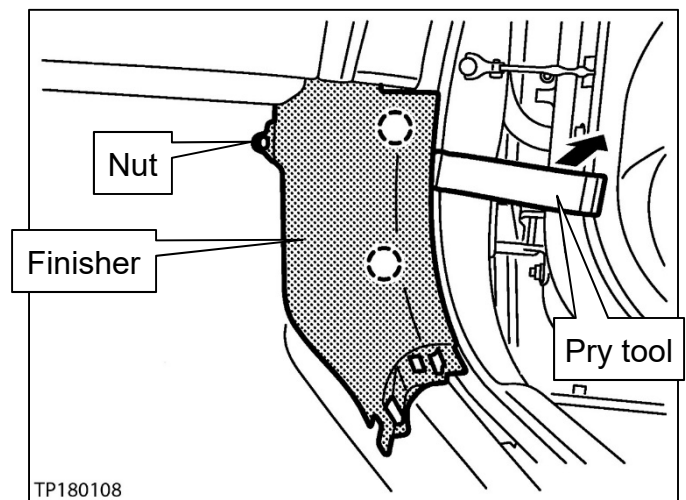

Figure 3

6. Remove the LH and RH body side welts.



Figure 4

7. Remove the LH and RH pillar garnishes (A pillar finishers).

- a. Disengage the clips with a plastic trim tool.
  - b. Cut the front pillar garnish fixing clips with "side" cutters or other suitable tool.
- NOTE:** The fixing clips will be replaced with new ones (see Parts Information).

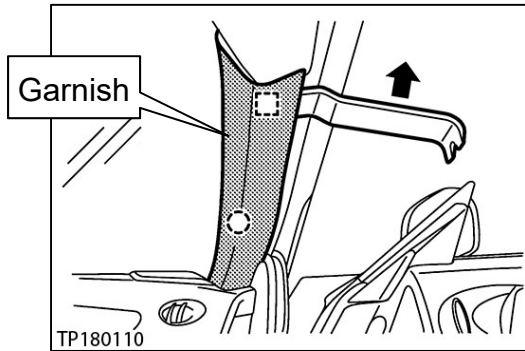

Figure 5

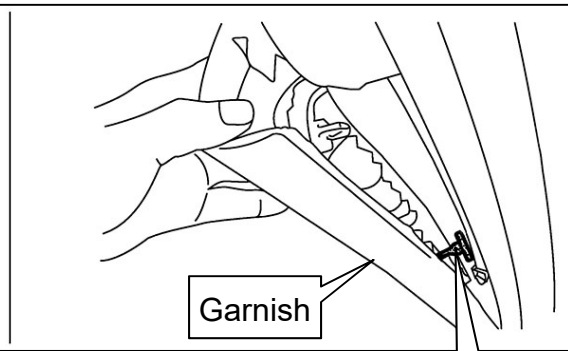



Figure 6

 = Clip

 = Metal clip

- Carefully unfasten the roof assembly harness fixing clips with a pick or similar suitable tool, and then disconnect the related harness connector.

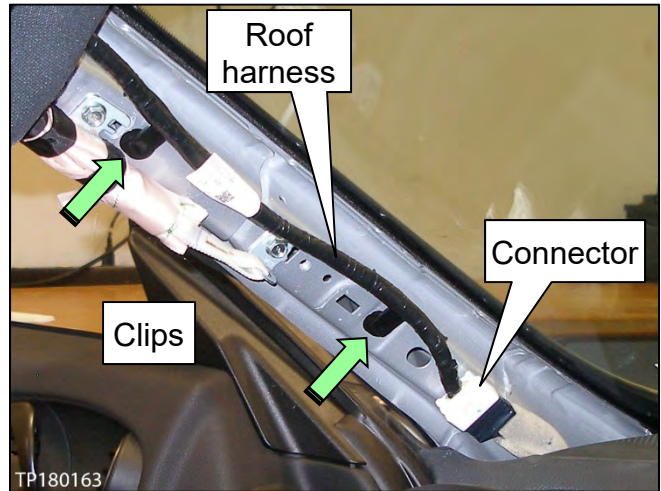

Figure 7

- Work the pick under the lip of the clip, press in on its pawl, and then lift out.

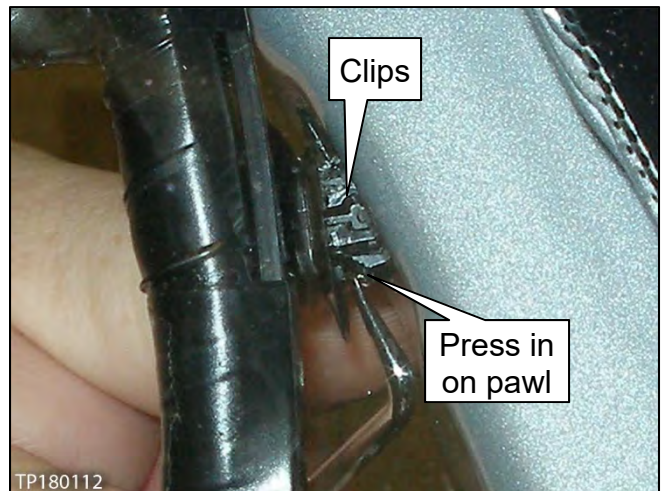

Figure 8

- If equipped: Disconnect the inside mirror assembly harness connector.

**NOTE:** Do not remove the inside mirror assembly. Mirrors without an electrical connection that have been removed will need to be replaced (one-time use/installation).

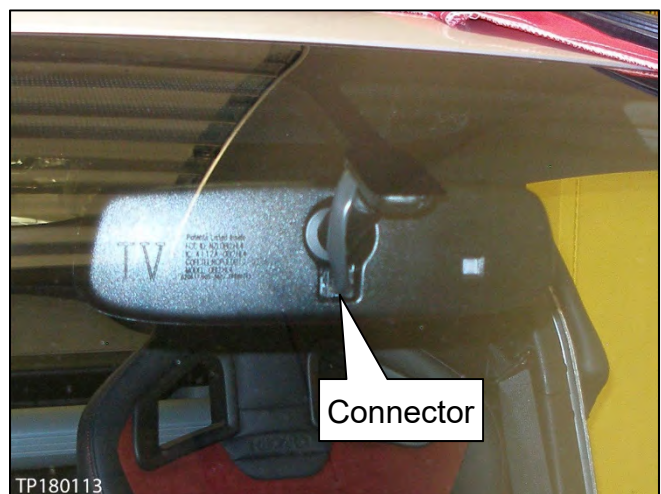

Figure 9

10. If equipped: Remove the inside mirror finisher.



Figure 10

11. Remove the LH and RH sun visors:

a. Carefully remove the sun visor covers.

- Using a pick or similar suitable tool to unsnap one corner and finishing removal with your fingers helps prevent tab breakage (see Figure 11, 12, and 13).

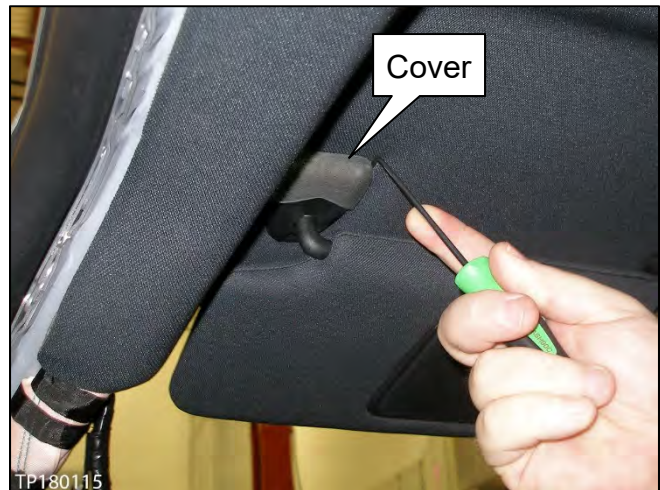

Figure 11

**CAUTION:** If handled too rough, the sun visor cover's tabs can break during removal. Be careful when removing this part.

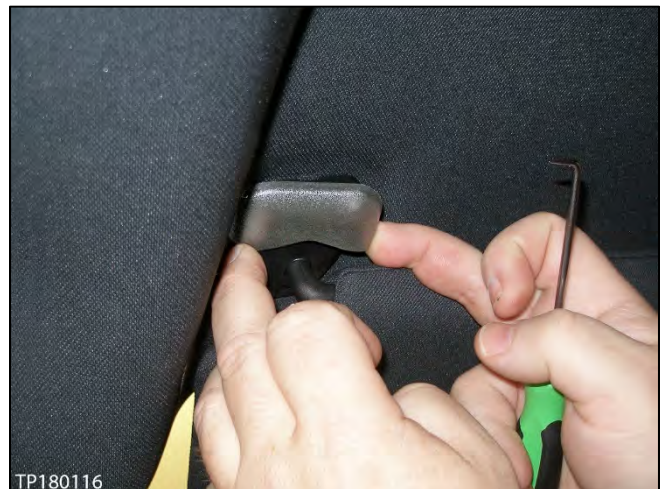

Figure 12

**CAUTION:** If handled too rough, the sun visor cover's tabs can break during removal. Be careful when removing this part.

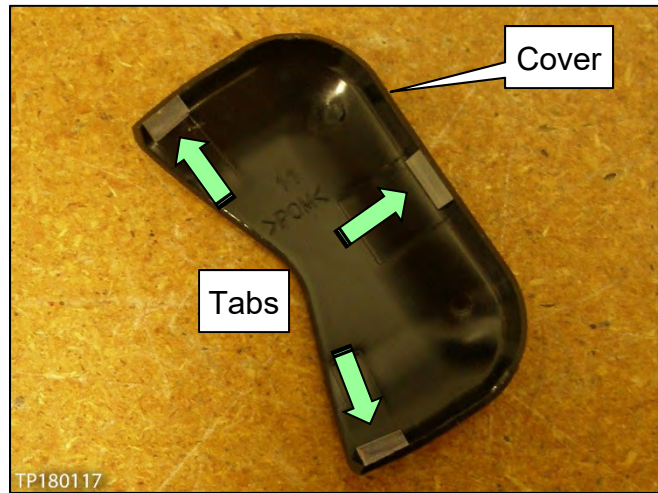

Figure 13

- b. Remove the screws located under the sun visor cover.
- c. If equipped: Carefully pull out the vanity mirror lamp harnesses, and then disconnect the harness connectors.

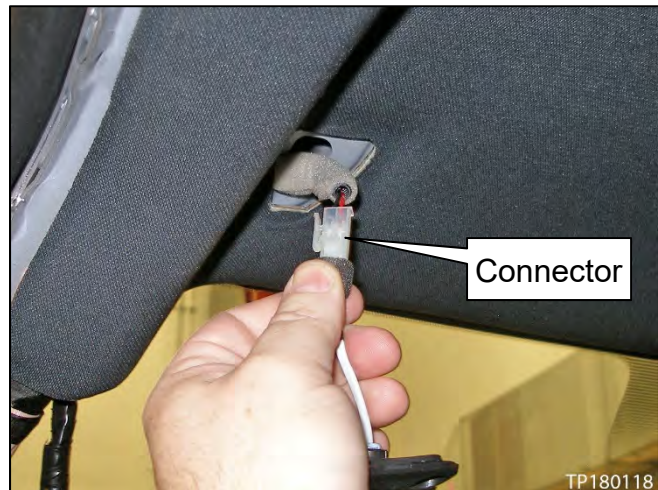

Figure 14

12. Remove the sun visor holders:

- a. Insert a "pocket" screwdriver or similar suitable tool through the slot on the backside of the holders.
- b. Press against the pawl, and then twist the holder 90° counterclockwise.

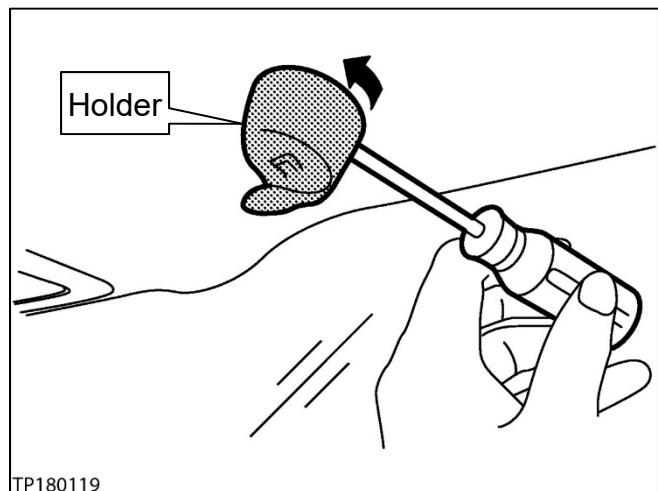

Figure 15



13. Recline both seatbacks forward, and then move both seats in their forward most positions.

14. If equipped: Remove the tonneau cover.

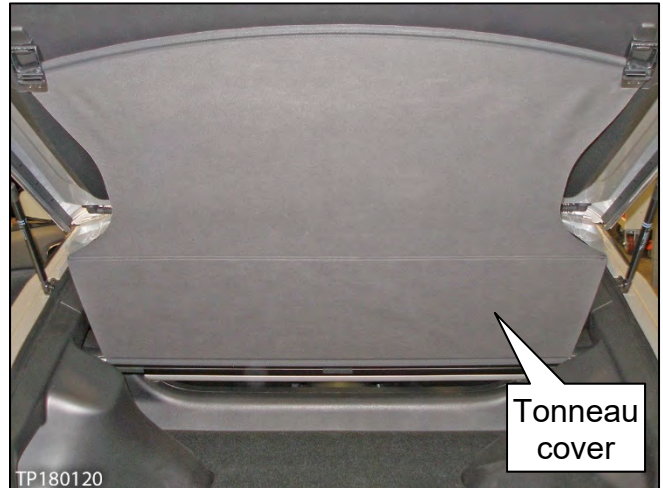

Figure 16

15. Remove the LH and RH rear side finisher mounting bolts (see Figure 17).

16. Remove the LH and RH rear parcel shelf side finishers (see Figure 17).

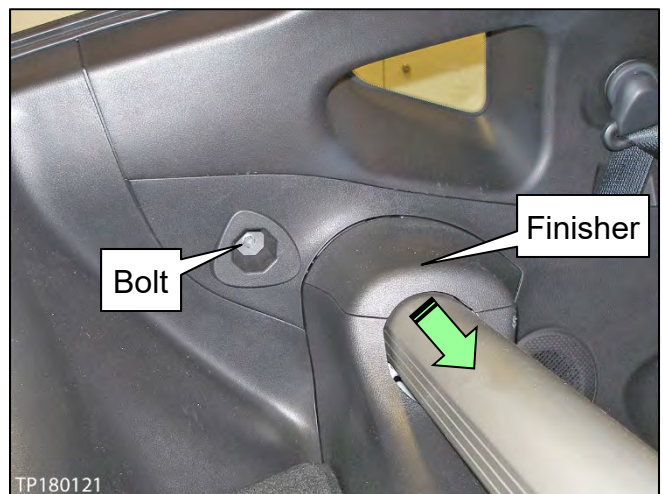

Figure 17

17. Remove the rear parcel shelf finisher holder (see Figure 18 and 19).

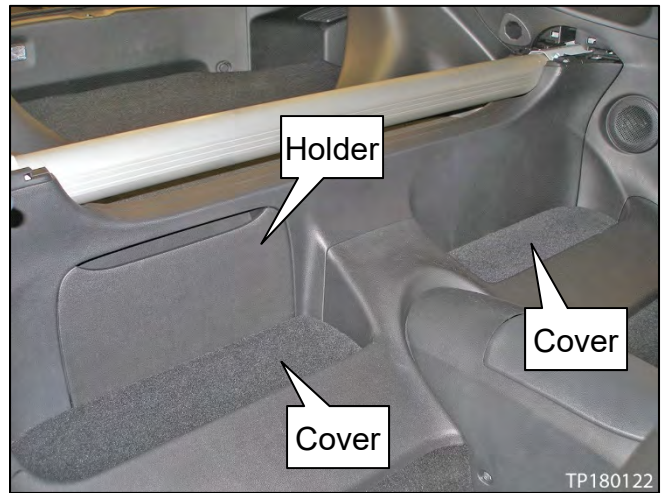

Figure 18

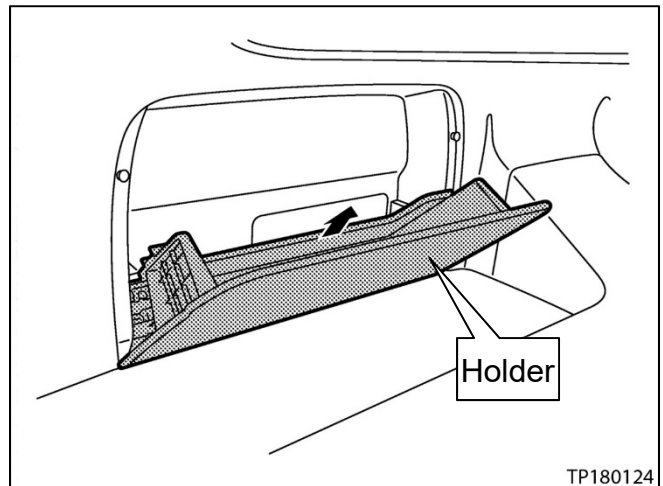

Figure 19

18. Remove the LH and RH rear parcel shelf covers using a suitable plastic pry tool (See Figure 18 and 20).

⊖ = Clip

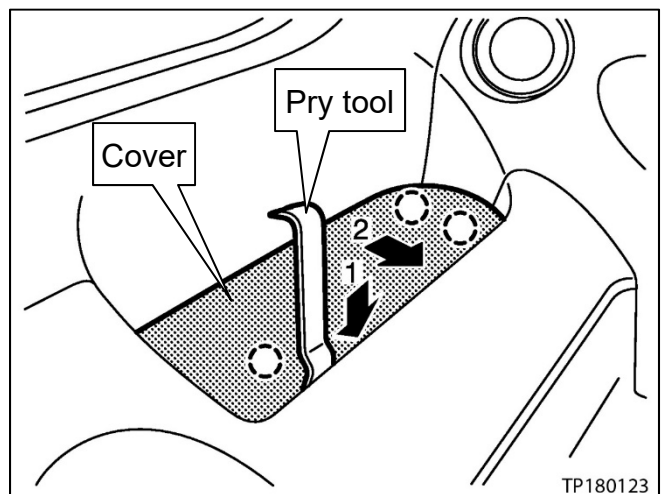

Figure 20

19. Remove the luggage floor carpet.

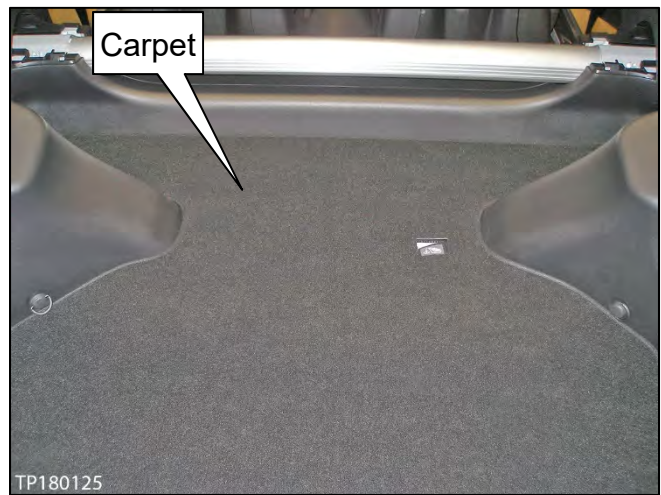

Figure 21

20. Remove the spare tire cover.

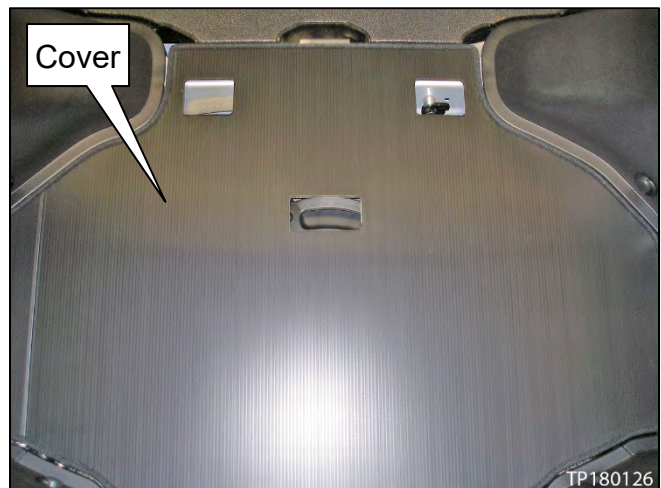

Figure 22

21. Remove the back door weather strip.



Figure 23

22. Remove the rear luggage plate:

- a. If equipped: Remove the luggage trunk net (not shown in picture).
- b. Remove the luggage rear plate fixing trunk net hooks.
- c. Carefully unfasten the rear luggage plate upper clips with a suitable plastic pry tool (see Figure 25 and 26).
- d. Disconnect the luggage rear lamp electrical connector (not shown in picture).
- e. Remove the luggage rear lamp assembly from the luggage rear plate.
  - Lamp removal is for reassembly purposes.

**CAUTION:** Do not remove the luggage rear lamp until AFTER removing the luggage rear plate. Removing it earlier may damage it.

23. Remove the luggage spacer (see Figure 24).

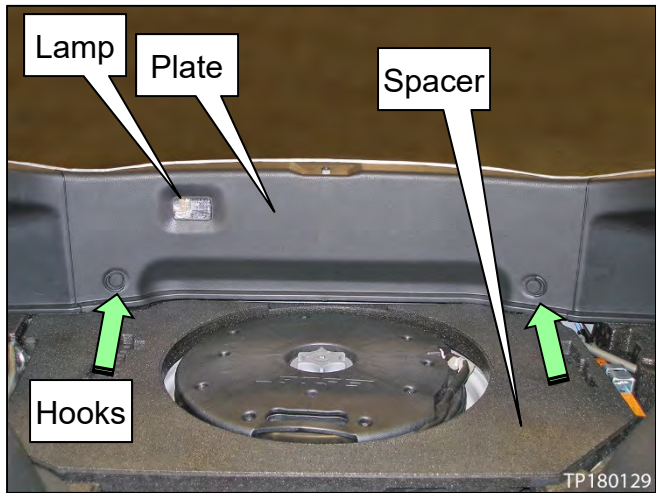

Figure 24

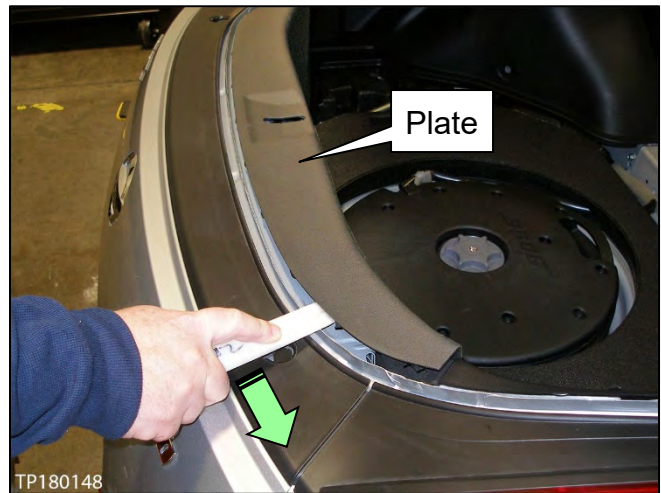

Figure 25

**CAUTION:** Place the plastic pry tool nearest to each clip before prying. Otherwise, damage may occur to the rear luggage plate.

- See clip locations in Figure 26.

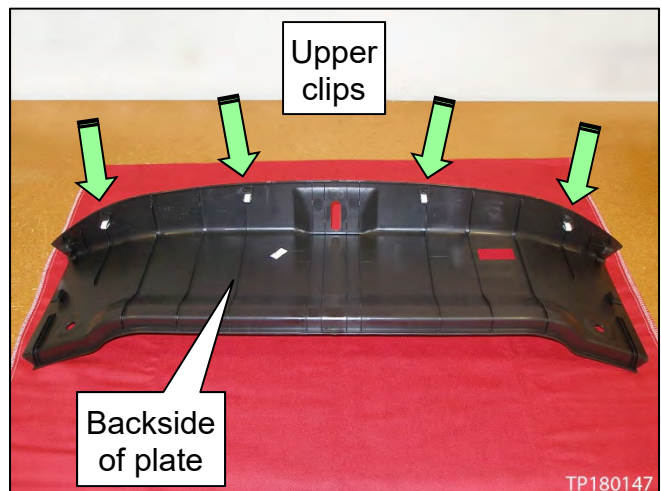

Figure 26

24. Remove the luggage side finisher upper fixing trunk net hooks.

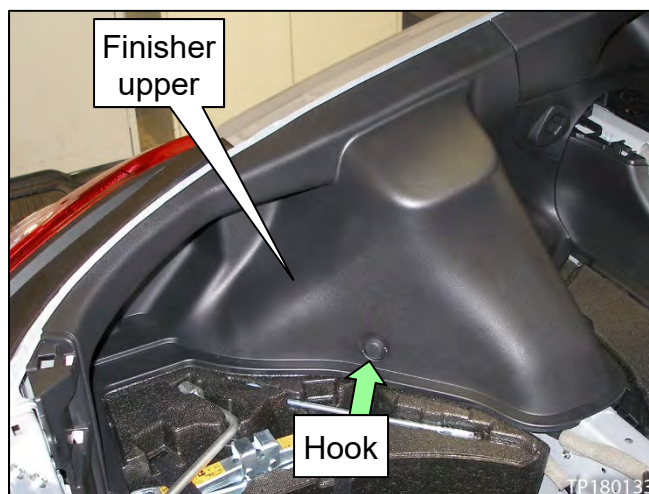

Figure 27

25. Remove the end clips on the LH & RH luggage side finishers upper.

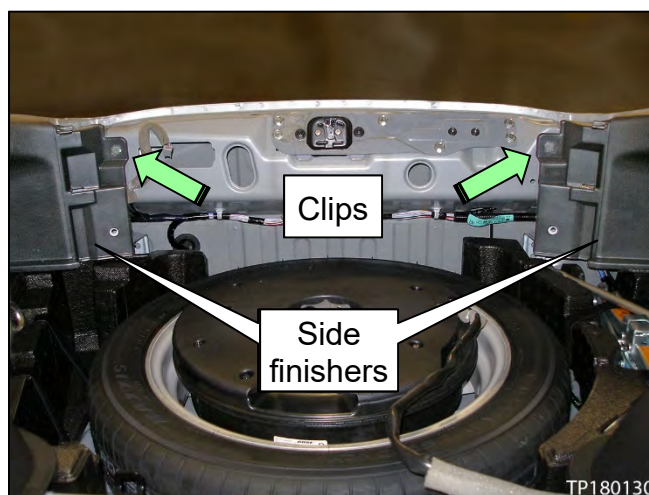

Figure 28

26. Using a suitable plastic pry tool, carefully unfasten the luggage side finisher upper pawls and clips, and then remove the LH & RH luggage side finishers upper.

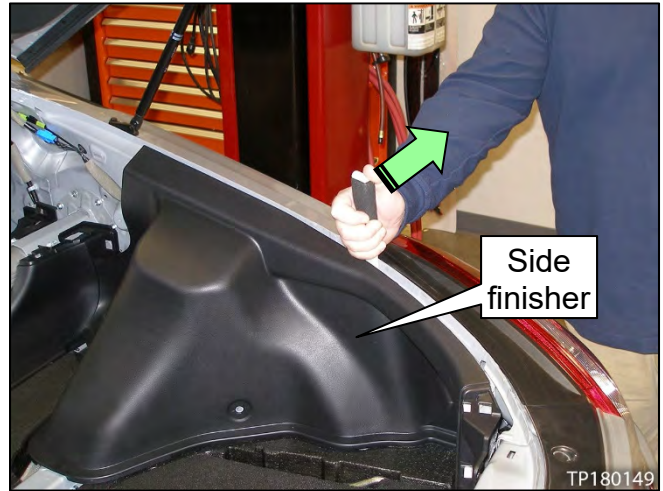

Figure 29

- Pawl and clip locations are shown in Figure 30. Locations are the same on the LH & RH luggage side finishers upper.

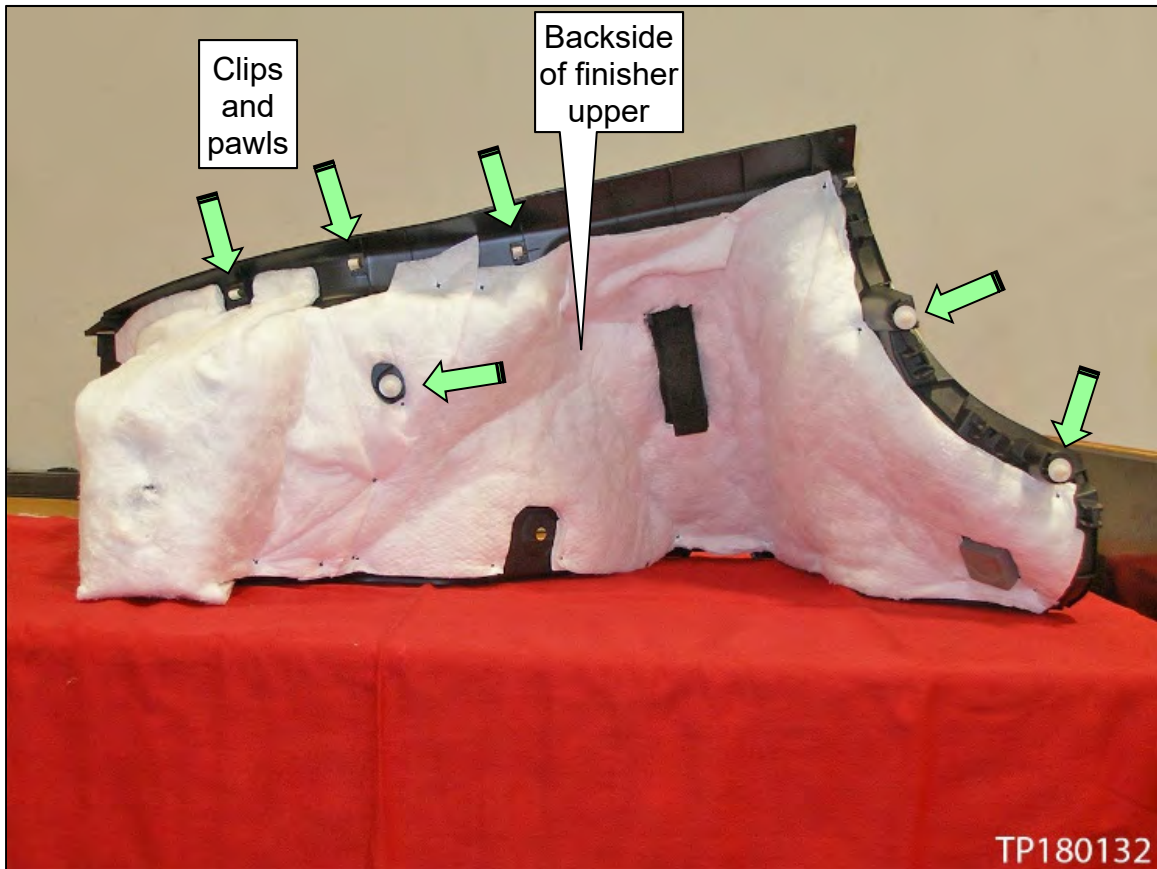

Figure 30

27. Remove the LH & RH rear side finishers:

- a. Carefully unfasten the rear side finisher pawls and clips (see Figure 31 and 32).



Figure 31

- Pawl and clip locations are shown in Figure 32. Clip locations are the same on the LH & RH rear side finishers.

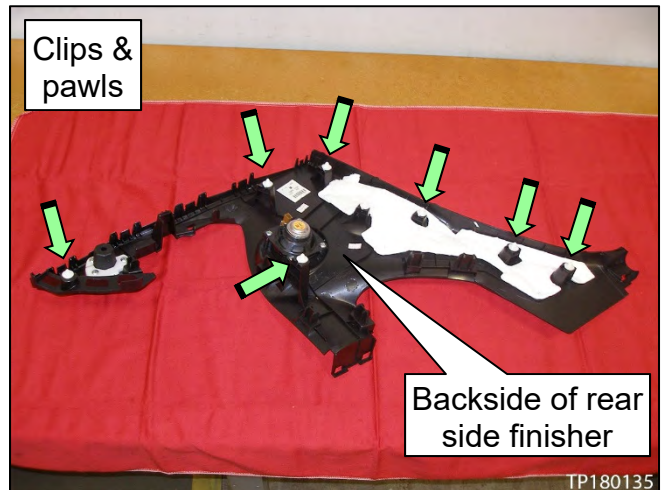

Figure 32

- b. Disconnect the rear speaker harness connectors.

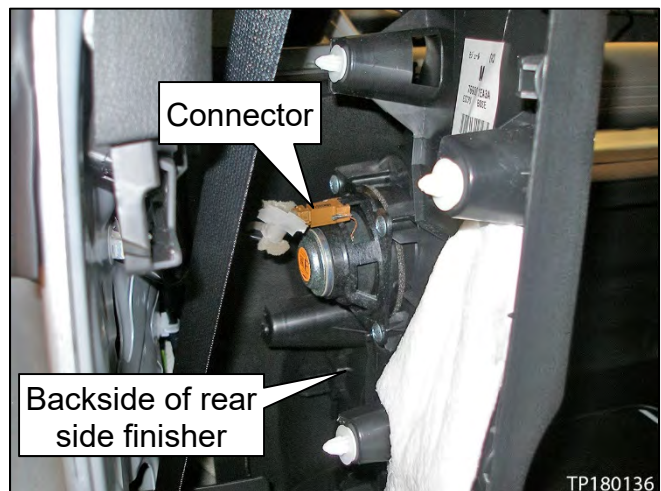

Figure 33

28. Remove the LH & RH rear pillar finishers:

- a. Remove the seat belt shoulder anchor mounting bolt covers, and then remove the bolts (see Figure 34 and 35).

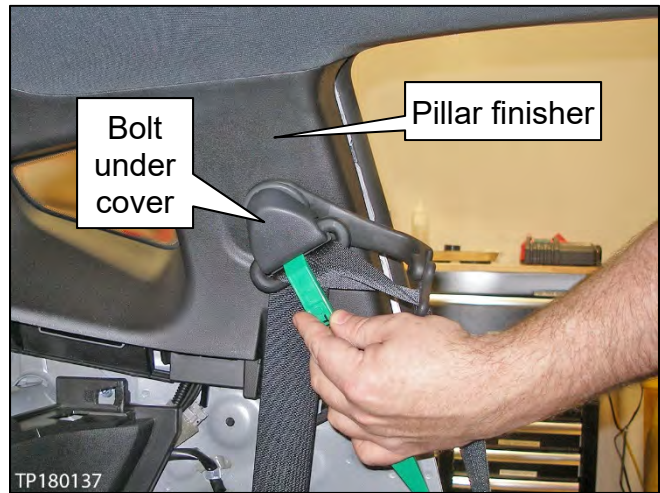

Figure 34

- b. Carefully unfasten the pawls and clips with a suitable plastic trim tool.
  - Pawl and clip locations are shown in Figure 35. Clip locations are the same on the LH & RH rear pillar finishers.

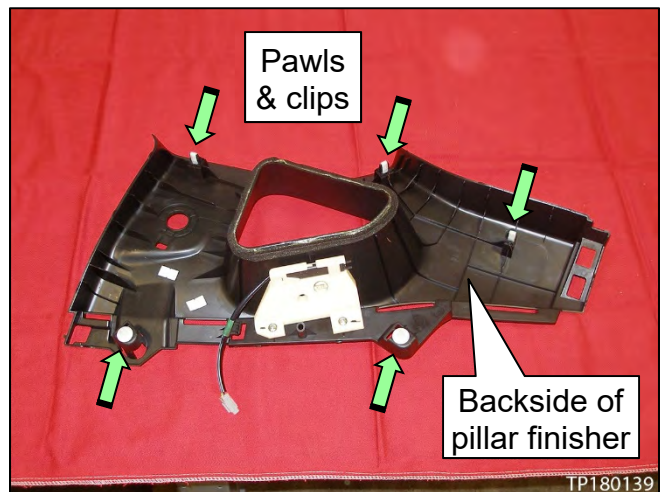

Figure 35

- c. Disconnect the outside key antenna harness connectors.

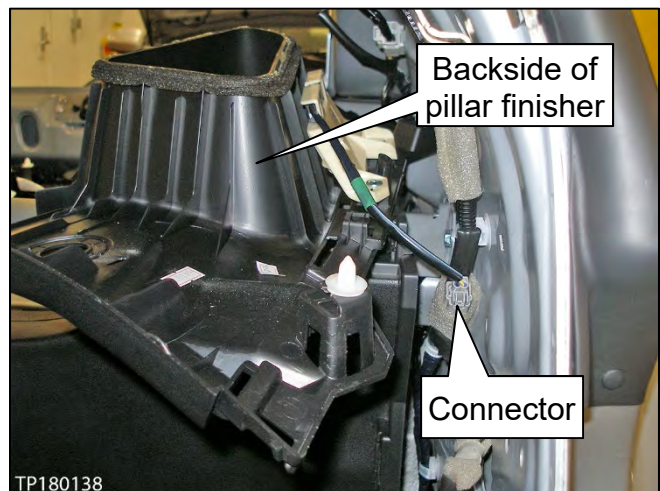

Figure 36



29. Recline both seatbacks, and then move both seats in their rearmost positions.

**NOTE:** When performing steps 30 and 31, the headlining will start to drop down.

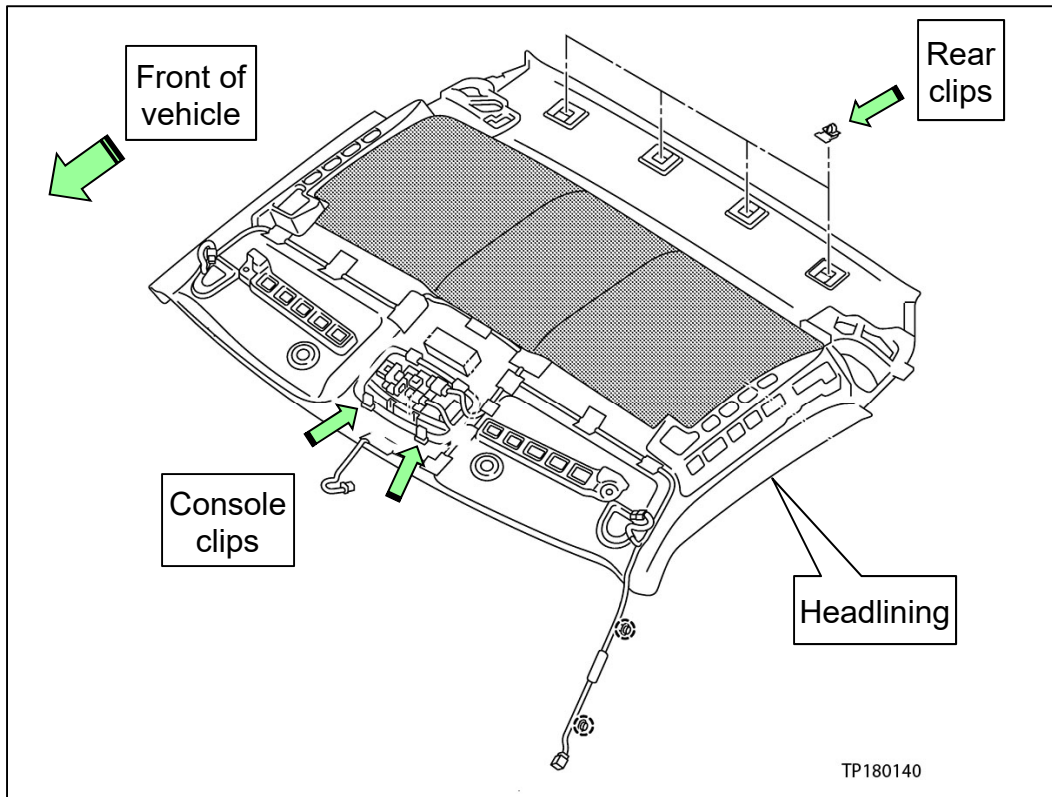

Figure 37

30. Unfasten the roof center console clips (see Figure 37 and 38).

31. Unfasten the rear headlining clips (see Figure 37 and 39).

32. Carefully remove the headlining through the passenger door opening.



Figure 38



Figure 39

Go to "Inspection: Driver Curtain Air Bag Module" on the next page.

## Inspection: Driver Curtain Air Bag Module

33. Inspect the rear section of the driver curtain air bag module:

- See Figure 40, 41, and 42 for examples of OK and NG inspection results.
- If the blue line does not wrap around the backside of the curtain, the driver air bag module is OK. Reassemble the vehicle (go to “Installation: Headlining”).

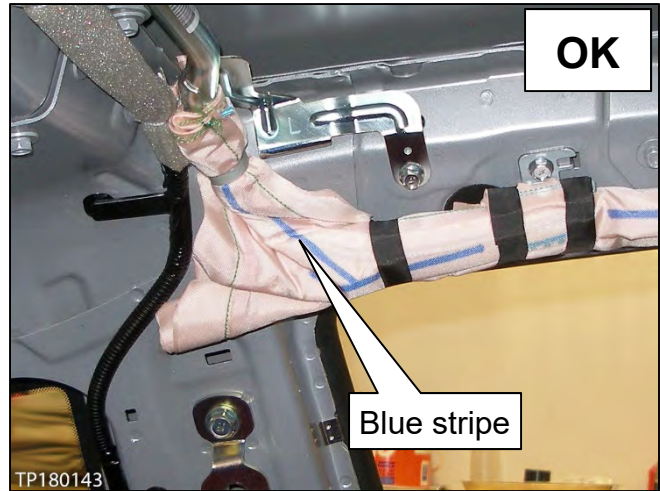

Figure 40

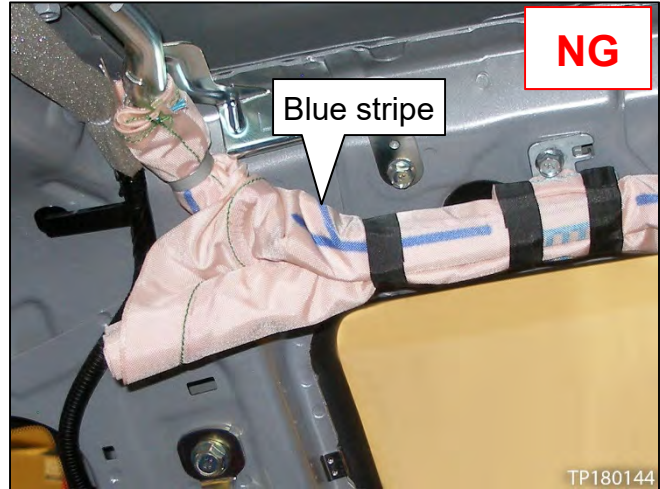

Figure 41

- If the blue line wraps around the backside of the curtain or wrapped where no blue line can be seen (the curtain is twisted), the curtain fails inspection. Go to step 34.

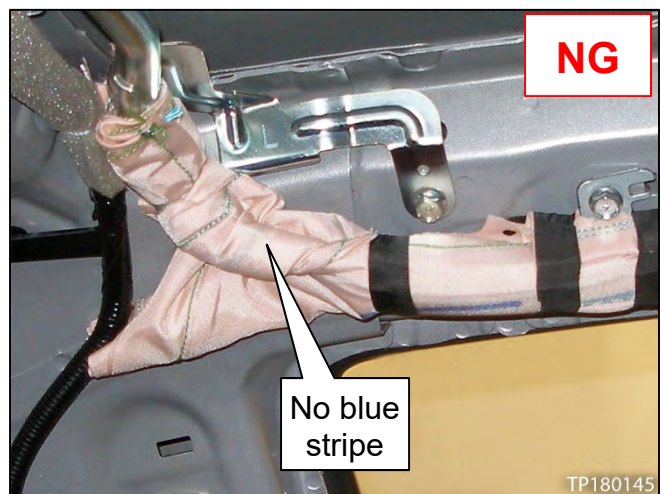

Figure 42

34. Unbolt the four (4) bolts (see Figure 43).

- Do not reuse these bolts, they will be replaced with new ones (see Parts Information).

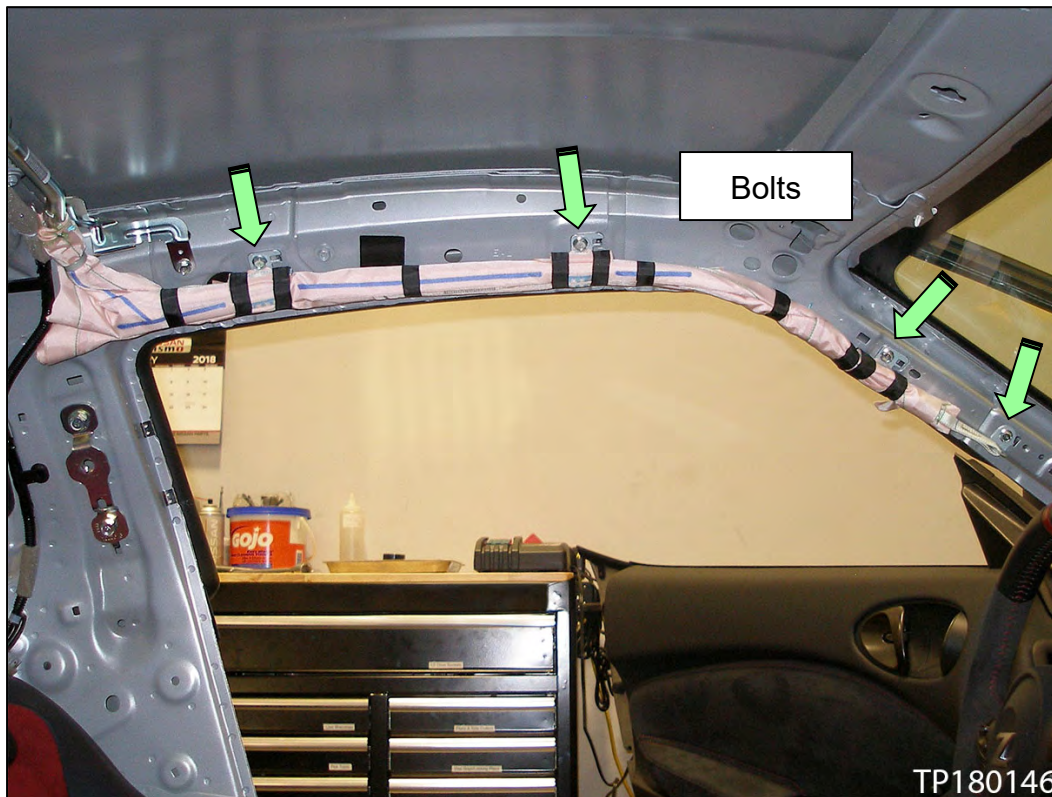

Figure 43

35. Untwist the curtain until all of the blue line is visible or not wrapped around the backside of the curtain (see page 18, Figure 40).

36. Secure the driver curtain air bag module with four (4) new bolts (see Parts Information).

- Bolts torque: 10.8 N•m (1.1 kg-m, **8.0 ft lbs**)

Go to “Installation: Headlining” on the next page.

## Installation: Headlining

1. Carefully put the headlining inside the vehicle through the passenger door opening.
  - Start with the rear of the headlining through the door opening.
2. While holding up the headlining in place, install the LH and RH sun visor holders (see Figure 45).
  - The installed holders will align the headlining's clips with their related holes.
3. Snap in place the headlining rear clips and roof center console clips to the inside of the roof.

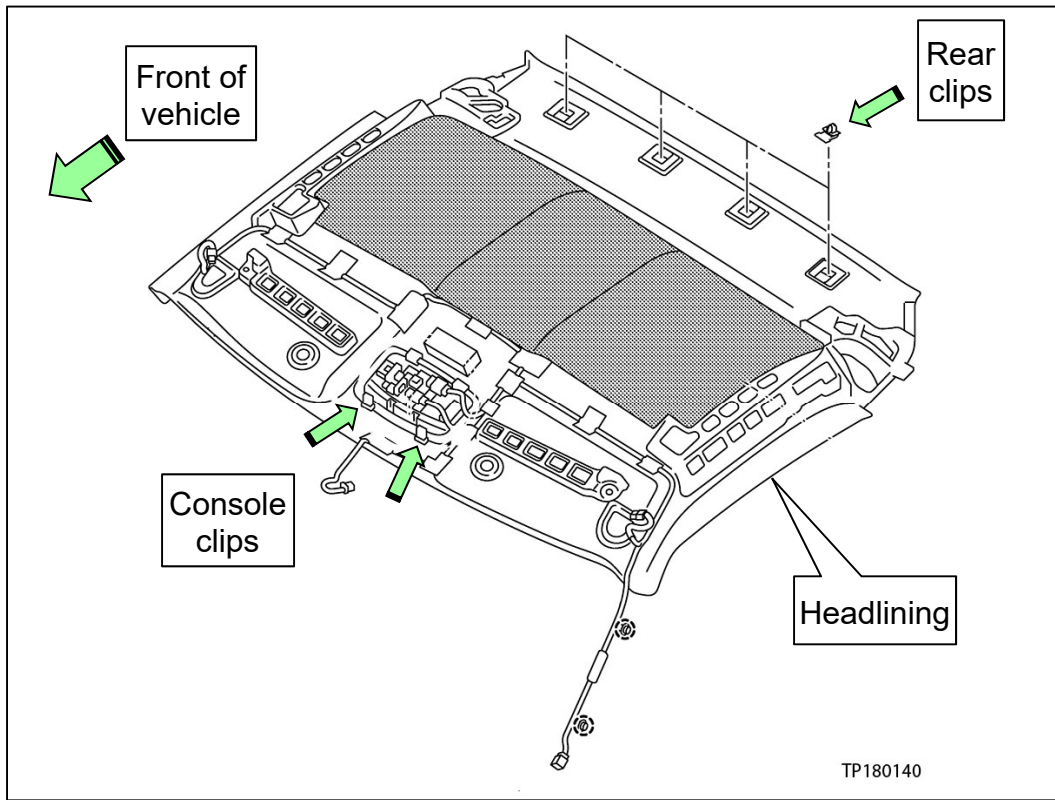

Figure 44



Figure 45

4. Install the LH & RH rear pillar finishers:

- a. Connect the outside key antenna harness connectors.

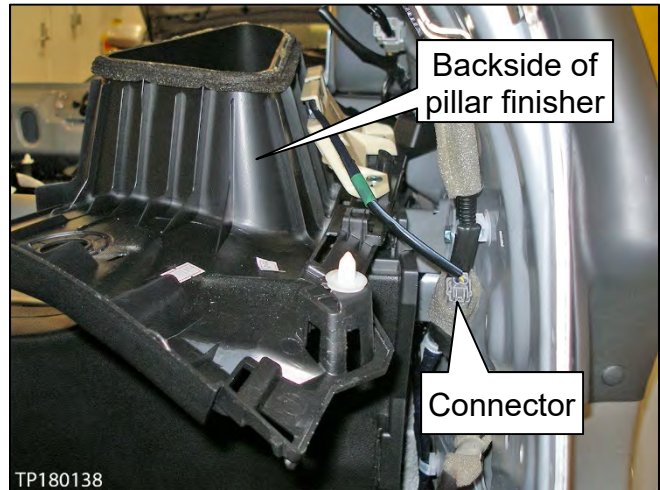

Figure 46

- b. Carefully install the rear pillar finishers.

- c. Install the seat belt shoulder anchor mounting bolts and covers.

- Anchor mounting bolts torque: 49.0 N•m (5.0 kg-m, **36 ft lbs**)

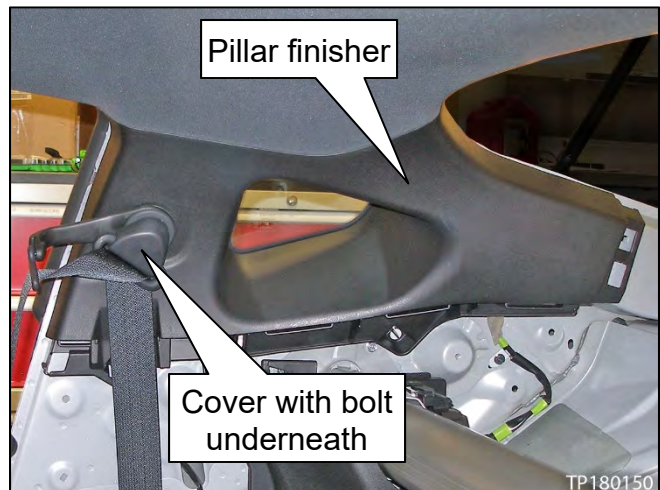

Figure 47

5. Install the LH & RH rear side finishers:

- a. Connect the rear speaker harness connectors.

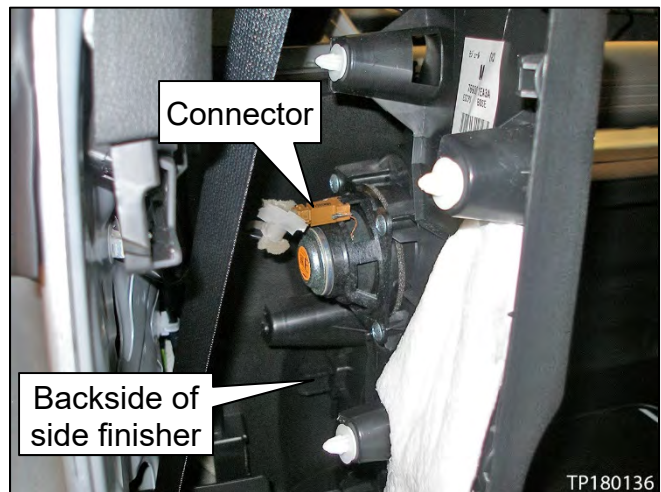

Figure 48

- b. Carefully install the rear side finishers.



Figure 49

6. Carefully install the LH and RH luggage side finishers upper.

7. Install the luggage side finisher upper fixing trunk net hooks.

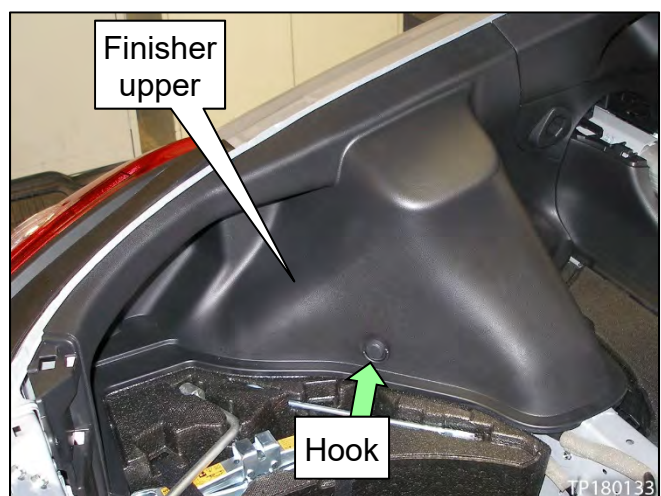

Figure 50

8. Install the LH & RH luggage side finisher upper end clips.

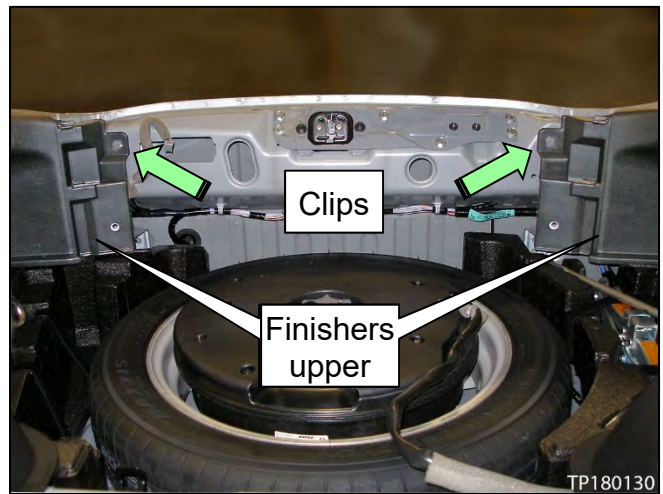

Figure 51

9. Install the luggage spacer.
10. Install the rear luggage plate.
  - a. Put the rear luggage plate in place, but do not fasten in its clips.
  - b. Pull the luggage rear lamp harness connector through the luggage rear plate's opening.
  - c. Carefully fasten the rear luggage plate's upper clips now.
  - d. Connect the harness connector to the luggage rear lamp assembly, and then snap in place the luggage rear lamp.
  - e. Install the luggage rear plate fixing trunk net hooks.

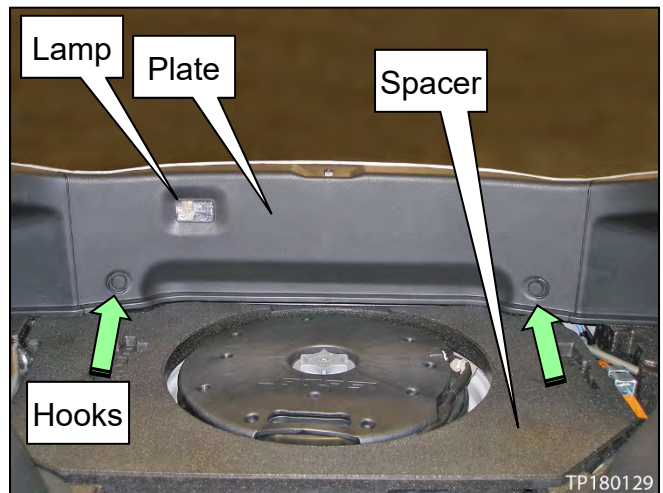

Figure 52

11. Install the back door weather strip.
- When installing, align the weather strip's seam with the back door latch opening in the luggage rear plate.

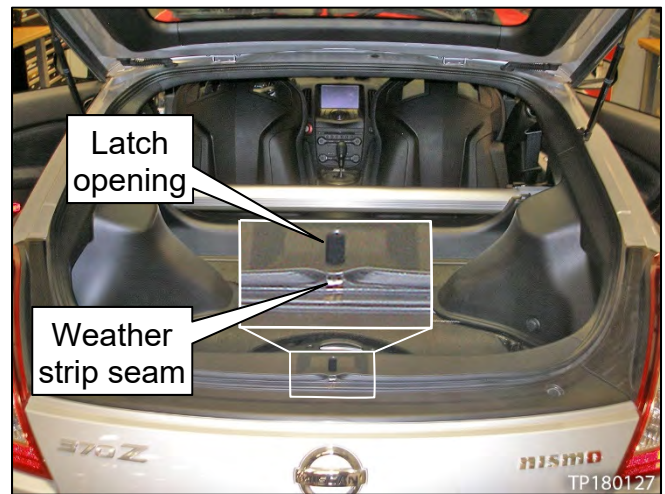

Figure 53

12. Install the spare tire cover.

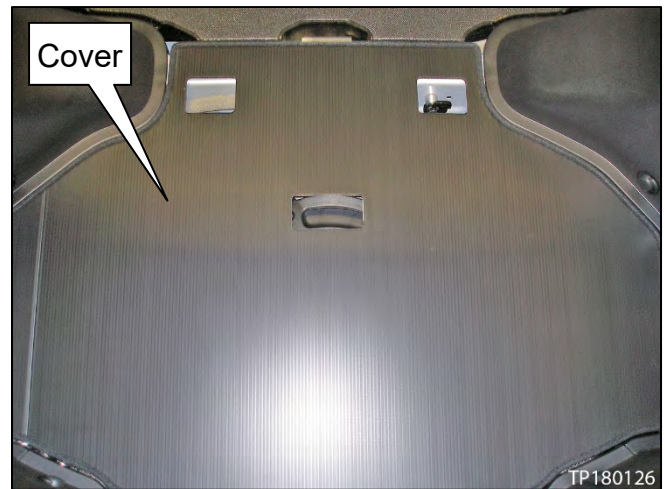

Figure 54

13. Install the luggage floor carpet.
- If equipped: Install the luggage trunk net.

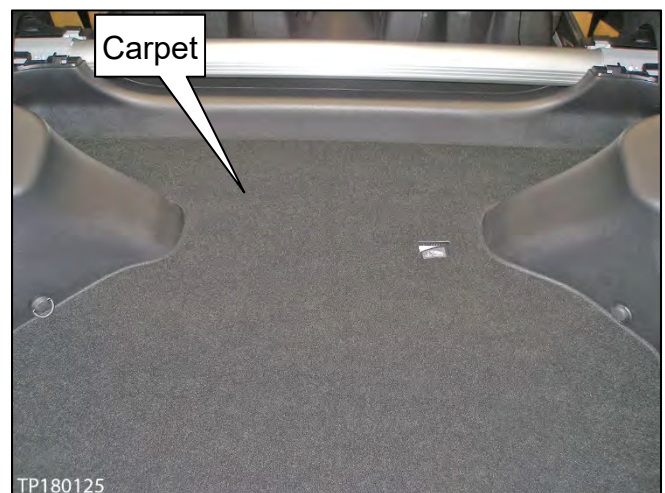

Figure 55



14. Install the LH and RH rear parcel shelf covers.

15. Install the rear parcel shelf finisher holder.

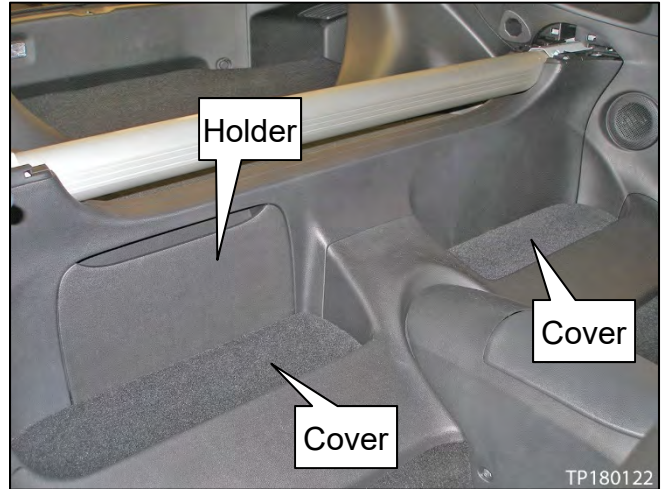

Figure 56

16. Install the LH and RH rear parcel shelf side finishers.

17. Install the LH and RH rear side finisher bolts.

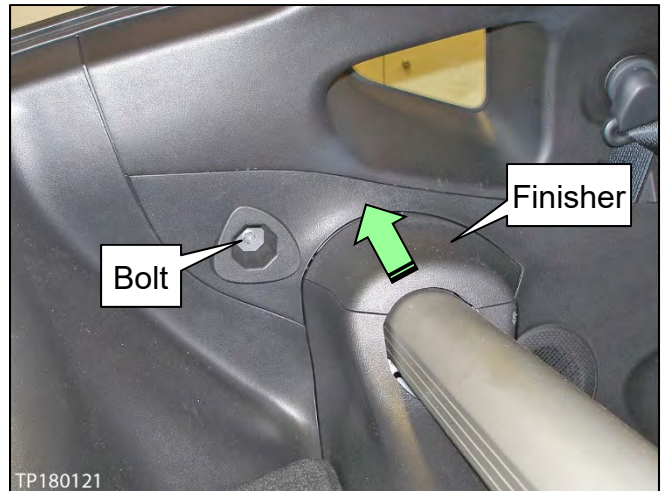

Figure 57

18. If equipped: Install the tonneau cover.



Figure 58

19. Install the LH and RH sun visors:

- a. If equipped: Connect the vanity mirror lamp harness connectors.

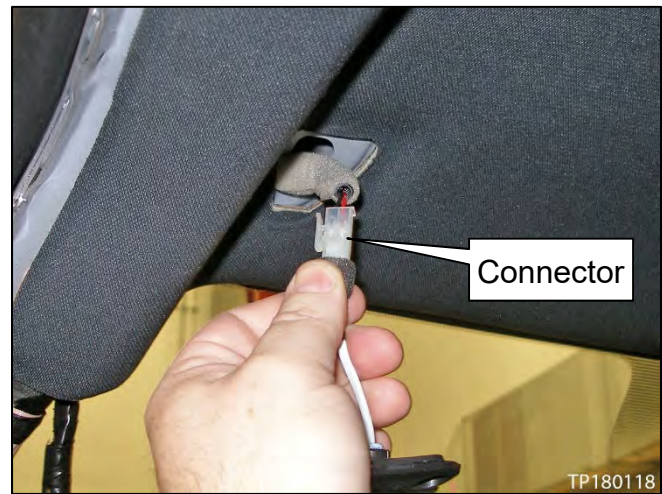

Figure 59

- b. Secure the sun visors with the screws.
- c. Install the sun visor covers (not shown in picture).

**CAUTION: Press in place the covers until all tabs snap in place. Do not hit or force them in place. The tabs may break if hit or forced in place.**

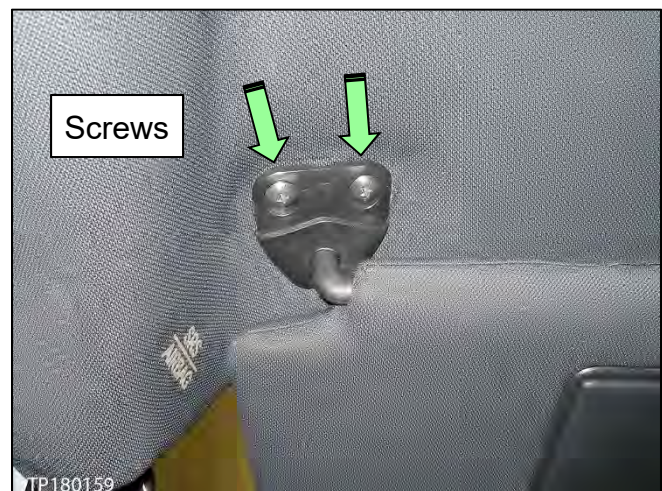

Figure 60

20. If equipped: Connect the inside mirror assembly harness connector.

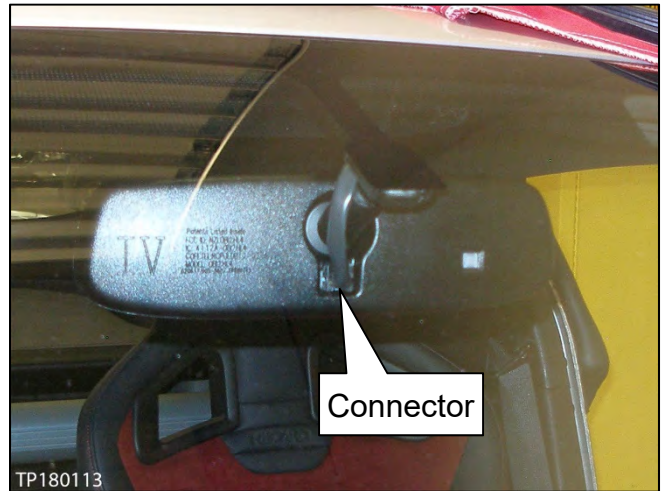

Figure 61

21. If equipped: Install the inside mirror finisher.



Figure 62

22. Fasten the roof assembly harness fixing clips, and then connect the related harness connector.

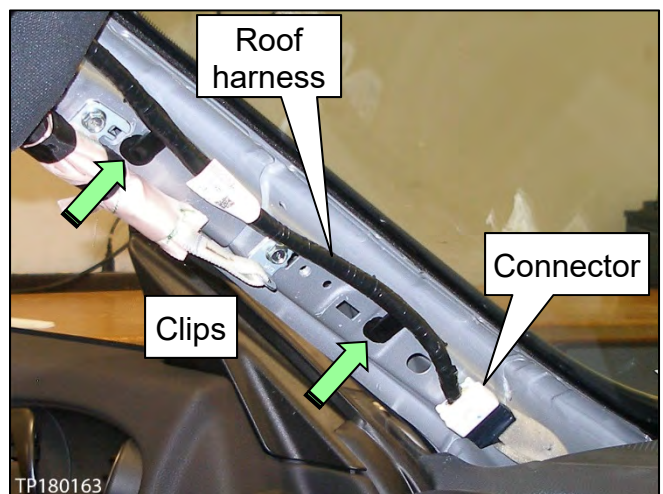

Figure 63

23. Install new front pillar garnish fixing clips on the LH and RH pillar garnishes.

- Use new pillar garnish fixing clips (see Parts Information).

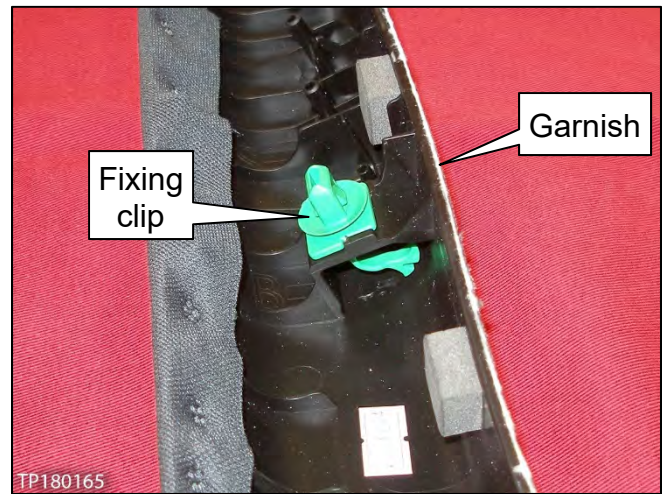

Figure 64

24. Install the LH and RH pillar garnishes.

- Make sure both the metal clips and front pillar garnish fixing clips are fully snapped in place.

25. Install the LH and RH body side welts.



Figure 65

26. Install the LH and RH dash side finishers.

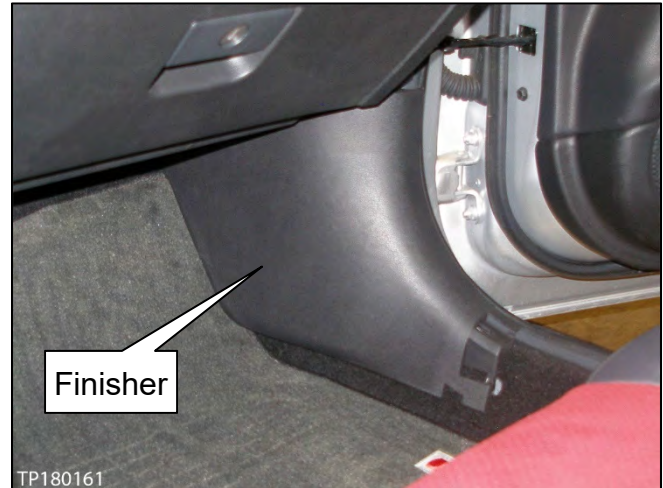

Figure 66

27. Install the LH and RH kicking plates inner.



Figure 67

28. Reconnect the negative battery cable.

29. Reset/reinitialize systems as needed.

- Refer to the ESM, section GENERAL INFORMATION – BASIC INSPECTION – ADDITIONAL SERVICE WHEN REMOVING BATTERY NEGATIVE TERMINAL, for a listing of systems that require reset/initialization after reconnecting the 12 V battery.
- This list often includes items such as the power windows, auto-air conditioning, sunroof, etc.

**PARTS INFORMATION**

DESCRIPTION	PART NUMBER	QUANTITY
CLIP	76988-3DN0A	2
BOLT FLANGE, HEXGON (a)	081A6-6121A	4

(a) This part is needed only if adjustments were made to the driver curtain air bag module.

**CLAIMS INFORMATION**

Submit a “CM” line claim using the following claims coding:

CAMPAIGN (“CM”) ID	DESCRIPTION	OP CODE	FRT
R1802	Inspect Driver Side Curtain Air Bag Assembly (Passes Inspection)	R18020	2.1 hrs
	Inspect Driver Side Curtain Air Bag Assembly (Fails Inspection) And Adjust Curtain	R18021	2.2 hrs

