



SAFETY RECALL BULLETIN

SUBJECT:			No: SR-18-004
OUTLANDER SPORT WINDSHIELD WIPER LINK – SAFETY RECALL CAMPAIGN			DATE: February 2018
			MODEL: 2011–2016 Outlander Sport / RVR
CIRCULATE TO:	<input checked="" type="checkbox"/> GENERAL MANAGER	<input checked="" type="checkbox"/> PARTS MANAGER	<input checked="" type="checkbox"/> TECHNICIAN
<input checked="" type="checkbox"/> SERVICE ADVISOR	<input checked="" type="checkbox"/> SERVICE MANAGER	<input checked="" type="checkbox"/> WARRANTY PROCESSOR	<input checked="" type="checkbox"/> SALES MANAGER

PURPOSE

This bulletin provides directions for replacing the windshield wiper link rod.

BACKGROUND

In the event that water drops down through the back side of the front deck garnish (the body piece between the hood and windshield), the front wiper link ball joint may experience excessive moisture and corrode. If this occurs, the resin case of the ball joint will wear prematurely due to the ball joint corrosion and the wiper link may ultimately separate causing the windshield wipers to stop operating.

If wiper link separation occurs, the windshield wipers will become inoperative which could reduce driver visibility under certain conditions and increase the risk of a vehicle crash.

AFFECTED VEHICLES

2011 – 2016 Outlander Sport / RVR

IMPORTANT

Affected new or used inventory vehicles must be repaired before the vehicle is sold/delivered. Dealers must check their inventory vehicles' VINs on the Warranty Superscreen to verify whether the vehicle is involved in this recall campaign. It is a violation of Federal law for a dealer to sell/deliver a new motor vehicle or any new or used item of motor vehicle equipment (including a tire) covered by the notification under a sale or lease until the defect or noncompliance is remedied.

REQUIRED OPERATIONS

Before starting this campaign procedure, CHECK THE WARRANTY SUPERSCREEN to verify if the vehicle is an affected VIN for this campaign and that this campaign procedure has not already been completed. You must also check the Superscreen for any open **SR-16-010 (C1611Z or C1612Z)** campaign. To improve customer satisfaction and to prevent the customer from having to return for a separate repair, you must complete any open **SR-16-010** campaign at the same time as this campaign. The labor allowance for **SR-16-010** has been reduced to encourage the completion of both campaigns at the same time. Portions of **SR-16-010** have been incorporated to enable a smooth completion of both campaigns; however, you must make separate claims for **SR-16-010** and **SR-18-004**.

REQUIRED EQUIPMENT

- Precision Flathead Screwdriver
- Ornament Remover (Trim Stick)
- Bent Nose Pliers (45 Degrees)
- 19 mm Socket
- Adjustable Wrench
- Slip Joint Pliers

- Straight Edge / Ruler
- Hose
- Scissors
- Pry Bar
- Masking Tape
- Marker

WIPER LINK ROD ASSEMBLY REPLACEMENT PROCEDURE

⚠ CAUTION Do NOT mix old parts with new parts.

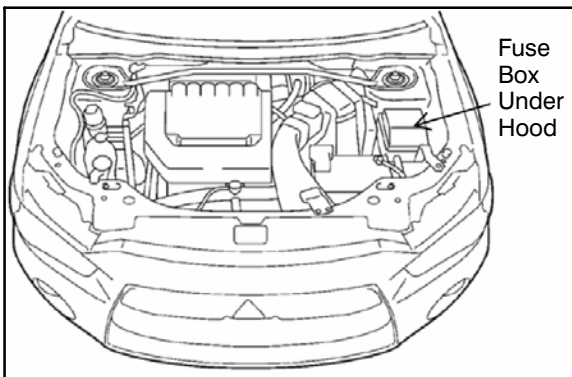

1. Obtain the Fuse Remover from the engine compartment fuse box.

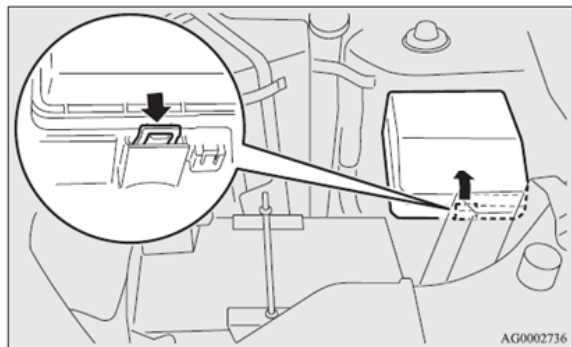

- a. Open the hood.
- b. Unlock the fuse box cover by pushing on the lock lever.

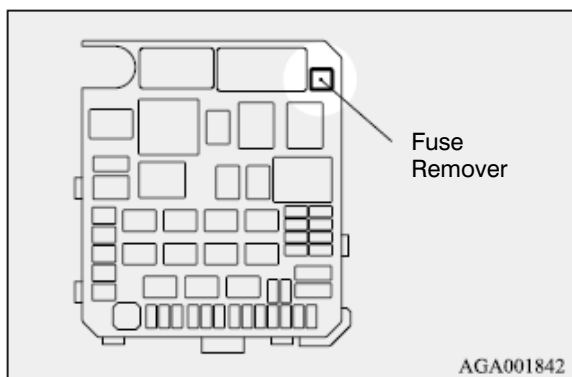

- c. Remove the Fuse Remover.

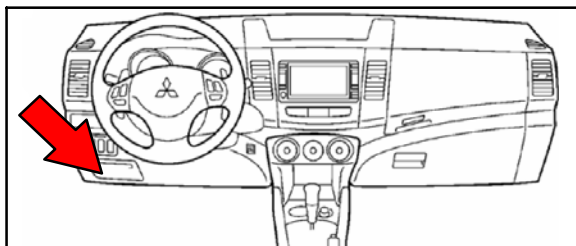

2. Locate the passenger compartment fuse lid.

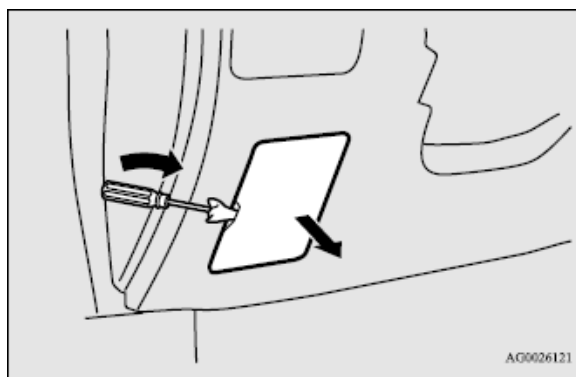

3. Remove the passenger compartment fuse lid.

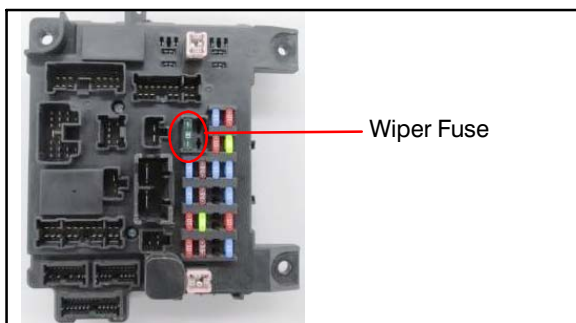

4. Using the Fuse Remover, locate and remove the green (30 A) Wiper Fuse.

Refer to “**How to Use Fuse Remover**” instructions below.

How to Use Fuse Remover

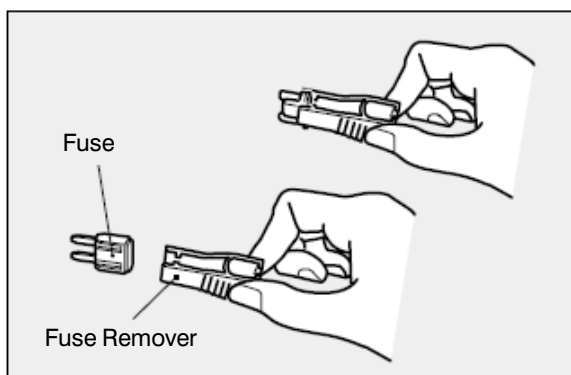

A Fuse Remover MUST be used to remove fuses. Use of other tools such as pliers can potentially result in thermal incidents.

!! IMPORTANT !! Before marking the windshield wiper positions, lift the wiper blade from the windshield and set it back down to ensure that they are resting in their intended positions.

!! IMPORTANT !! Use a fender cover, towel, or similar accessory to protect the fender.

5. Attach masking tape to the windshield and mark the wiper blades' positions as shown.



6. Remove the wiper arm blade assemblies.

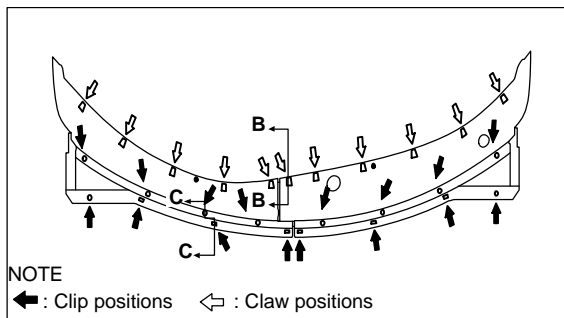

7. Remove front deck garnish.

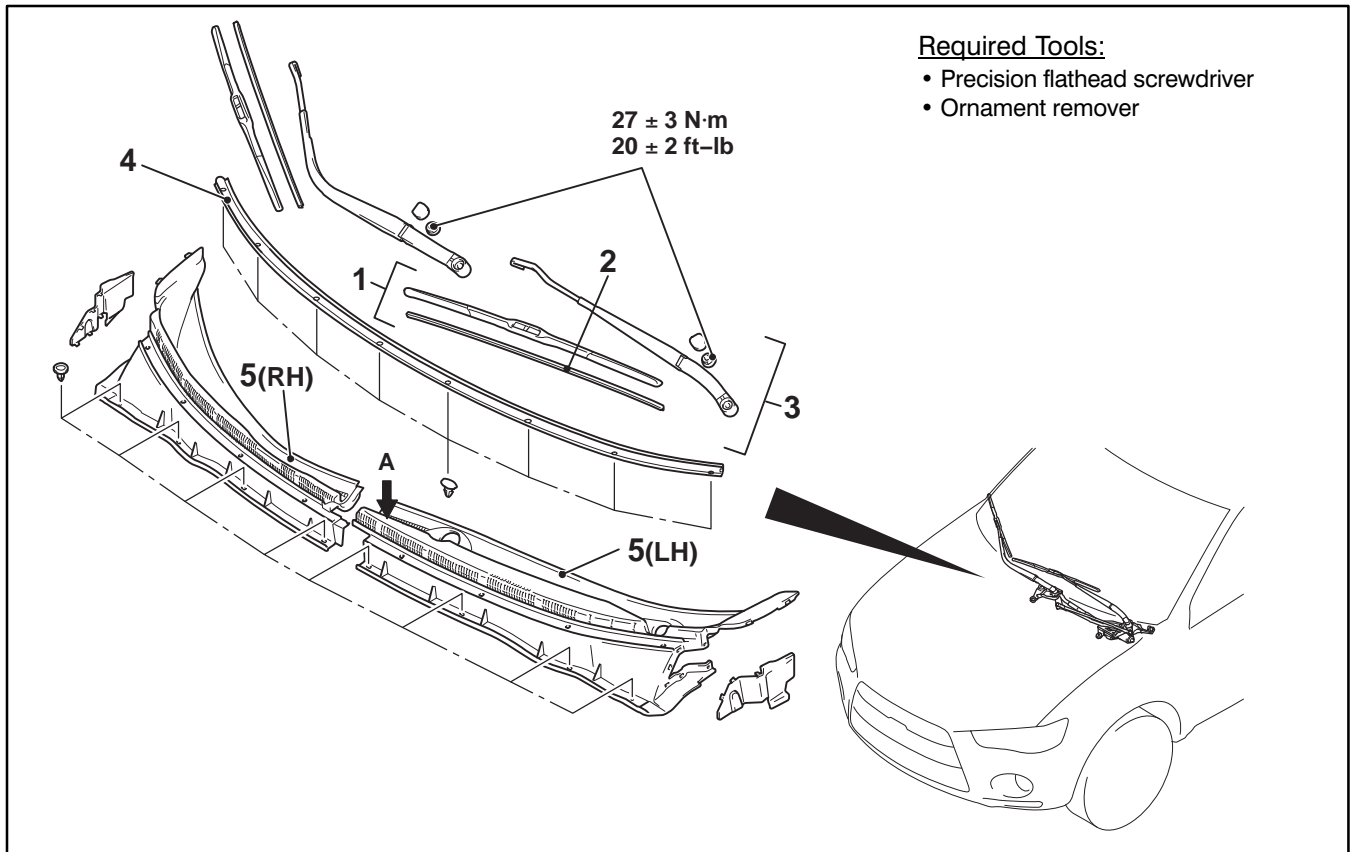

8. Remove the passenger side hood rear weatherstrip from the deck garnish.

NOTE: Do not remove the driver side hood rear weatherstrip from the deck garnish (for easier reassembly).

9. Protect the windshield with a protective slit hose.

a. Make a protective slit hose as shown below.

Making a Protective Slit Hose

1. Hose Length: Approx. 33 in. (85 cm)



2. Cut entire length of hose



Cross Section of hose

Before

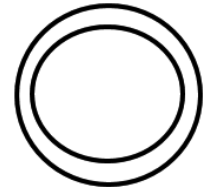

After



- b. Cover the edge of the windshield with the protective slit hose.

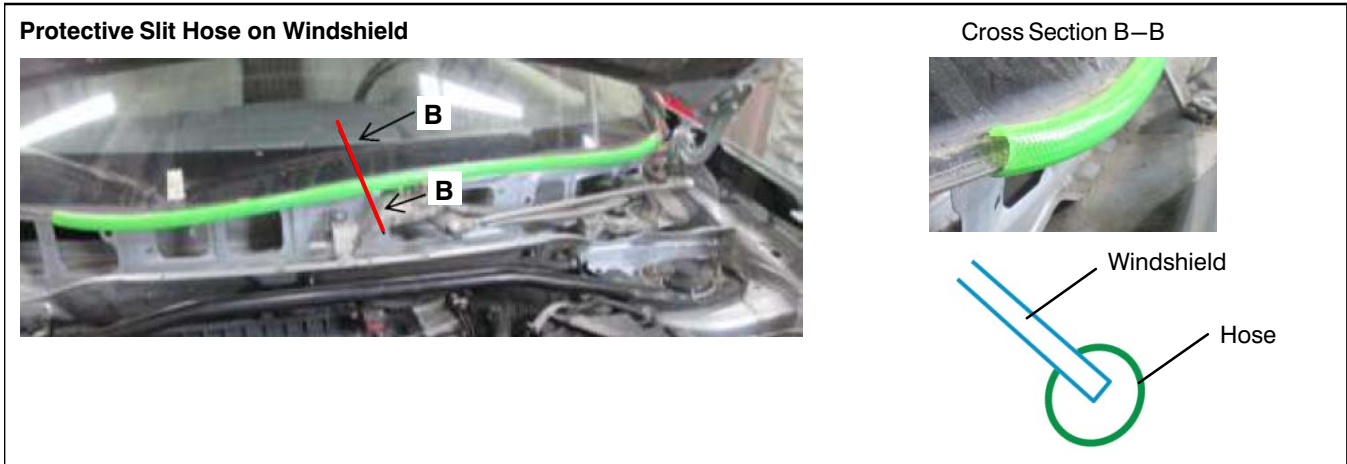

- 10. Unbolt the wiper link assembly, disconnect the wiper motor connector, and remove the wiper link assembly from the vehicle.

CAUTION Clamp the wiper link assembly at the connection pipe only.



- 11. Place the wiper link assembly in a vice with the motor axle pointing up.

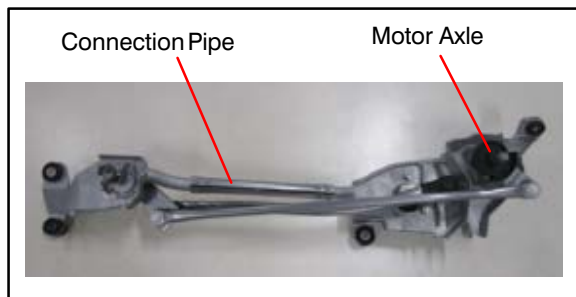

CAUTION: Clamp ONLY the connection pipe section.

12. Use a pry bar or similar device to separate the wiper link rod from the wiper link plate. Insert the pry bar and lift using leverage in area shown below.

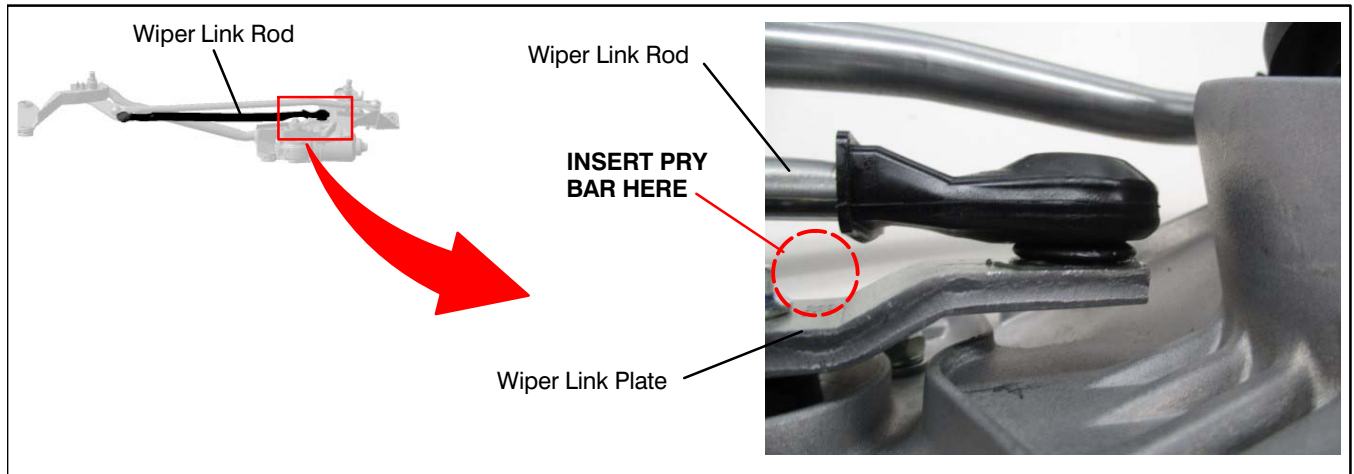
**CAUTION**

Turn the link plate slowly to avoid internal damage to the wiper motor.

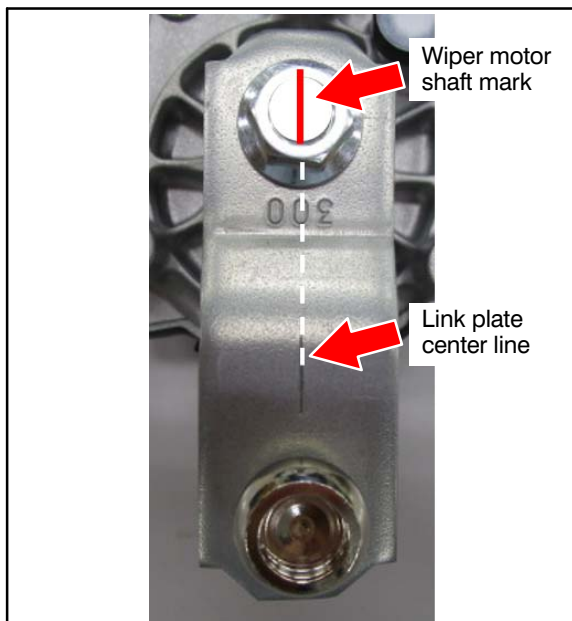

13. Use a straight edge to line up the link plate center line and the center of the wiper motor shaft, and use a marker to create a visible marking on the wiper motor shaft.

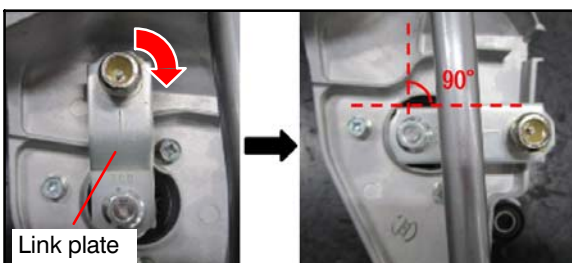

14. Turn the link plate approximately 90 degrees clockwise.



For vehicles with recall SR-16-010 open:

- a. Remove and discard old wiper motor.
- b. Obtain the new countermeasure wiper motor (part # 8250B137).
- c. Verify that the new wiper motor has a breathing hole cap with a water proof cloth, as shown.

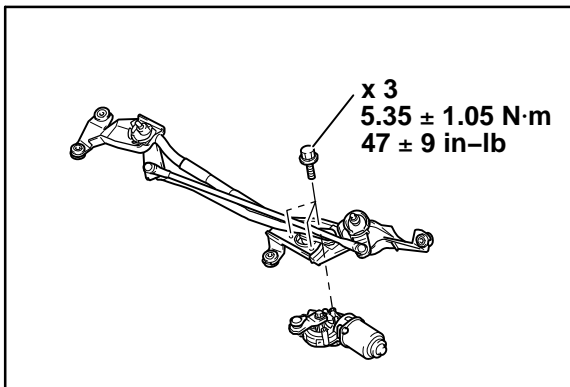

For vehicles with recall SR-16-010 open:

- d. Install the new wiper motor to the wiper link assembly as illustrated, and tighten the 3 bolts to 47 ± 9 in-lb (5.35 ± 1.05 Nm).

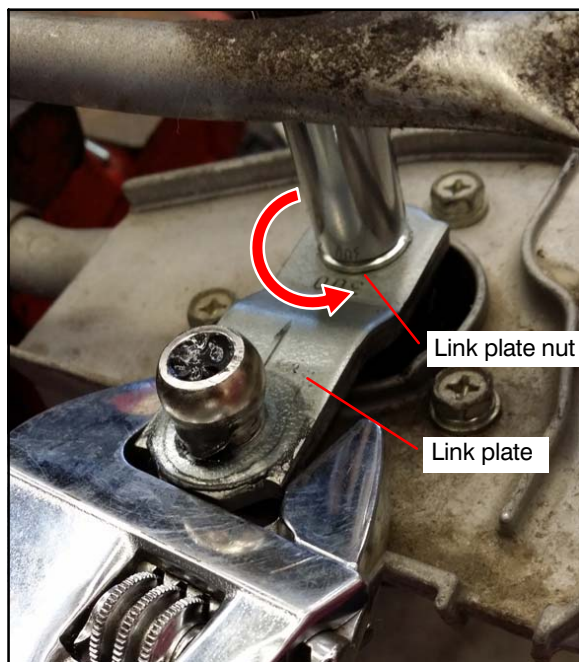

15. Hold the link plate in place with an adjustable wrench while loosening the link plate nut.

16. Remove the link plate and link plate nut.

NOTE: The link plate nut will be reused. Do not discard.



17. Check the knurling on the wiper motor shaft for any damage and/or debris. Clean off any debris with a clean rag.



CAUTION

Clamp the wiper link assembly at the connection pipe only.

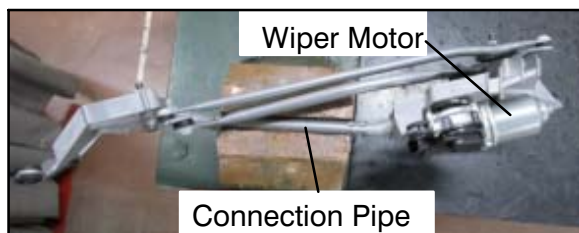

18. Rotate the wiper link assembly 90 degrees upward so that the wiper motor is directly visible from the top.

CAUTION: Clamp ONLY the connection pipe section.

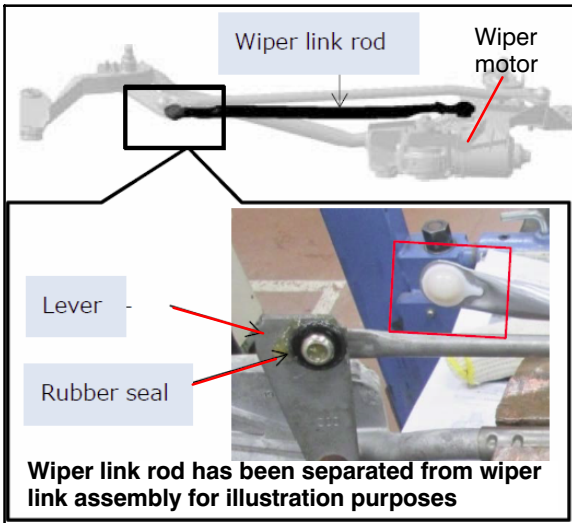

19. Locate the joint to be separated.



Do not remove the wiper motor side joint.



20. Pull back the rubber seal to prevent damage when performing the following steps.



21. Use bent needle nose pliers to separate the wiper link rod from the wiper link assembly.

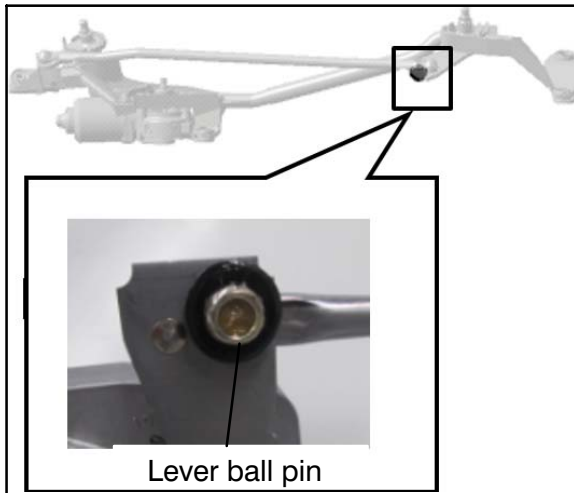

22. Use a rag to clean dirt and grease off of the lever ball pin and rubber seal.

⚠ CAUTION

Do NOT install link rod assembly if there is presence of water. If there is presence of water, remove excess water and dry thoroughly prior to re-installation.

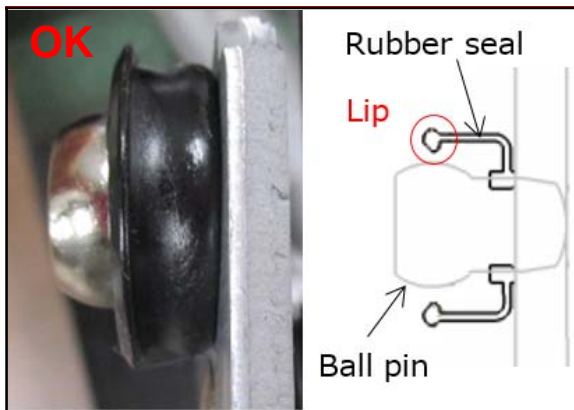

23. Verify that the rubber seal is not damaged. If rubber seal is damaged, replace it with a new rubber seal (part # 8251A098).

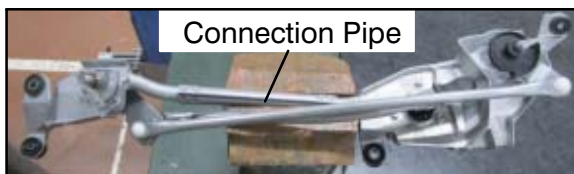

24. Rotate the wiper link assembly 90 degrees down so that the motor axle is facing up.

CAUTION: Clamp ONLY the connection pipe section.

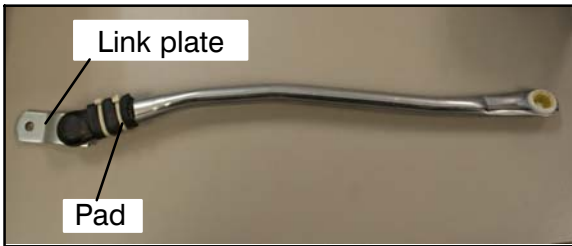

- 25. Obtain new wiper link rod (part # 8251A100).
- 26. Verify that the new wiper link rod appears as illustrated, complete with pad and link plate attached.



- 27. Install the wiper link plate to the wiper motor shaft. Make sure that the link plate and wiper link rod are in the correct orientation.

CAUTION Do NOT install link plate in a slanted position.

CAUTION Do NOT damage the pad.

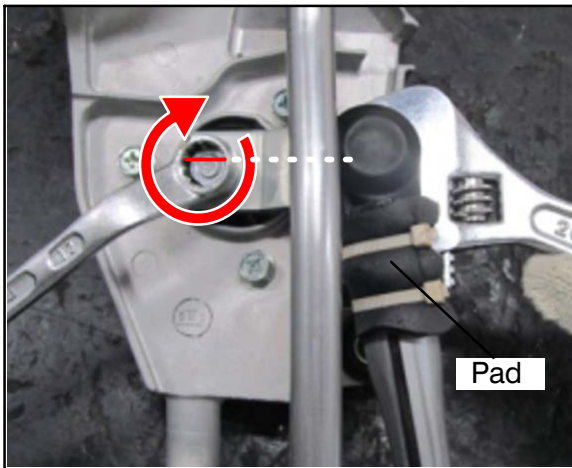

- 28. Make sure that the wiper motor shaft mark and the link plate center line are lined up. Use an adjustable wrench to hold the link plate in position, to prevent link plate rotation. Tighten the nut to 12.5 ft-lb \pm 1 ft-lb (17.2 \pm 1.0 Nm).

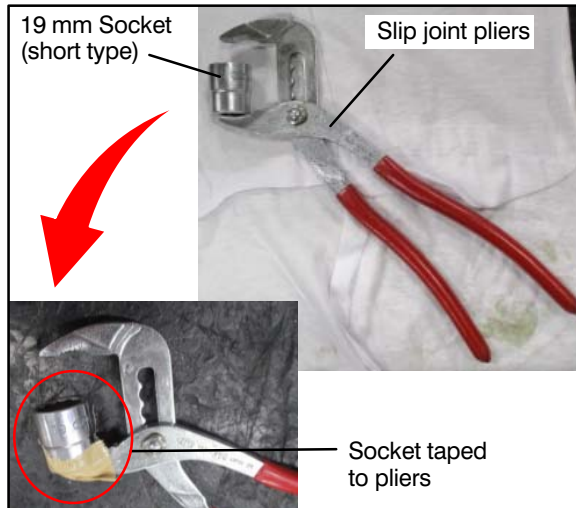

29. To prevent damage to the plastic case, improvise a tool using a 19 mm socket taped to slip joint pliers as shown.

CAUTION

Turn the link plate slowly to avoid internal damage to the wiper motor.

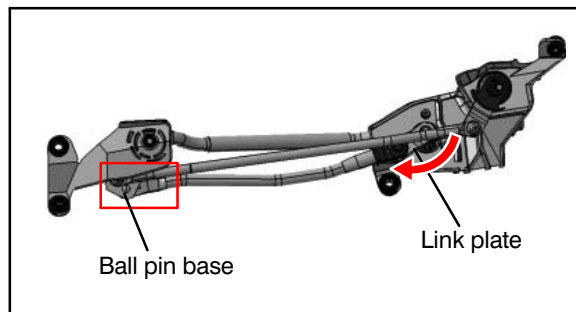

30. Turn the link plate slowly in the direction shown by the red arrow, so that the ball pin's base is visible (for easier installation).

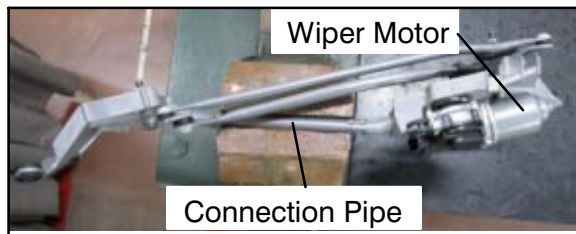

31. Rotate the wiper link assembly 90 degrees upward so that the wiper motor is directly visible from the top.
CAUTION: Clamp ONLY the connection pipe section.

32. Install wiper link rod, using the improvised tool, to the lever end that is opposing the wiper motor.



CAUTION

The rubber seal must be properly seated. Confirm good condition of the rubber seal.

33. Verify that the rubber seal is properly seated.

CAUTION

Confirm that the plastic case is not damaged or cracked.

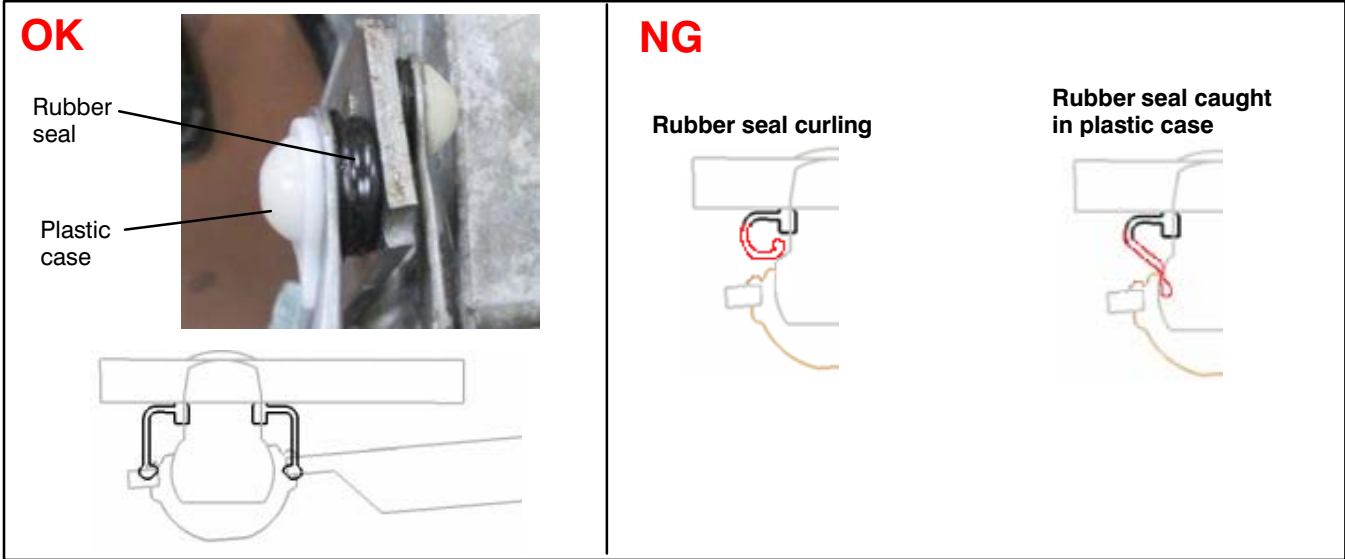

34. Remove the wiper link assembly from the vice.

35. Reinstall the wiper link assembly to the vehicle and connect the windshield wiper motor connector.

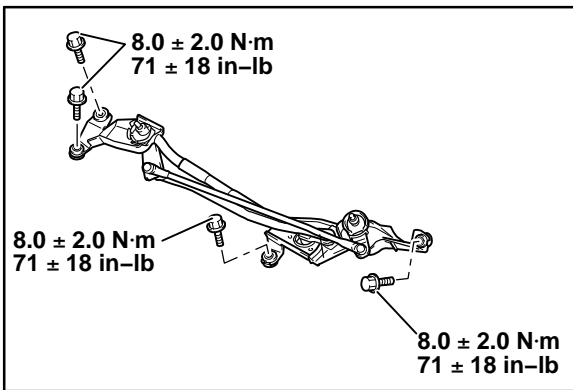
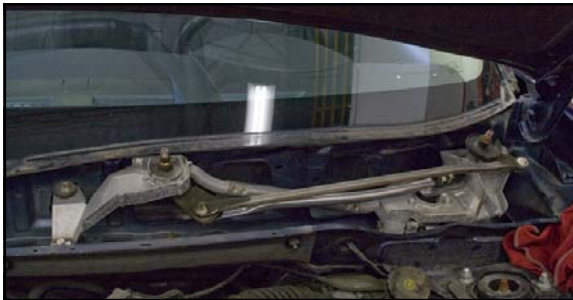

Torque bolts to $71 \pm 18 \text{ in}\cdot\text{lb}$ ($8.0 \pm 2.0 \text{ Nm}$).

WARNING

Do not allow any appendages, clothing, or other items to make contact with the wiper link assembly. The wiper may move once the wiper fuse is reinstalled, causing bodily injuries and/or damage to vehicle.

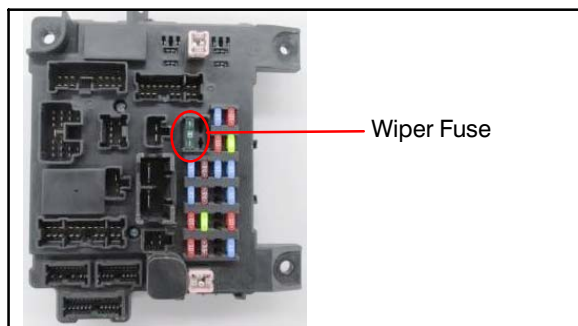

36. Reinstall the Wiper Fuse.

37. Turn the ignition switch to “ACC” or “ON”.

38. Switch the windshield wiper switch to “LO” and back to “OFF” to move wiper link to initial position.

39. Remove protective slit hose from windshield.



40. Install the passenger side wiper arm at the marked position.

a. Tighten nut to 20 ± 2 ft-lb (27 ± 3 Nm).

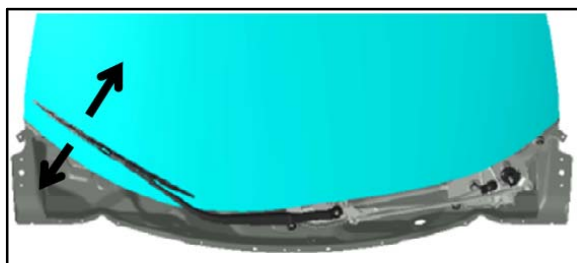

41. Confirm wiper operation in wiper “INT” mode for 10 cycles. If either of the following abnormal behavior is observed, perform the appropriate correction.

a. Abnormal behavior 1: Wiper blade moves up briefly then stops.

(1) Correction procedure: Turn link plate clockwise.

b. Abnormal behavior 2: Wiper blade moves down briefly during the start of wiper operation.

(1) Correction procedure: Turn link plate counterclockwise.

- 42. Remove the passenger side wiper arm.
- 43. Reinstall the front deck garnish.
- 44. Reinstall hood rear passenger side weatherstrip.
- 45. Reinstall the wiper arm blade assemblies to the marked locations.
- 46. Tighten nuts to 20 ± 2 ft-lb (27 ± 3 Nm).
- 47. Verify wiper motor operation by turning the vehicle ignition to “ACC” or “ON” and activate the windshield wipers in “LO” and “HI” positions.
- 48. Return the Fuse Remover to the fuse box.
- 49. Close the fuse box lid and hood.

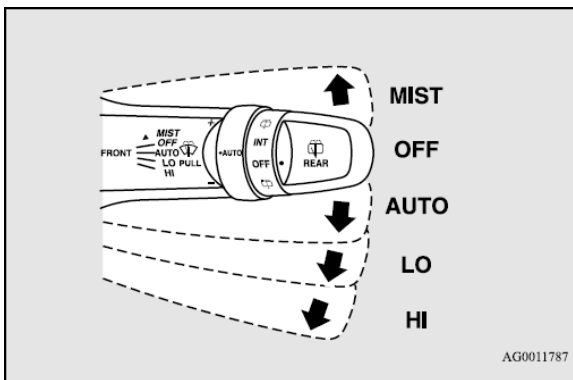

- 50. Reinstall the passenger compartment fuse lid by lining up the fuse lid hook (A) with the clamp (B) on the instrument panel and push the lid back in.

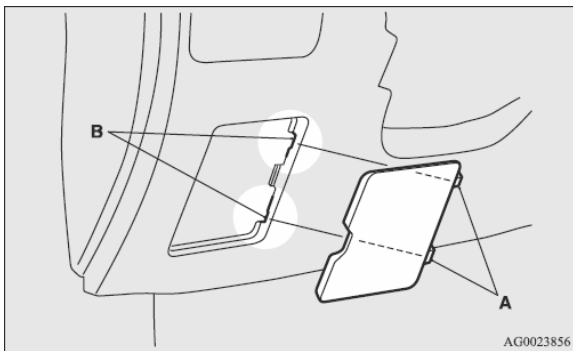

PARTS INFORMATION

Part Number	Part Description
8251A100	WIPER LINK ROD

WARRANTY INFORMATION

#	Repair Procedure	Model Years	Campaign Operation	Labor Time Allowance	Part Number
1	Wiper Link Rod Replacement	2013–2015	C1805Z01	0.7 hours	8251A100
2	Wiper Link Rod Replacement	2011–2012, 2016	C1806Z01	0.7 hours	8251A100

WARRANTY / RECALL CAMPAIGN CLAIM INFORMATION

Enter all claims as claim type 'C' – Recall/Campaign Claims.

Please follow the campaign instructions when entering each claim in order to select the applicable operation code that correctly matches up with the work that was actually performed. A claim example is provided below.

Certain 2011–2016 MY Outlander Sport / RVR models

Claim Header Section:

MITSUBISHI DEALER LINK Service Warranty Help

Claim Entry Vehicle Information Interface PQR/VQR

Campaign Information

Enter in the first 6 characters of the applicable campaign number: **C1805Z or C1806Z.**

This campaign is for replacing the wiper link.

Check the Open Campaign area of the Superscreen each time to be certain of a vehicle's eligibility. Only VINs showing **C1805Z or C1806Z** as open are involved.

Note: All vehicles with open C1611Z or C1612Z must be completed with this recall. The labor times for C1611Z and C1612Z have been adjusted to pay the correct amount of labor to perform the 2 recalls at the same time.

Campaign Operation No	C1805Z
Miles/Km	64500
VIN	JA.....
Service Technician	Emp N
Service Advisor	
Spec Value *	
Duplicate Recall *	<input type="checkbox"/>
Dealer: 99320	Ref No:
Claim No:	Adj:
VIN:	Claim Status: Incomplete
Model and Year:	

Save & Continue **Main Menu**

After entering the required customer data, vehicle information, select the applicable campaign number and the one replacement scenario performed. Then, by hitting the "Save and Continue" button, the system will automatically fill—in several fields. See the labor parts examples on the next page.

Labor and Parts

Labor: There is only 1 repair scenario for this campaign – Replace the wiper link.

Replace the wiper link: C1805Z01 or C1806Z01 .7 hrs.

Parts: The wiper link will be the required part for this recall.

Replace with part number: 8251A100 Rod, Assembly Wiper Link (LHD)

Campaign Claim

Follow the allowed labor time and required parts to be replaced depending on the one specific campaign operation that applies to the specific vehicle. The applicable campaign operation is shown on the Superscreen.

#	Repair Procedure	Model Years	Campaign Operation	Labor Time Allowance	Part Number
1	Wiper Link Rod Replacement	2013–2015	C1805Z01	0.7 hours	8251A100
2	Wiper Link Rod Replacement	2011–2012, 2016	C1806Z01	0.7 hours	8251A100

Rental Cars and/or Towing Charges:

If there is a need to provide the owner with a rental car, claim the applicable charges in this section of the claim on the lower portion of the labor entry screen.

Special Sublet Selection

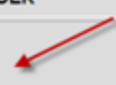
Select	Labor Operation	Labor Operation Description	
<input type="checkbox"/>	SHO	SPECIAL HANDLING ORDER	SHO Parts Order <input type="text"/>
<input type="checkbox"/>	RENTACAR	RENTAL CAR CHARGES 	Days <input type="text"/> Reason <input type="text" value="<Select one>"/> Rental Company <input type="text"/> Invoice Number <input type="text"/>
<input type="checkbox"/>	95300040	FREIGHT CHARGES	Freight Company <input type="text"/> Invoice Number <input type="text"/>
<input type="checkbox"/>	95200040	TOWING CHARGES	Towing Company <input type="text"/> Invoice Number <input type="text"/>