



David J. Johnson
Director
Service Engineering Operations
Ford Customer Service Division

Ford Motor Company
P. O. Box 1904
Dearborn, Michigan 48121

December 17, 2018

TO: All U.S. Ford and Lincoln Dealers

SUBJECT: **Safety Recall 18S01 – Supplement #9**
Certain 2009-2010 and 2013 Mustang, 2009-2010 Ranger, 2009-2010 Fusion and Milan, 2009-2010 MKZ, and 2009-2010 Edge and MKX Vehicles
Passenger Airbag Inflator Replacement

New! REASON FOR THIS SUPPLEMENT

- *The deadline for the long-term rental program has been extended to **December 24, 2018** to allow dealers to finalize and submit claims, and to repair the few remaining vehicles. Dealers should prioritize these customers' vehicles to ensure they are repaired by this date. Refer to the Rental Vehicles section and the Takata Airbag Recall Rental Vehicle Policy attachment for details.*
- *To allow dealers to be creative in their approach to completing Takata airbag recall repairs, technician time recording requirements, as specified in the Warranty & Policy Manual, **are not required for this recall**. Some examples of creative approaches to repairs include:*
 - *Mobile repairs*
 - *Sublet repairs to outside repair facilities (including body shops)*
 - *Utilizing other areas of the dealership such as new vehicle delivery, wash bays, parking lot, etc.*
 - *Utilizing multiple technicians in an assembly-line form of repair*

REMINDER: Previous passenger airbag modules with part numbers AE5Z-54044A74-C and AH6Z-54044A74-C, for 2010-11 Fusion, Milan, and MKZ are subject to a stop sale and must be returned. **Do not perform any repairs using these parts.**

- If an affected part was installed in a vehicle, submit a web contact to the Special Service Support Center (SSSC) under FSA 18S34 using contact type 'Non-Involved'. Include repair order documentation showing use of the part on the vehicle.

REASON FOR THIS SAFETY RECALL

NHTSA and Takata have determined that the propellant in certain Takata airbag inflators can experience an alteration over time with exposure to certain climate conditions. A combination of time, high temperature fluctuations, and humidity contribute to the degradation of the propellant in the inflators. This degradation can cause the propellant to burn too quickly, creating high pressure inside the inflator, and in extreme cases causing the inflator to rupture in the event of a crash necessitating airbag deployment. A ruptured inflator can send inflator parts toward vehicle occupants resulting in serious injury or death. Additional information regarding Takata recalls can be found at www.nhtsa.gov and www.safercar.gov.

SERVICE ACTION

Dealers are to replace the passenger airbag inflator or passenger airbag module as directed in the Technical Information attachments. This service must be performed on all affected vehicles at no charge to the vehicle owner.

For Mustang vehicles, dealers should check OASIS to determine if safety recall 15S21 is open for the driver side airbag. If safety recall 15S21 is open, then it must be completed in addition to safety recall 18S01. Parts are readily available to complete safety recall 15S21.

AFFECTED VEHICLES

Affected vehicles are identified in OASIS and FSA VIN Lists.

Vehicle	Model Year	Assembly Plant	Parts Availability
Mustang	2009-2010 & 2013	Flat Rock	✓ Available
Ranger	2009-2010	Twin Cities	✓ Available
Fusion/Milan	2009-2010	Hermosillo	✓ Available
MKZ/Zephyr	2009-2010	Hermosillo	✓ Available
Edge	2007-2010	Oakville	✓ Available
MKX	2007-2010	Oakville	✓ Available

OWNER NOTIFICATION MAILING SCHEDULE

Owner letters for Ranger, Mustang, Ford GT, and 2009 MKZ vehicles have been mailed. Edge and 2009 Fusion/Milan customers will be notified in 4 separate mailings starting the week of November 26, 2018. 2010 Fusion and Milan customers will be notified in 4 separate mailings starting the week of December 24, 2018. Dealers must repair any affected vehicles for which repairs are available, whether or not the customer has received a letter.

PLEASE NOTE:

Federal law requires dealers to complete this recall service before a new vehicle is delivered to the buyer or lessee. Violation of this requirement by a dealer could result in a civil penalty of up to \$21,000 per vehicle. Correct all vehicles in your new vehicle inventory before delivery.

New! ATTACHMENTS

<i>Attachment I:</i>	<i>Administrative Information</i>
Attachment II:	Labor Allowances and Parts Ordering Information
Attachment III:	Technical Information – 2009 Mustang
Attachment IV:	Technical Information – 2010 & 2013 Mustang
Attachment V:	Technical Information – 2009-2010 Ranger
Attachment VI:	Technical Information – 2009 MKZ
Attachment VII:	Technical Information – 2009 Fusion and Milan
Attachment VIII:	Technical Information – 2009-2010 Edge
Attachment IX:	Technical Information – 2010 Fusion and Milan
Attachment X:	Technical Information – 2010 MKZ
Attachment XI:	Technical Information – 2009-2010 MKX
Attachment XII:	Airbag Inflator Return Process – Parts with Core Charges
Attachment XIII:	Dealer Q & A

Attachment XIV: Takata Airbag Recall Rental Vehicle Policy

Owner Notification Letters

QUESTIONS & ASSISTANCE

For questions and assistance, contact the Special Service Support Center (SSSC) via the SSSC Web Contact Site. The SSSC Web Contact Site can be accessed through the Professional Technician Society (PTS) website using the SSSC link listed at the bottom of the OASIS VIN report screen or listed under the SSSC tab.

Sincerely,



David J. Johnson

Safety Recall 18S01 – Supplement #9

Certain 2009-2010 and 2013 Mustang, 2009-2010 Ranger, 2009-2010 Fusion and Milan, 2009-2010 MKZ, and 2009-2010 Edge and MKX Vehicles
Passenger Airbag Inflator Replacement

OASIS ACTIVATION

OASIS was activated on February 15, 2018.

FSA VIN LISTS ACTIVATION

FSA VIN Lists will be available through <https://web.fsavinlists.dealerconnection.com> on September 24, 2018 for vehicles that can be repaired at this time.

NOTE: Your FSA VIN Lists may contain owner names and addresses obtained from motor vehicle registration records. The use of such motor vehicle registration data for any purpose other than in connection with this recall is a violation of law in several states, provinces, and countries. Accordingly, you must limit the use of this listing to the follow-up necessary to complete this recall.

SOLD VEHICLES

- Owners of affected vehicles will be directed to dealers for this repair.
- Immediately contact any of your affected customers whose vehicles are not on your VIN list but are identified in OASIS. Give the customer a copy of the Owner Notification Letter (when available) and schedule a service date.
- Correct other affected vehicles identified in OASIS which are brought to your dealership.
- Dealers are to prioritize customer vehicles over used vehicle inventory.

STOCK VEHICLES

- Dealers should use OASIS to identify any affected vehicles in your used vehicle inventory and perform the repair.

USED CAR LOTS/OTHER FRANCHISES

Dealers are encouraged to establish ongoing contacts with local used car lots, non-Ford or Lincoln branded dealerships, independent repair facilities and vehicle auctions. Dealers should request that these businesses notify them if they have vehicles affected by a Takata airbag recall. If a dealer is notified of vehicles that have an open Takata airbag recall, repairs must promptly be made to these vehicles.

DEALER-OPERATED RENTAL VEHICLES

The Fixing America's Surface Transportation (FAST) Act law effective June 2016 prohibits a rental company from selling, renting or leasing vehicles subject to a safety or compliance recall. Please consult your legal counsel for legal advice.

TITLE BRANDED / SALVAGED VEHICLES

Affected title branded and salvaged vehicles are eligible for this recall.

QUICK LANE REPAIRS

- At the dealer's discretion, dealers with Quick Lanes may now use Quick Lane service bays and Quick Lane technicians to perform **Takata Airbag Recalls**.
- Claim processing, hazardous material handling and parts returns **MUST** be processed through the main dealership's warranty submission process and parts department.
- No other warranty or recall repairs are allowed at Quick Lanes at this time.

OWNER REFUNDS

Refunds are not approved for this program.

Safety Recall 18S01 – Supplement #9

Certain 2009-2010 and 2013 Mustang, 2009-2010 Ranger, 2009-2010 Fusion and Milan, 2009-2010 MKZ, and 2009-2010 Edge and MKX Vehicles
Passenger Airbag Inflator Replacement

New! RENTAL VEHICLES

Parts are now available to order for all vehicles. With proper dealer parts ordering and service appointment scheduling, rental vehicles should not be required to complete this recall repair. Due to increased parts availability, *effective **December 24, 2018**, no additional long-term rentals will be approved. Back-dated rental approvals will not be approved effective **December 17, 2018**.*

NOTE: For customers that have been in a long-term rental vehicle as of, or before, the dates listed in the table below, the recall repair on their recalled vehicle must be completed by **December 24, 2018**. Parts for these customers' recalled vehicles were shipped to dealers in November 2018.

Customer's Recalled Vehicle:	Customer in Rental As Of, or Before:
2006-2009 Fusion/Milan/MKZ/Zephyr	September 24, 2018
2007-2010 Edge/MKX	October 19, 2018
2010-2012 Fusion/Milan/MKZ	November 16, 2018

These customers' recalled vehicles must be dropped off at their servicing dealership by **December 10, 2018** for repairs. If their recalled vehicle is not dropped off by **December 10, 2018**, the customer will be responsible for rental expenses incurred from December 10, 2018 until the date the vehicle is dropped off at the dealership.

If unique circumstances require additional rental days beyond **December 24, 2018**, include details outlining why the additional days are required in the SSSC web contact.

NOTE: Dealers must notify the customer the same day that the repair is completed on their vehicle and request that they promptly return the rental vehicle. Once a customer is notified that their vehicle is repaired, they have up to 7 days to return their rental vehicle and pick up their repaired vehicle. Any rental expenses incurred beyond these 7 days will not be reimbursed.

EXAMPLE: Repair is completed on December 12, and customer is notified the same day. The rental reimbursement will not extend past December 19.

Short-term rentals will remain available if a customer requests a rental vehicle while their vehicle is being repaired. The short-term rental vehicle program is an effort to make it easier for customers to have this recall repair completed and should only be offered when a customer requests a rental vehicle. Rental vehicles must not be used to help manage service department scheduling.

If a customer requests a rental vehicle while their vehicle is being repaired, refer to the flow chart in the Takata Airbag Recall Rental Policy attachment for the process for requesting rental vehicle reimbursement. Dealers must:

- order required parts prior to a customer's appointment.
- retain customers' vehicles until the recall repair is completed and the rental vehicle is returned.
- notify the customer the same day that the repair is completed on their vehicle and request that they promptly return the rental vehicle. Rentals exceeding 7 days from the date the customer is notified that their vehicle is repaired, will not be reimbursed.

If the customer has paid for a rental vehicle or alternative transportation for the purpose of this recall, they are eligible for reimbursement within the guidelines outlined in the Takata Airbag Recall Rental Vehicle Policy. Dealers must follow the same process for claiming rental vehicle reimbursement and then refund the customer.

REMINDER: Short-term rentals exceeding 4 days and all long-term rentals **must be submitted to the SSSC at the start of each rental approval period**. Refer to the flow chart in the Takata Airbag Recall Rental Policy attachment for details. If a customer is currently in a rental vehicle and an approval code has not been received for the current timeframe, or any required future timeframe, approval must be submitted to the SSSC by **December 17, 2018**. No back-dated, long-term rentals will be approved on, or after, **December 17, 2018**.

Safety Recall 18S01 – Supplement #9

Certain 2009-2010 and 2013 Mustang, 2009-2010 Ranger, 2009-2010 Fusion and Milan, 2009-2010 MKZ, and 2009-2010 Edge and MKX Vehicles
Passenger Airbag Inflator Replacement

ADDITIONAL REPAIR (LABOR TIME AND/OR PARTS)

Additional repairs identified as necessary to complete the FSA should be managed as follows:

- Vehicles that have deployed, missing, or modified airbags need to be reviewed by the Special Service Support Center (SSSC) to ensure the potential risk for airbag inflator rupture is no longer present. Dealers should submit a VIN-specific web contact request to the SSSC with pictures showing the airbag's state and vehicle's VIN plate so a determination can be made.
- For related damage and access time requirements, refer to the Warranty and Policy Manual – Section 6 – Ford/Lincoln Program Policies – Field Service Actions (FSA) – Related Damage.
- Submit an Approval Request to the SSSC Web Contact Site prior to completing the repair.

CLAIMS PREPARATION AND SUBMISSION

- Enter claims using Dealer Management System (DMS) or One Warranty Solution (OWS) online.
 - Select claim type 31: Field Service Action. The FSA number (18S01) is the sub code.
 - For additional claims preparation and submission information, refer to the Recall and Customer Satisfaction Program (CSP) Repairs in the OWS User Guide.
- Additional labor and/or parts must be claimed as related damage on a separate repair line from the FSA. **IMPORTANT:** Click the radio button on the Related Damage Indicator.

NOTE: The serial number of the new passenger airbag inflator or module must be provided to Ford for the claim to be processed. The Technical Information in this bulletin advises technicians to document the serial number from the new airbag inflator on the repair order. The passenger airbag inflator serial number is 11 characters for Ranger, Mustang, and GT and 13 characters for Edge, MKZ/Zephyr, Fusion, Milan, and MKX. If the serial number is not readable, a new inflator/module must be installed. Enter the serial number of the new airbag inflator or module in the claim as follows:

- For claims submitted using DMS or OWS on-line, enter the serial numbers in the Test Results Section.
 - Select DTC REQUIRED MEASUREMENT OR RESULTS from the drop down list.
 - Enter the serial number in the CODE field.
 - The serial number must be entered without spaces or dashes.

Sublet Repairs - Refer to the Warranty & Policy Manual for details on sublet invoice requirements.

NOTE: Claim processing, hazardous material handling, and parts returns for sublet repairs must be processed through the dealership's warranty submission process and parts department. Labor operations published in this bulletin should be claimed, not an OSL labor operation.

Safety Recall 18S01 – Supplement #9

Certain 2009-2010 and 2013 Mustang, 2009-2010 Ranger, 2009-2010 Fusion and Milan, 2009-2010 MKZ, and 2009-2010 Edge and MKX Vehicles
Passenger Airbag Inflator Replacement

New! RENTAL VEHICLE REIMBURSEMENT – CLAIMING INSTRUCTIONS

Refer to the Takata Airbag Recall Rental Vehicle Policy attachment for dollar amounts and further reimbursement details.

NOTE: Due to increased parts availability, effective **December 24, 2018**, no additional long-term rentals will be approved, Back-dated rental approvals will not be approved effective **December 17, 2018**. Refer to the Rental Vehicles section of this Dealer Bulletin for details.

Rental Claiming Reference Table*

Rental Term	FSA	Miscellaneous Expense Codes	Claiming Notes
Short-Term	18S01	“RENTAL” for rental expense	Claim all eligible rental expenses and admin fee on the same RO line as the repair. Rental periods greater than 4 days require SSSC approval code.
		“FSAEXP” for \$25 admin fee	
Long-Term	18A03	“RENTAL” for rental expense	Claim all eligible rental expenses and \$25 admin fee on separate 18A03 RO lines. Requires SSSC approval code.
		“FSAEXP” for \$25 admin fee	

* Refer to the information below (continued on the following page) for full rental vehicle claiming instructions.

Short-Term Rental Vehicle Reimbursement

Applicable if parts are listed as '**Available**' in the Dealer Bulletin and a customer requests a rental while the repair is being performed.

- Rental expenses must be claimed under FSA 18S01 on the same claim, and same RO line, as the repair.
- **ATTENTION: Rental claims must not be submitted against 18S01 on a separate claim or RO line from the repair. If this occurs the FSA on that VIN can close erroneously and cause further warranty claiming concerns.**
- Dealers are pre-approved for up to 4 days of rental reimbursement.
 - **If the rental period does not exceed 4 days**, submit the rental expense on the same claim and RO line as the repair. Use Misc. Expense Code “RENTAL”. No approval code is needed.
 - **If the rental period exceeds 4 days**, a web contact must be submitted to the Special Service Support Center (SSSC) for approval. Include details outlining why additional rental days are required.
 - The SSSC web contact must include all rental expenses, admin fee (if applicable), parts costs, and labor costs. All of these amounts are required so the approval code will cover the entire RO line amount.
 - Enter the total amount of the rental expenses on the same claim, and same RO line, as the repair. Use Misc. Expense Code “RENTAL”.
 - A \$25 administrative fee can be claimed on any short-term rental claims that exceed 4 days of rental and have an RO date after September 23, 2018. Claim the administrative fee on the same RO line under Misc. Expense Code “FSAEXP”. The \$25 must be included in the SSSC approval amount.

Only actual rental expenses incurred should be claimed, regardless of approval. OWS will accept claims up to the approved RO line amount; SSSC contacts do not need to be updated to decrease approval amounts.

Safety Recall 18S01 – Supplement #9

Certain 2009-2010 and 2013 Mustang, 2009-2010 Ranger, 2009-2010 Fusion and Milan, 2009-2010 MKZ, and 2009-2010 Edge and MKX Vehicles
Passenger Airbag Inflator Replacement

New! RENTAL VEHICLE REIMBURSEMENT – CLAIMING INSTRUCTIONS (continued)**Long-Term Rental Vehicle Reimbursement**

NOTE: Due to increased parts availability, effective **December 24, 2018**, no additional long-term rentals will be approved, Back-dated rental approvals will not be approved effective **December 17, 2018**. Refer to the Rental Vehicles section of this Dealer Bulletin for details.

Applicable if parts are listed as '**Limited**' or '**Not Available**' in the Dealer Bulletin and a customer requests a rental while waiting on parts.

- Rental expenses must be claimed under long-term rental program number 18A03. Enter the total amount of the rental expense under Misc. Expense Code "RENTAL".
NOTE: If a rental approval code has already been provided under FSA 18S01, that approval code can be submitted under 18A03 in OWS without updating the SSSC contact. If a 18S01 approval code being submitted under 18A03 also included parts, labor, etc., only claim the rental expense under 18A03.
- *Because long-term rentals end **December 24, 2018**, when submitting SSSC web contacts dealers should only request the actual rental days required.*
- For easier warranty claiming and rental invoicing, SSSC contacts can be updated to add additional days to a current approval code.
 - EXAMPLE: If approved for 14 days and 10 more are required, update the SSSC contact to request the 10 additional days on the same approval code/RO line. The approval code will now include a total of 28 days. If further days are required, the request can be updated again.
- Rental agency invoices do not need to match the individual rental warranty claims submitted.
 - EXAMPLE: Dealer has two rental approval codes for 14 days for the same VIN. A rental claim will need to be submitted for each prior approval code but a single rental invoice of 28 days will suffice.
 - The total number of rental days paid, across all the rental claims submitted for this program on a VIN, will be compared against the total number of days included on the invoice(s).
- Dealers are eligible to claim a \$25 administrative fee for any long-term rental claims that are submitted after June 13, 2018. This includes claims that were originally approved by the SSSC after May 12, 2018 but processed for warranty payment after June 13, 2018. Claim the administrative fee on a separate RO line under Misc. Expense Code "FSAEXP".

Only actual rental expenses incurred should be claimed even if approved for additional rental days. OWS will accept claims up to the approved RO line amount; SSSC contacts do not need to be updated to decrease approval amounts.

Safety Recall 18S01 – Supplement #9

Certain 2009-2010 and 2013 Mustang, 2009-2010 Ranger, 2009-2010 Fusion and Milan, 2009-2010 MKZ, and 2009-2010 Edge and MKX Vehicles
Passenger Airbag Inflator Replacement

LABOR ALLOWANCES (only vehicles that repairs are currently available for are listed)

Description	Labor Operation	Labor Time
Replace Passenger Airbag Inflator – 2009-2010 & 2013 Mustang	18S01B	0.5 Hours
Replace Passenger Airbag Inflator – 2009-2010 Ranger	18S01C	0.5 Hours
Replace Passenger Airbag Module – 2009 MKZ	18S01D	0.5 Hours
Replace Passenger Airbag Module – 2009 Fusion/Milan	18S01E	0.4 Hours
Replace Passenger Airbag Module – 2009-2010 Edge	18S01F	0.4 Hours
Replace Passenger Airbag Module – 2010 Fusion/Milan	18S01G	2.8 Hours
Replace Passenger Airbag Module – 2010 MKZ	18S01L	2.9 Hours*
Replace Passenger Airbag Module – 2009-2010 MKX	18S01J	0.7 Hours

* Previous 2010 MKZ technical instructions included steps for an airbag cushion sheet installation. 2010 MKZ vehicles do not require an airbag cushion sheet.

PARTS AVAILABILITY MATRIX

NOTE: The airbag inflators for Mustang and Ranger vehicles are shipped directly from the supplier rather than from a Ford parts warehouse. **PARTS ARE AVAILABLE FOR ORDERING even though parts warehouses will not show any inventory.**

Vehicle	Model Years	Parts Availability	Seed Stock
Mustang	2009-2010 & 2013	Available on open order	2 nd seed stock in Nov. 2018
Ranger	2009-2010	Available on open order	Seed stock completed
Fusion/Milan	2009-2010	Available through the SSSC	TBD
MKZ	2009-2010	Available through the SSSC	TBD
Edge	2009-2010	Available through the SSSC	TBD
MKX	2009-2010	Available through the SSSC	TBD

Refer to the Parts Requirements and Parts Ordering Information sections on the following pages for specific part numbers and ordering information by vehicle and model year.

Safety Recall 18S01 – Supplement #9

Certain 2009-2010 and 2013 Mustang, 2009-2010 Ranger, 2009-2010 Fusion and Milan, 2009-2010 MKZ, and 2009-2010 Edge and MKX Vehicles
Passenger Airbag Inflator Replacement

PARTS REQUIREMENTS

Instructions on how to order each specific part number are listed on page 4 of this attachment.

NOTE: The parts used in this safety recall may physically appear to be identical, but they have differing operating characteristics. **It is crucial that parts are NOT interchanged or substituted.**

The DOR/COR number for this recall is 51115.

2009-2010 and 2013 Mustang

Part Number	Description	Interior Color(s)	Component Color	Order Quantity	Claim Quantity
5R3Z-63044A74-B	Passenger Airbag Inflator – 2009 Mustang Only	-	-	1	1
6G7Z-63044A74-A	Passenger Airbag Inflator – 2010 & 2013 Mustang Only	-	-	1	1

2009-2010 Ranger

Part Number	Description	Interior Color(s)	Component Color	Order Quantity	Claim Quantity
8L5Z-10044A74-E	Passenger Airbag Inflator	-	-	1	1

2009 MKZ/Zephyr

Part Number	Description	Interior Color(s)	Component Color	Order Quantity	Claim Quantity
7H6Z-54044A74-AD	Passenger Airbag Module	Light Stone	Light Stone	1	1
7H6Z-54044A74-AE	Passenger Airbag Module	Charcoal Black	Charcoal Black	1	1
7H6Z-54044A74-AF	Passenger Airbag Module	Sand	Sand	1	1

2009 Fusion/Milan

Part Number	Description	Interior Color(s)	Component Color	Order Quantity	Claim Quantity
8E5Z-54044A74-AC	Passenger Airbag Module	Camel	Dark Stone	1	1
8E5Z-54044A74-AD	Passenger Airbag Module	Charcoal Black or Light Stone	Charcoal Black	1	1

Parts Requirements are continued on the following page.

Safety Recall 18S01 – Supplement #9

Certain 2009-2010 and 2013 Mustang, 2009-2010 Ranger, 2009-2010 Fusion and Milan, 2009-2010 MKZ, and 2009-2010 Edge and MKX Vehicles
Passenger Airbag Inflator Replacement

PARTS REQUIREMENTS (continued)

Instructions on how to order each specific part number are listed on page 4 of this attachment.

2009-2010 Edge

Part Number	Description	Interior Color(s)	Component Color	Order Quantity	Claim Quantity
9T4Z-78044A74-AA	Passenger Airbag Module	Charcoal Black or Camel	Charcoal Black	1	1
9T4Z-78044A74-AB	Passenger Airbag Module	Medium Light Stone	Greystone	1	1

2010 Fusion/Milan

Part Number	Description	Interior Color(s)	Component Color	Order Quantity	Claim Quantity
AE5Z-54044A74-D	Passenger Airbag Module	-	-	1	1
W711044-S403 <u>or</u> W711044-S439	A-Pillar Trim Clip	-	-	1	2
W712961-S439	Steering Column Shaft-to-Steering Gear Bolt	-	-	1	1
AE5Z-7804500-A	Airbag Cushion Sheet	-	-	Only if required	

2010 MKZ

Part Number	Description	Interior Color(s)	Component Color	Order Quantity	Claim Quantity
AH6Z-54044A74-D	Passenger Airbag Module	-	-	1	1
W711044-S403 <u>or</u> W711044-S439	A-Pillar Trim Clip	-	-	1	2
W712961-S439	Steering Column Shaft-to-Steering Gear Bolt	-	-	1	1

2009-2010 MKX

Part Number	Description	Interior Color(s)	Component Color	Order Quantity	Claim Quantity
9A1Z-78044A74-A	Passenger Airbag Module	-	-	1	1

DEALER PRICE

For latest prices, refer to DOES II.

Safety Recall 18S01 – Supplement #9

Certain 2009-2010 and 2013 Mustang, 2009-2010 Ranger, 2009-2010 Fusion and Milan, 2009-2010 MKZ, and 2009-2010 Edge and MKX Vehicles
Passenger Airbag Inflator Replacement

PARTS ORDERING INFORMATION

Due to the varying levels of part inventories, the parts ordering procedure and the distribution strategy for this recall will vary by part number and vehicle line. Refer to the vehicle lines listed below for the part ordering procedure and distribution strategy. Once sufficient parts inventory is available, parts strategy will move to open ordering. Dealers will be notified via a DOES II communication if circumstances warrant a change in part supply strategy and when open ordering begins.

NOTE: Because some parts used in this recall being shipped directly from the supplier, inventory that is readily available for ordering may not show available in dealer part ordering interfaces.

Fusion, Milan, MKZ, Edge, and MKX

To place an order, submit a VIN-specific Part Order contact via the SSSC Web Contact Site.

Mustang and Ranger

Due to the large volume of affected Mustang vehicles that still have an open recall, dealers will receive a second seed stock of Mustang parts starting in the month of November 2018 to ensure parts are readily available to complete repairs. If additional parts are required, order your parts through normal order processing channels.

To guarantee the shortest delivery time, an emergency order for parts must be placed. The emergency order surcharge can be waived on Ford Motor Company-paid repairs; see section 2500 of the Dealer Parts Policy & Procedure Manual on FMCDealer for details on order submission requirements.

Due to the significant number of vehicles requiring repair dealers are encouraged to maintain stock of FSA parts to be prepared to repair vehicles as they arrive for repairs. To ensure that parts are readily available at dealers to repair the millions of Ford and Lincoln vehicles affected by the Takata airbag recalls, dealers may receive seed stocks of additional parts.

EXCESS STOCK RETURN

To support NHTSA-assigned completion mandates for the Takata airbag recalls, and the millions of Ford and Lincoln vehicles that require repairs under the Takata airbag recalls, excess stock returns will not be accepted for unused new recall remedy parts until 85% of all affected vehicles have been repaired. Dealers should utilize their FSA VIN list and DMS information to contact their affected customers and repair all vehicles that are brought to your dealership with an open Takata airbag recall.

PARTS RETENTION AND RETURN

It is critical that all original passenger airbag inflators removed from vehicles are not allowed back into the market. Therefore, all passenger airbag inflators under this safety recall have been assigned a \$100 core charge to ensure they will be properly returned.

The Regional Core Recover Center (RCRC), **including dealers in Alaska and Hawaii**, will pick up these airbag inflators along with all other core returns during your normal core retrieval visit.

For details, refer to attachment: Regional Core Recovery Center - Airbag Inflator Return Process

IMPORTANT: Any new, unused stock of part numbers AE5Z-54044A74-C or AH6Z-54044A74-C (previously utilized under FSAs 16S26, 17S01, and 18S01) must no longer be installed in vehicles, and must be returned following the instructions in EFC06992, published October 18, 2018 on FMCDealer.

CERTAIN 2009 MUSTANG VEHICLES — PASSENGER AIRBAG INFLATOR REPLACEMENT

OVERVIEW

NHTSA and Takata have determined that the propellant in certain Takata airbag inflators can experience an alteration over time with exposure to certain climate conditions. A combination of time, high temperature fluctuations, and humidity contribute to the degradation of the propellant in the inflators. This degradation can cause the propellant to burn too quickly, creating high pressure inside the inflator, and in extreme cases causing the inflator to rupture in the event of a crash necessitating airbag deployment. A ruptured inflator can send inflator parts toward vehicle occupants resulting in serious injury or death.

Dealers are to replace the passenger airbag inflator. The serial number from the new airbag inflator must be recorded on the repair order. Place the replaced inflator into the packaging from the new part and provide to the appropriate dealership personnel for part returns.

NOTE: For vehicles that the airbags have deployed or that have other modifications preventing the recall repair from being completed, submit a VIN specific request to the SSSC Web Contact Site prior to attempting a repair. Attach pictures of the vehicles airbag modules to the request.

SERVICE PROCEDURE

Recommended Tools:

1/4" Drive Deep Socket - 7mm
1/4" Drive Ratchet
1/4" Drive Extension - 6" (152mm)
1/4" Drive Shallow Socket - 8mm
1/4" Drive Impact Driver
1/4" Drive Torque Wrench
Side Cutters
Utility Knife
Needle Nose Pliers
Pocket Screwdriver



AIRBAG INFLATOR REPLACEMENT

NOTE: The following repair instructions only apply to 2009 Mustang vehicles. Repair instructions will be published in separate attachments for the other vehicle lines included in this recall as parts become available for those vehicles.

NOTE: The parts used in this safety recall may physically appear to be identical, but they have differing operating characteristics. It is crucial that parts are not interchanged or substituted.

 **WARNING:** Failure to follow the instructions and warnings in the Workshop Manual (WSM) may result in injury.

NOTE: If the Airbag Readiness light indicates no Supplemental Restraint System (SRS) faults are present, it is not necessary to follow the WSM SRS Depowering and Repowering steps. Turn the ignition to OFF and wait 1 minute, then it is safe to proceed with airbag inflator replacement.

NOTE: The ignition must remain OFF until this service procedure is completed.

NOTE: To view a video demonstration of this repair procedure, click the video icon. 



1. Remove the passenger airbag from the vehicle. Please follow the WSM procedures in Section 501-20B.
2. Set the airbag face down onto a surface that will not scratch or damage the airbag face.
3. Remove the wiring harness connector retainer from the passenger airbag assembly. See Figure 1.

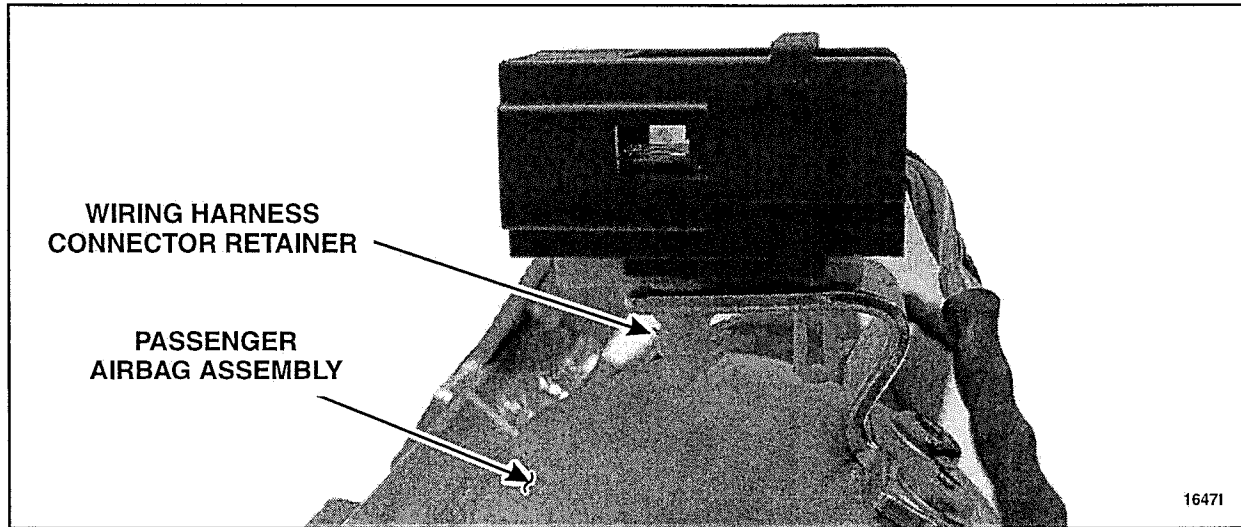

FIGURE 1

NOTE: Carry out this step on the longer wire on the end opposite of the airbag inflator retaining bracket. See Figure 2.

4. Remove approximately 100 mm (3.93 in) of the conduit from the passenger airbag assembly wire harness. See Figure 2.

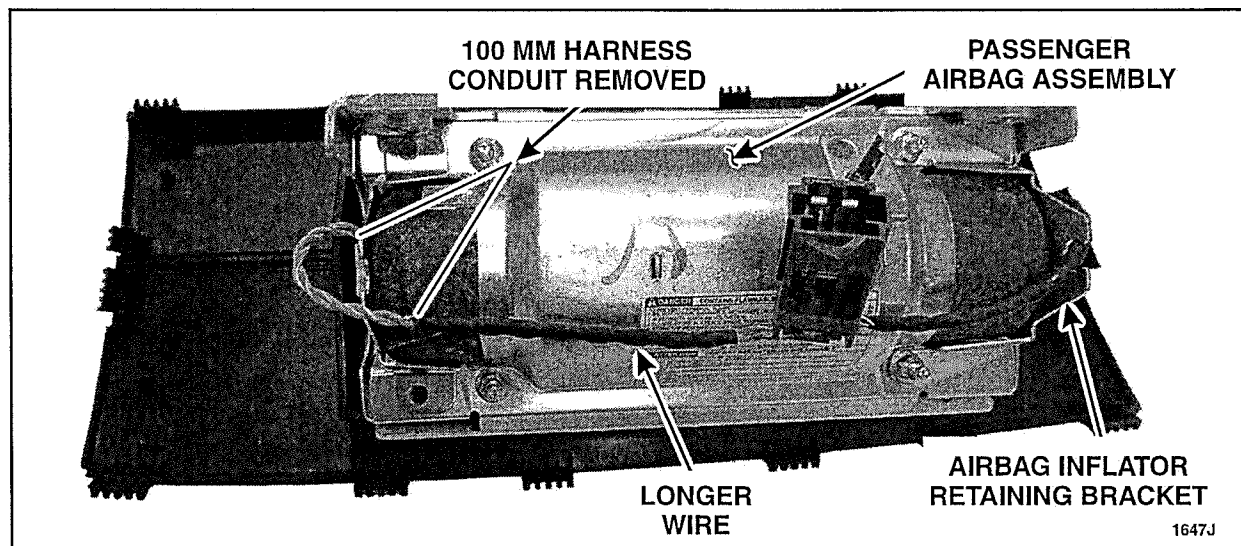

FIGURE 2



5. Position the shorting clip onto the harness wires, and crimp the shorting clip together one side at a time using pliers. See Figure 3.

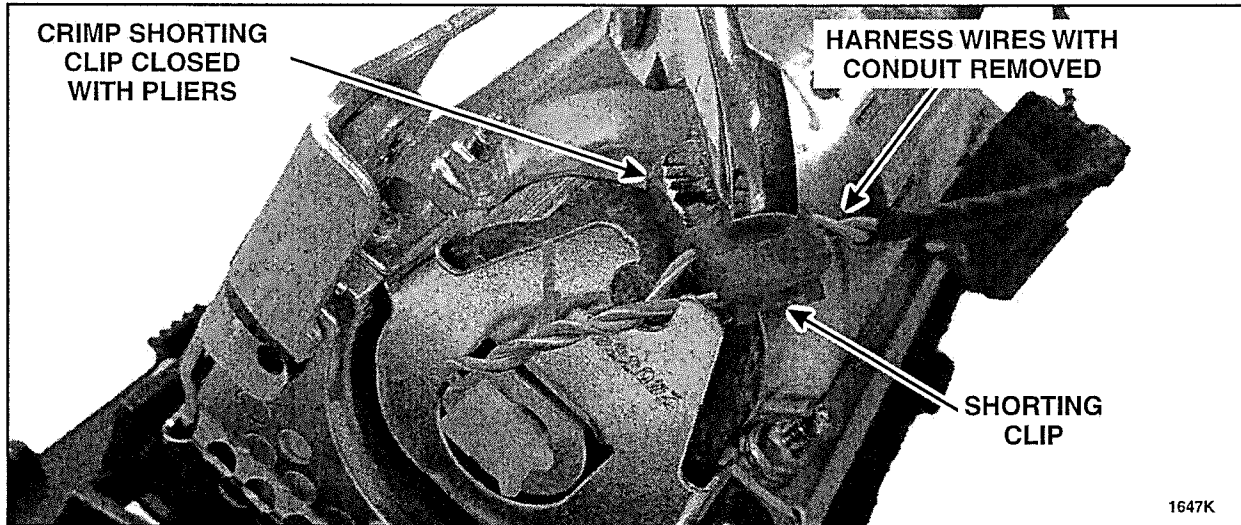

FIGURE 3

6. Cut the harness wires between the shorting clip and the harness connector. See Figure 4.

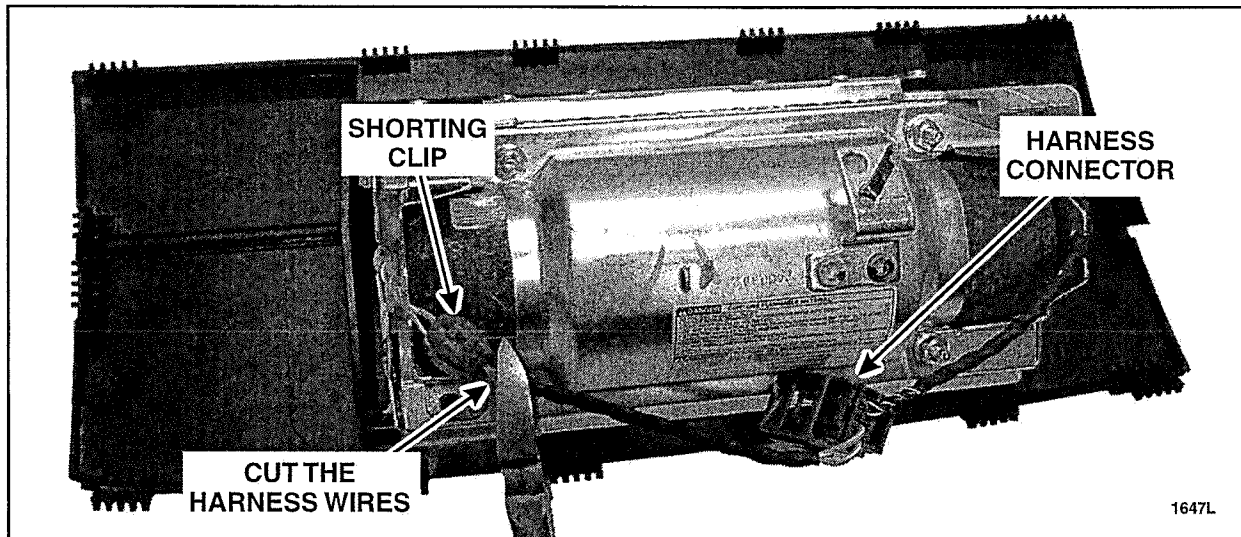

FIGURE 4



7. Remove and discard the four passenger airbag inflator retaining bracket nuts and the retaining bracket. See Figure 5.

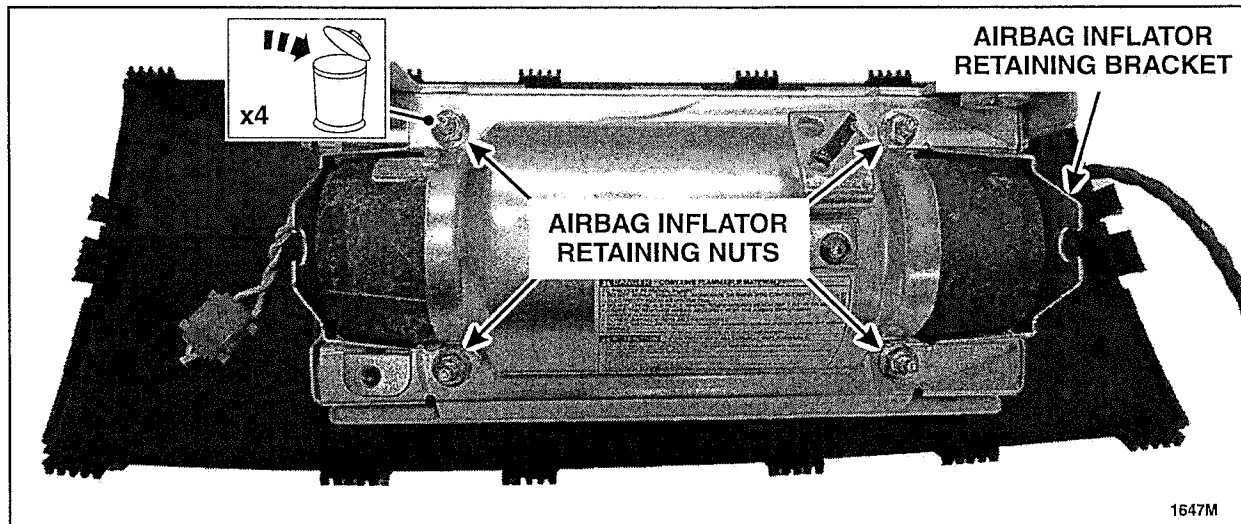

FIGURE 5

⚠ WARNING: Do not allow any debris on or around the airbag once the inflator is removed.

8. With an assistant holding the passenger airbag assembly, remove the inflator from the assembly by pushing outward on the inflator. Set the airbag inflator aside for return shipping. See Figure 6.

- If required, use of a brass punch is permitted (only at the location shown) to free the inflator from its mounted position.

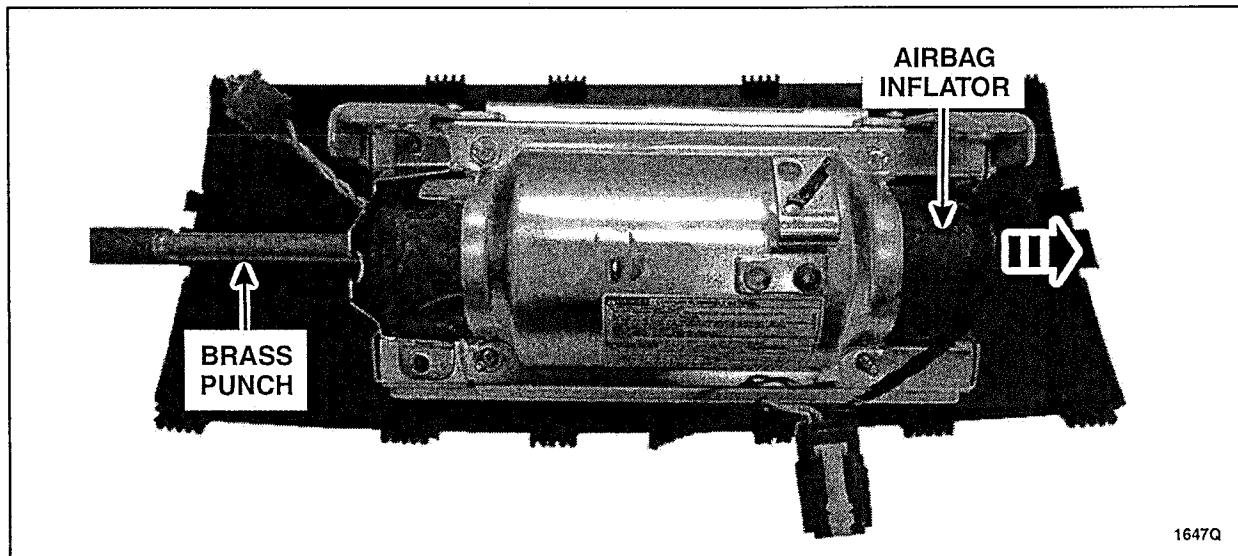

FIGURE 6



NOTE: The serial number of the new airbag inflator must be provided to Ford for the warranty claim to be processed.

9. Record the 11 character serial number of the *new* airbag inflator on the repair order. See Figure 7.

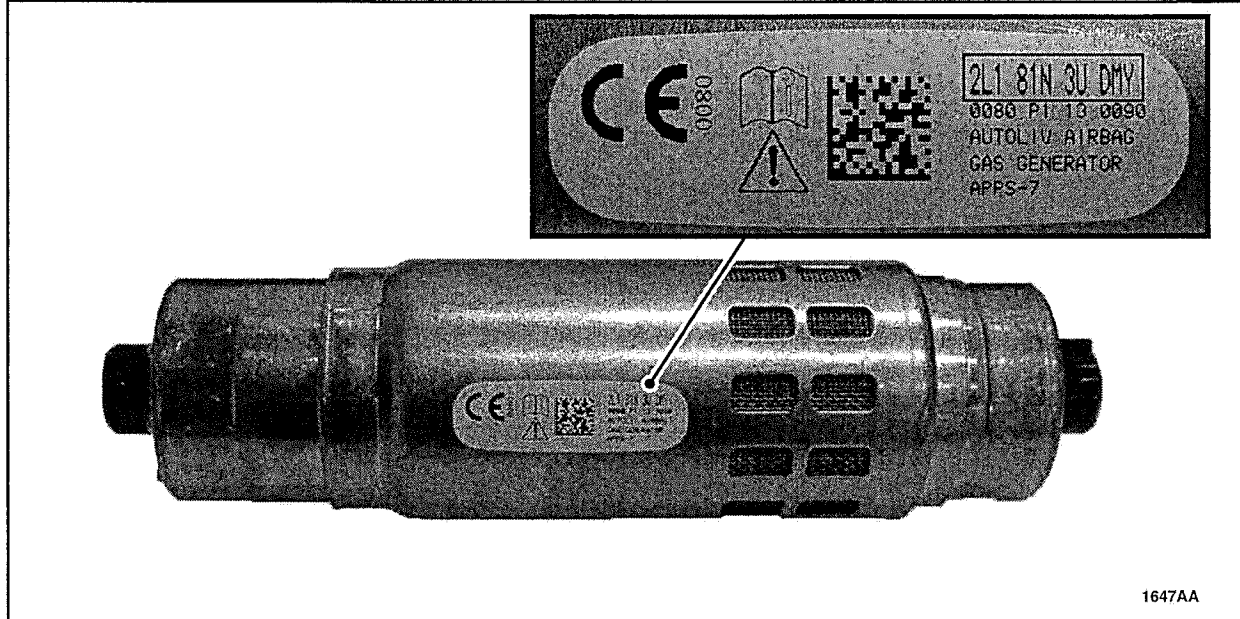

FIGURE 7



10. **NOTE:** Both *new* inflator end caps are specific to their respective end of the inflator and must be fully seated.

NOTE: The tail end cap does not have an alignment tab and may be installed in any orientation. Make sure the tail end cap is fully seated or you will not be able to install the inflator retaining bracket.

Install both *new* inflator end caps making sure the alignment feature on the cap nearest the inflator retaining bracket is properly oriented. See Figure 8.

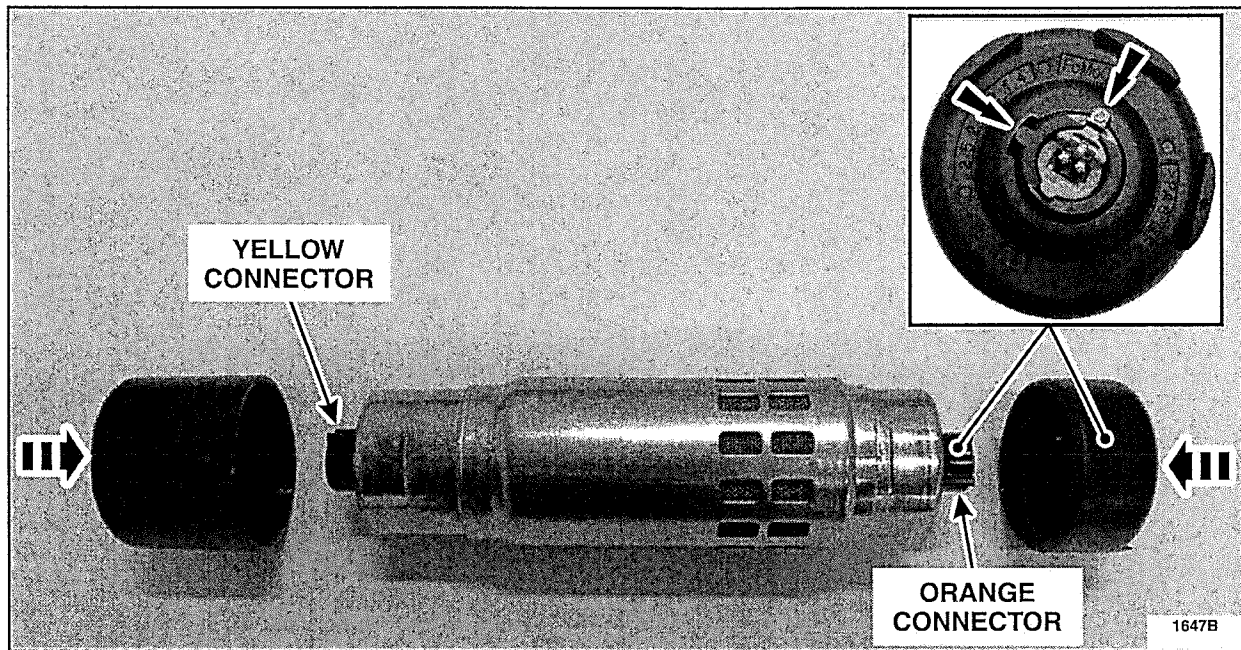

FIGURE 8

11. Install the inflator into the passenger airbag assembly with the orange connector end facing out. Align the three tabs on the cap nearest the inflator retaining bracket with the airbag module lower channel (facing down). See Figure 9.

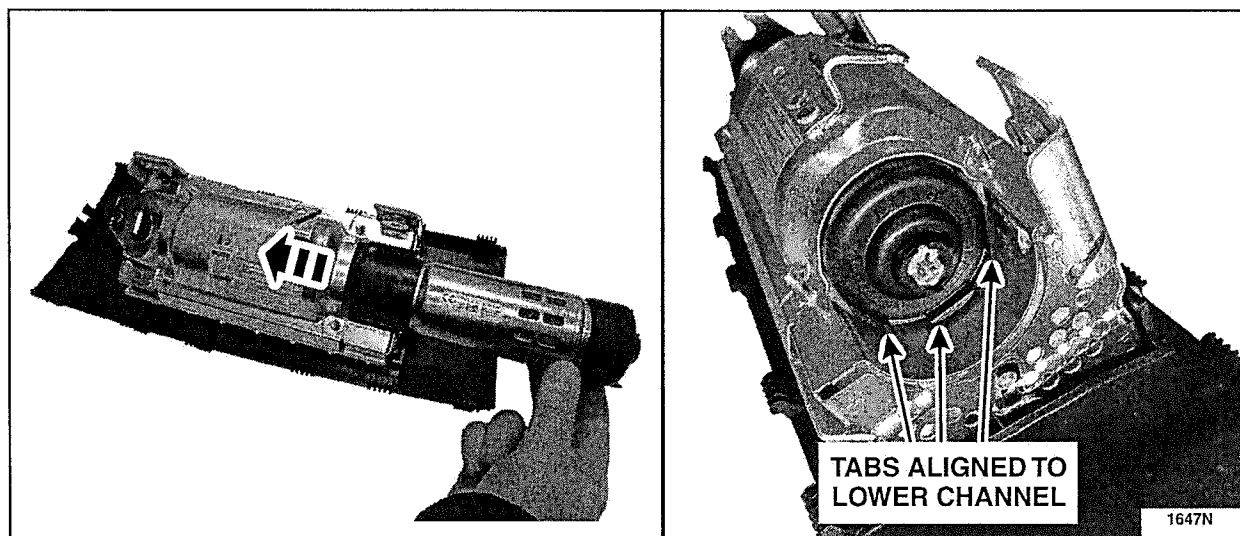

FIGURE 9



NOTE: If the inflator retaining bracket is unable to be installed, ensure the inflator tail end cap is fully seated.

12. Install the *new* passenger airbag inflator retaining bracket and *new* nuts. See Figure 10.

- Torque the new retaining nuts in the sequence shown below to 4 Nm (35 lb-in).

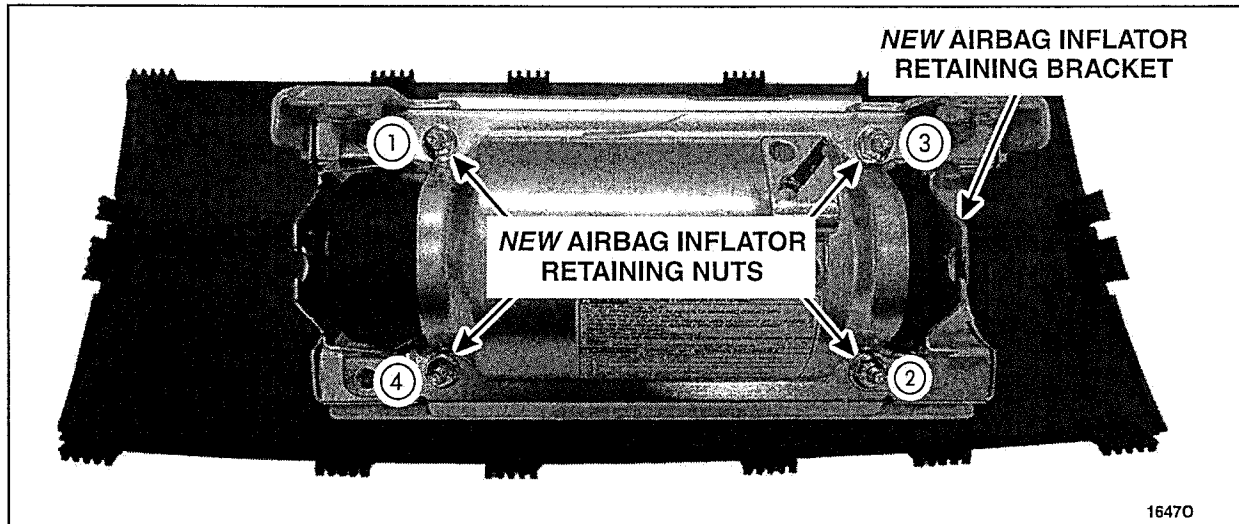

FIGURE 10

13. Align the T-shape index on both the wiring harness electrical connector and the airbag inflator. Install the new wiring harness onto the passenger airbag module and connect to both sides of the inflator. See Figure 11.

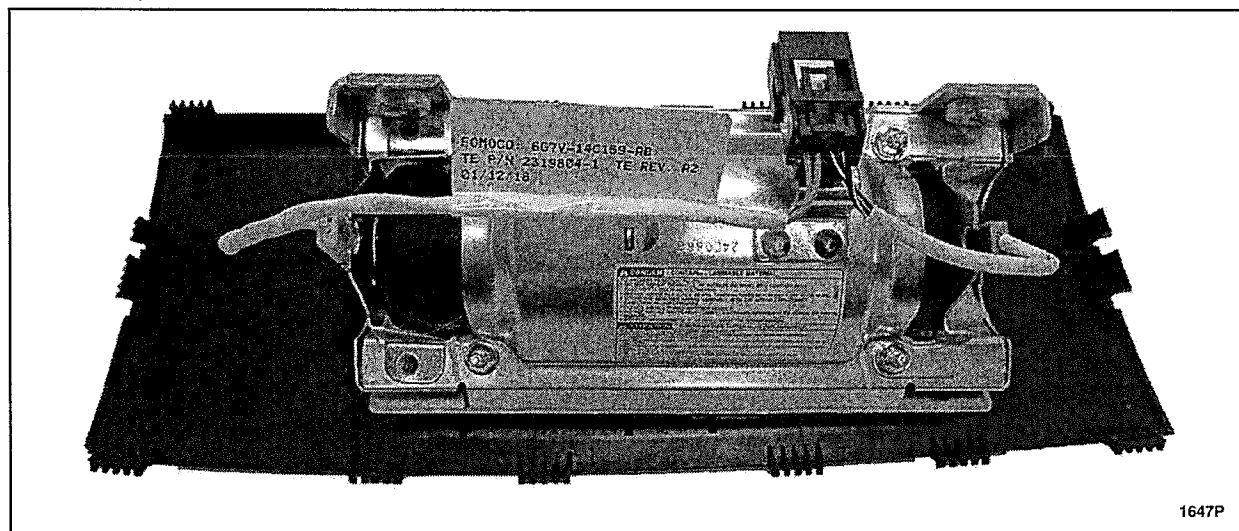

FIGURE 11



14. Insert the inflator wiring harness connector tabs. See Figure 12.

NOTE: Pull gently on the wiring harness to ensure it is properly seated.

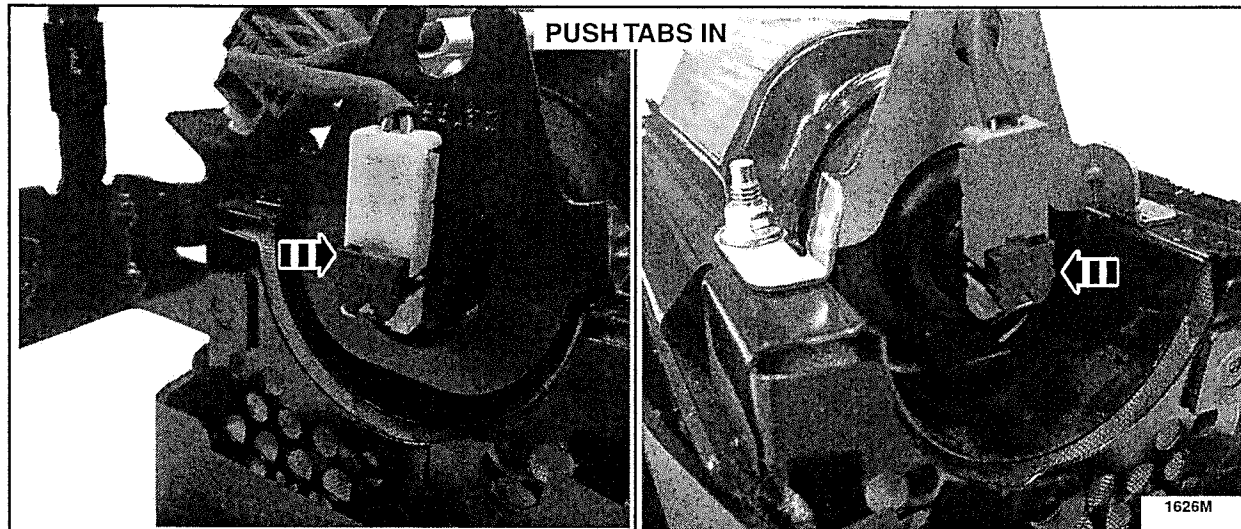

FIGURE 11

15. Re-install the passenger airbag. Please follow WSM procedures in Section 501-20B.

16. Package the replaced inflator in the *new* part box and provide to the appropriate dealership personnel for part returns.



CERTAIN 2010 AND 2013 MUSTANG VEHICLES — PASSENGER AIRBAG INFLATOR REPLACEMENT

OVERVIEW

NHTSA and Takata have determined that the propellant in certain Takata airbag inflators can experience an alteration over time with exposure to certain climate conditions. A combination of time, high temperature fluctuations, and humidity contribute to the degradation of the propellant in the inflators. This degradation can cause the propellant to burn too quickly, creating high pressure inside the inflator, and in extreme cases causing the inflator to rupture in the event of a crash necessitating airbag deployment. A ruptured inflator can send inflator parts toward vehicle occupants resulting in serious injury or death.

Dealers are to replace the passenger airbag inflator. The serial number from the new airbag inflator must be recorded on the repair order. Place the replaced inflator into the packaging from the new part and provide to the appropriate dealership personnel for part returns.

NOTE: For vehicles that the airbags have deployed or that have other modifications preventing the recall repair from being completed, submit a VIN specific request to the SSSC Web Contact Site prior to attempting a repair. Attach pictures of the vehicles airbag modules to the request.

SERVICE PROCEDURE

Recommended Tools:

1/4" Drive Deep Socket - 7mm
1/4" Drive Ratchet
1/4" Drive Extension - 6" (152mm)
1/4" Drive Shallow Socket - 8mm
1/4" Drive Impact Driver
1/4" Drive Torque Wrench
Side Cutters
Utility Knife
Needle Nose Pliers
Pocket Screwdriver



AIRBAG INFLATOR REPLACEMENT

NOTE: The following repair instructions only apply to 2010 and 2013 Mustang vehicles. Repair instructions will be published in separate attachments for the other vehicle lines included in this recall as parts become available for those vehicles.

NOTE: The parts used in this safety recall may physically appear to be identical, but they have differing operating characteristics. It is crucial that parts are not interchanged or substituted.

 **WARNING:** Failure to follow the instructions and warnings in the Workshop Manual (WSM) may result in injury.

NOTE: If the Airbag Readiness light indicates no Supplemental Restraint System (SRS) faults are present, it is not necessary to follow the WSM SRS Depowering and Repowering steps. Turn the ignition to OFF and wait 1 minute, then it is safe to proceed with airbag inflator replacement.

NOTE: The ignition must remain OFF until this service procedure is completed.

NOTE: To view a video demonstration of this repair procedure, click the video icon. 



NOTE: For Mustang vehicles equipped with SYNC, it is not necessary to remove the Accessory Protocol Interface Module (APIM) retainers to access the passenger airbag module. Unclip the APIM mounting bracket and position the APIM aside.

1. Remove the passenger airbag from the vehicle. Please follow the WSM procedures in Section 501-20B.
2. Set the airbag face down onto a surface that will not scratch or damage the airbag face.
3. Remove the wiring harness connector retainer from the passenger airbag assembly. See Figure 1.

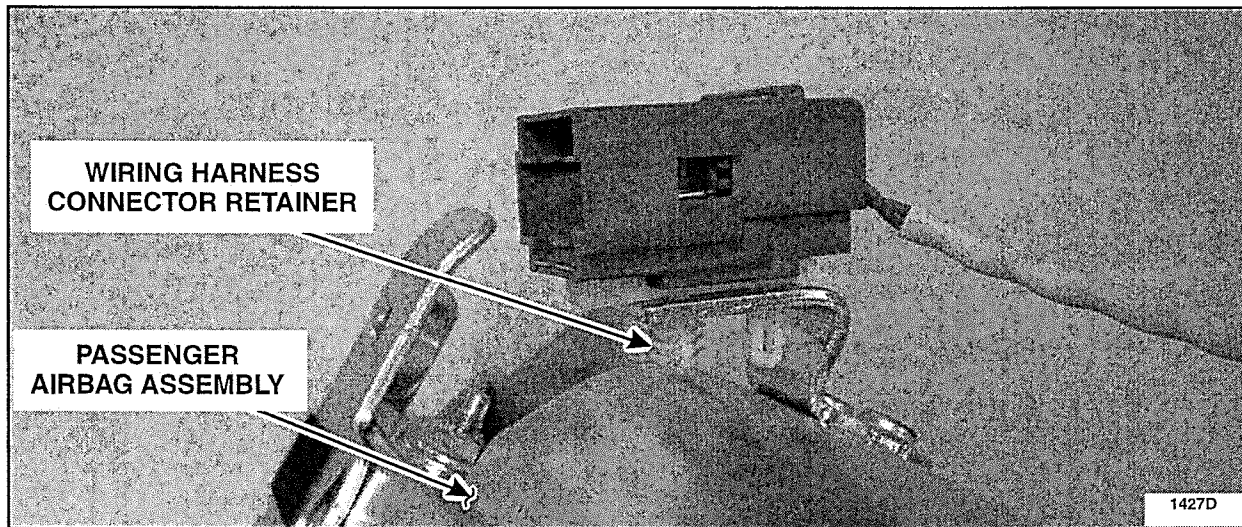

FIGURE 1

NOTE: Carry out this step on the longer wire on the end opposite of the airbag inflator retaining bracket. See Figure 2.

4. Remove approximately 100 mm (3.93 in) of the conduit from the passenger airbag assembly wire harness. See Figure 2.

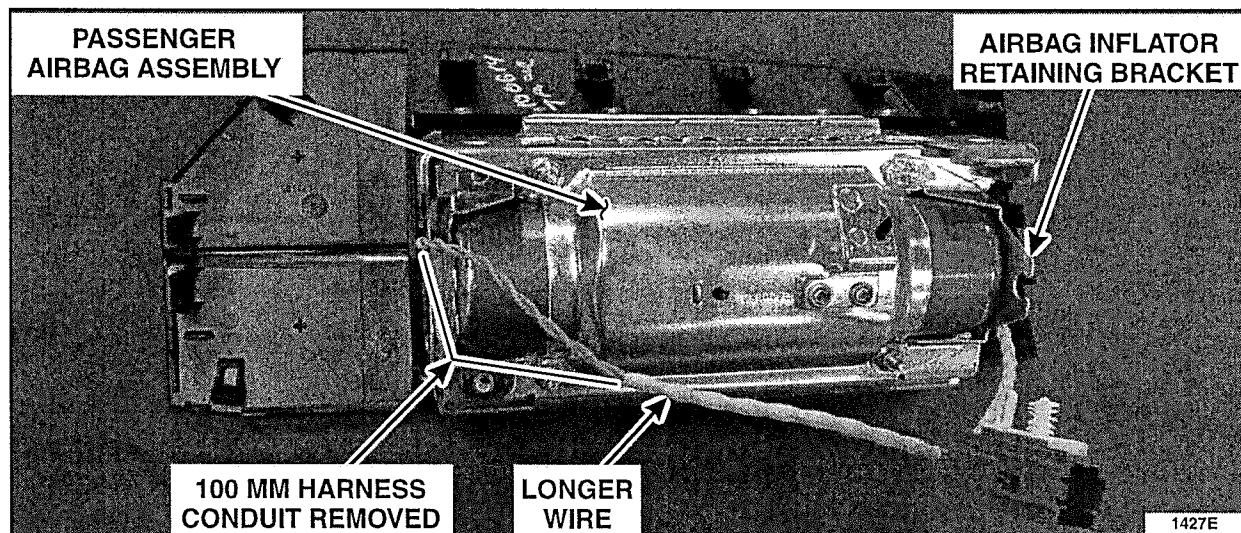

FIGURE 2



5. Position the shorting clip onto the harness wires, and crimp the shorting clip together one side at a time using pliers. See Figure 3.

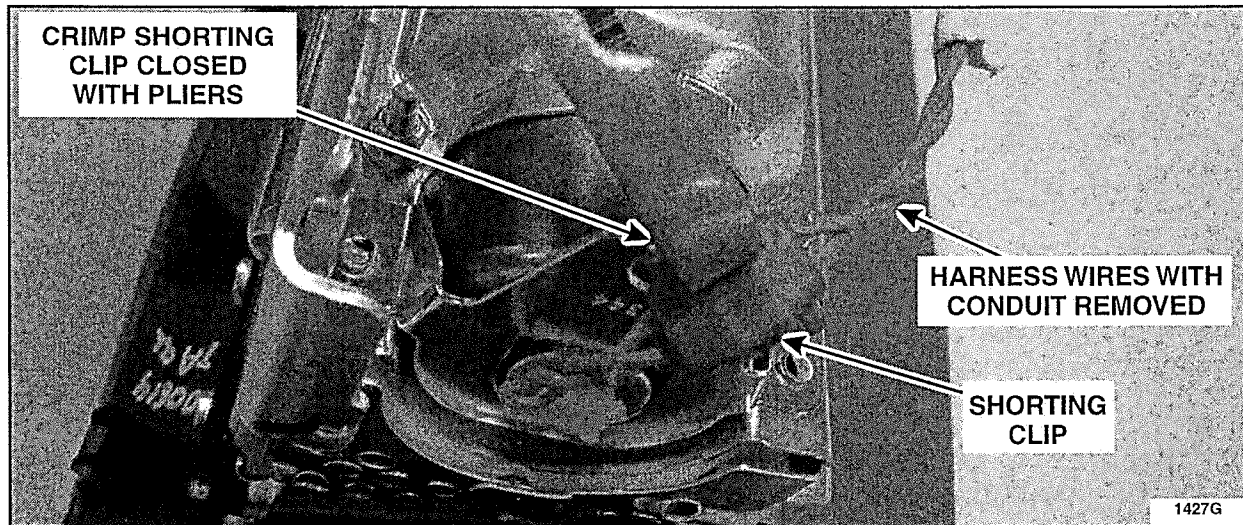

FIGURE 3

6. Cut the harness wires between the shorting clip and the harness connector. See Figure 4.

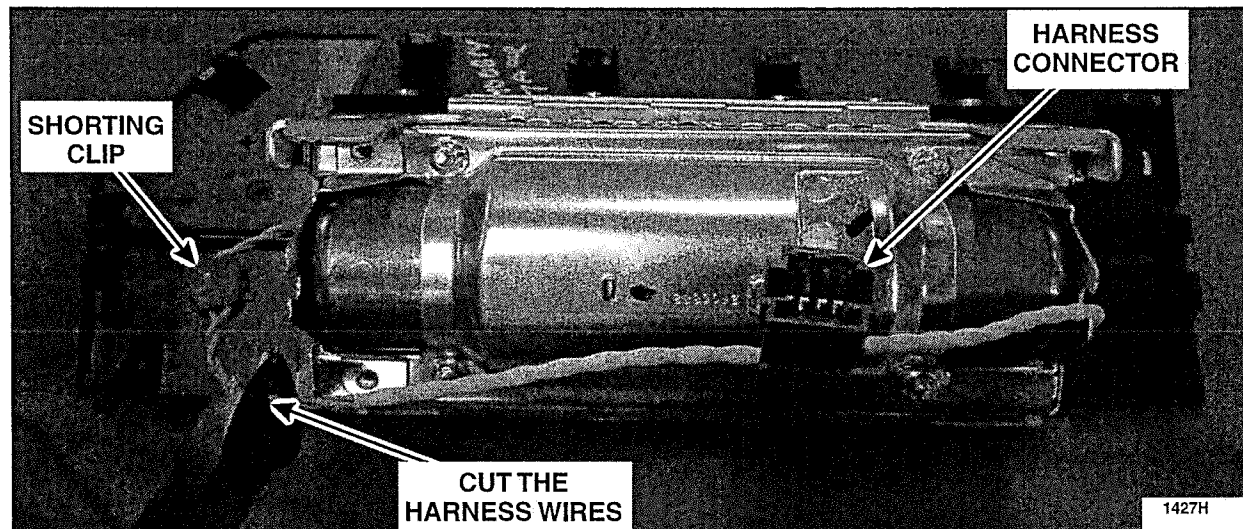

FIGURE 4



7. Remove and discard the four passenger airbag inflator retaining bracket nuts and the retaining bracket. See Figure 5.

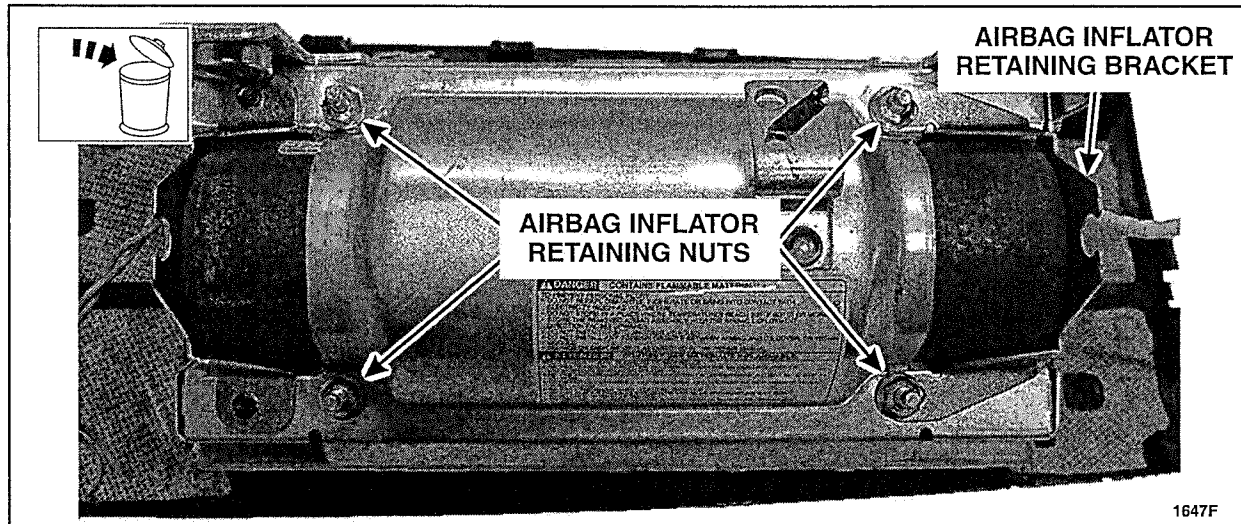

FIGURE 5

WARNING: Do not allow any debris on or around the airbag once the inflator is removed.

8. With an assistant holding the passenger airbag assembly, remove the inflator from the assembly by pushing outward on the inflator. Set the airbag inflator aside for return shipping. See Figure 6.

- If required, use of a brass punch is permitted (only at the location shown) to free the inflator from its mounted position.

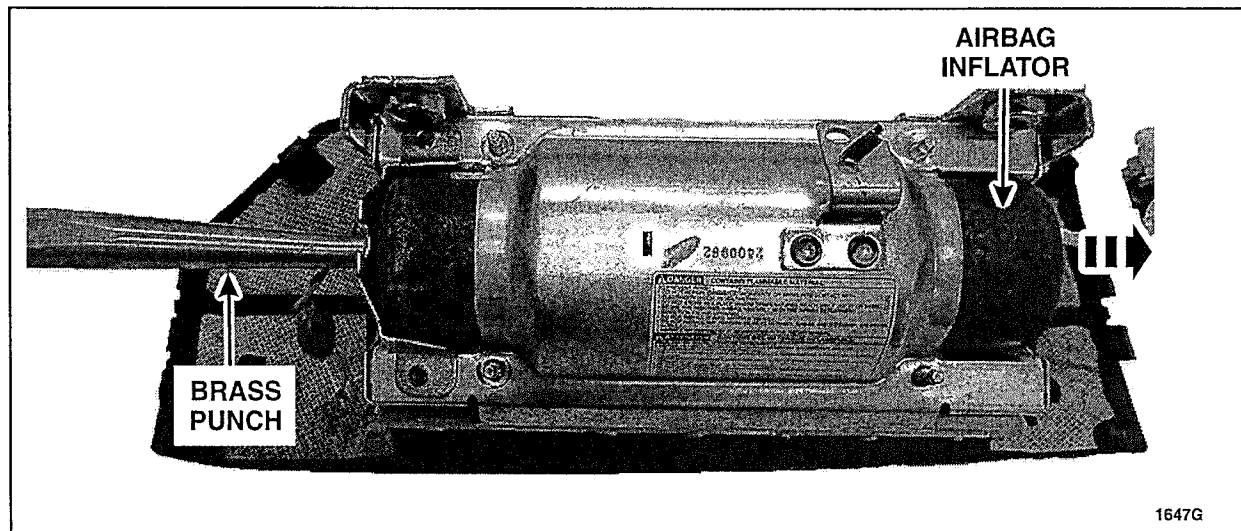

FIGURE 6



NOTE: The serial number of the new airbag inflator must be provided to Ford for the warranty claim to be processed.

9. Record the 11 character serial number of the *new* airbag inflator on the repair order. See Figure 7.

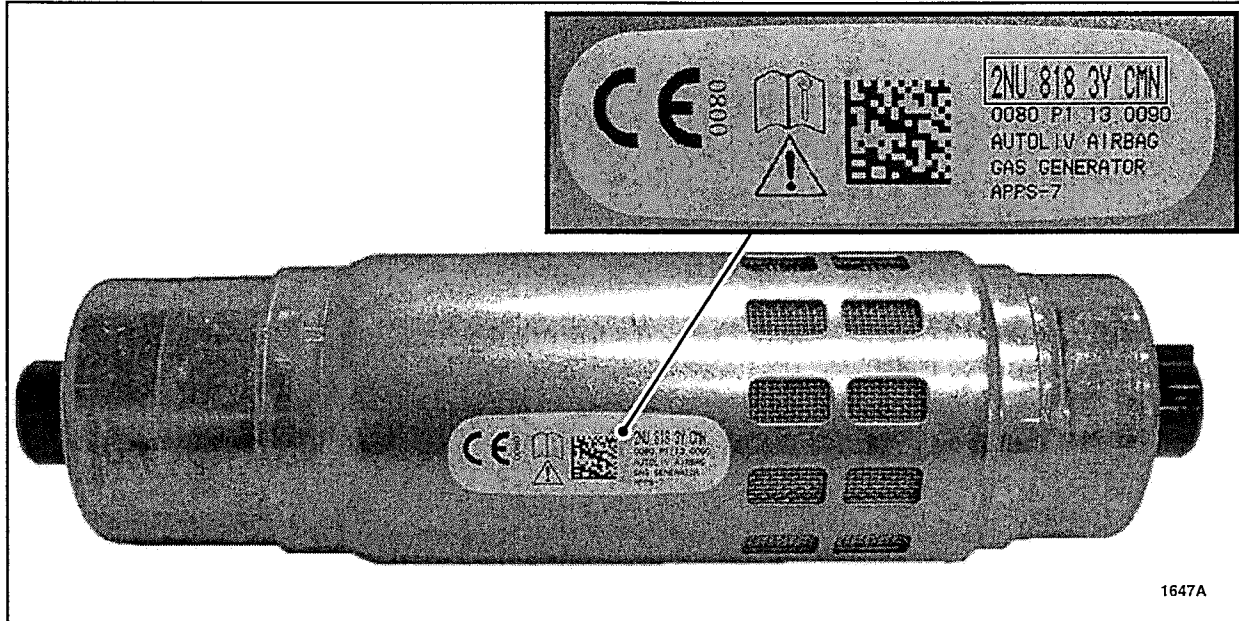

FIGURE 7



10. **NOTE:** Both *new* inflator end caps are specific to their respective end of the inflator and must be fully seated.

NOTE: The tail end cap does not have an alignment tab and may be installed in any orientation.

Install both *new* inflator end caps making sure the alignment feature on the cap nearest the inflator retaining bracket is properly oriented. See Figure 8.

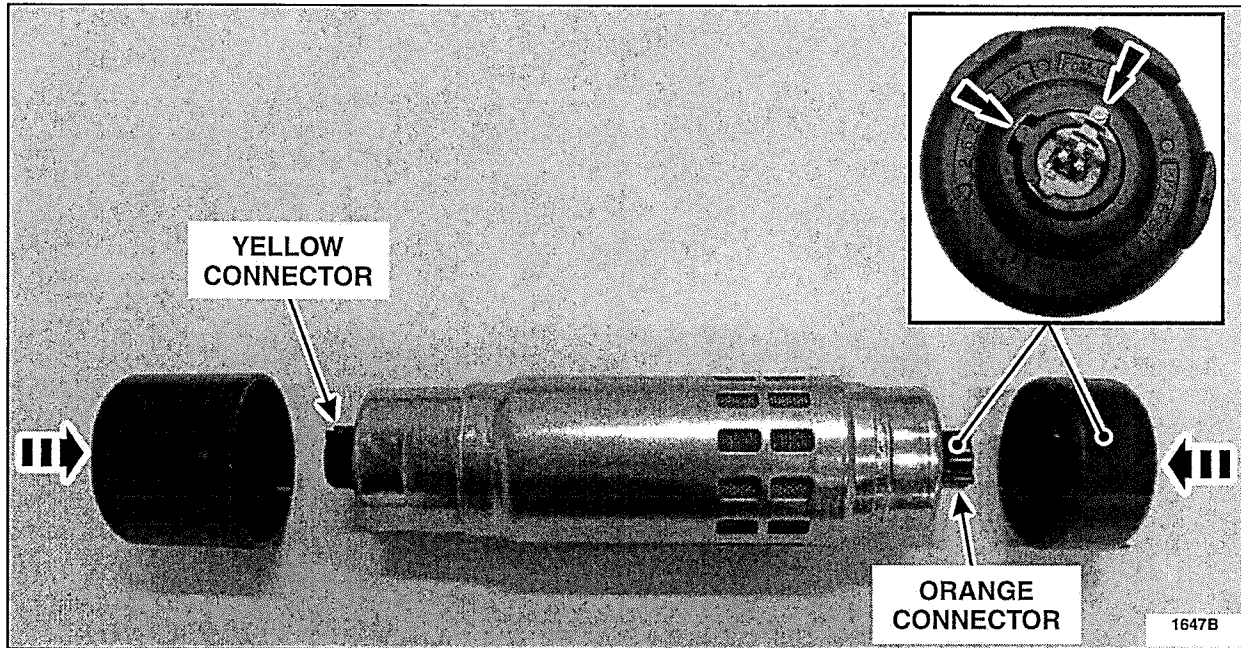

FIGURE 8

11. Install the inflator into the passenger airbag assembly with the orange connector end facing out. Align the three tabs on the cap nearest the inflator retaining bracket with the airbag module lower channel (facing down). See Figure 9.

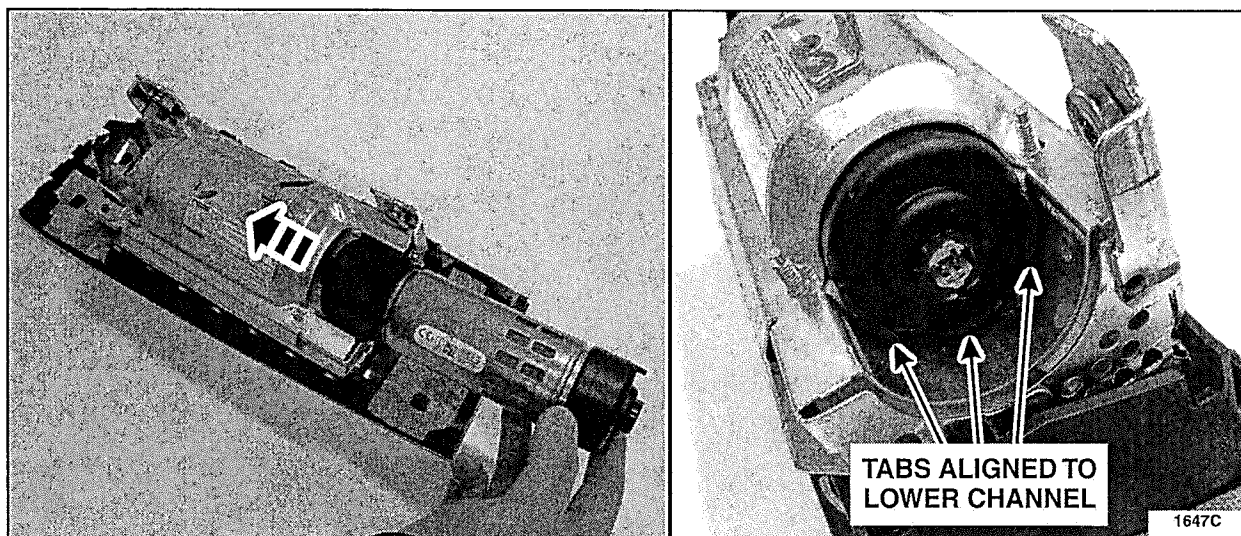

FIGURE 9



NOTE: If the inflator retaining bracket is unable to be installed, ensure the inflator tail end cap is fully seated.

12. Install the *new* passenger airbag inflator retaining bracket and *new* nuts. See Figure 10.

- Torque the new retaining nuts in the sequence shown below to 4 Nm (35 lb-in).

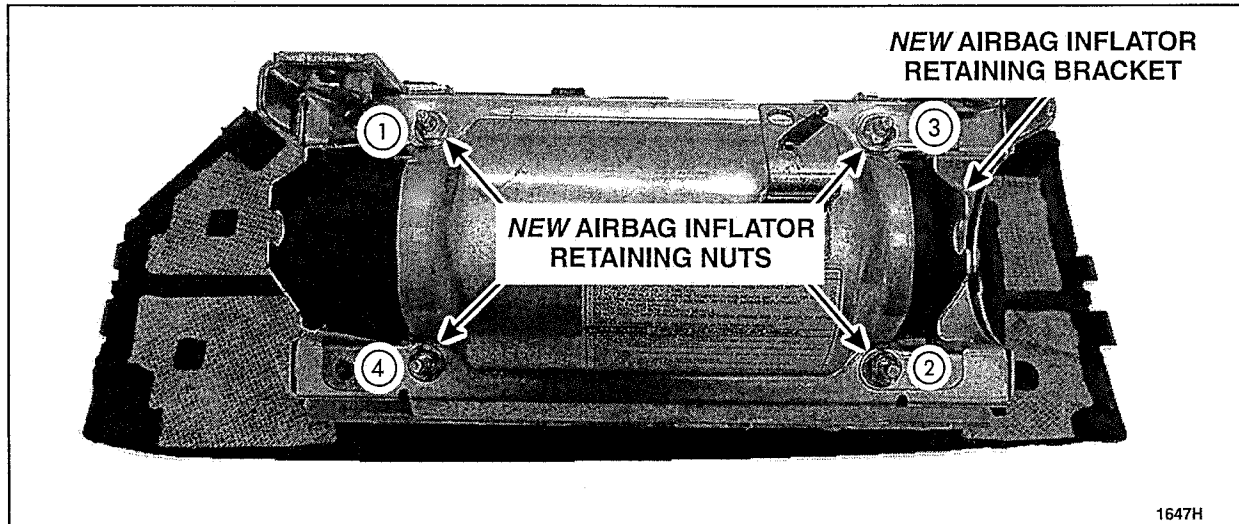

FIGURE 10

13. Align the T-shape index on both the wiring harness electrical connector and the airbag inflator. Install the new wiring harness onto the passenger airbag module and connect to both sides of the inflator. See Figure 11.

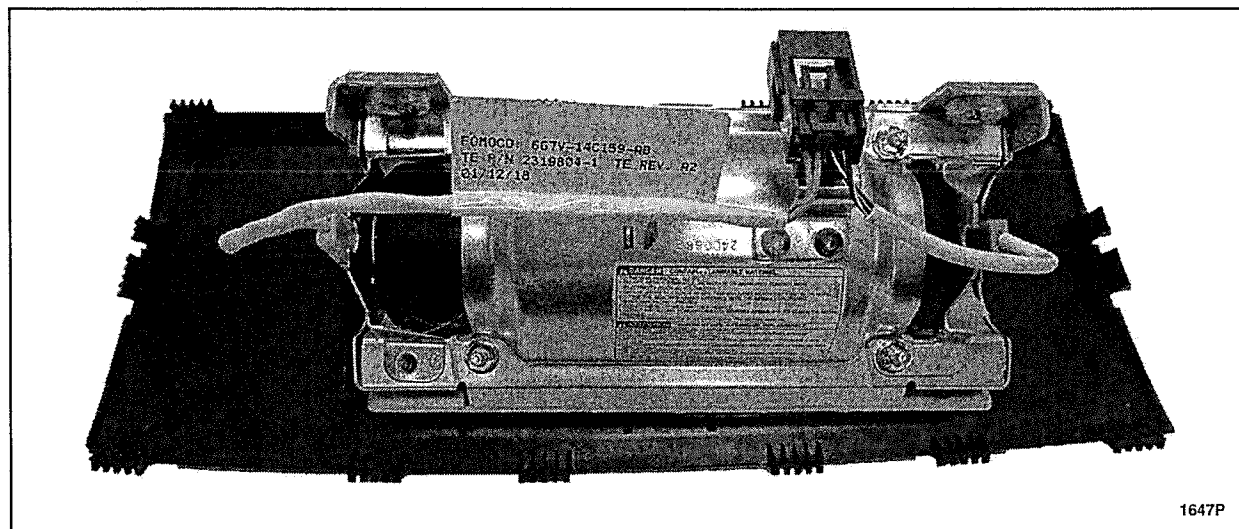

FIGURE 11



14. Insert the inflator wiring harness connector tabs. See Figure 12.

NOTE: Pull gently on the wiring harness to ensure it is properly seated.

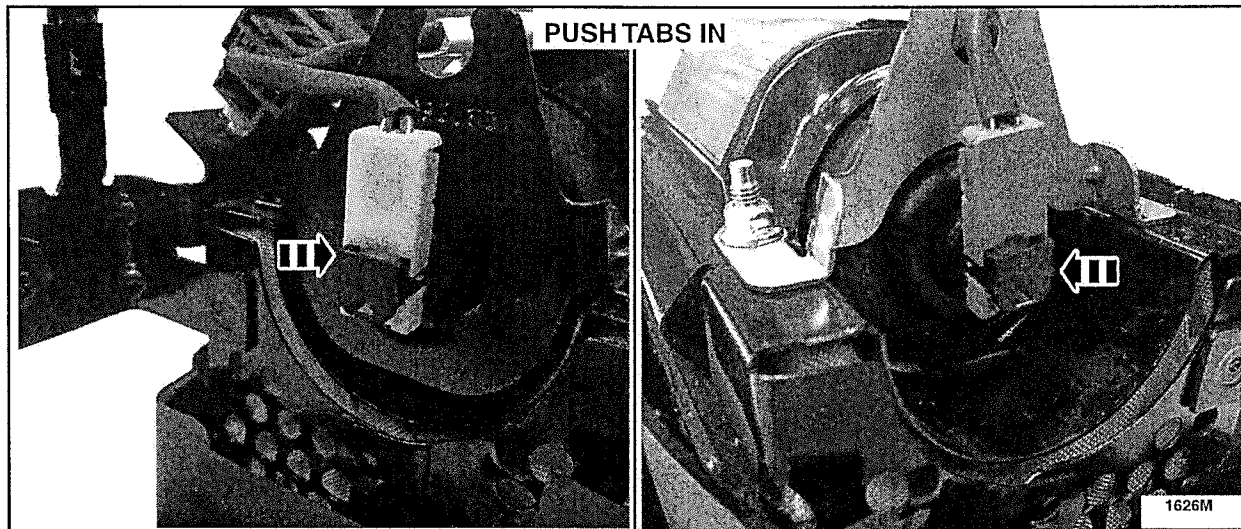

FIGURE 12

15. Re-install the passenger airbag. Please follow WSM procedures in Section 501-20B.

16. Package the replaced inflator in the *new* part box and provide to the appropriate dealership personnel for part returns.



CERTAIN 2009-2010 RANGER VEHICLES — PASSENGER AIRBAG INFLATOR REPLACEMENT

OVERVIEW

NHTSA and Takata have determined that the propellant in certain Takata airbag inflators can experience an alteration over time with exposure to certain climate conditions. A combination of time, high temperature fluctuations, and humidity contribute to the degradation of the propellant in the inflators. This degradation can cause the propellant to burn too quickly, creating high pressure inside the inflator, and in extreme cases causing the inflator to rupture in the event of a crash necessitating airbag deployment. A ruptured inflator can send inflator parts toward vehicle occupants resulting in serious injury or death.

Dealers are to replace the passenger airbag inflator. The serial number from the new airbag inflator must be recorded on the repair order. Place the replaced inflator into the packaging from the new part and provide to the appropriate dealership personnel for part returns.

NOTE: For vehicles that the airbags have deployed or that have other modifications preventing the recall repair from being completed, submit a VIN specific request to the SSSC Web Contact Site prior to attempting a repair. Attach pictures of the vehicles airbag modules to the request.

SERVICE PROCEDURE

Recommended Tools:

1/4" Drive Deep Socket - 7mm
1/4" Drive Ratchet
1/4" Drive Extension - 6" (152mm)
1/4" Drive Shallow Socket - 8mm
1/4" Drive Impact Driver
1/4" Drive Torque Wrench
Side Cutters
Utility Knife
Needle Nose Pliers
Pocket Screwdriver



AIRBAG INFLATOR REPLACEMENT

NOTE: The following repair instructions only apply to 2009 - 2010 Ranger vehicles. Repair instructions will be published in separate attachments for the other vehicle lines included in this recall as parts become available for those vehicles.

NOTE: The parts used in this safety recall may physically appear to be identical, but they have differing operating characteristics. It is crucial that parts are not interchanged or substituted.

 **WARNING:** Failure to follow the instructions and warnings in the Workshop Manual (WSM) may result in injury.

NOTE: If the Airbag Readiness light indicates no Supplemental Restraint System (SRS) faults are present, it is not necessary to follow the WSM SRS Depowering and Repowering steps. Turn the ignition to OFF and wait 1 minute, then it is safe to proceed with airbag inflator replacement.

NOTE: The ignition must remain OFF until this service procedure is completed.



1. Remove the passenger airbag from the vehicle. Please follow the WSM procedures in Section 501-20B.
2. Set the airbag face down onto a surface that will not scratch or damage the airbag face.
3. Remove the wiring harness connector retainer from the passenger airbag assembly. See Figure 1.

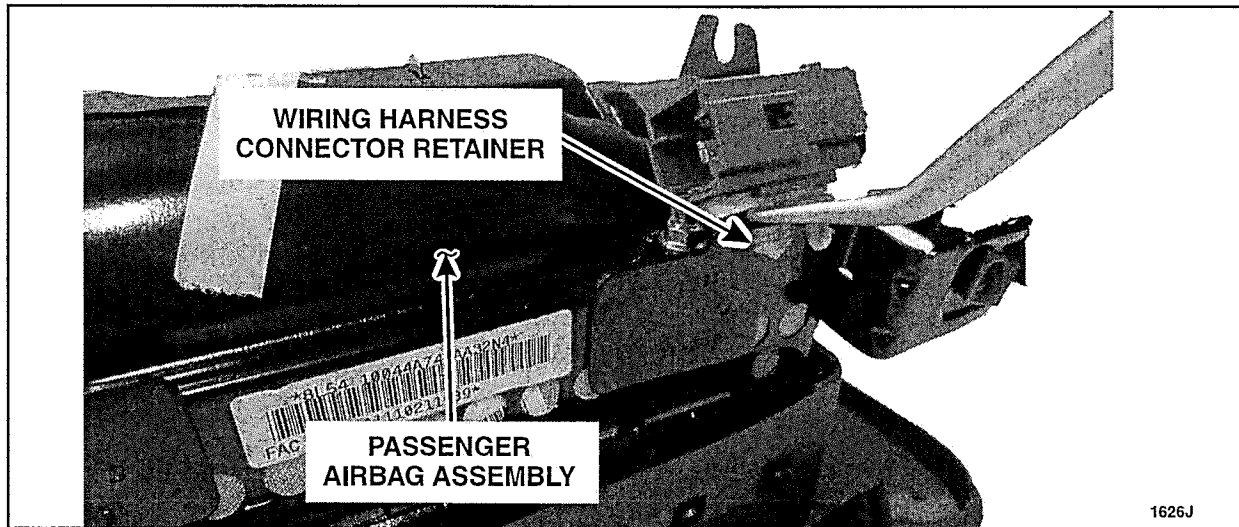

FIGURE 1

NOTE: Carry out this step on the shorter wire on the end opposite of the airbag inflator retaining bracket. See Figure 2.

4. Remove the black conduit from the passenger airbag assembly wire harness in the area shown. See Figure 2.

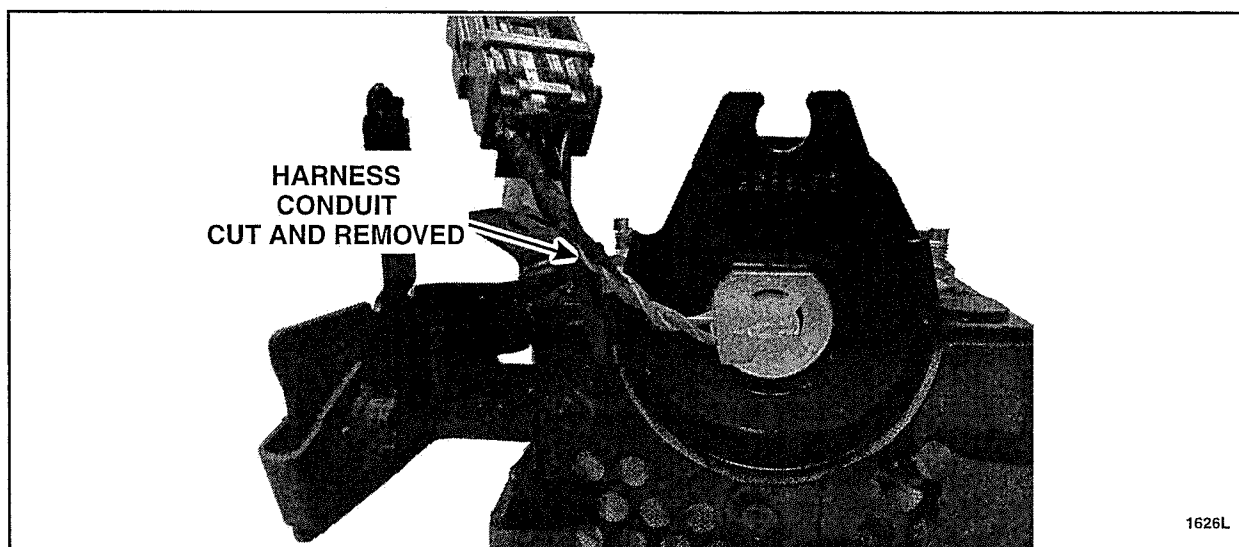

FIGURE 2



5. Position the shorting clip onto the harness wires, and crimp the shorting clip together one side at a time using pliers. See Figure 3.
6. Cut the harness wires between the shorting clip and the harness connector. See Figure 3.

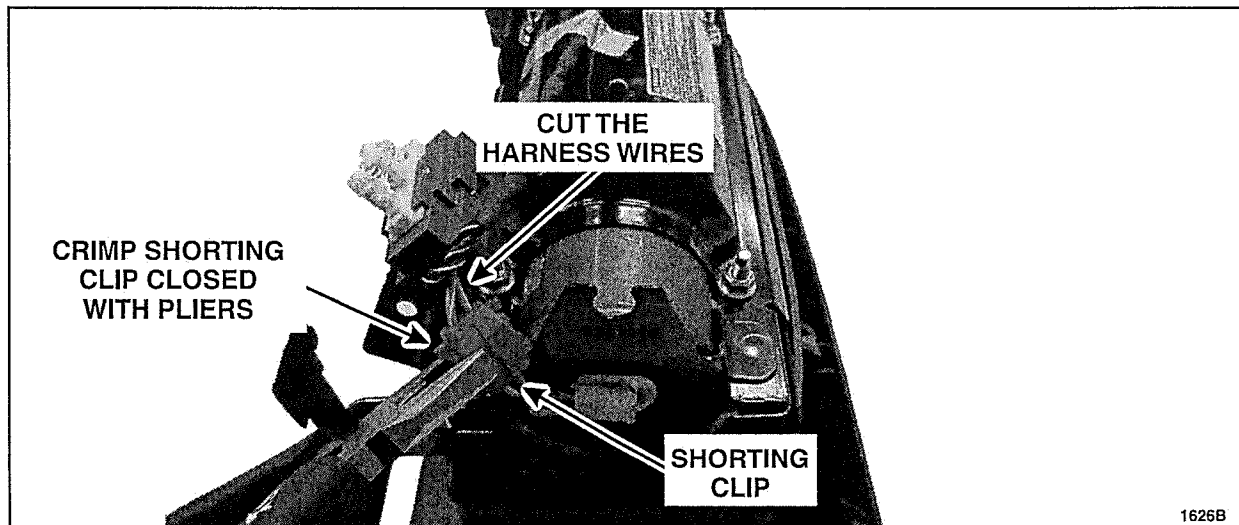

FIGURE 3

7. Remove and discard the four passenger airbag inflator retaining bracket nuts and the retaining bracket. See Figure 4.

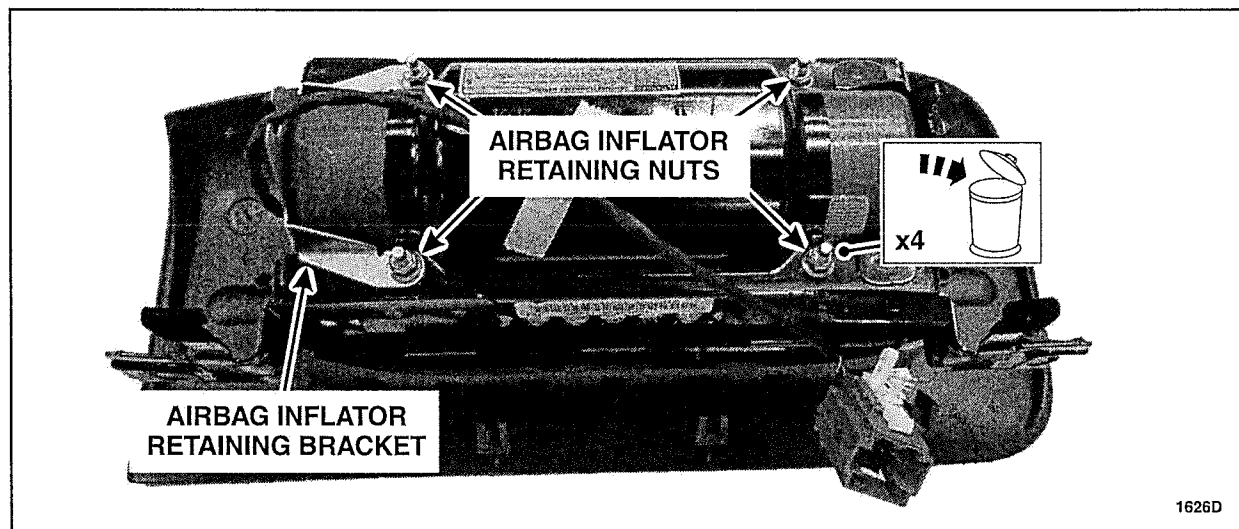

FIGURE 4



⚠ WARNING: Do not allow any debris on or around the airbag once the inflator is removed.

8. With an assistant holding the passenger airbag assembly, remove the inflator from the assembly by pushing outward on the inflator. Set the airbag inflator aside for return shipping. See Figure 5.

- If required, use of a brass punch is permitted (only at the location shown) to free the inflator from its mounted position.

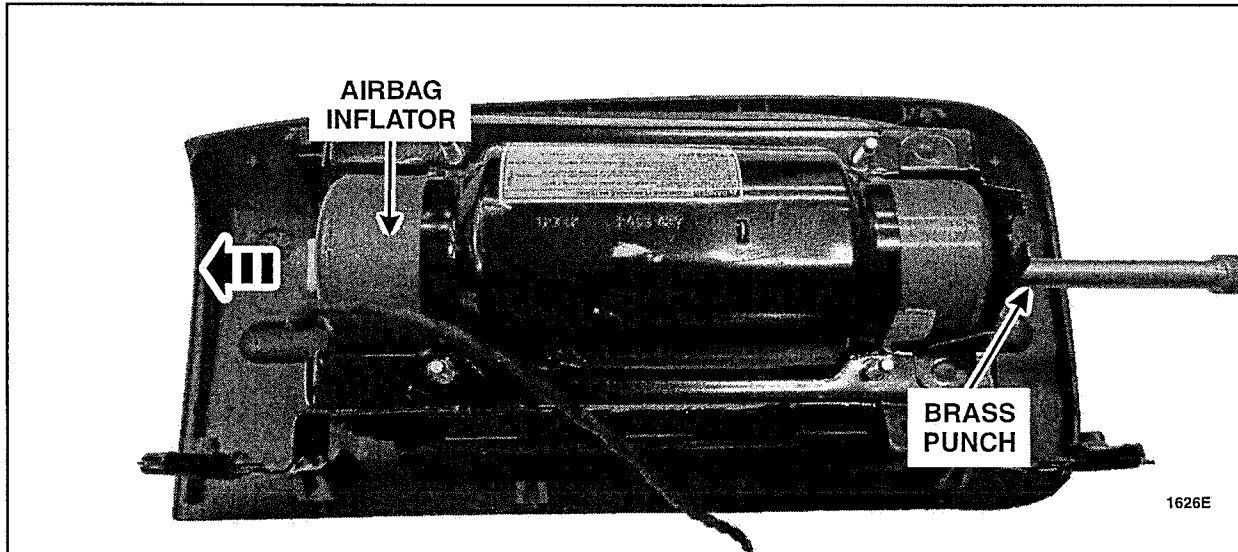

FIGURE 5

NOTE: The serial number of the new airbag inflator must be provided to Ford for the warranty claim to be processed.

9. Record the 11 character serial number of the *new* airbag inflator on the repair order. See Figure 6.

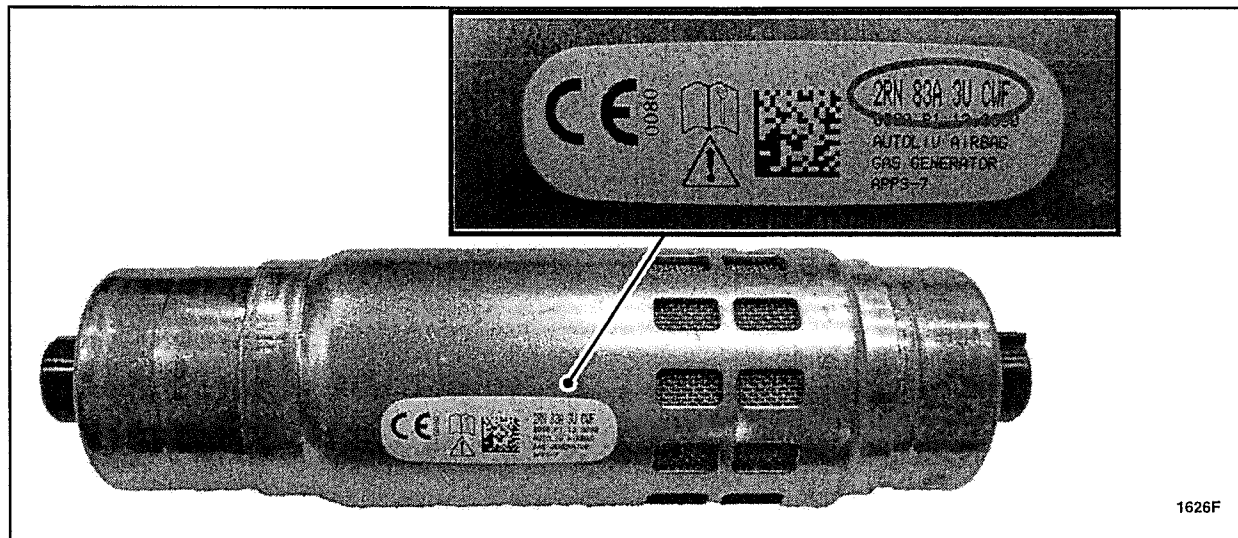

FIGURE 6



10. **NOTE:** Both *new* inflator end caps are specific to their respective end of the inflator and must be fully seated.

NOTE: The tail end cap does not have an alignment tab and may be installed in any orientation. Make sure the tail end cap is fully seated or you will not be able to install the inflator retaining bracket.

Install both *new* inflator end caps making sure the alignment feature on the cap nearest the inflator retaining bracket is properly oriented. See Figure 7.

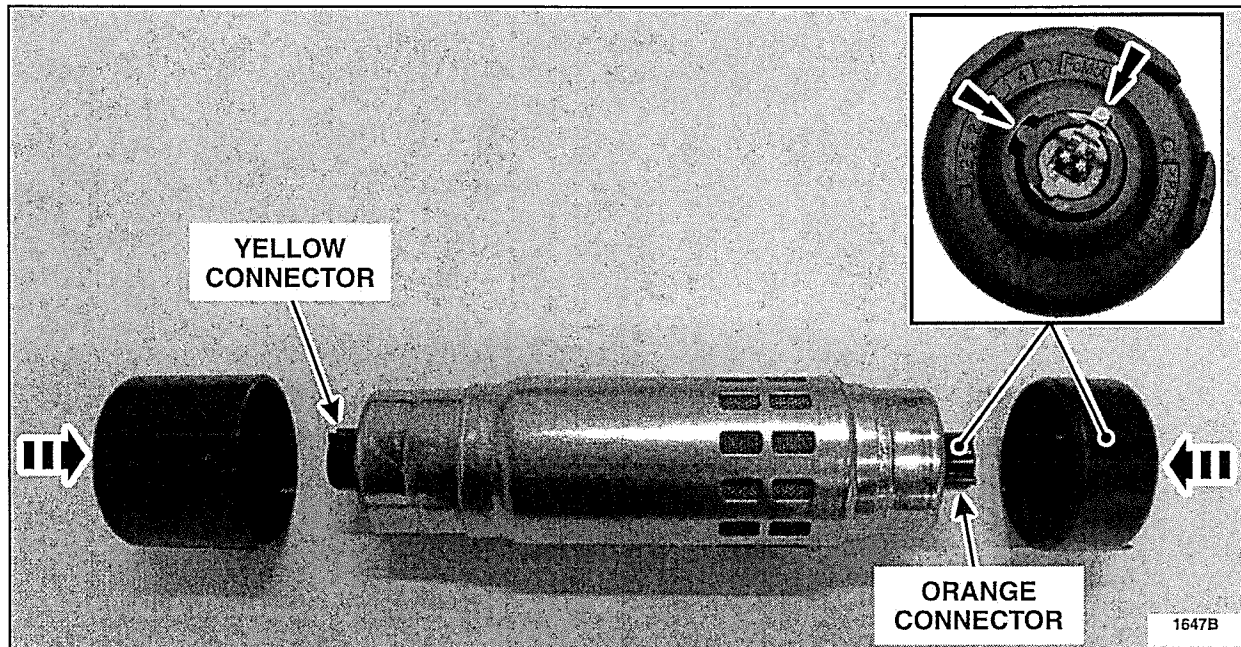

FIGURE 7



11. Install the inflator into the passenger airbag assembly with the orange connector end facing out. Align the three tabs on the cap nearest the inflator retaining bracket with the airbag module lower channel (facing down). See Figure 8.

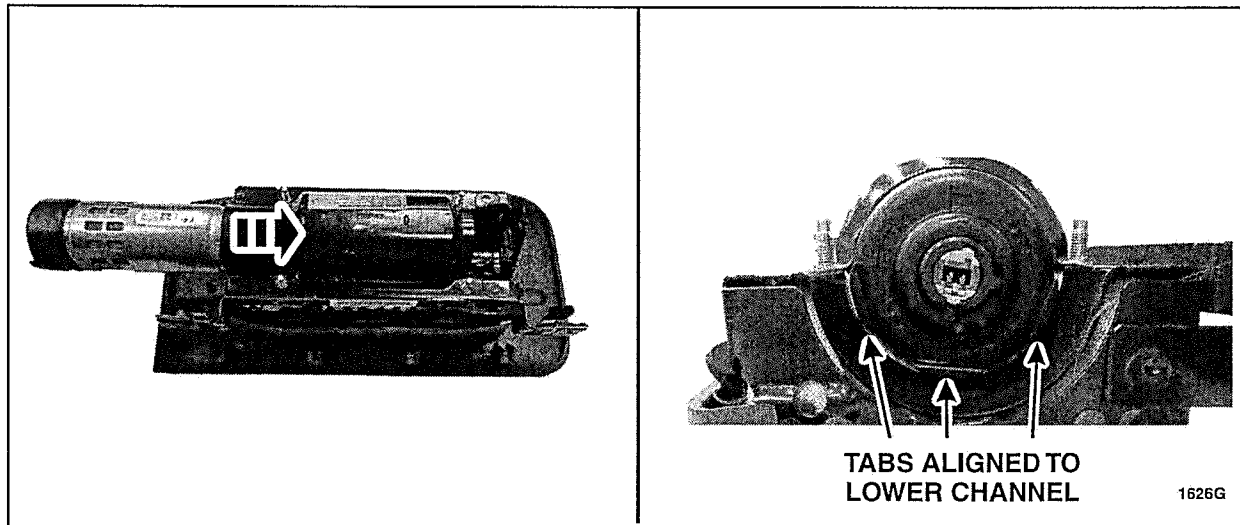

FIGURE 8

NOTE: If the inflator retaining bracket is unable to be installed, ensure the inflator tail end cap is fully seated.

12. Install the *new* passenger airbag inflator retaining bracket and *new* nuts. See Figure 9.

- Torque the new retaining nuts in the sequence shown below. Tighten to 4 Nm (35 lb in).

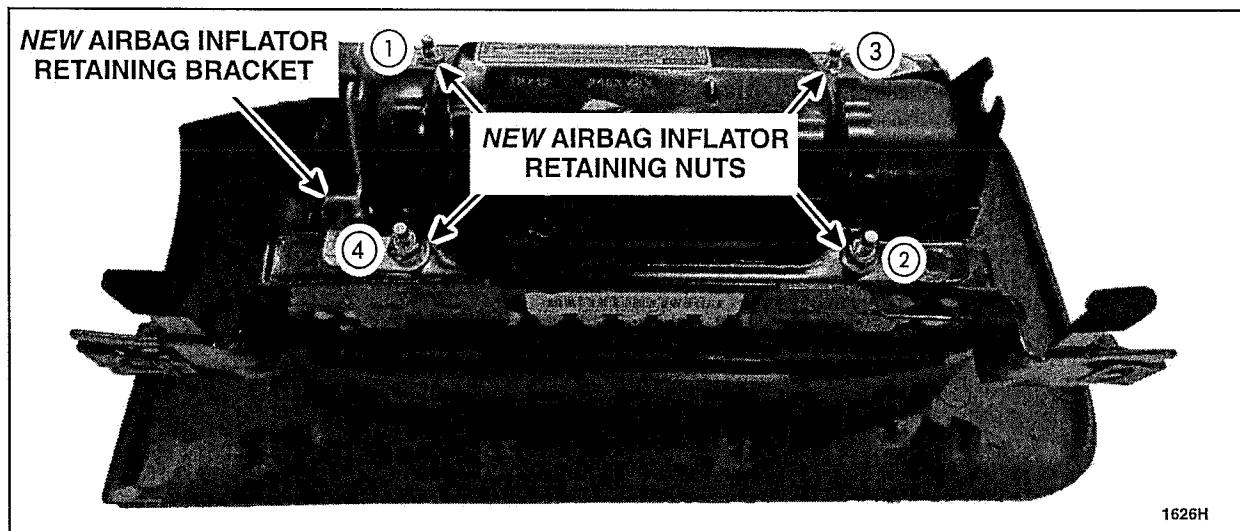

FIGURE 9



- Align the T-shape index on both the wiring harness electrical connector and the airbag inflator. Install the *new* wiring harness onto the passenger airbag module and connect to both sides of the inflator and fully seat the black tabs. See Figure 10.

NOTE: Pull gently on the wiring harness to ensure it is properly seated.

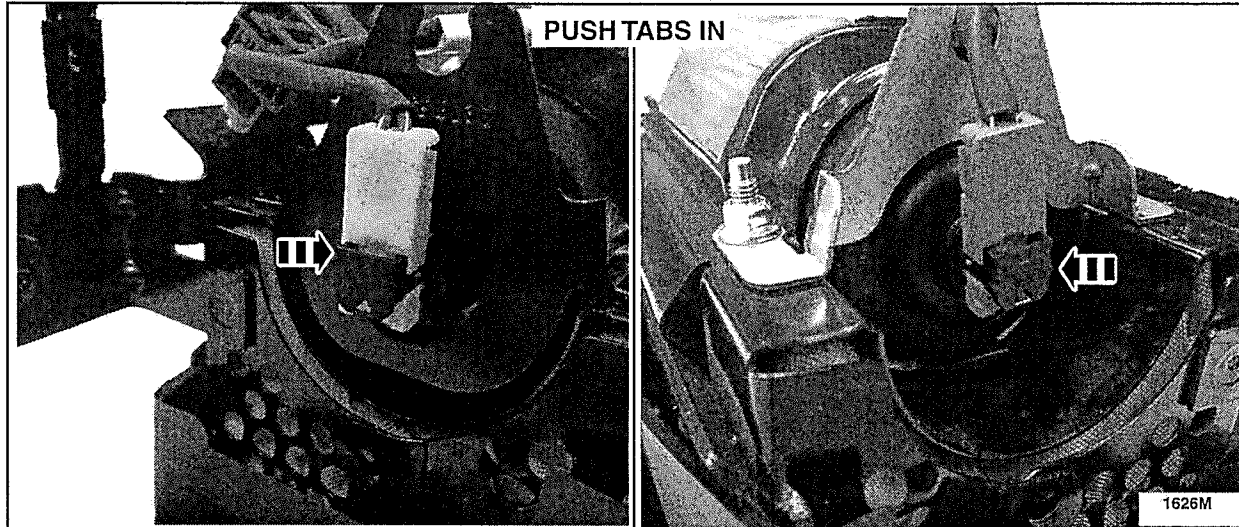

FIGURE 10

- Install the *new* tape to the wiring harness and airbag assembly, do not cover the airbag warning label with the new tape. For correct placement See Figure 11.

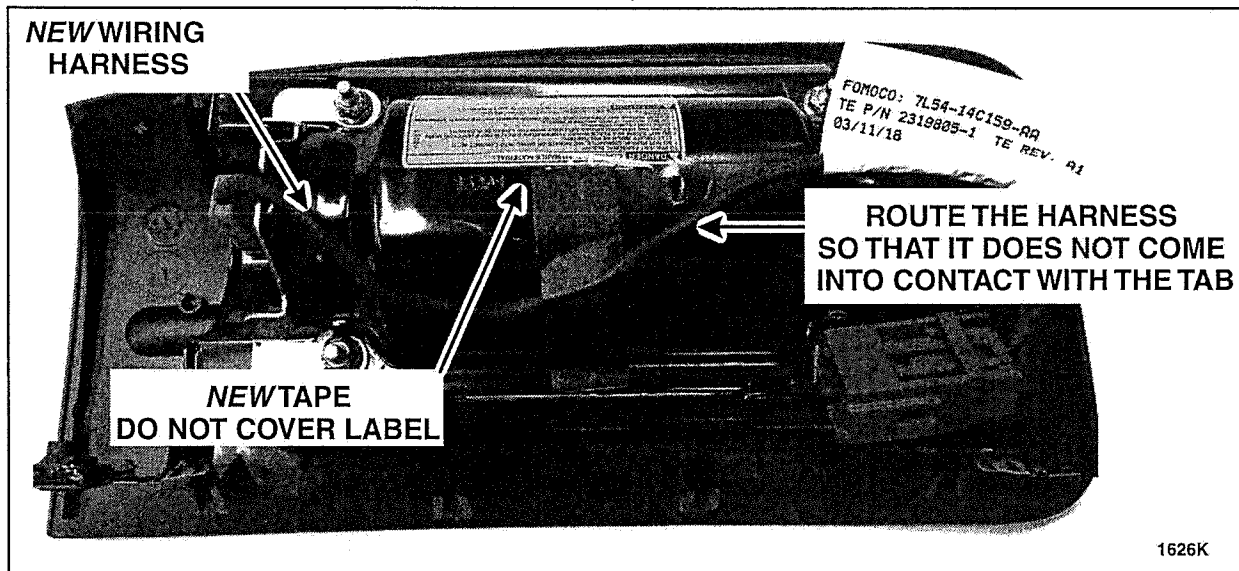

FIGURE 11

- Re-install the passenger airbag. Please follow WSM procedures in Section 501-20B.
- Package the replaced inflator in the *new* part box and provide to the appropriate dealership personnel for part returns.



CERTAIN 2009 MKZ VEHICLES – PASSENGER AIRBAG MODULE REPLACEMENT

OVERVIEW

Takata has determined that the propellant wafers in some airbag inflators may experience an alteration over time, which could potentially lead to an over-aggressive combustion in the event of a crash that requires airbag deployment. This potential condition could create excessive internal pressure when the airbag is deployed, which could result in the body of the inflator rupturing upon deployment increasing the risk of injury to occupants.

Dealers are to replace the passenger airbag module. The serial number from the new airbag module must be recorded on the repair order. Place the replaced airbag module into the packaging from the new part and provide to the appropriate dealership personnel for part returns.

NOTE: For vehicles that the airbags have deployed or that have other modifications preventing the recall repair from being completed, submit a VIN specific request to the SSSC Web Contact Site prior to attempting a repair. Attach pictures of the vehicles airbag modules to the request.

SERVICE PROCEDURE

NOTE: The following repair instructions only apply to 2009 MKZ vehicles. Repair instructions will be published in separate attachments for other vehicle lines included in this recall as parts become available for those vehicles.

NOTE: The parts used in this safety recall may physically appear to be identical, but they have differing operating characteristics. It is crucial that parts are not interchanged or substituted.

 **WARNING: Failure to follow the instructions and warnings in the Workshop Manual (WSM) may result in injury.**

NOTE: If the Airbag Readiness light indicates no Supplemental Restraint System (SRS) faults are present, it is not necessary to follow the WSM SRS Depowering and Repowering steps. Turn the ignition to OFF and wait 1 minute, then it is safe to proceed with airbag inflator replacement.

NOTE: The ignition must remain OFF until this service procedure is completed.



1. Record the 13 character serial number of the new airbag module on the repair order. See Figure 1.
2. Replace the passenger airbag module. Refer to section 501-20B of the Workshop Manual.

NOTE: Use caution when removing the 5 instrument panel trim panel fasteners or the studs may strip out. Submit a contact to the SSSC if damage to the trim panel does occur.

3. Package the replaced airbag module in the new part box and provide to the appropriate dealership personnel for part returns.

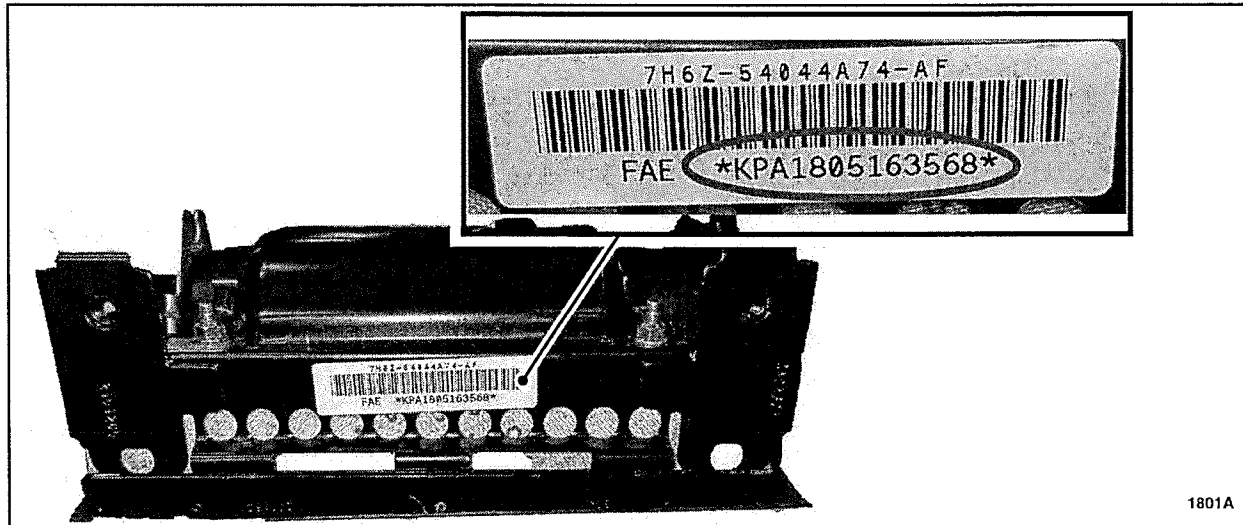

FIGURE 1



CERTAIN 2009 FUSION AND MILAN VEHICLES – PASSENGER AIRBAG MODULE REPLACEMENT

OVERVIEW

Takata has determined that the propellant wafers in some airbag inflators may experience an alteration over time, which could potentially lead to an over-aggressive combustion in the event of a crash that requires airbag deployment. This potential condition could create excessive internal pressure when the airbag is deployed, which could result in the body of the inflator rupturing upon deployment increasing the risk of injury to occupants.

Dealers are to replace the passenger airbag module. The serial number from the new airbag module must be recorded on the repair order. Place the replaced airbag module into the packaging from the new part and provide to the appropriate dealership personnel for part returns.

NOTE: For vehicles that the airbags have deployed or that have other modifications preventing the recall repair from being completed, submit a VIN specific request to the SSSC Web Contact Site prior to attempting a repair. Attach pictures of the vehicles airbag modules to the request.

SERVICE PROCEDURE

NOTE: The following repair instructions only apply to 2009 Fusion and Milan vehicles. Repair instructions will be published in separate attachments for other vehicle lines included in this recall as parts become available for those vehicles.

NOTE: The parts used in this safety recall may physically appear to be identical, but they have differing operating characteristics. It is crucial that parts are not interchanged or substituted.

 **WARNING:** Failure to follow the instructions and warnings in the Workshop Manual (WSM) may result in injury.

NOTE: If the Airbag Readiness light indicates no Supplemental Restraint System (SRS) faults are present, it is not necessary to follow the WSM SRS Depowering and Repowering steps. Turn the ignition to OFF and wait 1 minute, then it is safe to proceed with airbag inflator replacement.

NOTE: The ignition must remain OFF until this service procedure is completed.



1. Record the 13 character serial number of the new airbag module on the repair order. See Figure 1.
2. Replace the passenger airbag module. Refer to section 501-20B of the workshop manual.
3. Package the replaced airbag module in the new part box and provide to the appropriate dealership personnel for part returns.

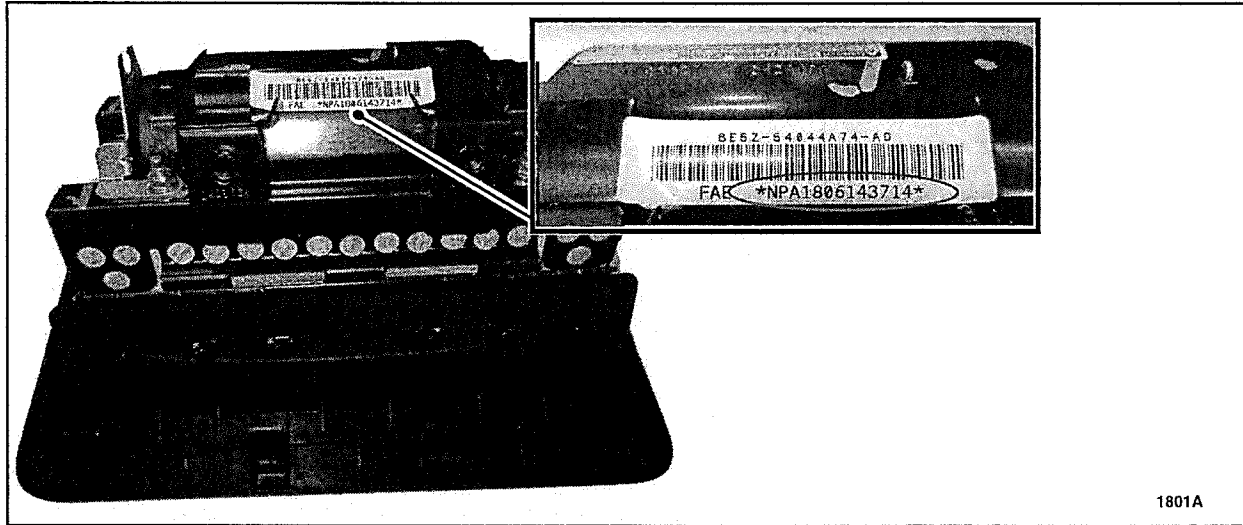

1801A

FIGURE 1



CERTAIN 2009 – 2010 EDGE VEHICLES – PASSENGER AIRBAG MODULE REPLACEMENT

OVERVIEW

Takata has determined that the propellant wafers in some airbag inflators may experience an alteration over time, which could potentially lead to an over-aggressive combustion in the event of a crash that requires airbag deployment. This potential condition could create excessive internal pressure when the airbag is deployed, which could result in the body of the inflator rupturing upon deployment increasing the risk of injury to occupants.

Dealers are to replace the passenger airbag module. The serial number from the new airbag module must be recorded on the repair order. Place the replaced airbag module into the packaging from the new part and provide to the appropriate dealership personnel for part returns.

NOTE: For vehicles that the airbags have deployed or that have other modifications preventing the recall repair from being completed, submit a VIN specific request to the SSSC Web Contact Site prior to attempting a repair. Attach pictures of the vehicles airbag modules to the request.

SERVICE PROCEDURE

NOTE: The following repair instructions only apply to 2009 and 2010 Edge vehicles. Repair instructions will be published in separate attachments for other vehicle lines included in this recall as parts become available for those vehicles.

NOTE: The parts used in this safety recall may physically appear to be identical, but they have differing operating characteristics. It is crucial that parts are not interchanged or substituted.

 **WARNING:** Failure to follow the instructions and warnings in the Workshop Manual (WSM) may result in injury.

NOTE: If the Airbag Readiness light indicates no Supplemental Restraint System (SRS) faults are present, it is not necessary to follow the WSM SRS Depowering and Repowering steps. Turn the ignition to OFF and wait 1 minute, then it is safe to proceed with airbag inflator replacement.

NOTE: The ignition must remain OFF until this service procedure is completed.



1. Record the 13 character serial number of the new airbag module on the repair order. See Figure 1.
2. Replace the passenger airbag module. Refer to section 501-20B of the Workshop Manual.

NOTE: Releasing the side tabs first will aid in the removal process.

3. Package the replaced airbag module in the new part box and provide to the appropriate dealership personnel for part returns.

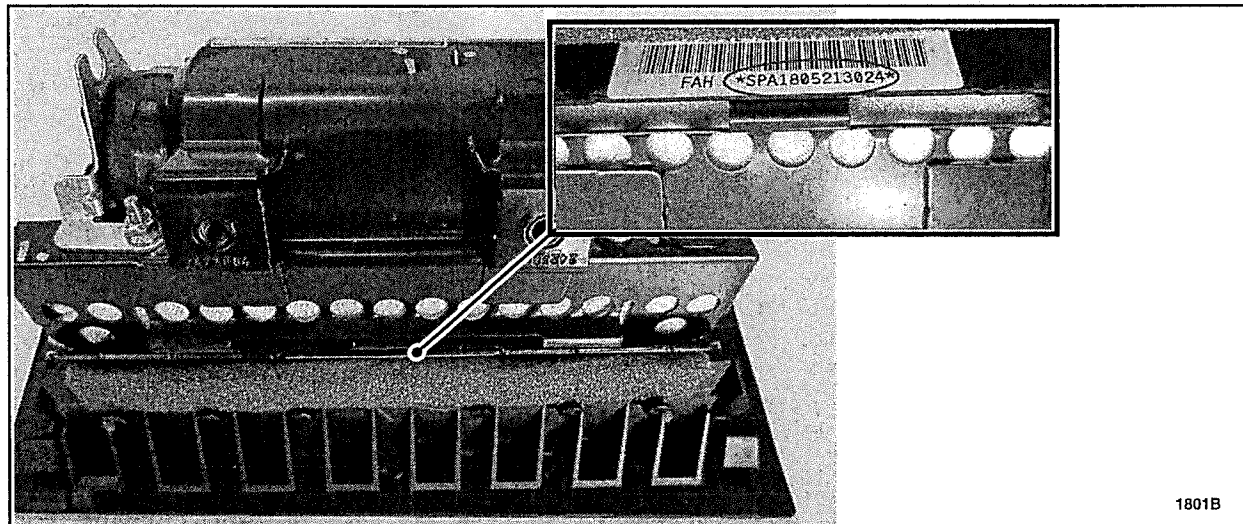

FIGURE 1



CERTAIN 2010 FUSION AND MILAN VEHICLES – PASSENGER AIRBAG MODULE REPLACEMENT

OVERVIEW

Takata has determined that the propellant wafers in some airbag inflators may experience an alteration over time, which could potentially lead to an over-aggressive combustion in the event of a crash that requires airbag deployment. This potential condition could create excessive internal pressure when the airbag is deployed, which could result in the body of the inflator rupturing upon deployment increasing the risk of injury to occupants.

Dealers are to replace the passenger airbag module. The serial number from the new airbag module must be recorded on the repair order. Place the replaced airbag module into the packaging from the new part and provide to the appropriate dealership personnel for part returns.

NOTE: For vehicles that the airbags have deployed or that have other modifications preventing the recall repair from being completed, submit a VIN-specific request to the SSSC Web Contact Site prior to attempting a repair. Attach pictures of the vehicle's airbag modules to the request.

SERVICE PROCEDURE

NOTE: The following repair instructions only apply to 2010 Fusion and Milan vehicles. Repair instructions are published in separate attachments for other vehicle lines included in this recall as parts become available for those vehicles.

NOTE: The parts used in this safety recall may physically appear to be identical, but they have differing operating characteristics. It is crucial that parts are not interchanged or substituted.

 **WARNING:** Failure to follow the instructions and warnings in the Workshop Manual (WSM) may result in injury.

NOTE: If the Airbag Readiness light indicates no Supplemental Restraint System (SRS) faults are present, it is not necessary to follow the WSM SRS Depowering and Repowering steps. Turn the ignition to OFF and wait 1 minute, then it is safe to proceed with airbag inflator replacement.

NOTE: The ignition must remain OFF until this service procedure is completed.



1. Record the 13 character serial number of the new airbag module on the repair order. See Figure 1.

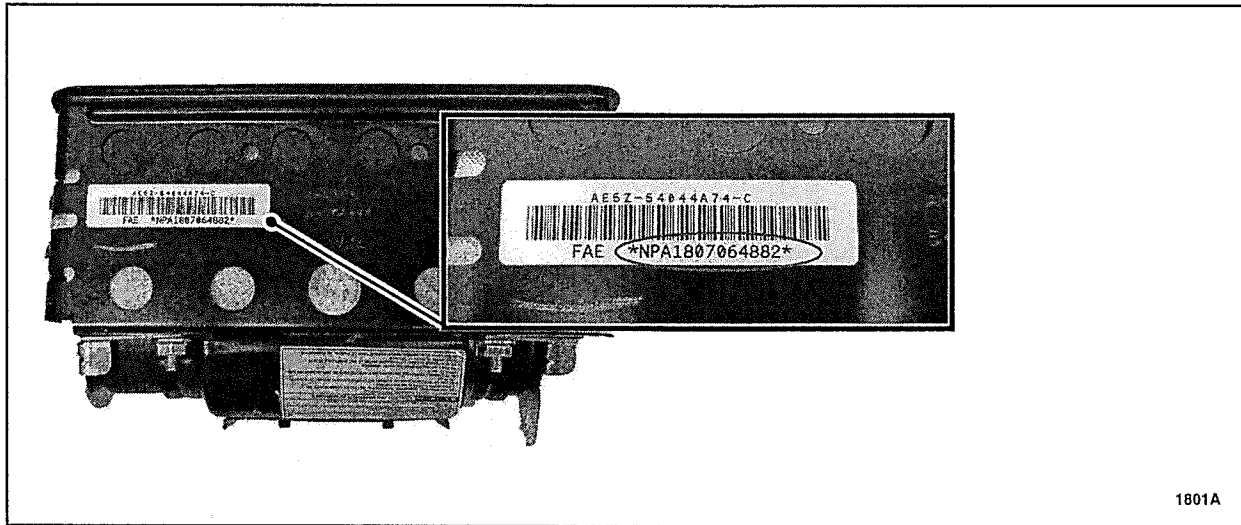



FIGURE 1

2. Remove the left hand and right hand A-Pillar trim panels. Reuse the LH and RH trim panels for this repair. See Figure 2.

- To prevent damage to the trim panel, grasp the trim panel approximately 5 inches from the top and pull downward toward the door, then rotate the panel inward toward the windshield to slide it off of the a-pillar clip.

NOTE: Do not bend or flex the trim panels during removal to avoid stress marks from occurring.

NOTE: To view a video demonstration of this repair procedure, click the video icon. 

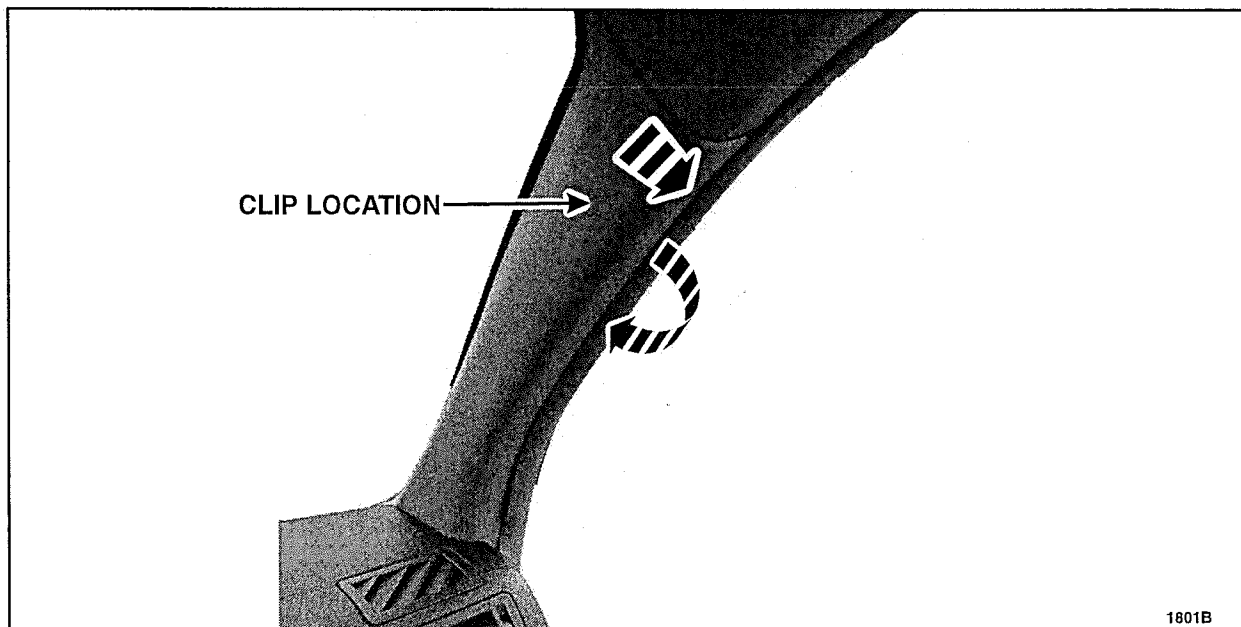

FIGURE 2



3. Remove and discard the top A-Pillar clip from the body. Retain the screw for re-use. See Figure 3.

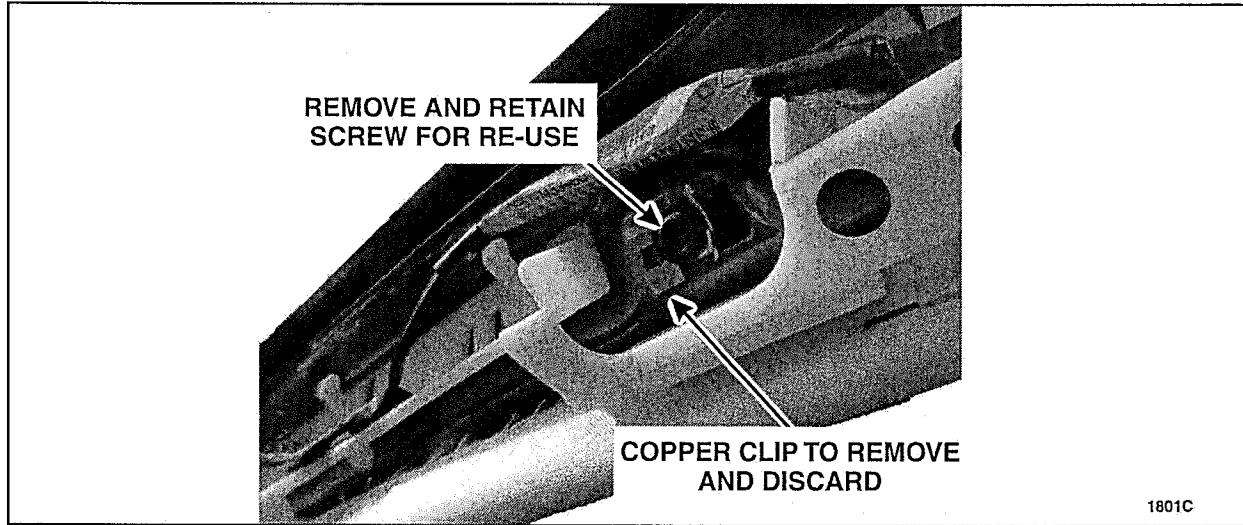

FIGURE 3

4. Remove the passenger airbag module. Please refer to Workshop Manual (WSM) procedures in section 501-20B.

- Remove the instrument panel crossmember-to-airbag module bracket. See Figure 4.
- Torque to 80 lb. in (9 Nm).

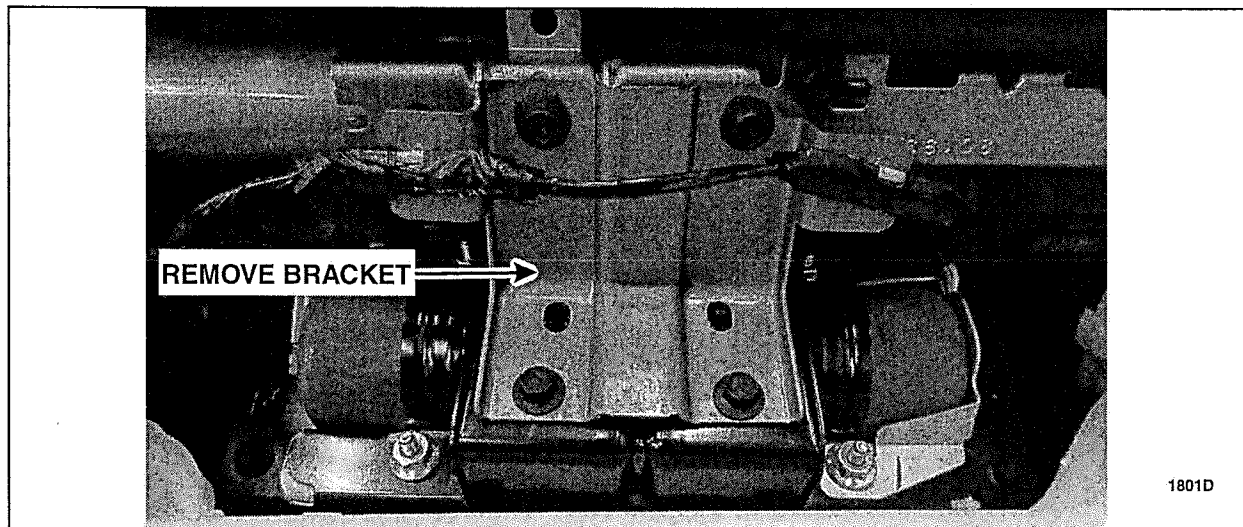

FIGURE 4



5. Remove the six nuts retaining the airbag module bracket to the instrument panel. Remove the bracket from the instrument panel. See Figure 5.

- Torque to 80 lb.in (9 Nm).

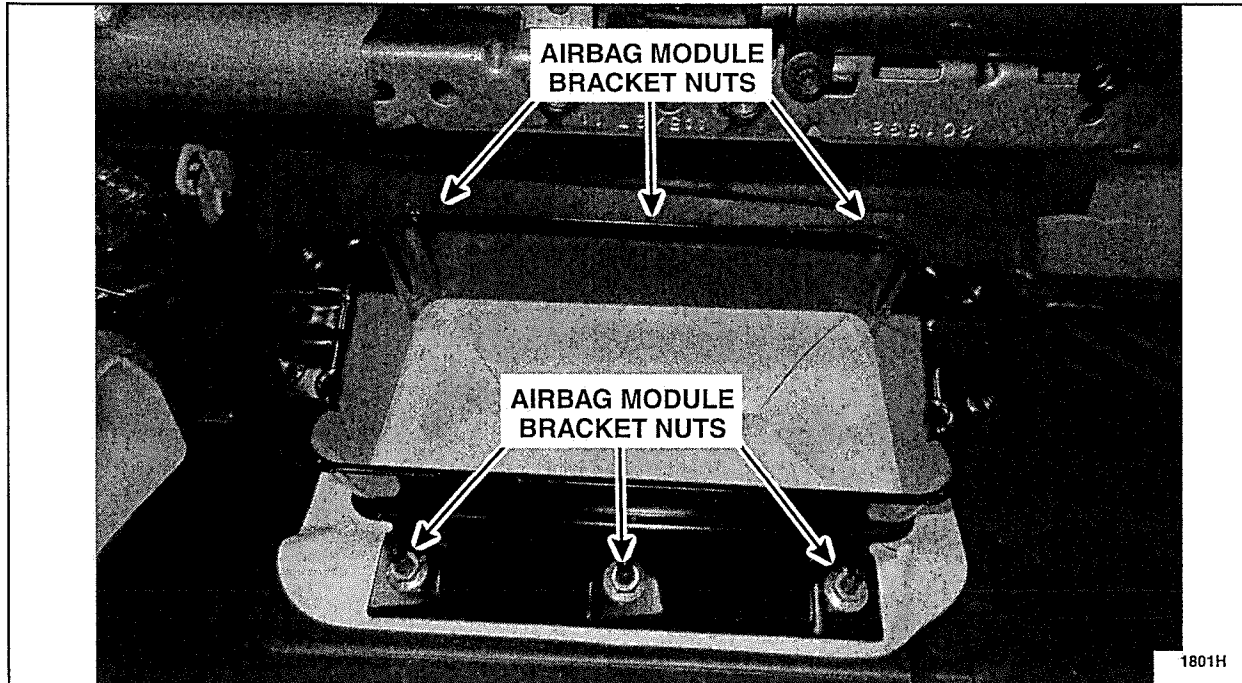

FIGURE 5



6. Inspect the white airbag cushion sheet installed on the instrument panel and the new airbag cushion sheet included with the new airbag module. See Figure 6.

NOTE: If any damage is present on the existing or new airbag cushion sheet it must be replaced. Type of damage includes, but is not limited to, cuts, creases, folds, or the perforations being broken.

NOTE: Sheets can be installed in any direction or orientation.

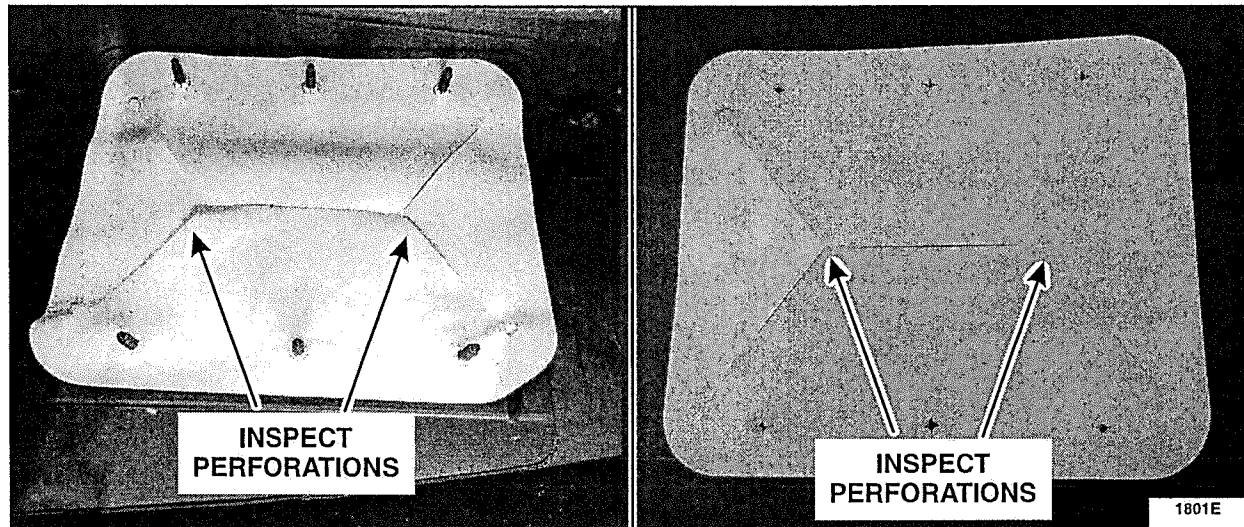

FIGURE 6



7. If no damage is found, clear both sheets of any dirt or debris and install both sheets on the airbag mounting bracket studs. See Figure 7.

NOTE: The sheets will not lay perfectly flat when installed on the instrument panel.

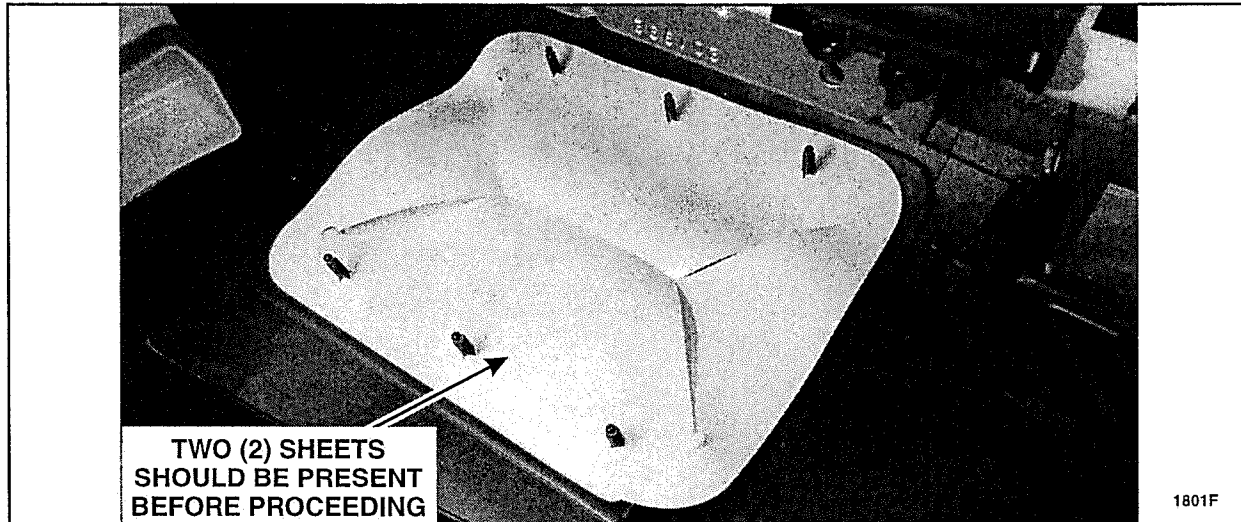

FIGURE 7

8. Reinstall the airbag module bracket onto the instrument panel. See Figure 5.
9. Install the new airbag module and instrument panel. Please follow WSM procedures in section 501-20B.
 - Install the instrument panel crossmember-to-airbag module bracket. See Figure 4.



10. Install the new A-Pillar trim panel clip onto the trim panel. See Figure 7.

NOTE: If the new A-Pillar trim panel clips are not equipped with a screw installed, re-use the screw from the original clip from step 3. Install the screw into the new clip by hand.

- Torque to 9 lb.in (1 Nm).

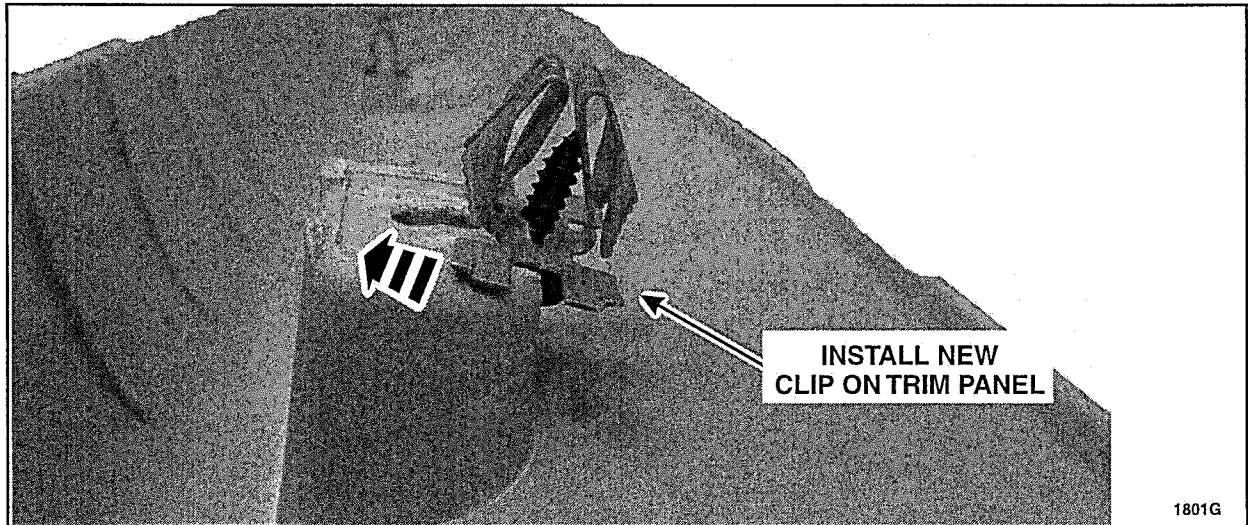

FIGURE 7

11. Install the LH and RH A-Pillar trim panels by aligning the attachment clips to the holes and snapping the new trim panel in place.
12. Package the replaced airbag module in the new part box and provide to the appropriate dealership personnel for part returns.



CERTAIN 2010 MKZ VEHICLES – PASSENGER AIRBAG MODULE REPLACEMENT

OVERVIEW

Takata has determined that the propellant wafers in some airbag inflators may experience an alteration over time, which could potentially lead to an over-aggressive combustion in the event of a crash that requires airbag deployment. This potential condition could create excessive internal pressure when the airbag is deployed, which could result in the body of the inflator rupturing upon deployment increasing the risk of injury to occupants.

Dealers are to replace the passenger airbag module. The serial number from the new airbag module must be recorded on the repair order. Place the replaced airbag module into the packaging from the new part and provide to the appropriate dealership personnel for part returns.

NOTE: For vehicles that the airbags have deployed or that have other modifications preventing the recall repair from being completed, submit a VIN-specific request to the SSSC Web Contact Site prior to attempting a repair. Attach pictures of the vehicle's airbag modules to the request.

SERVICE PROCEDURE

NOTE: The following repair instructions only apply to 2010 MKZ vehicles. Repair instructions are published in separate attachments for other vehicle lines included in this recall as parts become available for those vehicles.

NOTE: The parts used in this safety recall may physically appear to be identical, but they have differing operating characteristics. It is crucial that parts are not interchanged or substituted.

 **WARNING:** Failure to follow the instructions and warnings in the Workshop Manual (WSM) may result in injury.

NOTE: If the Airbag Readiness light indicates no Supplemental Restraint System (SRS) faults are present, it is not necessary to follow the WSM SRS Depowering and Repowering steps. Turn the ignition to OFF and wait 1 minute, then it is safe to proceed with airbag inflator replacement.

NOTE: The ignition must remain OFF until this service procedure is completed.



1. Record the 13 character serial number of the new airbag module on the repair order. See Figure 1.

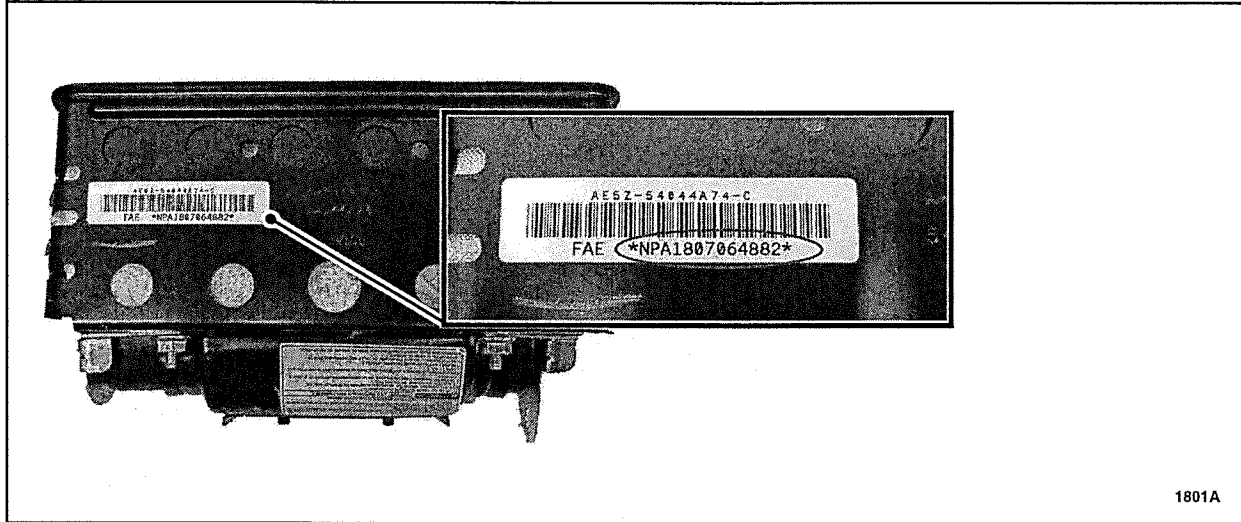



FIGURE 1

2. Remove the left hand and right hand A-Pillar trim panels. Reuse the LH and RH trim panels for this repair. See Figure 2.

- To prevent damage to the trim panel, grasp the trim panel approximately 5 inches from the top and pull downward toward the door, then rotate the panel inward toward the windshield to slide it off of the a-pillar clip.

NOTE: Do not bend or flex the trim panels during removal to avoid stress marks from occurring.

NOTE: MKZ A-Pillar trim is wrapped in fabric, be sure to protect the fabric from stains when removing.

NOTE: To view a video demonstration of this repair procedure, click the video icon. 

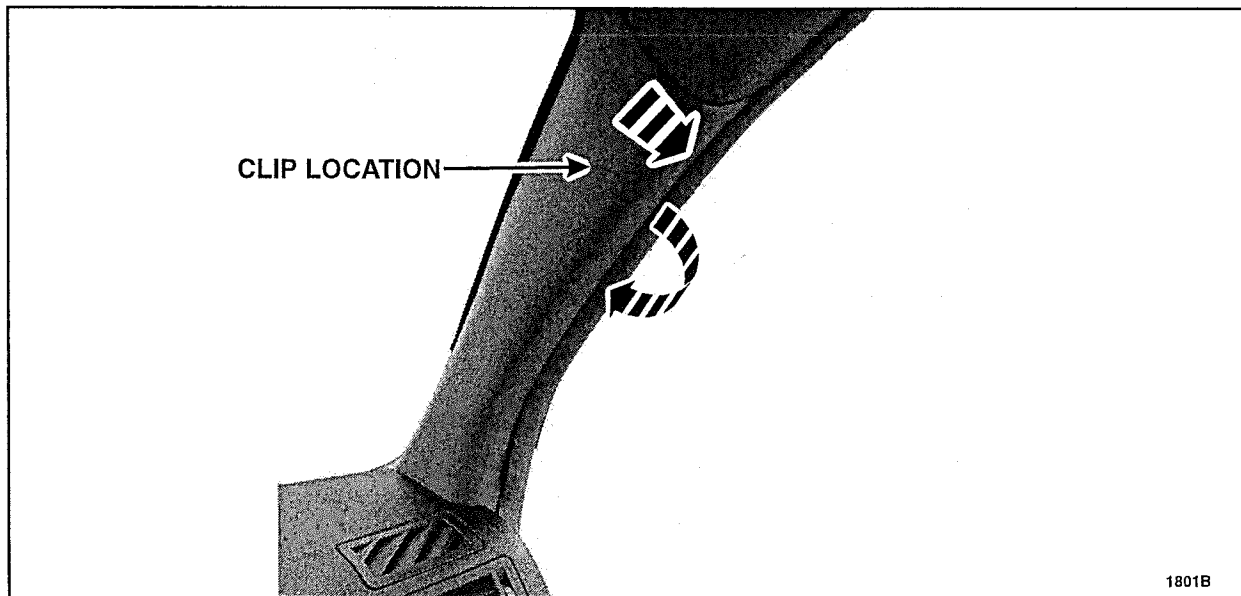

FIGURE 2



3. Remove and discard the top A-Pillar clip from the body. Retain the screw for re-use. See Figure 3.

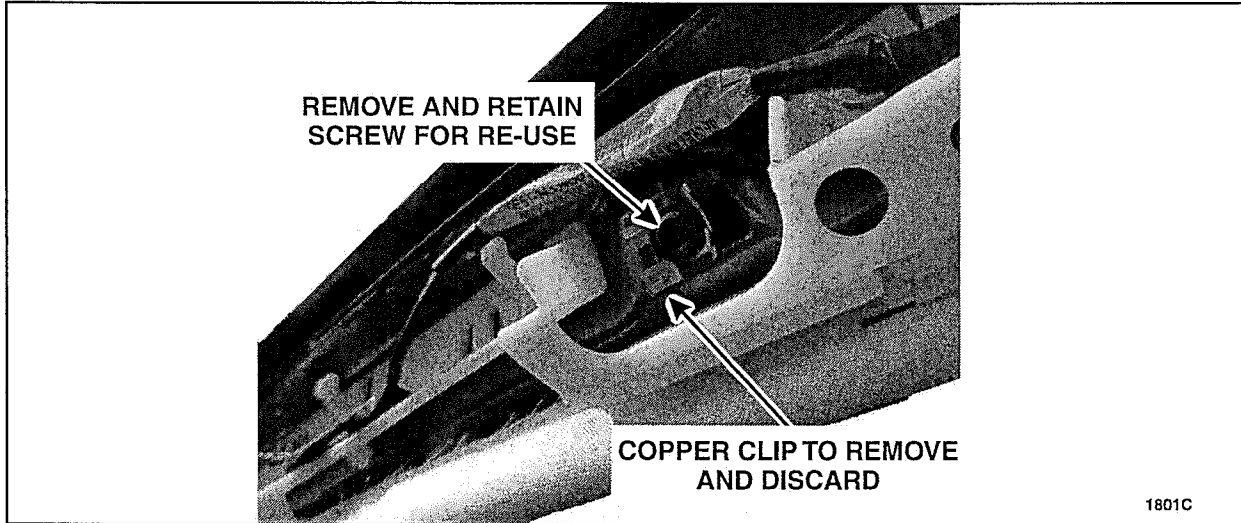

FIGURE 3

4. Remove the passenger airbag module. Please refer to Workshop Manual (WSM) procedures in section 501-20B.

- Remove the instrument panel crossmember-to-airbag module bracket. See Figure 4.
- Torque to 80 lb. in (9 Nm).

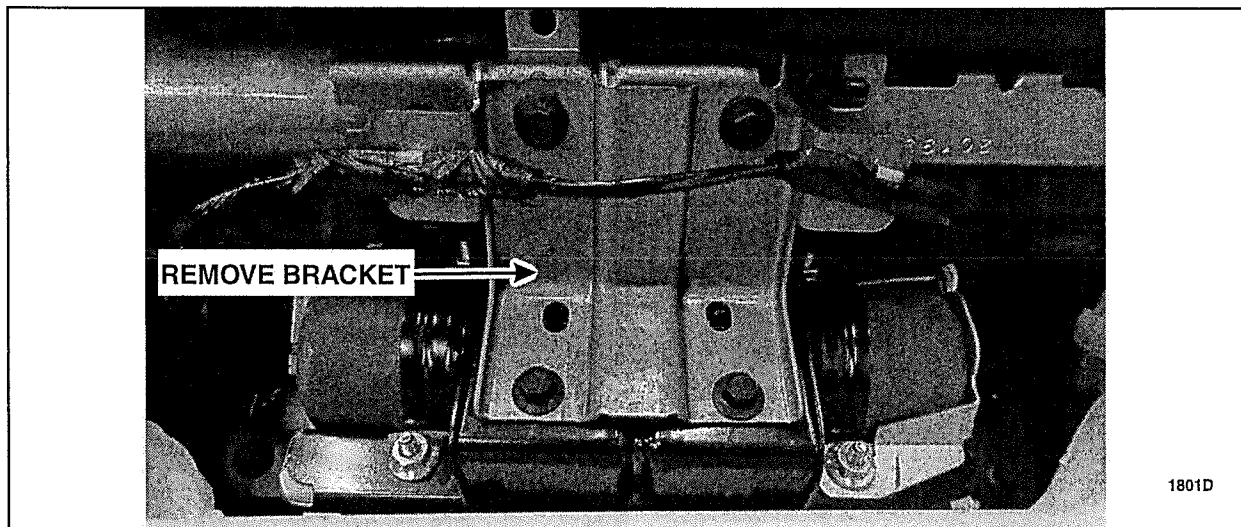

FIGURE 4



5. Install the new airbag module and instrument panel. Please follow WSM procedures in section 501-20B.

- Install the instrument panel crossmember-to-airbag module bracket. See Figure 4.

6. Install the new A-Pillar trim panel clip onto the trim panel. See Figure 5.

NOTE: If the new A-Pillar trim panel clips are not equipped with a screw installed, re-use the screw from the original clip from step 3. Install the screw into the new clip by hand.

- Torque to 9 lb.in (1 Nm).

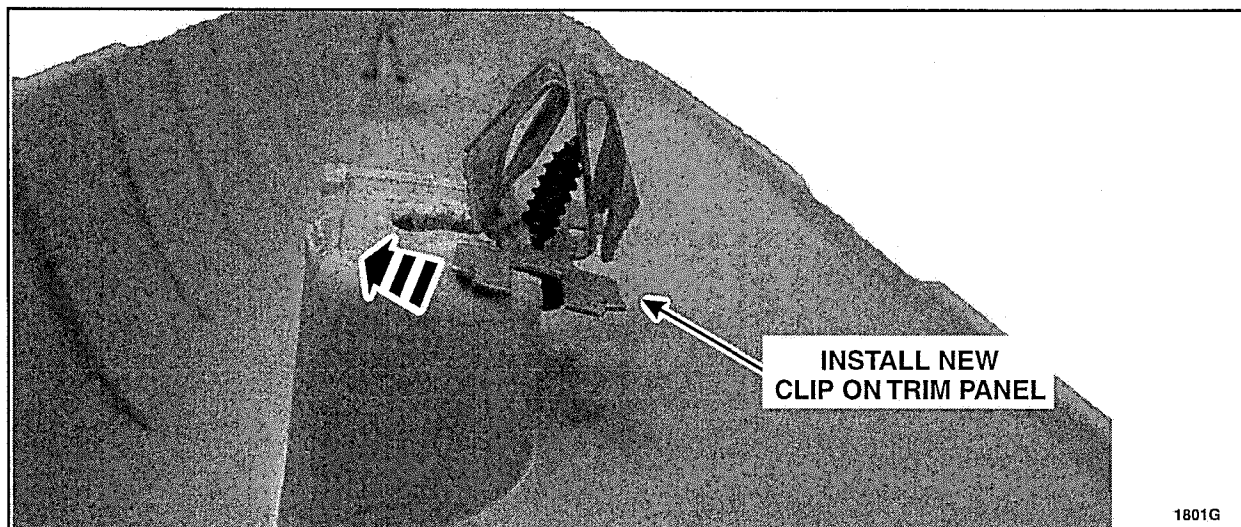

FIGURE 5

7. Install the LH and RH A-Pillar trim panels by aligning the attachment clips to the holes and snapping the new trim panel in place.
8. Package the replaced airbag module in the new part box and provide to the appropriate dealership personnel for part returns.



CERTAIN 2009 – 2010 MKX VEHICLES – PASSENGER AIRBAG MODULE REPLACEMENT

OVERVIEW

Takata has determined that the propellant wafers in some airbag inflators may experience an alteration over time, which could potentially lead to an over-aggressive combustion in the event of a crash that requires airbag deployment. This potential condition could create excessive internal pressure when the airbag is deployed, which could result in the body of the inflator rupturing upon deployment increasing the risk of injury to occupants.

Dealers are to replace the passenger airbag module. The serial number from the new airbag module must be recorded on the repair order. Place the replaced airbag module into the packaging from the new part and provide to the appropriate dealership personnel for part returns.

NOTE: For vehicles that the airbags have deployed or that have other modifications preventing the recall repair from being completed, submit a VIN specific request to the SSSC Web Contact Site prior to attempting a repair. Attach pictures of the vehicles airbag modules to the request.

SERVICE PROCEDURE

NOTE: The following repair instructions only apply to 2009 – 2010 MKX vehicles. Repair instructions are published in separate attachments for other vehicle lines included in this recall as parts become available for those vehicles.

NOTE: The parts used in this safety recall may physically appear to be identical, but they have differing operating characteristics. It is crucial that parts are not interchanged or substituted.

▲ WARNING: Failure to follow the instructions and warnings in the Workshop Manual (WSM) may result in injury.

NOTE: If the Airbag Readiness light indicates no Supplemental Restraint System (SRS) faults are present, it is not necessary to follow the WSM SRS Depowering and Repowering steps. Turn the ignition to OFF and wait 1 minute, then it is safe to proceed with airbag inflator replacement.

NOTE: The ignition must remain OFF until this service procedure is completed.



1. Record the 13 character serial number of the new airbag module on the repair order. See Figure 1.
2. Replace the passenger airbag module. Refer to section 501-20B of the Workshop Manual.
3. Package the replaced airbag module in the new part box and provide to the appropriate dealership personnel for part returns.

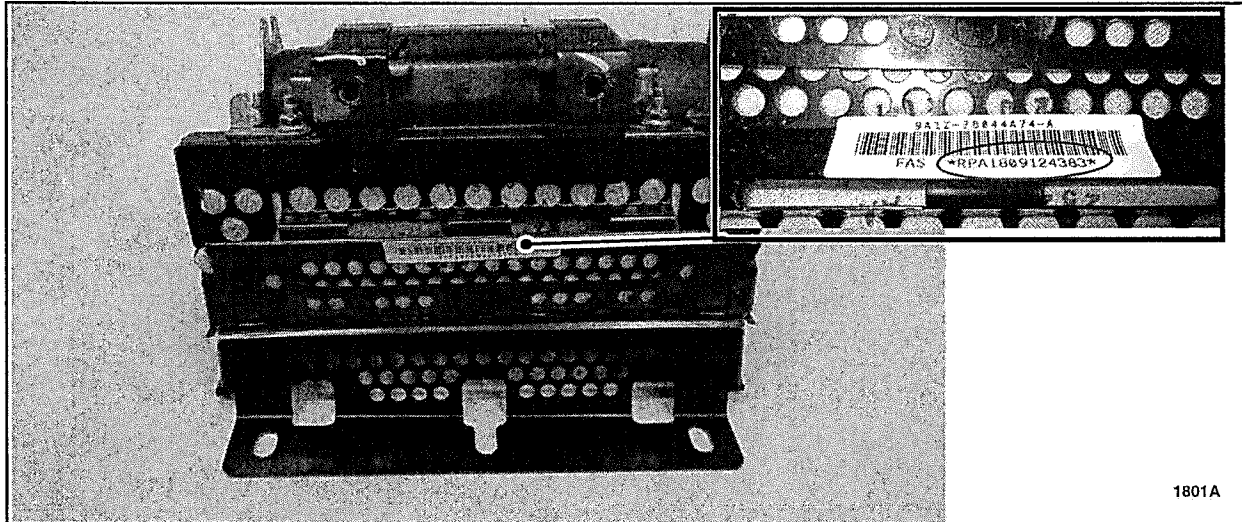

FIGURE 1



REGIONAL CORE RECOVERY CENTER AIRBAG INFLATOR RETURN PROCESS – PARTS WITH CORE CHARGES

DEALER PART RETURN INSTRUCTIONS AND SHIPPING DOCUMENTATION

Parts used under safety recall 18S01 have a core charge and will be identified as such with the yellow core label on the packaging. The Regional Core Recover Center (RCRC), including dealers in Alaska and Hawaii, will pick up these airbag inflators along with all other core returns during your normal core retrieval visit.

THE AIRBAG INFLATOR REMOVED FROM THE VEHICLE MUST BE RETURNED IN THE NEW REPLACEMENT INFLATOR PACKAGING.

- Ensure that you have processes in place to safeguard the packaging.
- The Dealer provided Haz-Mat Materials must also be returned in the packaging.
- RCRC's will not accept any airbag inflators without correct packaging or Haz-Mat documentation.
- The new replacement service part packaging is certified with the appropriate DOT marks and labels.
- Ensure that all marks and labels are present prior to tendering to the RCRC for core credit.

Airbag Inflator Haz-Mat Return Instructions

Print and provide both of the following completed documents to the RCRC driver:

1. Hazardous Materials Shipping Document (Page 2)
 - a. In the box titled Shipper, enter your dealership name and address.
 - b. In the box titled Receiver, enter the address of your Regional Core Recovery Center.
NOTE: Page 4 contains a list of RCRC locations. If you are unsure of which RCRC location serves your dealership, please consult the RCRC driver.
 - c. In the box titled **Number/Type of Package**, enter the number of boxed airbag inflators.
 - d. In the box titled **Weight**, enter the total shipment weight of all boxed airbag inflators.
 - e. At the bottom of the Hazardous Materials Shipping Document, complete the Shipper's Certification
2. North American Emergency Response Guide 171 (Page 3)

HAZARDOUS MATERIALS SHIPPING DOCUMENT – GROUND TRANSPORTATION

SHIPPER	RECEIVER
Dealership Name:	Ford Motor Company
	Regional Core Recovery Center
Address:	Address:
Phone:	Phone:
24-HOUR EMERGENCY CONTACT: INFOTRAC 1-800-535-5053 (Domestic) 1-352-323-3500 (International)	

General Instructions: Pursuant to 49 CFR each person who offers a hazardous material for transportation shall perform the following pre-transportation functions: (1) Determine the hazard class of the material (2) Select authorized hazmat packaging (3) Fill hazmat packaging (4) Properly close hazmat packaging (5) Properly mark the package (6) Properly label the package (7) Prepare shipping document (8) Provide and maintain emergency response information (9) Review shipping paper to verify compliance to 49 CFR (10) Sign shipping document to certify shipment is in conformance to 49 CFR (11) Load hazardous material in transport vehicle (12) Segregate hazardous material from incompatible cargo (13) Select, provide or affix placards to transport vehicle to indicate that it holds hazardous materials.

Also, pursuant to 49 CFR an employer must ensure any employee performing any function affecting the transport of hazardous materials must be appropriately trained for the function the employee performs and must be retrained every thirty-six months.

DOT Shipping Description		
Number/Type of Package	UN Number, Proper Shipping Name, Hazard Class, Packing Group	Weight
Box(es)	UN3268, Safety Devices, Class 9	Lbs.

Shipper's Certification (49 CFR 172.204): This is to certify that the above named materials are properly classified, described, packaged, marked and labeled and are in proper condition for transportation according to the applicable regulations of the Department of Transportation.

NAME: _____ SIGNATURE: _____ DATE: _____

<p>GUIDE SUBSTANCES (LOW TO MODERATE HAZARD) 171</p>	<p>ERG2012 SUBSTANCES (LOW TO MODERATE HAZARD) GUIDE 171</p>
<p>POTENTIAL HAZARDS</p> <p>FIRE OR EXPLOSION</p> <ul style="list-style-type: none"> • Some may burn but none ignite readily. • Containers may explode when heated. • Some may be transported hot. <p>HEALTH</p> <ul style="list-style-type: none"> • Inhalation of material may be harmful. • Contact may cause burns to skin and eyes. • Inhalation of Asbestos dust may have a damaging effect on the lungs. • Fire may produce irritating, corrosive and/or toxic gases. • Some liquids produce vapors that may cause dizziness or suffocation. • Runoff from fire control may cause pollution. <p>PUBLIC SAFETY</p> <ul style="list-style-type: none"> • CALL EMERGENCY RESPONSE Telephone Number on Shipping Paper first. If Shipping Paper not available or no answer, refer to appropriate telephone number listed on the inside back cover. • As an immediate precautionary measure, isolate spill or leak area in all directions for at least 50 meters (150 feet) for liquids and at least 25 meters (75 feet) for solids. • Keep unauthorized personnel away. • Stay upwind. <p>PROTECTIVE CLOTHING</p> <ul style="list-style-type: none"> • Wear positive pressure self-contained breathing apparatus (SCBA). • Structural firefighters' protective clothing will only provide limited protection. <p>EVACUATION</p> <p>Spill</p> <ul style="list-style-type: none"> • See Table 1 - Initial Isolation and Protective Action Distances for highlighted materials. For non-highlighted materials, increase, in the downwind direction, as necessary, the isolation distance shown under "PUBLIC SAFETY". <p>Fire</p> <ul style="list-style-type: none"> • If tank, rail car or tank truck is involved in a fire, ISOLATE for 800 meters (1/2 mile) in all directions; also, consider initial evacuation for 800 meters (1/2 mile) in all directions. 	<p>EMERGENCY RESPONSE</p> <p>FIRE</p> <p>Small Fire</p> <ul style="list-style-type: none"> • Dry chemical, CO₂ water spray or regular foam. <p>Large Fire</p> <ul style="list-style-type: none"> • Water spray, fog or regular foam. • Do not scatter spilled material with high pressure water streams. • Move containers from fire area if you can do it without risk. • Dike fire-control water for later disposal. <p>Fire Involving Tanks</p> <ul style="list-style-type: none"> • Cool containers with flooding quantities of water until well after fire is out. • Withdraw immediately in case of rising sound from venting safety devices or discoloration of tank. • ALWAYS stay away from tanks engulfed in fire. <p>SPILL OR LEAK</p> <ul style="list-style-type: none"> • Do not touch or walk through spilled material. • Stop leak if you can do it without risk. • Prevent dust cloud. • Avoid inhalation of asbestos dust. <p>Small Dry Spill</p> <ul style="list-style-type: none"> • With clean shovel place material into clean, dry container and cover loosely; move containers from spill area. <p>Small Spill disposal</p> <ul style="list-style-type: none"> • Take up with sand or other non-combustible absorbent material and place into containers for later disposal. <p>Large Spill</p> <ul style="list-style-type: none"> • Dike far ahead of liquid spill for later disposal. • Cover powder spill with plastic sheet or tarp to minimize spreading. • Prevent entry into waterways, sewers, basements or confined areas. <p>FIRST AID</p> <ul style="list-style-type: none"> • Move victim to fresh air. • Call 911 or emergency medical service. • Give artificial respiration if victim is not breathing. • Administer oxygen if breathing is difficult. • Remove and isolate contaminated clothing and shoes. • In case of contact with substance, immediately flush skin or eyes with running water for at least 20 minutes. • Ensure that medical personnel are aware of the material(s) involved and take precautions to protect themselves.
<p>ERG2012</p>	<p>Page 280</p>

RCRC Locations					
RCRC CODE	Parent	Address	City	State	Zip
00708	HPD	2511 Lovi Rd B/L 3/3A	FREEDOM	PA	15042
01183	HPD	20501 PENNSYLVANIA ROAD STE 140	BROWNSTOWN	MI	48192
01326	HPD	9040 BURROUGH DOVER LANE	PENNSAUKEN	NJ	08110
01615	AER	144 MAKAAALA ST	HILO	HI	96720
01728	AER	1123 Buffalo Run	Missouri City	TX	77489
01729	AER	5915 CORRIDOR PARKWAY	SCHERTZ	TX	78154
02276	AER	4300 Round Lake Rd. W. Unit 200	ARDEN HILLS	MN	55112
02454	AER	1605 SURVEYOR BLVD.	CARROLLTON	TX	75006
03001	AER	8333 WASHINGTON PL NE Suite E	ALBUQUERQUE	NM	87113
03199	AER	7103 E. 47TH AVE. Dr.	DENVER	CO	80216
03956	FMP	300 Calais Dr STE #1	ANCHORAGE	AK	99503
04861	AER	5503 F ST	OMAHA	NE	68117
05399	FJ	1002 South 56th Ave	PHOENIX	AZ	85043
05495	AER	4161 DIXON AVE	DES MONIES	IA	50313
05514	HPD	3645 DEVELOPERS RD.	INDIANAPOLIS	IN	46227
06201	FJ	1040 S Rockefeller	Ontario	CA	91761
06583	AER	600 South Theresa Ave.	ST LOUIS	MO	63103
06586	FJ	11515 Granite St	CHARLOTTE	NC	28273
06615	HPD	8242 SANDY COURT	JESSUP	MD	20794
06952	FJ	7145 INDUSTRIAL	EL PASO	TX	79915
06953	FJ	550 Gills Drive	ORLANDO	FL	32824
06954	FJ	5286 Georgia Hwy 85, Suite 200	FOREST PARK	GA	30297
06955	FJ	545 Ford Avenue	JACKSON	MS	39209
06959	FJ	6200 SW 29th Ste A	OKLAHOMA CITY	OK	73179
07089	FJ	4304 Eubank Road	RICHMOND	VA	23231
07748	AER	1049 KIKOWAENA PLACE	HONOLULU	HI	96819
07953	AER	231 PAPA ST.	KAHULUI	HI	96732
08263	AER	11 Chapin Road, Unit A	PINE BROOK	NJ	07058
08453	AER	18637 72nd Ave S	KENT	WA	98032
08454	AER	5220 N. E. 152ND PLACE	PORTLAND	OR	97230
08587	AER	2999 MILLER STREET	SAN LEANDRO	CA	94577
08731	AER	8250 NE Underground Dr. Pillar 153	KANSAS CITY	MO	64161
08858	AER	2233 S. 1800 WEST	WEST VALLEY	UT	84119
09001	AER	3311 CORPORATE DR	JOLIET	IL	60431
09121	HPD	444 WHITNEY ST	NORTHBOROUGH	MA	01532
09252	HPD	1901 LEMOYNE AVE.	SYRACUSE	NY	13208

Safety Recall 18S01

Certain 2009-2010 and 2013 Mustang, 2009-2010 Ranger, 2009-2010 Fusion and Milan, 2009-2010 MKZ, and 2009-2010 Edge and MKX Vehicles
Passenger Airbag Inflator Replacement

DEALER Q & A**Q1. How will I know when parts are available for other vehicles affected by this recall?**

- A. Dealers are encouraged to refer to the Takata Airbag Inflator Recall Information for Dealers document on the FMC dealer homepage for the latest parts status for all Takata airbag recalls. The dealer bulletin will also be updated as repair information becomes available for other affected vehicles.

Q2. Why is it taking so long to get parts for this recall?

- A. To support this recall new parts had to be designed and rigorously tested. In addition, multiple vehicle manufacturers are affected by the Takata airbag inflator recalls and use the same suppliers for replacement recall parts. This has caused a high demand for airbag inflator parts industry wide.

Q3. Are rental vehicles available for customers?

- A. Yes, if a customer requests a rental vehicle. Refer to the Takata Airbag Recall Rental Vehicle Policy attachment for full details.

Q5. Why is a core charge applied to the parts for this program when that has not been the case on previous Takata recalls?

- A. This is an effort to make it easier to do business with Ford and reduce the amount of paperwork required for dealers.

NOTE: All previously published Takata safety recalls will continue to use the FCS-700 tag process (15S21, 17S42 and 18S02).

Q6. A vehicle on my dealer's FSA VIN list has deployed, modified, or missing airbags. Can the vehicle be removed from my dealers FSA VIN list?

- A. Vehicles that have deployed, missing, or modified airbags need to be reviewed by the Special Service Support Center (SSSC) to ensure the potential risk for airbag inflator rupture is no longer present. Dealers should submit a VIN-specific web contact request to the SSSC with pictures showing the airbag's state and vehicle's VIN plate so a determination can be made.

Q7. Can my Dealership use Quick Lane bays and Technicians to complete this recall?

- A. At the dealer's discretion, dealers with Quick Lanes may now use Quick Lane service bays and Quick Lane technicians to perform Takata Airbag Recalls **ONLY**.
- Claim processing, hazardous material handling and parts returns **MUST** be processed through the main dealership's warranty submission process and parts department.
 - Quick Lanes are authorized to perform Takata Airbag Recalls **ONLY**. **NO** other warranty or recall repairs are allowed at Quick Lanes at this time.

Safety Recall 18S01

Certain 2009-2010 and 2013 Mustang, 2009-2010 Ranger, 2009-2010 Fusion and Milan, 2009-2010 MKZ, and 2009-2010 Edge and MKX Vehicles
Passenger Airbag Inflator Replacement

Q8. Will completed surveys count towards my Customer Viewpoint (CVP) score? Are the scores included in my Ford Commitment Plan (FCP) calculations?

A. A majority of the vehicles affected by this recall are over the 5 years/75,000 scoring criteria which makes them ineligible for CVP Score and FCP calculations. If a vehicle is within the 5/75 criteria the completed surveys will be included in CVP/FCP scores.

QUESTIONS & ASSISTANCE

For additional questions and assistance, contact the Special Service Support Center (SSSC) via the SSSC Web Contact Site. The SSSC Web Contact Site can be accessed through the Professional Technician Society (PTS) website using the SSSC link listed at the bottom of the OASIS VIN report screen or listed under the SSSC tab.

TAKATA AIRBAG RECALL RENTAL VEHICLE POLICY

This rental vehicle policy only applies to the Takata airbag recalls 15S21, 16S26, 17S01, 17S42, 18S01, and 18S02.

New! RENTAL POLICY OVERVIEW

NOTE: Due to increased parts availability, effective December 24, 2018, no additional long-term rentals will be approved. Back-dated rental approvals will not be approved effective December 17, 2018. Refer to the Dealer Bulletin for details.

Short-term rentals will remain available if a customer requests a rental vehicle while their vehicle is being repaired. The short-term rental vehicle program is an effort to make it easier for customers to have this recall repair completed and should only be offered when a customer requests a rental vehicle. Rental vehicles must not be used to help manage service department scheduling.

If a customer requests a rental vehicle while their vehicle is being repaired, refer to the flow chart on the last page of this attachment for the process for requesting rental vehicle reimbursement. Dealers must:

- order required parts prior to a customer's appointment.
- retain customers' vehicles until the recall repair is completed and the rental vehicle is returned.
- notify the customer the same day that the repair is completed on their vehicle and request that they promptly return the rental vehicle. Rentals exceeding 7 days from the date the customer is notified that their vehicle is repaired, will not be reimbursed.

If the customer has paid for a rental vehicle or alternative transportation for the purpose of this recall, they are eligible for reimbursement within the guidelines outlined in the Takata Airbag Recall Rental Vehicle Policy. Dealers must follow the same process for claiming rental vehicle reimbursement and then refund the customer.

RENTAL VEHICLE SOURCE

Rental vehicles may be supplied through dealership owned rental units, the Ford Courtesy Transportation Program, Ford Rent-A-Car, Lincoln Rent-A-Car, or third party rental agencies. If a customer has reserved a rental vehicle on their own or with the assistance of the Customer Relationship Center, the same rental guidelines and processes for requesting reimbursement apply.

VEHICLE MAKE AND MODEL YEAR REQUIREMENTS

While it is a preference to put Ford customers in Ford rental vehicles and Lincoln customers in Lincoln rental vehicles, this is not always possible and is not a requirement for rental reimbursement under the Takata airbag recalls. Due to varying rental vehicle agency make and model inventory, Ford and Lincoln vehicles may not always be available so it is acceptable to use other make rental vehicles. There are no model year requirements for rental vehicle reimbursement.

RENTAL REIMBURSEMENT GUIDELINES / NATIONAL TAKATA RECALL RENTAL AGREEMENT

The following table lists the maximum per day and per month dollar amounts that will be reimbursed under this policy. In some cases, the cost per day limit may not be sufficient to cover all of the costs associated with a rental vehicle. It is the customer's responsibility to cover any additional costs above the cost per day and per month limits. If there is a unique customer circumstance that requires a rental vehicle with a higher per day/month allowance, dealers should submit a VIN specific request to the Special Service Support Center (SSSC) for special consideration.

Make of Recalled Vehicle	Rental Vehicle Reimbursement Cost Per Day Limit	Rental Vehicle Reimbursement Cost Per Month Limit
Ford	\$44 (including tax)	\$1,320 (including tax)
Mercury	\$44 (including tax)	\$1,320 (including tax)
Lincoln	\$55 (including tax)	\$1,650 (including tax)

To make it easier for dealers to locate vehicles within the rental vehicle reimbursement limits, Ford has established an agreement with Enterprise Rent-A-Car, Avis Budget Group, and Hertz to provide rental vehicles for customers affected by the Takata airbag recalls within the reimbursement limits listed above including tax. The only exclusion being the \$55 per day rate for Lincoln customers, which has only been agreed upon by Enterprise Rent-A-Car and Hertz.

- For Enterprise Rent-A-Car, Avis Budget Group, and Hertz, rental rates charged will be based on the make of the vehicle covered under the recall, rather than the type of vehicle rented to the customer (i.e. \$44 per day for Ford and Mercury owners and \$55 per day for Lincoln owners).
- If a customer decides to rent a specialty vehicle such as a large SUV that is in excess of the cost per day/month reimbursement limits, the additional cost beyond the approved rate for the vehicle rented will be the customer's responsibility to pay.
- Enterprise Rent-A-Car, Avis Budget Group, and Hertz do not guarantee that a Ford or Lincoln vehicle will be rented to all customers that own or request such vehicles.
- Regardless of a dealer's tax status Enterprise Rent-A-Car, Avis Budget Group, and Hertz will bill dealers at the rates listed above.
- The rates listed above may not be available at airport locations.
- Ford does not endorse any particular rental vehicle provider.

ENTERPRISE AUTOMATED RENTAL MANAGEMENT SYSTEM

If renting from Enterprise Rent-A-Car dealers are encouraged to schedule reservations through Enterprise's free Automated Rental Management System (ARMS®).

The ARMS® benefits to dealers are as follows:

- The ability to create and submit "real time" rental reservations online or through your CDK® or Reynolds & Reynolds® Dealership Management System to the local Enterprise branch.
- Reservations can be made same day or submitted in advance with anticipation of rental needs.
- Specific rental needs can be communicated in the reservation (e.g. full-size SUV desired, etc.).
- Authorize additional rental days when necessary.
- View and print rental invoices online, immediately after each rental event is completed.

EXPENSES NOT COVERED UNDER RENTAL VEHICLE REIMBURSEMENT

Rental Vehicle Reimbursement does not cover the following expenses:

- Mileage charges
- Fuel charges
- Underage driver surcharge
- Insurance
- One way fees

NOTE: Some car insurance policies include rental vehicle insurance coverage so the purchase of additional insurance may not be required.

RENTAL VEHICLE DOCUMENTATION

Rental vehicle documentation must include the following:

- A rental invoice from a dealership or commercial rental agency
- Contract holder's name on the rental invoice
- Daily rental rate
- Proof of payment (for customer refund of rental)

ADMINISTRATIVE ALLOWANCE

Dealers are only eligible to claim a \$25 administrative fee for:

- Any rental claims under long-term rental program 18A01, 18A02, 18A03, or 18A04 that were submitted after June 13, 2018. This includes long-term rental claims that were originally approved by the SSSC after May 12, 2018 but processed for warranty payment after June 13, 2018.
- Any rental claims with an RO open date after September 23, 2018 that require more than 4 rental days.

CUSTOMER WAITLIST

Dealers with customers on a waitlist for a rental vehicle are encouraged to work with their rental vehicle provider of choice. In most cases if a rental vehicle is not immediately available, rental vehicle providers are able to provide one to customers within 24 hours.

If using Ford Courtesy Transportation Program (FCTP) for rentals, dealers should contact their sales operations manager for consideration for additional FCTP units.

YOUTHFUL RENTER SURCHARGE

Drivers under the age of 25 may be subject to a youthful renter surcharge and additional insurance requirements. These additional fees are not eligible for rental vehicle reimbursement unless they fall within the cost per day/month limits. Youthful renter policies vary by rental vehicle provider and location. Contact the rental vehicle provider that the vehicle is being rented from for further details.

INCREASED FORD COURTESY TRANSPORTATION PROGRAM (FCTP) GUIDES

In order to support these customers, FCTP Program Headquarters will review increased guides requests above the existing maximum on a case by case basis to ensure coverage is sufficient. Dealers must submit their request to their sales operations manager in order to be considered.

RENTAL VEHICLES PAID BY CUSTOMERS

If a customer has obtained a rental vehicle on their own that is within the guidelines of this policy, they are eligible for a refund. The customer must provide the dealer with the rental documentation necessary to request rental reimbursement. Dealers must then follow the rental vehicle reimbursement process and provide a refund to the customer. Amounts above the cost per day/month limits will not be reimbursed.

ALTERNATIVE TRANSPORTATION

If a customer is unable or does not wish to rent a vehicle but still requires transportation, the rental reimbursement allowance can be used for alternative transportation. The same cost per day limits apply of \$44 per day for Ford and Mercury customers and \$55 per day for Lincoln customers. The dollar per day allowance can be cumulative across multiple rides per day (e.g. ride to work \$20 and ride home \$24).

- Any amount in excess of the cost per day limits will be the customer's responsibility.
- The customer will need to pay up front and provide proof of payment to the dealer.
- Dealers will then need to submit for reimbursement following the Rental Vehicle Reimbursement Process and then refund the customer.

Examples of alternative transportation:

- Taxi
- Public Transportation - Subway, Train, or Bus
- Rideshare alternatives (Chariot, Uber, Lyft, etc.)

STORAGE OF CUSTOMERS VEHICLES

For all new rental requests, dealers should retain customers' vehicles until the recall repair is completed and the rental vehicle is returned. This will allow for the vehicle to be repaired as soon as the part arrives and for the rental vehicle to be promptly returned. Due to the vehicle storage duration only anticipated to be short term, a vehicle storage/upkeep allowance will not be provided to dealers under this program.

Customers that were previously advised to retain and store their vehicles should drop their vehicles off at their dealer so the vehicle can be repaired as soon as the part arrives. The Customer Relationship Center will be contacting customers currently in long-term rental vehicles to advise them to drop off their recalled vehicle at the dealer so the repair can be made as soon as the part arrives. Customers will be responsible for all vehicle upkeep during the time the vehicle is being stored.

RESTRICTED VEHICLE USE AGREEMENT

The Restricted Vehicle Use Agreement is no longer required for new rental requests due to the recalled vehicle remaining at the dealership until repaired.

TAKATA AIRBAG RECALL RENTAL VEHICLE PROCESS

