

Revisions to this document are noted  
by a stripe in the left-hand margin

2018FA07, Rev. A  
August, 2018  
Page 1 of 8

SUBJECT: H 40/50 EP™ Drive Unit C1/C2 Pressure Switch

MODELS AFFECTED: H 40/50 EP™ Drive Unit

### Introduction:

Allison Transmission, Inc. (ATI) has identified an issue with the pressure switch (P/N 29506484) used in a specific population of H 40/50 EP Drive Units™. The Drive Units, within the serial number range specified below, were built with pressure switches that can fail in an either open or closed state. The failure can cause diagnostic trouble codes (DTCs) to set which may disable the corresponding clutch, locking the Drive Unit into the unaffected range with reduced performance, or disable propulsion. Additionally, a subset population of Drive Units within the same serial number range may have debris in valve bodies or internal passages that could prevent proper valve operation. The purpose of this Field Action is to proactively replace the two (2) pressure switches used in each of the affected Drive Units, and inspect and remove debris in the subset population according to the procedure included in this Field Action.

Prior to working on vehicles, please read SIL 21-TR-18, Defective Normally Open Pressure Switch P/N 29506484, for parts information. All replacement pressure switches installed in the affected Drive Unit serial number ranges must be stamped with a date code of 1918 or later.

### Serial Number Range:

The serial number range included in this Field Action is 7110008855 through 7110009446. All serial numbers in this range will require the two (2) pressure switches to be replaced.

The serial numbers of the subset population requiring the additional debris inspection and removal are 7110009294 through 7110009445.

### Repair Process Overview:

All buses equipped with a Drive Unit serial number 7110008855 through 7110009446 will need to have the oil drained into a clean container for reuse. The oil pan will be removed and the two (2) pressure switches replaced. Refer to Allison Electric Drives Service Manual SM3602 Section 5-12 for pan removal and Section 6-15, C1/C2 Relay Valve Body, for switch replacement.

For buses equipped with a Drive Unit serial number 7110009293 through 7110009445, valve bodies will need removed, inspected for debris, and compressed air blown through the C1 and C2 pressure taps in the rear cover to remove any potential debris, followed by pressure switch replacement. Instructions for Drive Unit serial numbers 7110009293 through 7110009445 are provided at the end of this document. Refer to Allison Electric Drives Service Manual SM3602 Sections 5-13 through 5-17 for disassembly and Sections 6-13 through 6-15 for installation.

**Table 1. ATI Required Service Parts**

Part Description	Part Number	Quantity Per Bus
Pressure Switch, N/O	29506484	2
O-Ring, Switch	29501439	2
Gasket, Oil Pan	29538847	1
O-Ring, Drain Plug	23019664	1
O-Ring, Filter	23018950	1

**Claim Submittal Information:**

**Table 2. Claim Information**

Claim Type	04
Special Activity Indicator	2018FA07
Primary Failed Part	29506484
Complaint Code	AT02
Failure Code	CC03

**Table 3. Labor Codes**

Labor Code	Labor Hours	Labor Operation
00094100	0.5	R&R Oil Pan and Fluid
00096100	0.2	Switch Replacement
00094700	2.8	Debris Inspection
00096400	0.5	Final Test Drive

Any additional parts, labor, net items, or travel costs deemed necessary to complete this Field Action must be described in detail in the claim narrative. Unexplained costs will be deducted from the claim.

Authorized Allison service outlets must follow the published Allison Transmission current labor time guide for work performed when adding any additional charges.

**Procedure for Inspection and Removal of Debris:**

1. With the Drive Unit installed, drain the fluid into a clean container for reuse, and drop the oil pan from the Drive Unit.

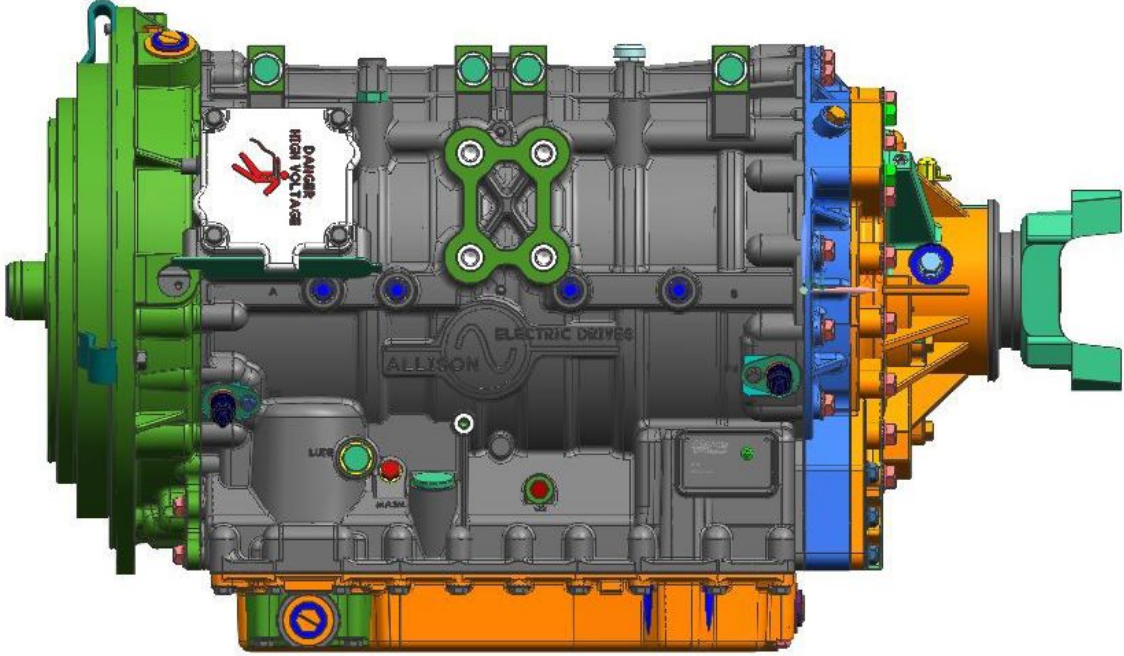

**Figure 1.**

4268066

2. Remove the suction filter and unplug all connectors on the internal harness.

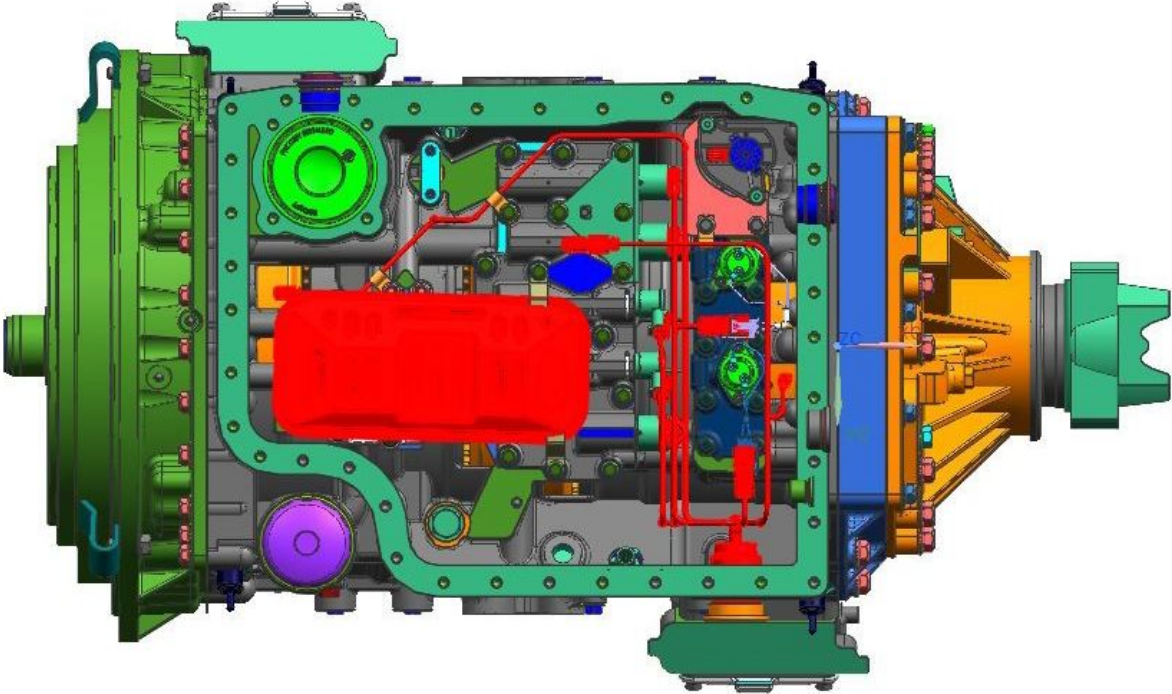

4268156

Figure 2.

- 3. Remove the oil level sensor, C1/C2 valve body, shift relay valve body, control main valve body, and separator plate.

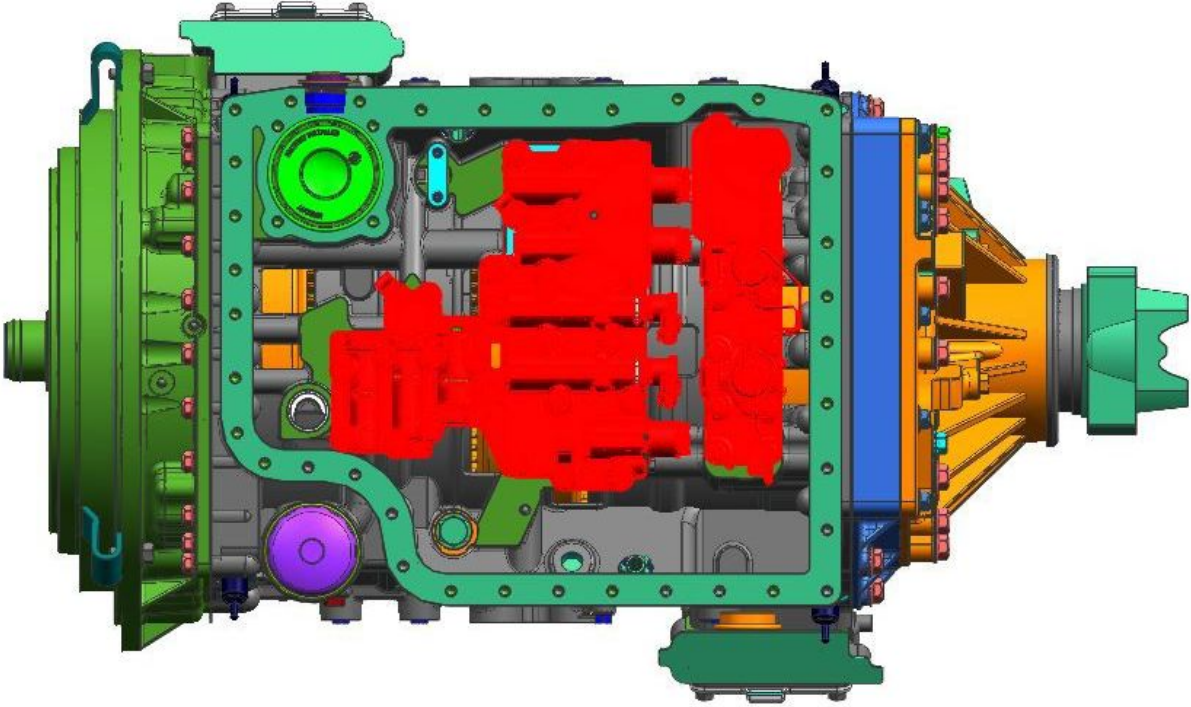

4268266

Figure 3.

4. Remove the C1 and C2 plugs (shown below) on the backside of the rear cover.

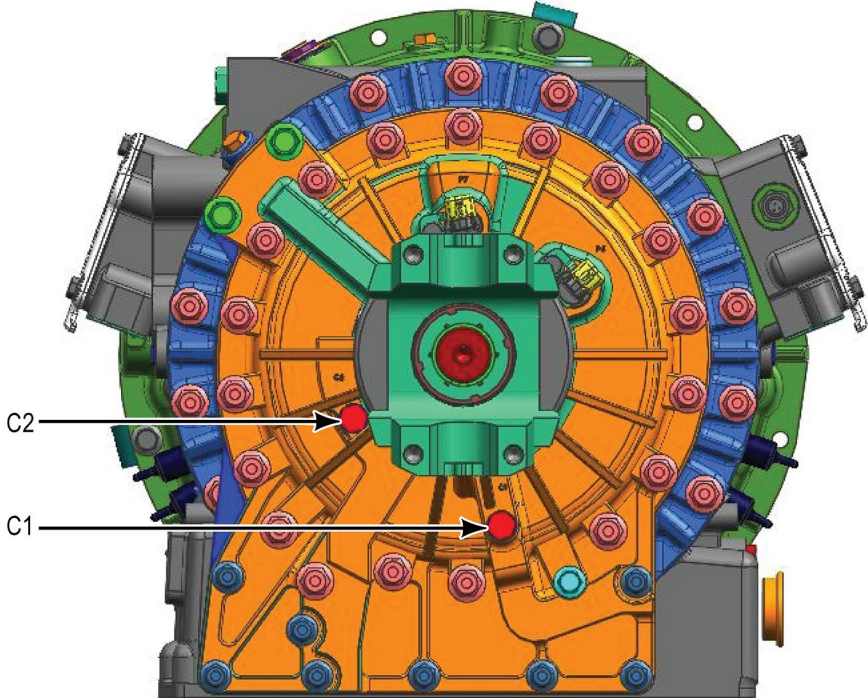

4268366

Figure 4.

5. Starting with the C2 pressure circuit, plug the 4mm orifice on the stator housing, as shown below. Pressurize the C2 pressure tap on the rear cover with air to blow out any debris. Check the previously plugged 4mm passage for loose debris and remove if any is found.

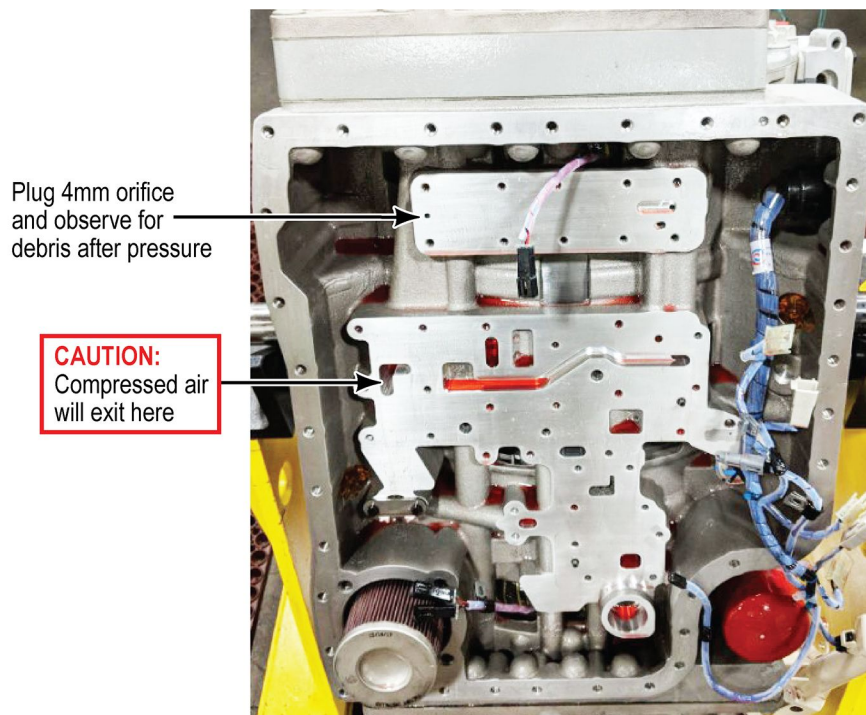
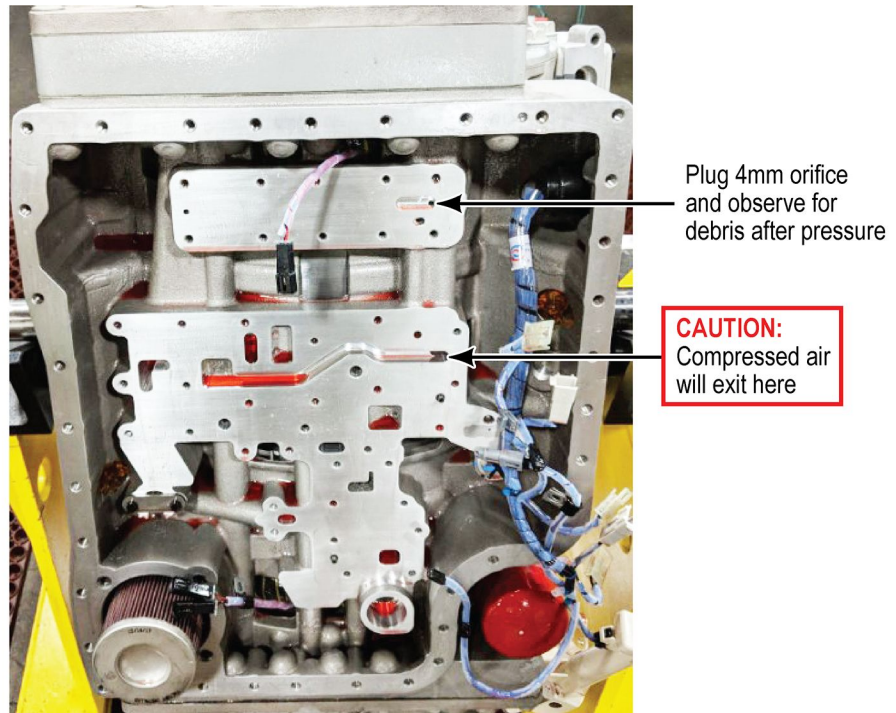

Figure 5.

4268486

- To inspect the C1 pressure circuit, plug the 4mm orifice on the opposite side the stator housing, as shown below. Pressurize the C1 pressure tap on the rear cover with air to blow out any debris. Check the previously plugged 4mm passage for loose debris and remove if any is found.



4268586

**Figure 6.**

- Inspect the removed valve bodies and the separator plate for any machine chips or debris. Verify proper valve movement. If any debris is found, additional valve body teardown should be performed. Replace any components that may have damage.
- Reassemble the valve bodies and install two (2) new pressure switches (P/N 29506484) and O-rings (P/N 29501439). New switches must be stamped with date code 1918 or later on the metal retainer ring.

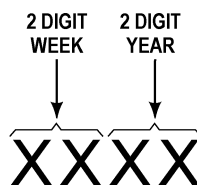

**Figure 7. Date Code Format**

- Reassemble remaining parts, refill the Drive Unit, and test drive to verify proper operation.

Copyright © 2018 Allison Transmission, Inc. All Rights Reserved.