



Michael A. Berardi  
 Director  
 Service Engineering Operations  
 Ford Customer Service Division

Ford Motor Company  
 P. O. Box 1904  
 Dearborn, Michigan 48121

August 2, 2017

**TO:** All U.S. Ford and Lincoln Dealers

**SUBJECT: NEW VEHICLE DEMONSTRATION / DELIVERY HOLD - Safety Recall 17S15  
 – Supplement #3**

Certain 2015-2017 Transit Vehicles Equipped with a Driveshaft Flexible Coupling  
 Driveshaft Flexible Coupling Repair

**New! REASON FOR THIS SUPPLEMENT**

- **Parts Requirements / Ordering Information:** *The parts information table for certain 148 wheelbase vehicles has been updated. Ford will order the updated part on August 2, 2017 for all orders previously submitted by the SSSC. New VIN-specific Part Order contacts will not be required for previously ordered parts.*
- *All VINs submitted to the SSSC on or after August 2, 2017 will have the updated part ordered.*
- *To return excess parts, follow existing process under EXCESS STOCK RETURN in this bulletin.*

**AFFECTED VEHICLES**

Vehicle	Model Year	Assembly Plant	Build Dates
Transit	2015-2017	Kansas City	January 17, 2014 through June 15, 2017

Affected vehicles are identified in OASIS and FSA VIN Lists.

**REASON FOR THIS SAFETY RECALL**

In the affected vehicles, the driveshaft flexible coupling may crack with increasing mileage, resulting in driveline noise and vibration. Continued driving with a cracked flexible coupling may cause separation of the driveshaft, resulting in a loss of motive power while driving, or unintended vehicle movement in park without the parking brake applied. In addition, separation of the driveshaft can result in secondary damage to surrounding components, including brake and fuel lines. A driveshaft separation may increase the risk of injury or crash.

**SERVICE ACTION**

**For New In-Stock Units**

Before demonstrating or delivering any new in-stock vehicles involved in this recall, dealers are to perform the appropriate Permanent Repair Service Procedures based on the vehicle's configuration following the updated Technical Information.

- Part order requests for permanent repairs are now being accepted for in-stock units only. Dealers are to submit VINs based on order of dealer priority using the SSSC Web Contact Site. This will enable Ford to begin shipping parts by dealer assigned priority as soon as they become available.
- Dealers should print the SSSC Web Contact Site response for each vehicle, which will include the specific list of parts required for the repair.

## For Sold Delivered Units

- For affected vehicles with more than 30,000 miles, or affected vehicles that have not had a driveshaft or driveshaft flexible coupling replaced within the last 30,000 miles, dealers are to replace the driveshaft flexible coupling every 30,000 miles as needed as an interim repair until a permanent repair is available and completed for this safety recall. Ford does not recommend driving affected vehicles with more than 30,000 miles on the driveshaft flexible coupling, except to the dealer for service.
- For affected sold vehicles with less than 30,000 miles, or affected vehicles that have had a driveshaft or driveshaft flexible coupling replaced within the last 30,000 miles, no alteration or interim repair is required until the vehicle or replaced flexible coupling reaches 30,000 miles.

**Note:** The interim repair does not close the recall. The interim repair should not be performed on new in-stock units.

## **OWNER NOTIFICATION MAILING SCHEDULE**

Owner letters were mailed the week of July 17, 2017 advising owners of the safety risk and the interim repair. Dealers should perform the interim repair on affected vehicles with more than 30,000 miles that arrive at their dealerships or that have experienced driveline noise or vibration, whether or not the customer has received a letter.

Owners will be notified again when repair instructions and parts ordering information have been supplied to dealers to provide a permanent repair for this safety recall.

## **PLEASE NOTE:**

**Federal law requires dealers to complete this recall service before a new vehicle is delivered to the buyer or lessee. Violation of this requirement by a dealer could result in a civil penalty of up to \$21,000 per vehicle. Correct all vehicles in your new vehicle inventory before delivery.**

## **New! ATTACHMENTS**

Attachment I: Administrative Information  
*Attachment II: Labor Allowances and Parts Ordering Information*  
Attachment III: Technical Information  
Owner Notification Letter  
Recall Reimbursement Plan

## **QUESTIONS & ASSISTANCE**

For questions and assistance, contact the SSSC via the SSSC Web Contact Site. The SSSC Web Contact Site can be accessed through the Professional Technician Society (PTS) website using the SSSC link listed at the bottom of the OASIS VIN report screen or listed under the SSSC tab.

Sincerely,



Michael A. Berardi

**NEW VEHICLE DEMONSTRATION / DELIVERY HOLD - Safety Recall 17S15 – Supplement #3**  
Certain 2015-2017 Transit Vehicles Equipped with a Driveshaft Flexible Coupling  
Driveshaft Flexible Coupling Repair

**OASIS ACTIVATION**

OASIS will be activated on June 27, 2017.

**FSA VIN LISTS ACTIVATION**

FSA VIN Lists will be available through <https://web.fsavinlists.dealerconnection.com> on June 27, 2017. Owner names and addresses will be available by July 28, 2017.

**NOTE:** Your FSA VIN Lists may contain owner names and addresses obtained from motor vehicle registration records. The use of such motor vehicle registration data for any purpose other than in connection with this recall is a violation of law in several states, provinces, and countries. Accordingly, you must limit the use of this listing to the follow-up necessary to complete this recall.

**SOLD VEHICLES**

- Owners of affected vehicles will be directed to dealers for interim repairs, as required.
- Immediately contact any of your affected customers whose vehicles are not on your VIN list but are identified in OASIS. Give the customer a copy of the Owner Notification Letter (when available) and schedule a service date.
- Correct other affected vehicles identified in OASIS which are brought to your dealership.

**STOCK VEHICLES**

- Correct all affected units in your new vehicle inventory with the Permanent Repair Service Procedures before delivery.
- Part order requests for permanent repairs are now being accepted for in-stock units only. Dealers are to submit VINs based on order of dealer priority using the SSSC Web Contact Site. This will enable Ford to begin shipping parts by dealer assigned priority as soon as they become available.
- Use OASIS to identify any affected vehicles in your used vehicle inventory. Affected vehicles with more than 30,000 miles on the odometer may require the interim repair.

**DEALER-OPERATED RENTAL VEHICLES**

The Fixing America's Surface Transportation (FAST) Act law effective June 2016 prohibits a rental company from selling, renting or leasing vehicles subject to a safety or compliance recall. Please consult your legal counsel for legal advice.

**TITLE BRANDED / SALVAGED VEHICLES**

Affected title branded and salvaged vehicles are eligible for this recall.

**ADDITIONAL REPAIR (LABOR TIME AND/OR PARTS)**

Additional repairs identified as necessary to complete the FSA should be managed as follows:

- For vehicles within new vehicle bumper-to-bumper warranty coverage, follow existing warranty and policy guidelines for related damage claims. No SSSC approval is required for these vehicles:
  - Ford vehicles – 3 years or 36,000 miles
- For vehicles outside new vehicle bumper-to-bumper warranty coverage, submit an Approval Request to the SSSC Web Contact Site prior to completing the repair.

**NEW VEHICLE DEMONSTRATION / DELIVERY HOLD - Safety Recall 17S15 – Supplement #3**

Certain 2015-2017 Transit Vehicles Equipped with a Driveshaft Flexible Coupling  
Driveshaft Flexible Coupling Repair

**OWNER REFUNDS**

- **Claiming a refund will not close the recall on the vehicle.**
- Ford Motor Company is offering a refund for owner-paid repairs covered by this recall if the repair was performed prior to the date indicated in the reimbursement plan, which is posted with this bulletin. Owners are directed to seek reimbursement through authorized dealers or, at their option, directly through Ford Motor Company at P.O. Box 6251, Dearborn, MI 48121-6251.
- Dealers are also pre-approved to refund owner-paid emergency repairs that were performed away from an authorized servicing dealer after the end date specified in the reimbursement plan. Non-covered repairs, or those judged by Ford to be excessive, will not be reimbursed.
- Refunds will only be provided for the cost associated with driveshaft flexible coupling failure.

**RENTAL VEHICLES**

With proper dealer parts ordering and service appointment scheduling, rental vehicles should not be required. However, if you have a unique owner circumstance which may require a rental vehicle, please contact the SSSC via the SSSC Web Contact Site.

**CLAIMS PREPARATION AND SUBMISSION**

- Enter claims using Direct Warranty Entry (DWE) or One Warranty Solution (OWS).
  - DWE: refer to ACESII manual for claims preparation and submission information.
  - OWS: when entering claims in DMS software, select claim type 31: Field Service Action. The FSA number (17S15) is the sub code.
- **Provision for locally obtained Loctite® 243 (or equivalent) – Interim Repair Only:** Submit on the same line as the repair.
  - Program Code: 17S15                      - Misc. Expense: OTHER
  - Misc. Expense: Claim up to \$5.00
- **Provision for Motorcraft® XG-8 (or XG-8-A) – New In-Stock Permanent Repair Service Procedures that require a Driveshaft Slip Yoke Boot Kit:** Submit on the same repair line.
  - Program Code: 17S15                      - Misc. Expense: OTHER
  - Misc. Expense: Claim up to \$3.00
- Additional labor and/or parts must be claimed as related damage on a separate repair line from the FSA.
- Submit refunds on a separate repair line.
  - Program Code: 17S15                      - Misc. Expense: ADMIN
  - Misc. Expense: REFUND                      - Misc. Expense: 0.2 Hrs.
- Multiple refunds should be submitted on one repair line and the invoice details for each repair should be detailed in the comments section of the claim.

**NEW VEHICLE DEMONSTRATION / DELIVERY HOLD - Safety Recall 17S15 – Supplement #3**  
 Certain 2015-2017 Transit Vehicles Equipped with a Driveshaft Flexible Coupling  
 Driveshaft Flexible Coupling Repair

**LABOR ALLOWANCES**

Description	Labor Operation	Labor Time
Interim Repair for Sold, Delivered Units Only: Replace the driveshaft flexible coupling – includes time to clean and re-use certain fasteners (interim repair will NOT close the recall)	17S15MM	0.7 Hours
Interim Repair for Sold, Delivered Units Only: Replace the driveshaft pilot bushing and driveshaft flexible coupling – includes time to clean and re-use certain fasteners (interim repair will NOT close recall)	17S15NN	0.8 Hours
Permanent Repair for 129/130 wheelbase (WB) with 3.2L diesel engine (new in-stock units only)	17S15B	0.8 Hours
Permanent Repair for 129/130 WB with 3.5L gas engine (new in-stock units only)	17S15C	0.8 Hours
Permanent Repair for 129/130 WB with 3.7L gas engine (new in-stock units only)	17S15D	0.9 Hours
Permanent Repair for 138 WB with dual rear wheels (DRW) (new in-stock units only)	17S15E	0.7 Hours
Permanent Repair for 138 WB with single rear wheels (SRW) (new in-stock units only)	17S15F	0.8 Hours
Permanent Repair for 148 WB 3.2L diesel engine with DRW (new in-stock units only)	17S15G	0.8 Hours
Permanent Repair for 148 WB 3.2L diesel engine with SRW; 148 WB with 3.5L gas engine; 148 WB with 3.7L gas engine (new in-stock units only)	17S15H	1.1 Hours

**NEW VEHICLE DEMONSTRATION / DELIVERY HOLD - Safety Recall 17S15 – Supplement #3**

Certain 2015-2017 Transit Vehicles Equipped with a Driveshaft Flexible Coupling  
Driveshaft Flexible Coupling Repair

**PARTS REQUIREMENTS / ORDERING INFORMATION - FOR INTERIM REPAIRS (Sold, Delivered Units Only)**

Part Number	Description	Order Quantity	Claim Quantity
CK4Z-4782-B	Driveshaft Flexible Coupling	1	1
Obtain Locally	Loctite® 243 General Purpose Medium Strength Threadlocking Adhesive (or equivalent) – see Technical Information for usage	Claim as Misc. Expense: OTHER	

**Additional Parts for Driveshaft Pilot Bushing Replacement (based on inspection only)**

CK4Z-4650-A	Driveshaft Pilot Bushing	1	1
W505264-S439	Safety Strap Bolts (4 bolts per pkg., 2 bolts required)	1	1
N800594-S100	Pinion Flange Bolts (4 bolts per pkg., 4 bolts required)	1	1

Less than 5% of the affected vehicle population is expected to require driveshaft pilot bushing replacement.

The DOR/COR number for this recall is 51085.

Order your parts through normal order processing channels. To guarantee the shortest delivery time, an emergency order for parts must be placed.

**NEW VEHICLE DEMONSTRATION / DELIVERY HOLD - Safety Recall 17S15 – Supplement #3**

Certain 2015-2017 Transit Vehicles Equipped with a Driveshaft Flexible Coupling  
Driveshaft Flexible Coupling Repair

**New! PARTS REQUIREMENTS / ORDERING INFORMATION – FOR NEW IN-STOCK UNITS****SSSC Web Contact Site:**

Submit a VIN-specific Part Order contact via the SSSC Web Contact Site. Ford will send the parts required for the specific VIN as they become available.

**NOTE:** The parts required to repair a specific vehicle may not arrive together and the parts required per vehicle will vary based on vehicle configuration. It is important to print out the SSSC response, as it will show what parts are needed for each individual VIN.

**129/130 WHEELBASE NEW IN-STOCK UNITS**

Vehicle Configuration	Part Number	Description	Order Quantity	Claim Quantity
3.2L diesel engine	CK4Z-4602-A	Front Driveshaft Section	1	1
	CK4Z-4635-A	Bolt and Flange Kit	1	1
	JK4Z-5A669-A	Pinion Nose Damper Kit	1	1
	CK4Z-4421-G	Driveshaft Slip Yoke Boot Kit	1	1
	XG-8 or XG-8-A	Motorcraft® Driveshaft Slip Yoke PTFE Lubricant*	Claim as Misc. Expense: OTHER	
3.5L gas engine	CK4Z-4R602-AX	Complete Driveshaft	1	1
	CK4Z-4635-A	Bolt and Flange Kit	1	1
	JK4Z-5A669-A	Pinion Nose Damper Kit	1	1
	CK4Z-4635-B	Lower Profile Center Bearing Bracket Kit	1	1
3.7L gas engine	CK4Z-4602-B	Front Driveshaft Section	1	1
	CK4Z-4635-A	Bolt and Flange Kit	1	1
	JK4Z-5A669-A	Pinion Nose Damper Kit	1	1
	CK4Z-4635-B	Lower Profile Center Bearing Bracket Kit	1	1
	CK4Z-4421-F	Driveshaft Slip Yoke Boot Kit	1	1
	XG-8 or XG-8-A	Motorcraft® Driveshaft Slip Yoke PTFE Lubricant*	Claim as Misc. Expense: OTHER	

\*Order the Motorcraft® Driveshaft Slip Yoke PTFE Lubricant through normal order processing channels.

**NEW VEHICLE DEMONSTRATION / DELIVERY HOLD - Safety Recall 17S15 – Supplement #3**

Certain 2015-2017 Transit Vehicles Equipped with a Driveshaft Flexible Coupling  
Driveshaft Flexible Coupling Repair

**138 WHEELBASE NEW IN-STOCK UNITS**

Vehicle Configuration	Part Number	Description	Order Quantity	Claim Quantity
3.2L diesel engine & DRW	CK4Z-4R602-AY	Complete Driveshaft	1	1
	CK4Z-4635-A	Bolt and Flange Kit	1	1
3.2L diesel engine & SRW	CK4Z-4602-C	Front Driveshaft Section	1	1
	CK4Z-4635-A	Bolt and Flange Kit	1	1
	CK4Z-4421-F	Driveshaft Slip Yoke Boot Kit	1	1
	XG-8 or XG-8-A	Motorcraft® Driveshaft Slip Yoke PTFE Lubricant*	Claim as Misc. Expense: OTHER	
3.7L gas engine & DRW	CK4Z-4R602-BC	Complete Driveshaft	1	1
	CK4Z-4635-A	Bolt and Flange Kit	1	1
3.7L gas engine & SRW	CK4Z-4602-B	Front Driveshaft Section	1	1
	CK4Z-4635-A	Bolt and Flange Kit	1	1
	CK4Z-4421-F	Driveshaft Slip Yoke Boot Kit	1	1
	XG-8 or XG-8-A	Motorcraft® Driveshaft Slip Yoke PTFE Lubricant*	Claim as Misc. Expense: OTHER	

\*Order the Motorcraft® Driveshaft Slip Yoke PTFE Lubricant through normal order processing channels.



**NEW VEHICLE DEMONSTRATION / DELIVERY HOLD - Safety Recall 17S15 – Supplement #3**

Certain 2015-2017 Transit Vehicles Equipped with a Driveshaft Flexible Coupling  
Driveshaft Flexible Coupling Repair

**New! 148 WHEELBASE NEW IN-STOCK UNITS**

Vehicle Configuration	Part Number	Description	Order Quantity	Claim Quantity
3.2L diesel engine & DRW	CK4Z-4R602-BF	Complete Driveshaft	1	1
	CK4Z-4635-A	Bolt and Flange Kit	1	1
	JK4Z-5A669-A	Pinion Nose Damper Kit	1	1
3.2L diesel engine & SRW	CK4Z-4602-E	Front Driveshaft Section	1	1
	CK4Z-4635-A	Bolt and Flange Kit	1	1
	JK4Z-5A669-A	Pinion Nose Damper Kit	1	1
	7L1Z-4635-A	Universal Joint Kit	1	1
3.5L gas engine	CK4Z-4602-F	Front Driveshaft Section	1	1
	CK4Z-4635-A	Bolt and Flange Kit	1	1
	JK4Z-5A669-A	Pinion Nose Damper Kit	1	1
	3G3Z-4635-A	Universal Joint Kit	1	1
3.7L gas engine & DRW	CK4Z-4602-F	Front Driveshaft Section	1	1
	CK4Z-4635-A	Bolt and Flange Kit	1	1
	JK4Z-5A669-A	Pinion Nose Damper Kit	1	1
	3G3Z-4635-A	Universal Joint Kit	1	1
3.7L gas engine & SRW	CK4Z-4602-D	Front Driveshaft Section	1	1
	CK4Z-4635-A	Bolt and Flange Kit	1	1
	JK4Z-5A669-A	Pinion Nose Damper Kit	1	1
	7L1Z-4635-A	Universal Joint Kit	1	1
	JK4Z-4A209-A	Center Bearing 5mm Shim (required on some vehicles only)*	1	1

\*Only vehicles originally equipped with a CK41-4K357-**EAA** Engineering Part driveshaft (as shown in HVBOM) will require a JK4Z-4A209-A shim. Vehicles equipped with a CK41-4K357-**TA\*** or **VA\*** driveshaft (as shown in HVBOM) will not require a shim.

The DOR/COR number for this recall is 51085.

**DEALER PRICE**

For latest prices, refer to DOES II.

**PARTS RETENTION AND RETURN**

Follow the provisions of the Warranty and Policy Manual, Section 1 - WARRANTY PARTS RETENTION AND RETURN POLICIES.

**EXCESS STOCK RETURN**

Excess stock returned for credit must have been purchased from Ford Customer Service Division in accordance with Policy Procedure Bulletin 4000.

**NEW VEHICLE DEMONSTRATION / DELIVERY HOLD - Safety Recall 17S15 – Supplement #3**

Certain 2015-2017 Transit Vehicles Equipped with a Driveshaft Flexible Coupling  
Driveshaft Flexible Coupling Repair

**INDIVIDUAL KIT CONTENTS**

<b>Part Number</b>	<b>Bolt and Flange Kit (CK4Z-4635-A)</b>	<b>Kit Quantity</b>
FL3Z-7089-A	Transmission Output Flange (4-bolt)	1
6L2Z-7045-AA	Transmission Output Flange Castle Nut	1
W713078-S439	Center Bearing Support Bolts	4
N800594-S100	Driveshaft-to-Output Flange & Pinion Flange Bolts	8
W505264-S439	Front Safety Strap Bolts	2

<b>Part Number</b>	<b>Pinion Nose Damper Kit (JK4Z-5A669-A)</b>	<b>Kit Quantity</b>
CK4Z-4A263-D	Pinion Nose Damper	1
W714735-S439	Damper Attaching Bolts	3

<b>Part Number</b>	<b>Lower Profile Center Bearing Bracket Kit (CK4Z-4635-B)</b>	<b>Kit Quantity</b>
JK4Z-4K007-A	Lower Profile Center Bearing Support Bracket	1
W713649-S441	Center Bearing Clip Nuts	2
W505264-S439	Bracket-to-Body Bolts	4

<b>Part Number</b>	<b>Driveshaft Slip Yoke Boot Kit (CK4Z-4421-F)</b>	<b>Kit Quantity</b>
CK4Z-4421-A	Driveshaft Slip Yoke Dust Boot	1
9L1Z-3B478-A	50mm Clamp	1
F85Z-4K227-AA	41.5mm Clamp	1

<b>Part Number</b>	<b>Driveshaft Slip Yoke Boot Kit (CK4Z-4421-G)</b>	<b>Kit Quantity</b>
CK4Z-4421-A	Driveshaft Slip Yoke Dust Boot	1
9L1Z-3B478-A	50mm Clamp	2

## CERTAIN 2015-2017 TRANSIT VEHICLES EQUIPPED WITH A DRIVESHAFT FLEXIBLE COUPLING — DRIVESHAFT FLEXIBLE COUPLING REPAIR

### OVERVIEW

In the affected vehicles, the driveshaft flexible coupling may crack with increasing mileage, resulting in driveline noise and vibration. Continued driving with a cracked flexible coupling may cause separation of the driveshaft, resulting in a loss of motive power while driving, or unintended vehicle movement in park without the parking brake applied. In addition, separation of the driveshaft can result in secondary damage to surrounding components, including brake and fuel lines. A driveshaft separation may increase the risk of injury or crash. For affected vehicles with more than 30,000 miles, or affected vehicles that have not had a driveshaft or driveshaft flexible coupling replaced within the last 30,000 miles, dealers are to replace the driveshaft flexible coupling every 30,000 miles as needed as an interim repair until a permanent repair is available and completed for this safety recall. Ford does not recommend driving affected vehicles with more than 30,000 miles on the driveshaft flexible coupling, except to the dealer for service. For in-stock units, dealers are to perform the appropriate Permanent Repair Service Procedures based on the vehicle's configuration.

### SERVICE PROCEDURES

**INTERIM REPAIR - FLEXIBLE COUPLING REPLACEMENT..... Page 2**

**PERMANENT REPAIR FOR IN-STOCK UNITS..... Page 7**

#### Recommended Tool List:

3/8" Drive Impact Gun
3/8" Drive 10mm, 13mm, and 15mm Shallow Sockets
3/8" Drive 12mm, 12-Point Shallow Socket
3/8" Drive Extension 12 in (305 mm)
1/2" Drive Impact Gun
1/2" Drive 18mm and 21mm Shallow Sockets
3/8" and 1/2" Drive Torque Wrench
1/2" Impact Swivel
21mm Wrench
Hammer
Screwdriver - Flat Head
Punch/Chisel
Mini-Ductor™ induction heating tool, or equivalent
Ruler - Driveshaft Pilot Bushing And Driveshaft Flexible Coupling Replacement
3-Jaw Puller - Driveshaft Pilot Bushing And Driveshaft Flexible Coupling Replacement
1/2 Drive 34mm 12-Point Deep Socket - Transmission Output Shaft Flange Replacement
Oetiker® Clamp Pliers - Driveshaft Front Section Replacement On a 2-Piece Equipped Driveshaft
Side Cutters - Driveshaft Front Section Replacement On a 2-Piece Equipped Driveshaft
C-Frame and Screw - Driveshaft Front Section Replacement On a 3-Piece Equipped Driveshaft
Snap Ring Pliers - Driveshaft Front Section Replacement On a 3-Piece Equipped Driveshaft
Rubber Hammer - Driveshaft Front Section Replacement On a 3-Piece Equipped Driveshaft



### INTERIM REPAIR - FLEXIBLE COUPLING REPLACEMENT

1. With the vehicle in NEUTRAL, position it on a hoist. Please follow the Workshop Manual (WSM) procedures in Section 100-02.
2. Inspect the driveshaft flexible coupling. Is the flexible coupling severely cracked with nylon cords showing? See Figure 1.

No - Proceed to Page 3 for Driveshaft Flexible Coupling Replacement.

Yes - Proceed to Page 4 for Driveshaft Pilot Bushing and Driveshaft Flexible Coupling Replacement.



FIGURE 1



### Driveshaft Flexible Coupling Replacement - In-Vehicle Procedure

1. **NOTE:** All fasteners shown in the WSM can be reused for this interim repair following the procedures below. The safety strap bolts and driveshaft to pinion flange bolts are not removed.

**NOTE:** The use of an assistant is not required for this repair as it is not necessary to completely remove the driveshaft. A stand may be used to support the driveshaft.

Replace the Driveshaft Flexible Coupling. Please follow the WSM procedures in Section 205-01.

- To assist with the removal of the driveshaft flexible coupling-to-transmission output flange bolts, the use of a Mini-Ductor™ induction heating tool, or equivalent, is recommended.
- The blue paint marking on the *new* driveshaft flexible coupling must be installed facing the transmission output flange or premature failure of the flexible coupling will occur. See Figure 2a.
- Clean and re-use the six driveshaft flexible coupling bolts. Starting at the end of the bolt, leave one or two threads free of adhesive and apply Loctite 243® threadlocking adhesive (or equivalent) to at least seven threads minimum. See Figure 2b.
- The driveshaft center bearing attaching bolts can be reused without the use of Loctite®.

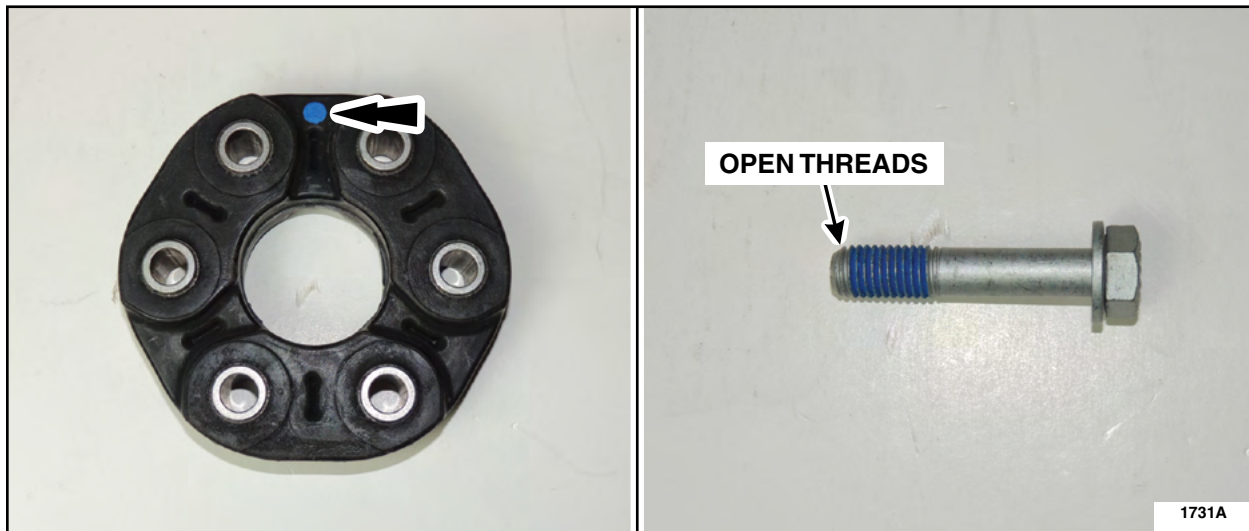

FIGURE 2a

FIGURE 2b



### Driveshaft Pilot Bushing And Driveshaft Flexible Coupling Replacement

1. **NOTE:** All fasteners will be reused upon installation except the driveshaft safety strap and the driveshaft to pinion flange bolts.

Remove the driveshaft and the driveshaft flexible coupling following the driveshaft removal and installation procedure in WSM Section 205-01.

- To assist with the removal of the driveshaft flexible coupling-to-transmission output flange bolts, the use of a Mini-Ductor™ induction heating tool, or equivalent, is recommended.

2. Using a hammer and chisel with a sharp edge, remove and discard the driveshaft pilot bushing. See Figure 3.

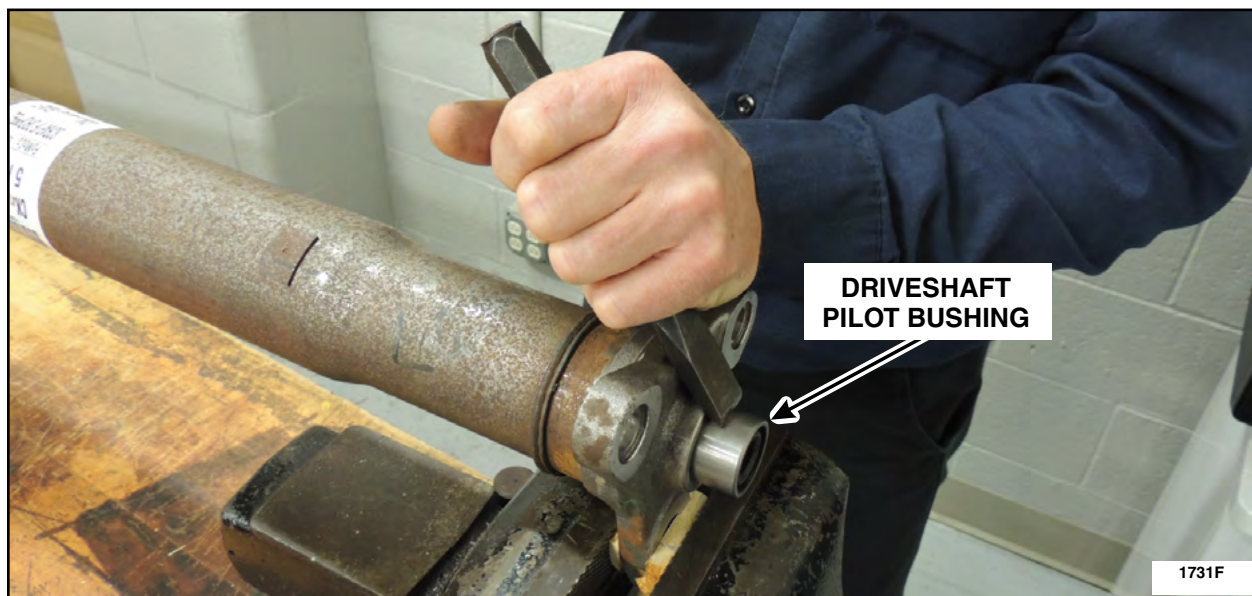
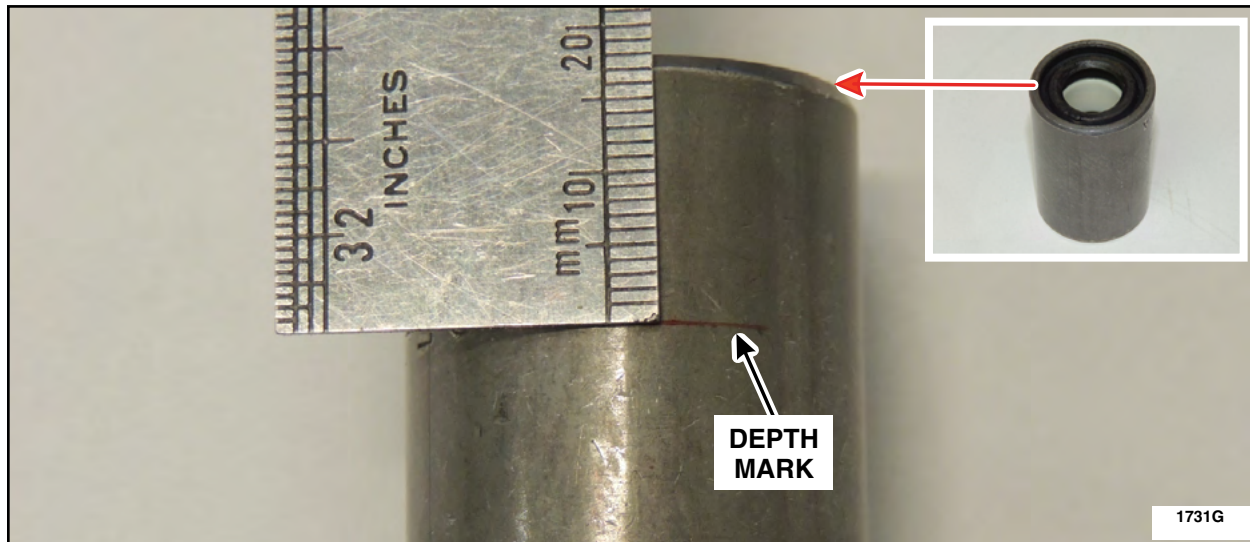

**FIGURE 3**





3. Measure 18 mm (11/16 in) from the seal end of the new pilot bushing and mark the depth.  
See Figure 4.



**FIGURE 4**

4. **NOTE:** Prior to installation of the new driveshaft pilot bushing, make sure the rubber seal end of the bushing is facing outward and the capped end is pressed into the driveshaft.

Using a 3-jaw puller and a suitable flat piece of metal, press in the new pilot bushing until the previously measured depth has been reached. See Figure 5.



**FIGURE 5**



5. Install a new driveshaft flexible coupling and reinstall the driveshaft following the driveshaft removal and installation procedure in WSM Section 205-01.

- The blue paint marking on the new driveshaft flexible coupling must be installed facing the transmission output flange or premature failure of the flexible coupling will occur. See Figure 6a.
- Clean and re-use the six driveshaft flexible coupling bolts. Starting at the end of the bolt, leave one or two threads free of adhesive and apply Loctite 243® threadlocking adhesive (or equivalent) to at least seven threads minimum. See Figure 6b.
- The driveshaft center bearing attaching bolts can be reused without the use of Loctite®.

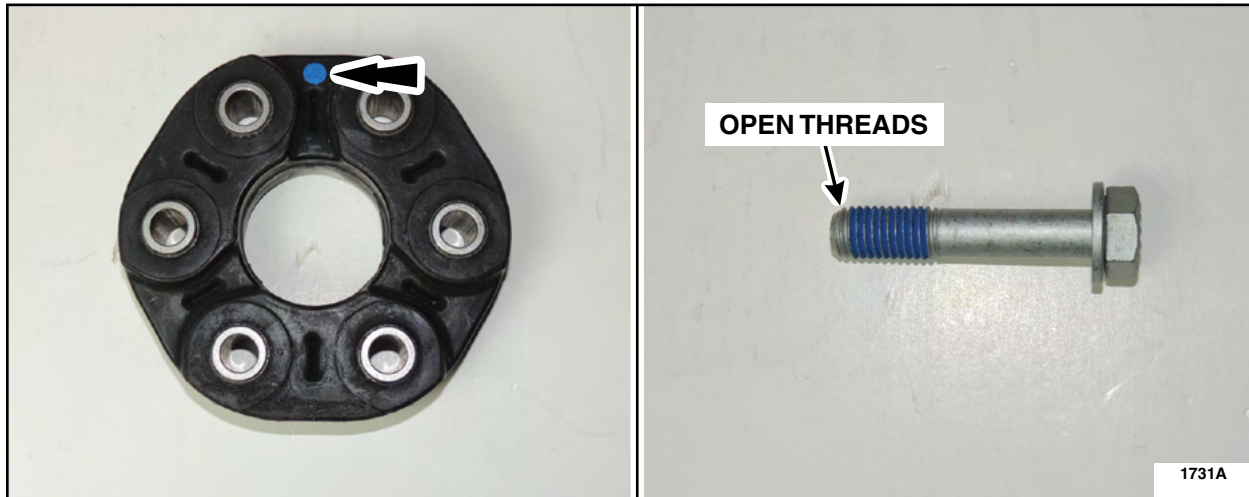

FIGURE 6a

FIGURE 6b





## PERMANENT REPAIR FOR IN-STOCK UNITS

Match the vehicle's configuration to the list of wheelbase configurations below to determine the appropriate Permanent Repair Service Procedures.

**NOTE:** Vehicle wheelbase can be found:

- On the vehicle window sticker, which can be viewed from the OASIS pull down menu on PTS, or the window sticker link in HVBOM
- On the Vehicle Certification Label
- By clicking the Additional Information link on OASIS, and scrolling through the Build Information

### 129/130 WHEELBASE VEHICLES

- 3.2L diesel engine.....Permanent Repair Service Procedures A, D, & F
- 3.5L gas engine.....Permanent Repair Service Procedures A, B, C, & F
- 3.7L gas engine.....Permanent Repair Service Procedures A, B, D, & F

### 138 WHEELBASE VEHICLES

- With Dual Rear Wheels (DRW).....Permanent Repair Service Procedures A, & C
- With Single Rear Wheels (SRW).....Permanent Repair Service Procedures A, & D

### 148 WHEELBASE VEHICLES

- 3.2L diesel engine and DRW..... Permanent Repair Service Procedures A, C & F
- All Other Configurations.....Permanent Repair Service Procedures A, E, & F

## PERMANENT REPAIR SERVICE PROCEDURES

- A. Transmission Output Shaft Flange Replacement..... Page 8
- B. Lower Profile Center Bearing Bracket Removal and Installation.....Page 10
- C. Complete Driveshaft Replacement..... Page 11
- D. Driveshaft Front Section Replacement On a 2-Piece Equipped Driveshaft..... Page 12
- E. Driveshaft Front Section Replacement On a 3-Piece Equipped Driveshaft..... Page 13
- F. Pinion Nose Damper Replacement or Installation..... Page 14



### A. Transmission Output Shaft Flange Replacement

1. Remove the Driveshaft. Please follow the WSM procedures in Section 205-01.
2. Using a 1/2" drive, 34mm, 12-point deep socket, remove and discard the 3-bolt transmission output shaft flange retaining nut and flange. (See Figure 7):

**NOTICE: The output shaft flange retaining nut has been staked to prevent it from coming loose. Prior to removing the nut, remove the stake to prevent damage to the output shaft.**

- a. Remove the output shaft flange retaining nut stakes.
- b. Place the vehicle in the PARK position and remove and discard the output shaft flange retaining nut.
- c. Remove and discard the 3-bolt transmission output shaft flange.

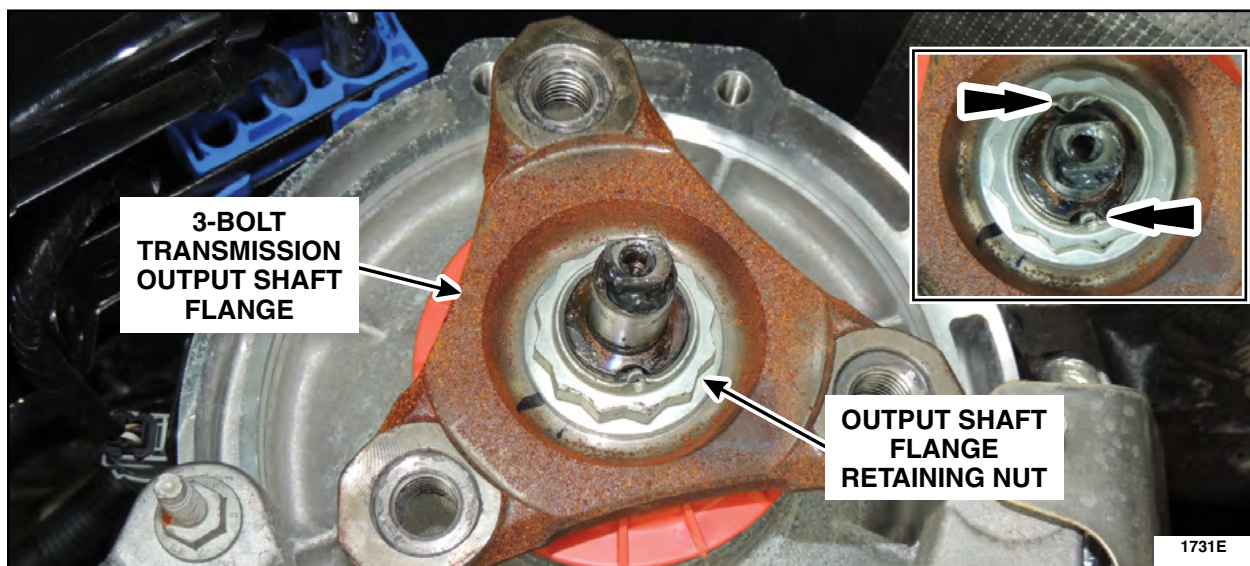

FIGURE 7



3. Using a 1/2" drive, 34mm, 12-point deep socket, install a *new* 4-bolt transmission output shaft flange and retaining nut. (See Figures 8 and 9):

**NOTICE:** The output shaft flange retaining must be staked to prevent it from coming loose.

- a. Install a *new* 4-bolt transmission output shaft flange.
- b. Install a *new* output shaft flange retaining nut.
  - Tighten nut to 59 lb.ft (80 Nm).
- c. Stake the output shaft flange retaining nut.

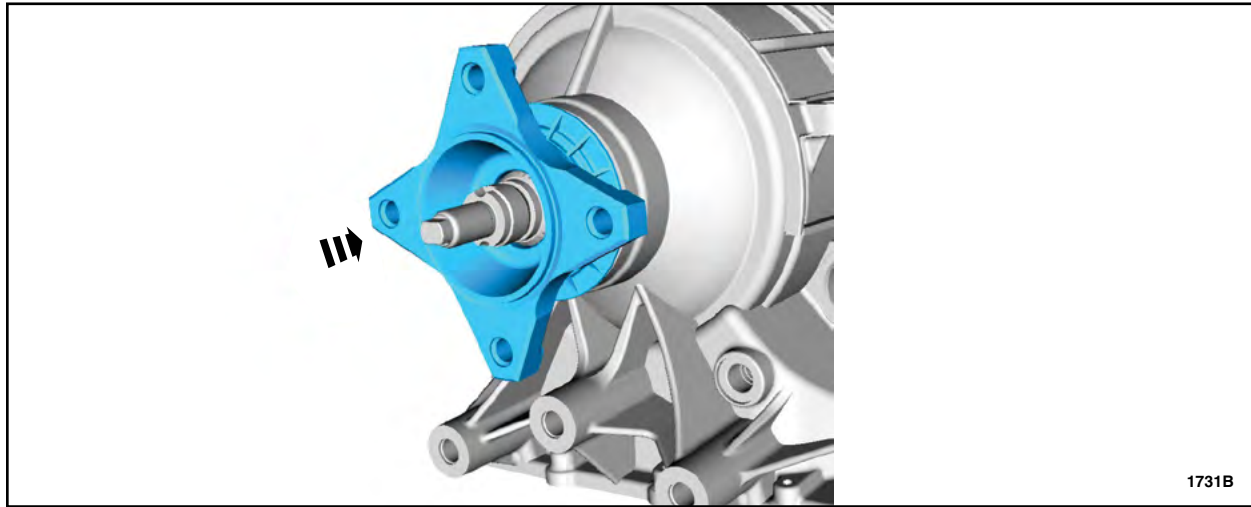

FIGURE 8

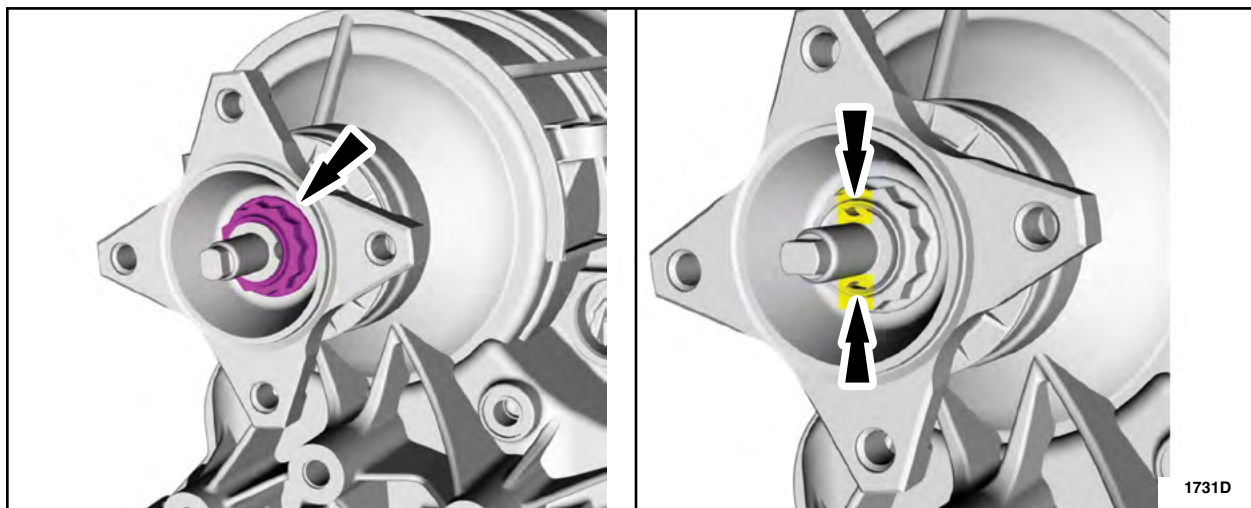

FIGURE 9

4. Proceed to the next required Permanent Repair Service Procedure.



## B. Lower Profile Center Bearing Bracket Removal and Installation

**NOTE:** Lower profile center bearing bracket kit includes a *new* bracket, four retaining bolts, and the two spring nuts for the procedure below.

1. Remove and discard the four center bearing bracket retaining bolts and the center bearing bracket. See Figure 10.

**NOTE:** Original center bearing bracket shown, *new* bracket is similar.

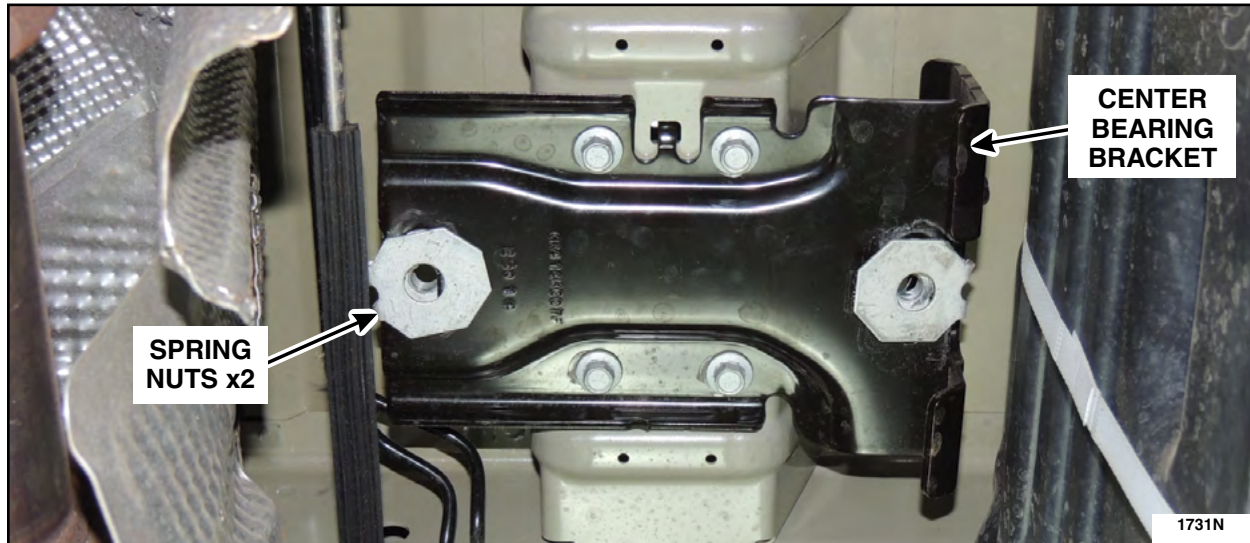

**FIGURE 10**

2. Install the center bearing bracket spring nuts onto the *new* center bearing bracket.
3. Install the *new* center bearing bracket using four *new* retaining bolts. See Figure 10.
  - Tighten bolts to 18 lb.ft (25 Nm).
4. Proceed to the next required Permanent Repair Service Procedure.



**C. Complete Driveshaft Replacement**

1. Install a *new* Driveshaft. Please follow the WSM procedures in Section 205-01.
2. Proceed to the next required Permanent Repair Service Procedure.





#### D. Driveshaft Front Section Replacement On a 2-Piece Equipped Driveshaft

1. Separate the driveshaft front and rear sections at the driveshaft slip yoke. See Figure 11.
  - a. Cut and discard both dust boot Oetiker® clamps.
  - b. Separate the driveshaft front and rear sections.
  - c. Remove and discard the dust boot.

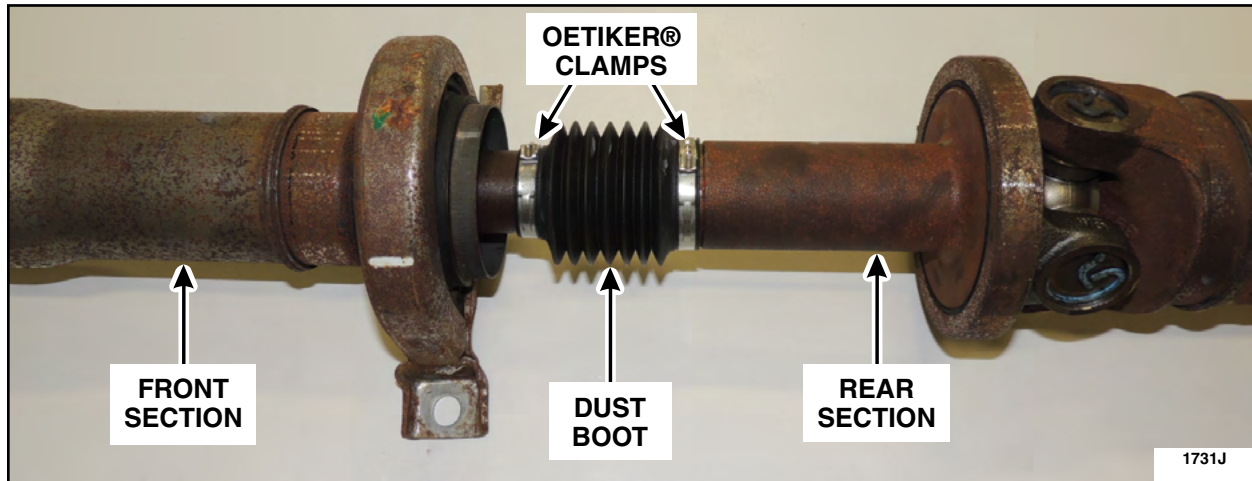

**FIGURE 11**

2. Install a *new* driveshaft front section onto the rear section. See Figures 11 and 12.
  - a. Slide a *new* slip yoke dust boot over the driveshaft rear section.
  - b. Lubricate the front section splines using 10-20 grams (0.35 - 0.7 oz) of Motorcraft® XG-8 Driveshaft Slip Yoke PTFE Lubricant.
  - c. Attach the driveshaft front and rear sections. Make sure the front and rear driveshaft spline keys are aligned when mating the two sections together.
  - d. Make sure the slip yoke dust boot is properly aligned over each driveshaft section and tighten the dust boot Oetiker® clamps.

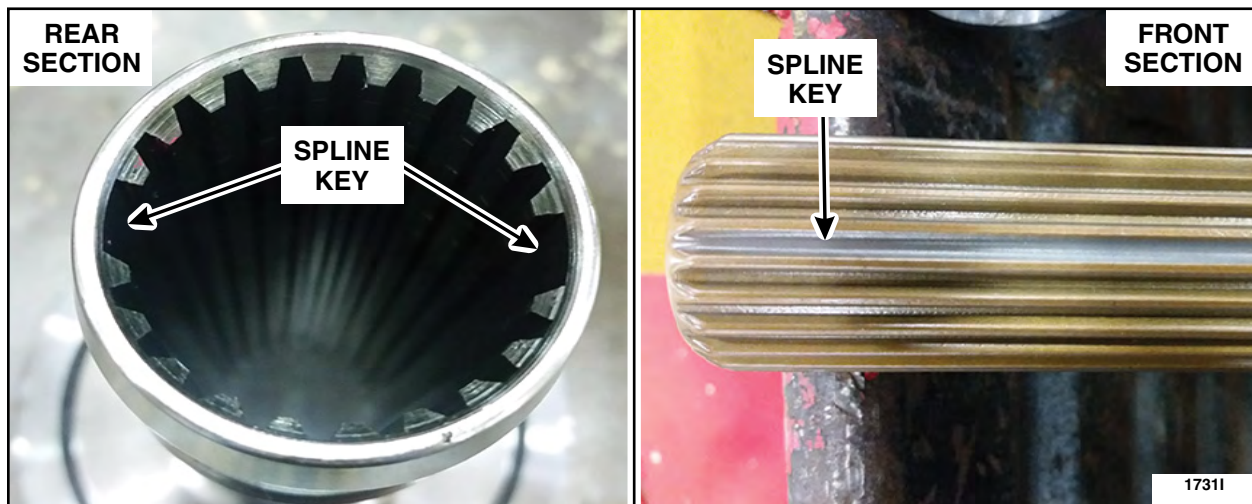

**FIGURE 12**

3. Install the driveshaft assembly. Please follow the WSM procedures in Section 205-01.
4. Proceed to the next required Permanent Repair Service Procedure.



### E. Driveshaft Front Section Replacement On a 3-Piece Equipped Driveshaft

1. Remove and discard the four snap rings and center u-joint to separate the front driveshaft section from the center section. Please follow the Universal Joint Kit Installation Instructions. See Figure 13.

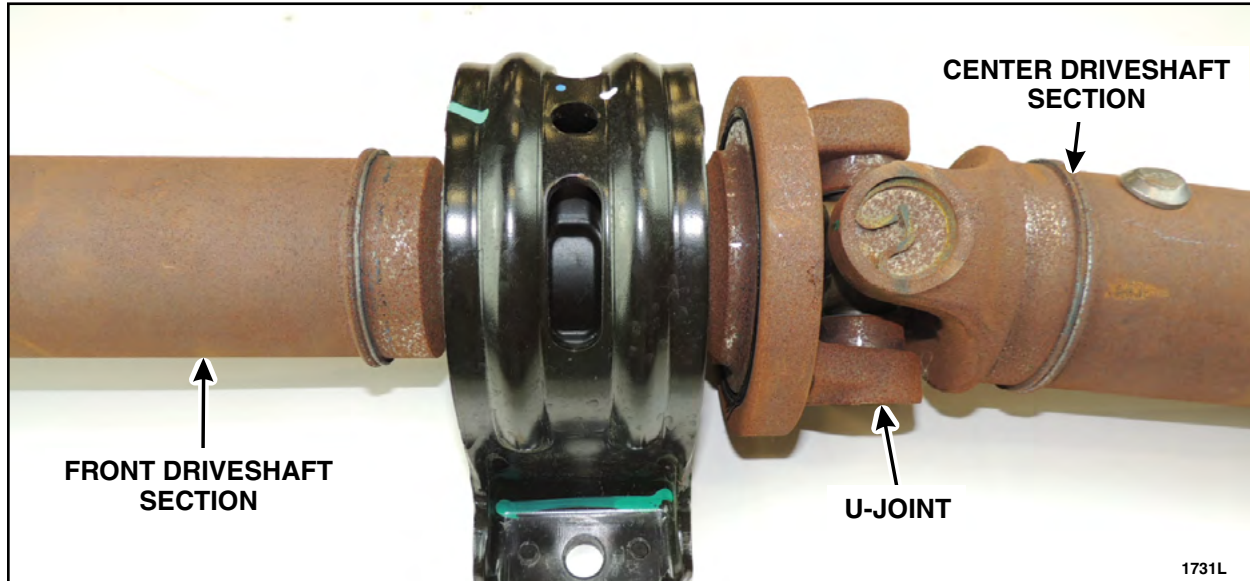

**FIGURE 13**

2. Install a *new* center u-joint and snap rings to attach the front driveshaft section to the center section. Please follow the Universal Joint Kit Installation Instructions.
3. Is the vehicle equipped with a 3.7L gas engine with single rear wheels, and does the Special Service Support Center (SSSC) VIN-specific part order contact response indicate a 4A209 base part number front center bearing shim is required for the vehicle?

**NOTE:** If the SSSC part order contact response is not available, refer to the Parts Ordering Information in Attachment II for the 148 wheelbase units for more detail.

No - Install the driveshaft assembly. Please follow the WSM procedures in Section 205-01.  
Proceed to the next required Permanent Repair Service Procedure.  
Yes - Proceed to Step 4.

4. Install the driveshaft and the 5mm center bearing shim between the front driveshaft center bearing and the center bearing support bracket. Please follow the WSM procedures in Section 205-01.
5. Proceed to the next required Permanent Repair Service Procedure.



## F. Pinion Nose Damper Replacement or Installation

1. If a pinion nose damper is present, remove and discard the three bolts and the original pinion nose damper located on the RH side of the rear axle center housing. See Figure 14.
2. Install a *new* pinion nose damper and tighten the three bolts. See Figure 14.
  - Tighten bolts to 46 lb.ft (62 Nm).

**NOTE:** Original pinion nose damper is shown. *New* pinion nose damper may appear similar to the original (if equipped), but the dampening characteristics have been changed.

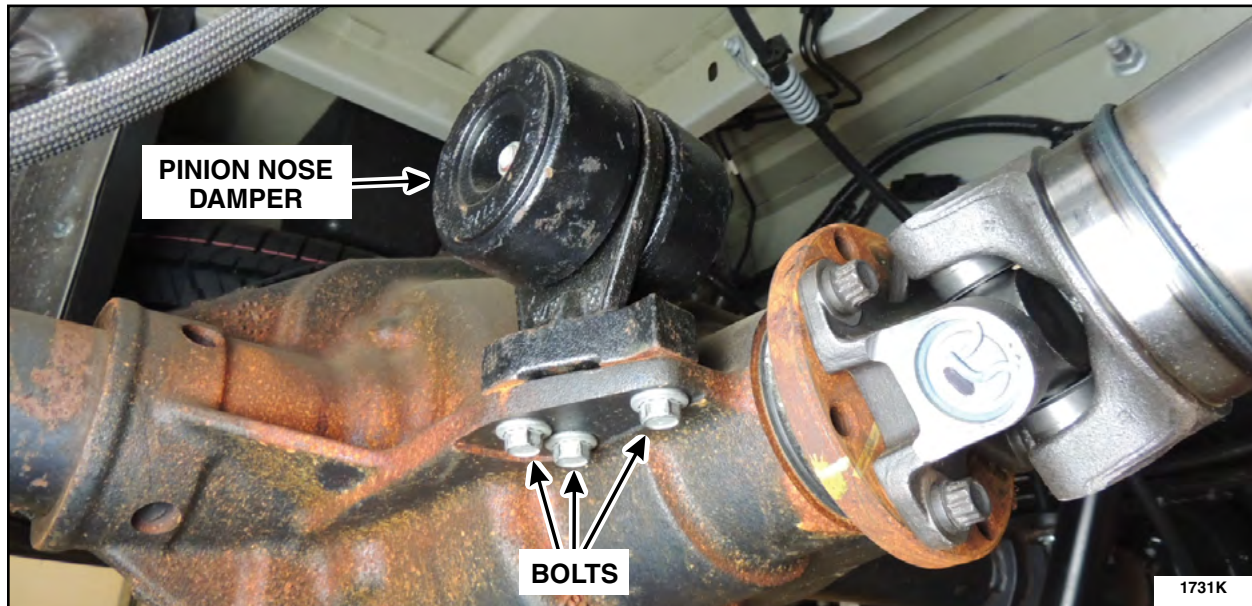

FIGURE 14

