

Product Safety Recall

15818 Front Passenger Air Bag Inflator



Release Date: November 2018

Revision: 00

Attention: General Motors has agreed to help facilitate the repair of the 2005 model year Saab 9-2X vehicles involved in this safety recall. All GM dealers are authorized to perform the required repair and submit for compensation through the Global Warranty Management (GWM) system. The parts needed to complete the repair are available directly from GMCCA via the normal parts ordering process. All involved vehicles are identified by Vehicle Identification Number (VIN) on the Investigate Vehicle History (IVH) screen in the GWM system.

This safety recall is included in the Takata Air Bag Completion Rate Improvement Program. This program is applicable to U.S. dealers only and includes a \$50.00 dealer completion bonus along with authorization for dealers to provide involved vehicle owners with courtesy transportation while their vehicle is being repaired. Refer to GM Service Information Bulletin #18-NA-094 for program guidelines.

It is a violation of Federal law for a dealer to deliver a new motor vehicle or any new or used item of motor vehicle equipment (including a tire) covered by this notification under a sale or lease until the defect or noncompliance is remedied.

All involved vehicles that are in dealer inventory must be held and not delivered to customers, dealer traded, or used for demonstration purposes until the repair contained in this bulletin has been performed on the vehicle.

Make	Model	Model Year		RPO	Description
		From	To		
Saab	9-2X	2005	2005		

Involved vehicles are marked "open" on the Investigate Vehicle History screen in GM Global Warranty Management system. This site should always be checked to confirm vehicle involvement prior to beginning any required inspections and/or repairs.

Condition	It has been determined that a defect, which relates to motor vehicle safety, exists in all 2006 model year Saab 9-2X vehicles that are not currently registered and, have never been registered, in Alabama, California, Florida, Georgia, Hawaii, Louisiana, Mississippi, South Carolina, Texas, Guam, Puerto Rico, Saipan, U.S. Samoa or U.S. Virgin Islands. In these vehicles, the front passenger air bag inflator module may experience an alteration over time, which could lead to overaggressive combustion in the event of an air bag deployment. This condition could create excessive internal pressure when the air bag is deployed, which could result in the body of the inflator rupturing upon deployment. In the event of an inflator rupture, metal fragments could pass through the air bag cushion material, which may result in injury or death to vehicle occupants.
Correction	Dealers are to replace the front passenger air bag inflator.

Dealer Completion Bonus - U.S. Dealers Only

As part of the Takata Air Bag Completion Rate Improvement Program, dealers will be paid a \$50.00 bonus for the completion of the service procedure described in this bulletin. Refer to GM Service Information Bulletin #18-NA-094 for program guidelines.

Parts

Quantity	Part Name	Part No.
1	Front Passenger Air Bag Inflator	84651228

Parts required to complete this recall are to be obtained from General Motors Customer Care and Aftersales (GMCCA). **Order parts on a CSO only. All orders will be reviewed prior to being filled and DRO's may be cancelled. Parts may also have quantity limiters in effect.**

IMPORTANT: Due to limited initial parts availability, dealers are encouraged not to order parts for use as shelf stock.

If stock is not located at your Administrative PDC, due to flight restrictions for hazardous goods shipments, dealer orders may arrive via FedEx or with your normal PDC delivery. **Do not place orders as an OVN or SPAC case; as it will delay shipment of the part and will not provide visibility for order tracking.** Parts will not be shipped overnight, so plan accordingly for transit time to reach your facility.

IMPORTANT: All front passenger air bag inflators replaced in accordance with this recall must be returned to TK Holdings, Incorporated. Under no circumstances should any replaced air bag inflator be returned to GM, ORIO or Subaru of

Product Safety Recall

15818 Front Passenger Air Bag Inflator



America. Refer to the return shipping instructions provided at the end of this bulletin. **Do not discard or destroy the box containing the new air bag inflator, it will be needed to return the old air bag inflator.**

Courtesy Transportation - U.S. Dealers Only

As part of the Takata Air Bag Completion Rate Improvement Program, dealers are authorized to provide alternate transportation to affected vehicle owners while their vehicle is at a GM dealership for completion of the service procedure described in this bulletin. Refer to GM Service Information Bulletin #18-NA-094 for program guidelines.

Warranty Information

Labor Operation	Description	Labor Time	Trans. Type	Net Item
9104204	Replace Front Passenger Air Bag Inflator	1.1	ZFAT	* ** ***

- * Submit a \$20.00 administrative allowance for return of the old front passenger air bag inflator (includes document preparation and packaging). Add this amount in the Administrative Allowance Net Item Field when submitting the repair transaction.
- ** **U.S. Dealers Only:** As part of the Takata Air Bag Completion Rate Improvement Program, dealers are eligible for a \$50.00 completion bonus for each repair performed. Add this amount in the Miscellaneous Net Item Field when submitting the repair transaction. Refer to GM Service Information Bulletin #18-NA-094 for program guidelines.
- *** **U.S. Dealers Only:** As part of the Takata Air Bag Completion Rate Improvement Program, involved vehicle owners are eligible for courtesy transportation while their vehicle is being repaired. If courtesy transportation is required, add the actual cost in the Courtesy Transportation Net Item Field when submitting the repair transaction. Refer to GM Service Information Bulletin #18-NA-094 for program guidelines.

Part Return Instructions

All front passenger air bag inflators replaced in accordance with this recall must be returned to TK Holdings, Incorporated. Do not discard or destroy the box containing the new air bag inflator, it will be needed to return the old air bag inflator. The box also contains forms and labels for the return of the old air bag inflator. **Except for the return address label, discard all other documents in the box as they have been superseded and are no longer applicable. Instead, follow the “Continental U.S. Return Procedure” provided at the end of this bulletin.** These instructions were originally intended for Saab Official Service Centers (OSCs), but have been approved for all GM dealers except Canada. **GM dealers located in Canada must follow the “Canada Only - Used Airbag Return Process” provided at the end of this bulletin.**

WARNING: Do not deploy any front passenger air bag inflator prior to shipment. Doing so could result in severe injury to the technician or other people in the area.

NOTE: When affixing return shipping labels to the box do not obstruct the bar code label. A copy of the job card must also be included in the box with the returned air bag inflator. The job card number, repair date, repair mileage and full 17-character VIN must be clearly visible on the job card.

Special Tools

The air bag mounting bracket, shown below, must be used to safely perform the front passenger air bag inflator replacement procedure described in this bulletin. All GM dealers should already have at least one of these mounting brackets in their special tool inventory. They were provided by GM through Bosch Automotive Service Solutions in late 2015 to address previous Takata air bag safety recalls. The Bosch special tool number is EL-51377. If your dealership does not have the air bag mounting bracket, do not attempt to perform this service procedure and immediately contact Bosch at 1-800-GM-TOOLS for assistance. Attempting to replace the front passenger air bag inflator without using the bracket poses a safety risk for the technician and anyone else in the area.

Product Safety Recall

15818 Front Passenger Air Bag Inflator

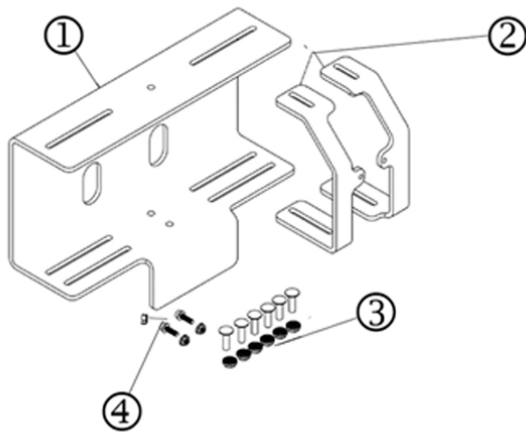

4006668

(1) Mounting Bracket (2) Support Bars (3) Support Bar Hardware (4) Air Bag Mounting Hardware.

Service Procedure

WARNING: It is a safety requirement to use the air bag mounting bracket to perform the front passenger air bag inflator replacement procedure. If the air bag mounting bracket is not available, do not proceed with this repair.

NOTE: This recall bulletin provides service repair and labor time information for replacing the front passenger side air bag inflator only. Other repairs, if required, are to be billed under warranty, goodwill assistance or customer pay.

Preparation for Reading Diagnostic Trouble Codes (DTCs)

1. Air bag System – Diagnostic Trouble Code (DTC) read out. Determine if any pre-recall diagnostic trouble codes (DTCs) exist. Record set DTCs if present, on the job card. Notify the vehicle owner of condition, cause and correction recommendation and secure the owner's authorization to proceed with any non-recall related repairs prior to continuing with the recall procedure.

1.1 Remove the lower steering column trim.

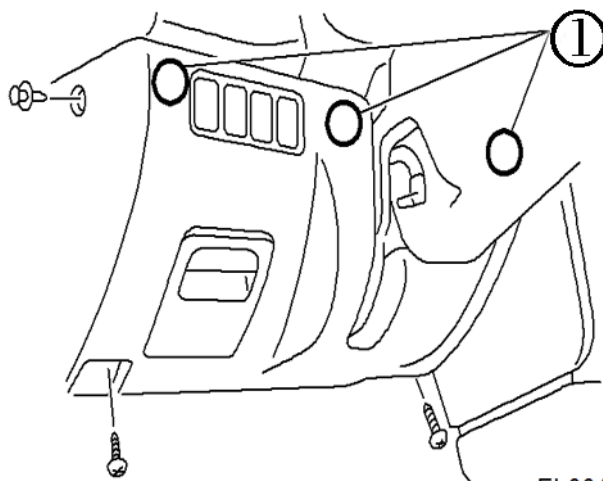

FIGURE 5145811

1.2 Remove 3 philips-head screws, pull the instrument panel lower cover at the clips (1) to remove.

1.3 Locate the B79 Check Connector near the OBDII connector.

1.4 Disconnect the two connectors to the switches on the left side of the panel to provide additional clearance.

Product Safety Recall

15818 Front Passenger Air Bag Inflator



5145813



5145814

- 1.5 Carefully rotate the panel counter-clockwise to remove the B79 Check Connector screw. Leave the OBDII connector attached to the panel.



5145816

- 1.6 Remove the tape covering the Ground Terminals. You are now ready to check flashing codes by viewing the air bag light.

Reading DTCs

1. Turn the ignition switch to the "ON" position.

Product Safety Recall

15818 Front Passenger Air Bag Inflator



1.1 Make sure the headlights are turned off and a battery tender is connected.

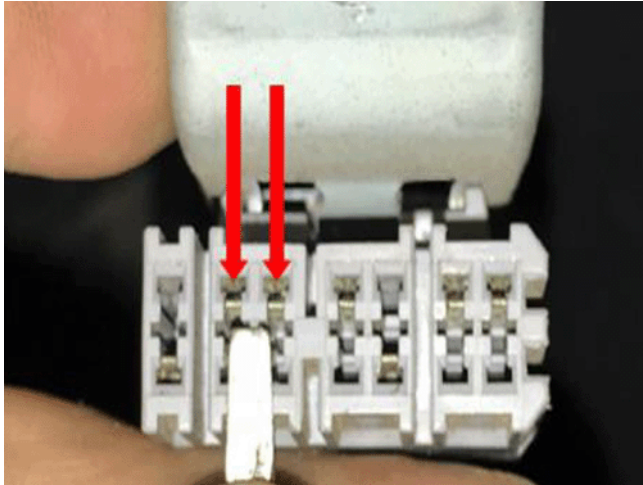

5145817

1.2 Locate B79 Check Connector Pins 2 and 3.

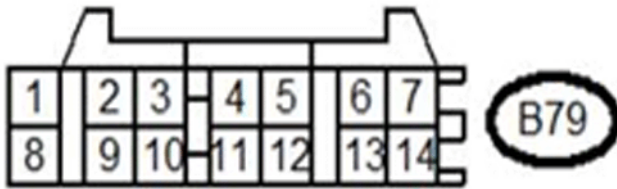

5145820

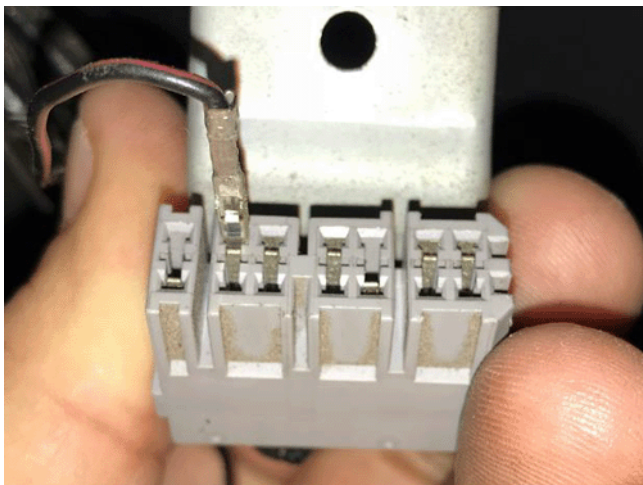

5145822

1.3 Connect either one of the Ground Terminals to B79 Check Connector pin 2.

Product Safety Recall

15818 Front Passenger Air Bag Inflator



5145828

- 1.4 Watch the “AIRBAG” warning light in the cluster. It will begin to blink.
- 1.5 The long segments (1.2 seconds on) indicates a “ten”, and the short segment (0.3 seconds on) indicates a “one”. The warning light flashes a code corresponding to the fault.
- 1.6 There will be a brief pause approximately 6 seconds long between each DTC (No Light).
- 1.7 Read all codes until they begin to repeat. Write down all the codes.
- 1.8 See **DTC Code Listing chart – Table 1** at bottom of document for DTC code descriptions.

IMPORTANT: A series of long flashes over and over (1.2 seconds on) indicates no codes are present.

2. If DTCs are found, correct the condition with the vehicle owner’s signed authorization and then erase the DTCs.

Erasing DTCs

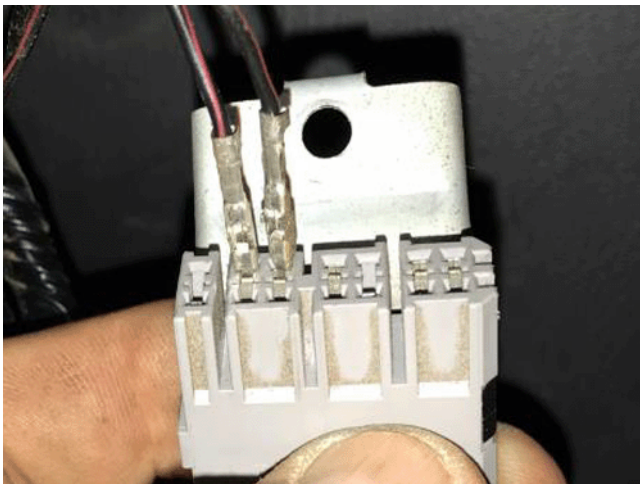

5145830

1. With the first Ground Terminal still connected and while the “AIRBAG” warning light flashes, connect the other Ground Terminal to the B79 Check Connector pin 3.
 - 1.1 Once the fault is repaired and the memory is erased, the warning light will flash one long time (1.2 seconds on) and then returns to the normal flash rate (0.6 sec on).
 - 1.2 If the warning light does not return the normal flash rate (0.6 sec on) this indicates that a fault remains. Once the repair has been made, erase the memory again and confirm that the normal flash rate has returned.
 - 1.3 When the memory has been cleared, disconnect the Ground Terminals from the B79 Check Connector.
 - 1.4 Apply insulating tape around the Ground Terminals and secure them to the harness with tape.
 - 1.5 Reattach the Check Connector to the panel with the Phillips screw.
 - 1.6 Turn the ignition switch off.

Product Safety Recall

15818 Front Passenger Air Bag Inflator



- 1.7 Rotate panel back to correct orientation.
- 1.8 Carefully line up the 3 upper clips that hold the panel on.



5145832

- 1.9 Snap the trim panel back into place.
- 1.10 Reinstall the 3 Phillips screws.
- 1.11 Turn Ignition Switch on.
- 1.12 Verify that the "AIRBAG" warning light comes on for 3 seconds and then goes out.

Safety Precautions

WARNING: If an air bag system is not handled using proper procedures and methods, it may be activated accidentally during work resulting in life-threatening injuries. If the service procedure is NOT performed correctly, the system may fail to activate when needed. Be sure to perform the proper work safely and according to the instructions in this recall bulletin.

- **Eliminate Static Electricity.** Before start of work, touch a metallic portion of the vehicle with a bare hand to discharge static electricity charged on your body.
 - **DO NOT Measure Resistance.** DO NOT measure resistance of air bag components. Measuring current of a circuit tester may cause accidental activation.
 - **Handle The Air Bag Properly.** If an inflator is dropped, replace it with a **NEW** inflator.
 - **DO NOT Allow Foreign Objects Near Air Bag.** Collect and account for all removed nuts-bolts to prevent them from landing in the air bag assembly. Any foreign objects in the air bag assembly may cause damage or injury if the air bag is activated.
 - **Wear Protective Equipment.** Always wear appropriate protective equipment when working on the air bag.
1. Turn off the ignition.
 2. Disconnect the Negative (ground) cable from the battery and wait **at least 90** seconds before proceeding further.

CAUTION: To avoid scratching or damaging the dashboard assembly, place protective tape on the dashboard around the air bag, if needed.

Product Safety Recall

15818 Front Passenger Air Bag Inflator

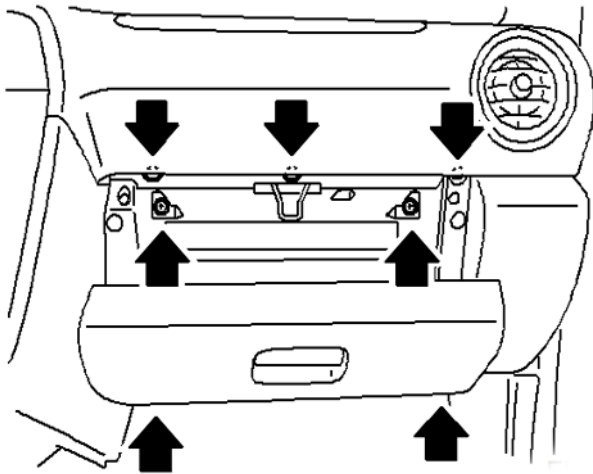

5145835

3. Remove the glove box assembly.
 - 3.1. Open the glove box.
 - 3.2. Remove the glove box screws.
 - 3.3. Remove the glove box.

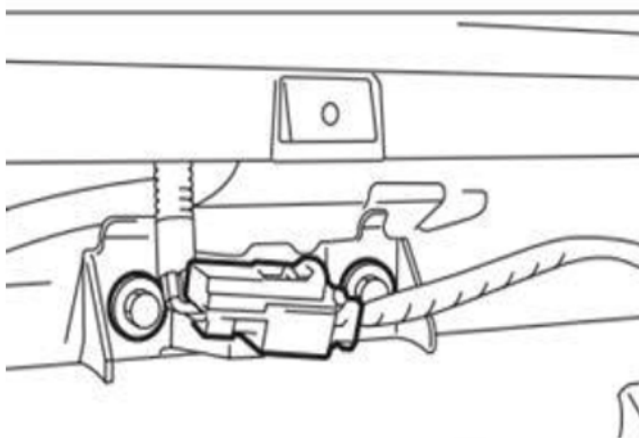

5145837

4. Disconnect the air bag assembly harness connector from the support beam bracket.
5. Remove the 3 retaining bolts and **CAREFULLY** remove the air bag assembly from the vehicle and place it on a clean cloth to protect the dash trim surface portion from damage.

NOTE: There may be a Security Module secured with the lower air bag assembly mounting bolt on some models.

IMPORTANT: DO NOT destroy or damage the kit box as it MUST be used for the original inflator's return shipping.

Product Safety Recall

15818 Front Passenger Air Bag Inflator



5145838

6. Open the front passenger air bag inflator kit box and confirm all the necessary components are included:
- 4 Self-Locking nuts
 - New Type 2 Inflator (pink collars on each end identify it as the replacement part)
 - New Inflator Harness
 - New Stopper Plate
 - Electro-Tap (red shorting crimp connector)
 - 1 ½" X 2 ¼" piece of self-adhesive Sponge Tape
 - Shipping Documentation and Instructions

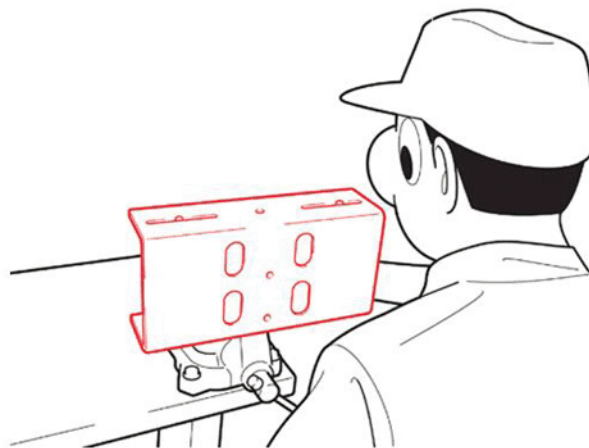
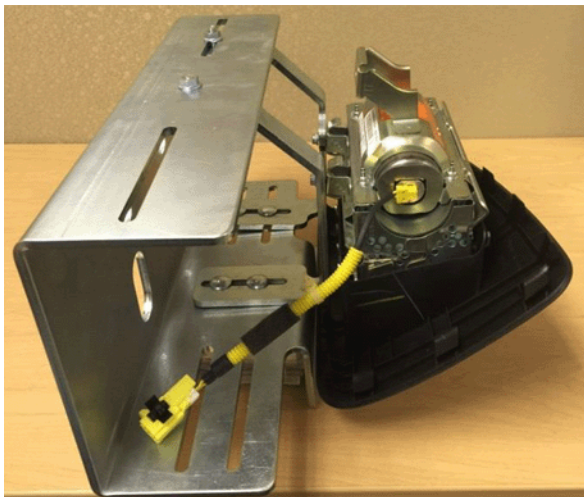

5145840

WARNING: The removed air bag assembly must be mounted to the air bag mounting bracket (Tool # EL-51377) as shown in the photo to better secure it during the inflator and wiring harness component replacement procedures.

Always perform this work in an area away from others to reduce chances of inadvertent injury should any deployment occur. Take your surroundings into account to avoid possible hazards should inadvertent deployment occur or sources of static or other electricity that could potentially induce such a deployment.

CAUTION: Never use any silicone-based products for this purpose.

Product Safety Recall

15818 Front Passenger Air Bag Inflator

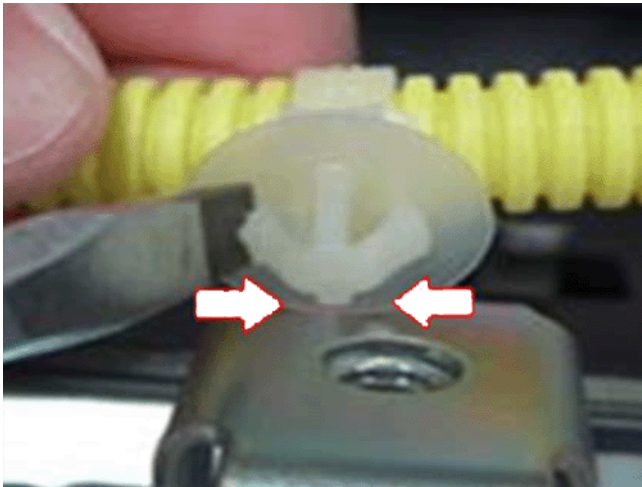

5145841

7. Peel the Sponge Tape and remove the harness clip from the retainer bracket by pushing the tangs inward with a flat-blade screwdriver as shown. Always remove any Sponge Tape adhesive residue from the air bag mounting bracket using mild solvent on a clean shop cloth.

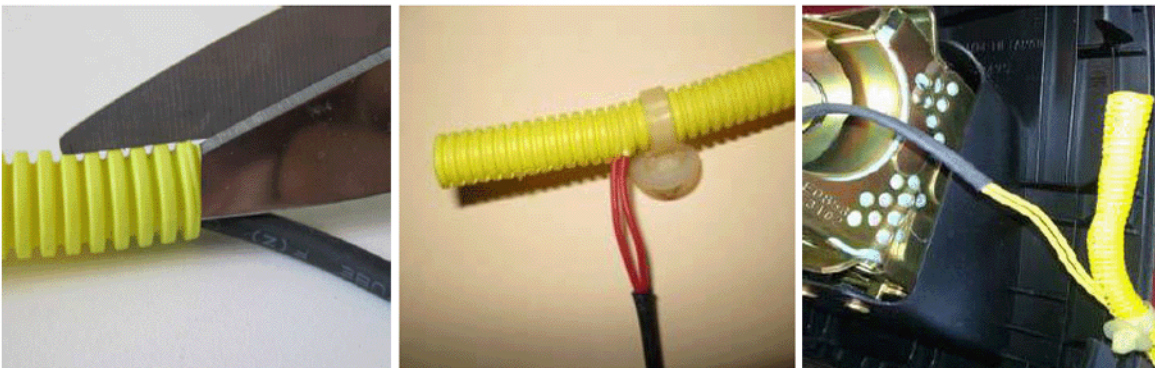

5145843

8. CAREFULLY cut the yellow harness cover enough (approximately 2 inches) to expose the 2 red (or yellow) wires inside and provide enough room to install the Electro-Tap (shorting) connector using a wire cutter or scissor (no knives or razors). TAKE YOUR TIME AND BE CAREFUL TO NOT CUT THE 2 WIRES!

Product Safety Recall

15818 Front Passenger Air Bag Inflator

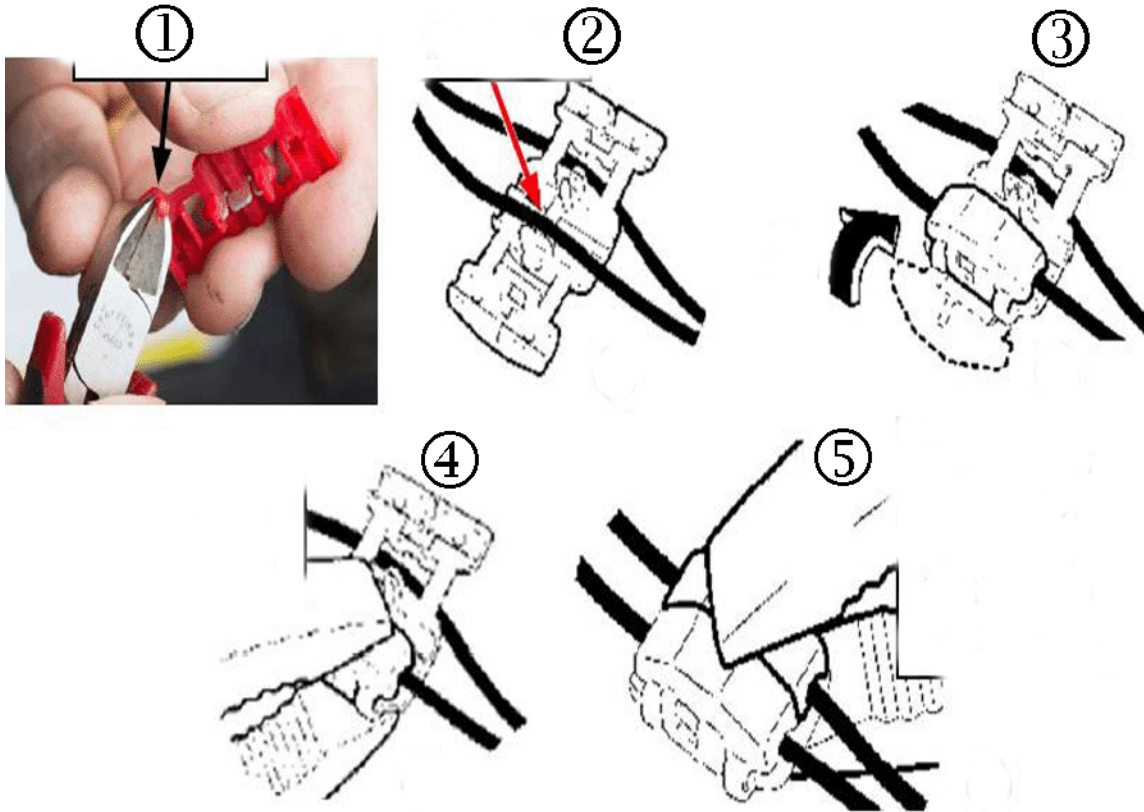

5145844

- (1) This tab must be cut off.
 - (2) Insert 1 wire in the Electro-Tap.
 - (3) Fold.
 - (4) Crimp closed with pliers.
 - (5) Place the other wire in the Electro-Tap, fold then crimp closed with pliers.
9. Short the 2 wires together by installing the Electro-Tap connector. The connector creates a short circuit which acts as a safeguard to prevent against static discharge that may deploy the removed inflator. The tab portion of the Electro-Tap connector **MUST** be cut off prior to use to ensure a good short-circuit is made as shown in the illustration below. **Follow the sequence** below for installing the Electro-Tap connector. Use pliers to squeeze closed the two sections of the connector together, **one section at a time**.

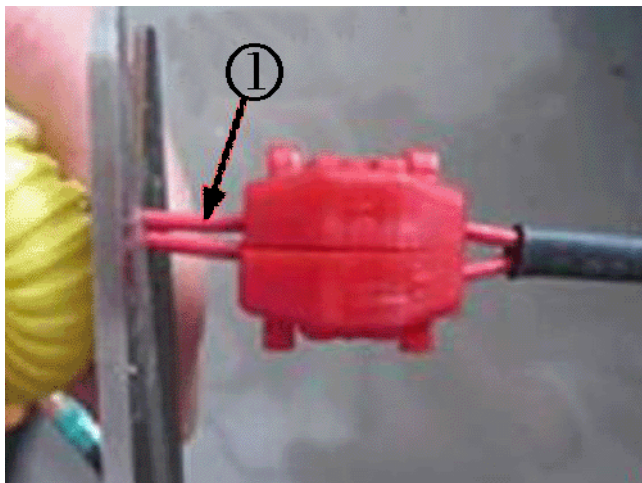

5145846

Product Safety Recall

15818 Front Passenger Air Bag Inflator



10. Once the Electro-Tap connector is fully crimped in place, cut the 2 wires (1) on the body harness connector side of the Electro-Tap connector.

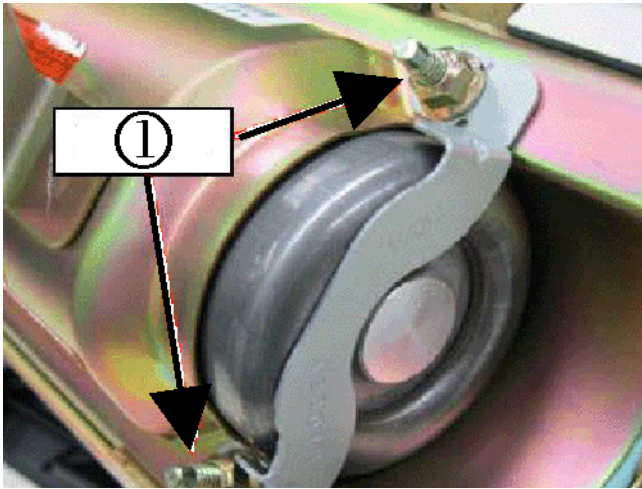

5145848

11. Remove the two 8mm self-locking nuts (1) securing the stopper plate. Loosen but do not remove the other two nuts on the mounting bracket as leaving them in place will help keep the air bag assembly together.



5145849

12. With the stopper plate removed and the other 2 self-locking nuts loosened, unseat the inflator off the mounting bracket end plate then rotate it slightly **CLOCKWISE** to make it easier to remove as shown in the photo to the right. Slide the inflator out of its mounting while feeding the cut off portion of the wiring harness through the “D-Shaped” hole in the end of the mounting bracket. **NEVER ATTEMPT TO REMOVE THE HARNESS FROM THE INFLATOR!**

13. Place the removed original air bag inflator in the “cradle” of the kit box insert.



5145854

Product Safety Recall

15818 Front Passenger Air Bag Inflator



14. VERY IMPORTANT: Record the 11-digit alpha-numeric serial number for both the removed (Type 1) and 14-digit numeric serial number for the new (Type 2) inflator on the job card hard copy. This information will be required for completion of the Part Return Notice. The new 14-digit numeric serial number is also a requirement for claim entry.

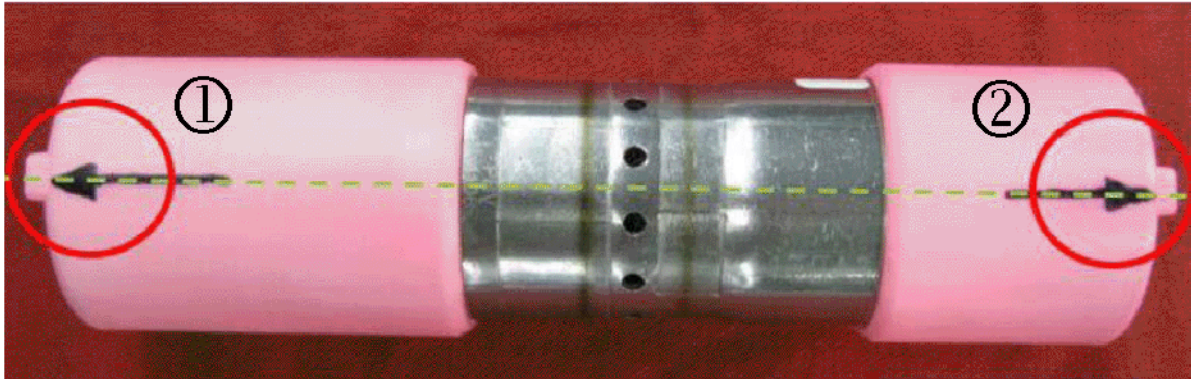

5145856

15. Inspect the new **Type 2** inflator to confirm the locating protrusions on each of the pink-collar portions are aligned as shown below. The “short” collar can be rotated as needed to align it with the protrusion on the “long” collar if necessary.

NOTE: The Type 2 inflator is installed in the opposite direction of the original. This change puts the connector on the other end. The new harness has been extended approximately 2” to compensate.

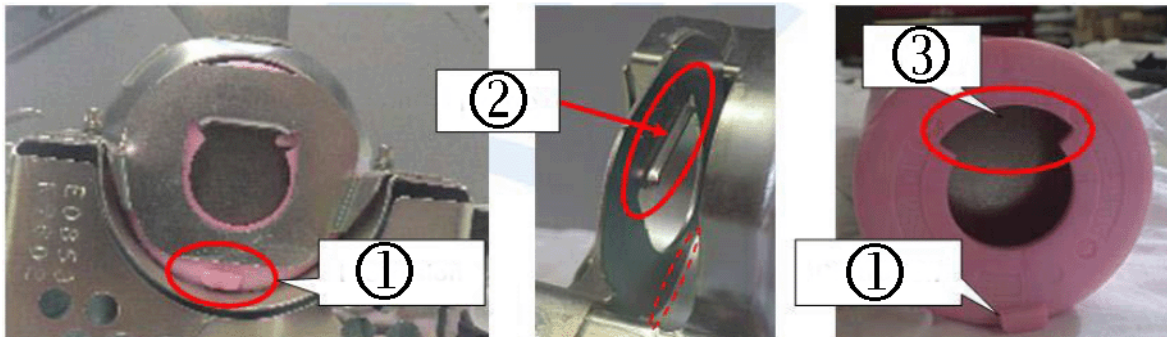

5145858



5145861

Product Safety Recall

15818 Front Passenger Air Bag Inflator

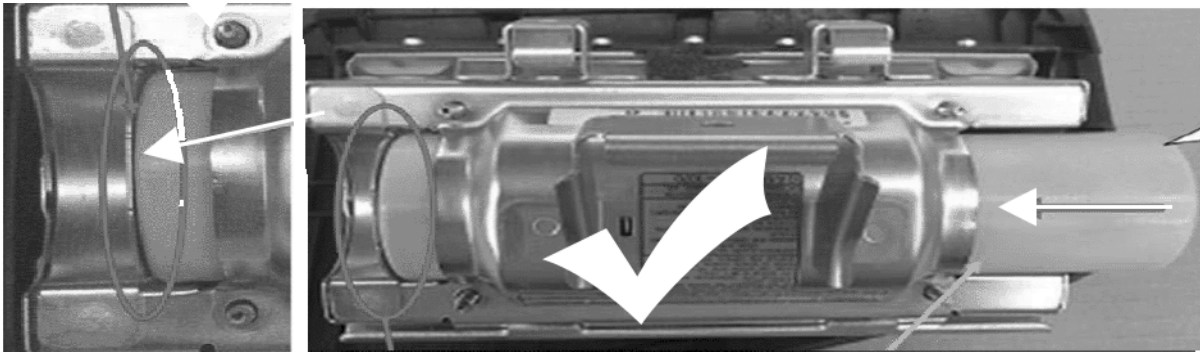

5145863

16. Install the new inflator into the mounting bracket, short collar with the “blank” (no harness connector) end going in first. The protrusion (1) on the short collar will fit in the gap at the bottom of the fixed stopper plate portion. At the same time, the ridge (2) portion of the inflator side of the stopper plate will fit into the “notch” (3) in the end of the collar. When properly installed, the end of the inflator will be seated tight against the mounting bracket with NO gap. DO NOT peel the white harness connection dust cover at this time.

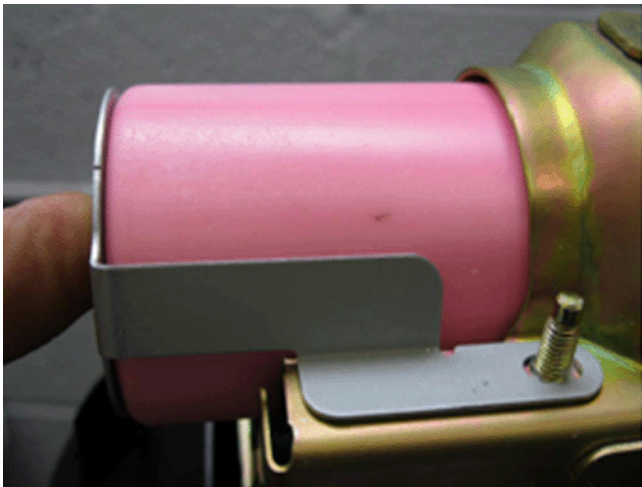

5145864

IMPORTANT: Always hold the stopper plate tight against the inflator as shown above while installing and tightening the **NEW** self-locking nuts. NEVER reuse the original nuts.

17. Install the new stopper plate over the harness connector end of the new inflator.



5145865

18. Remove the 2 nuts still installed on the mounting bracket and replace them with 2 **NEW** self-locking nuts. Once all 4 **NEW** nuts are in place, torque to 31-38-inch pounds in the new sequence shown below. Use a marker to mark the nuts after torquing indicating they have been fully tightened.

Product Safety Recall

15818 Front Passenger Air Bag Inflator

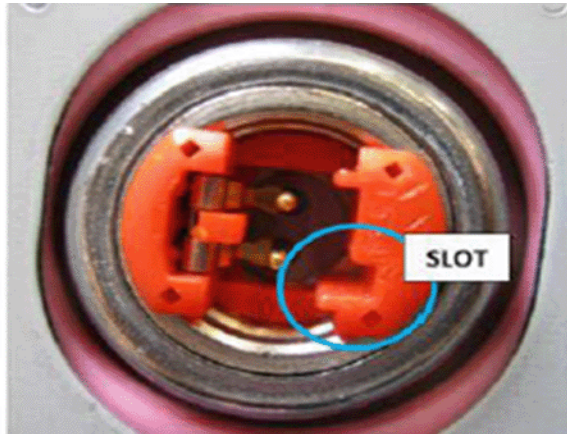

5145867

19. Peel off the white dust cover and **CAREFULLY** align the tang of the new harness connector with the receiving slot in the inflator connector. This assures proper routing of the harness in relation to the air bag assembly mounting brackets.

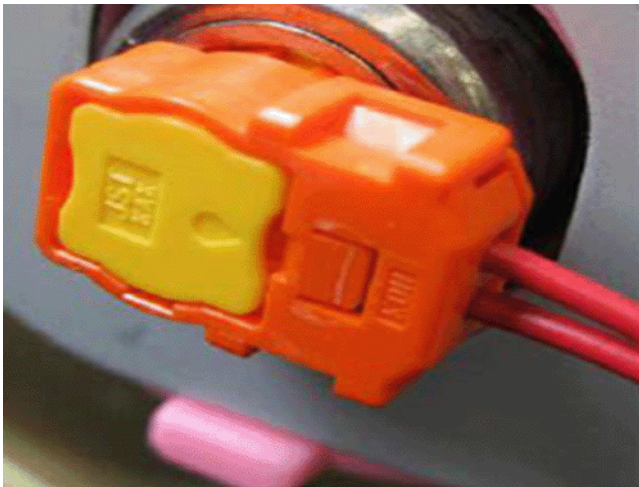

5145869

20. Once alignment is confirmed, push down firmly to engage the connector. When fully seated, press down on the yellow tab locking the connector to the inflator.

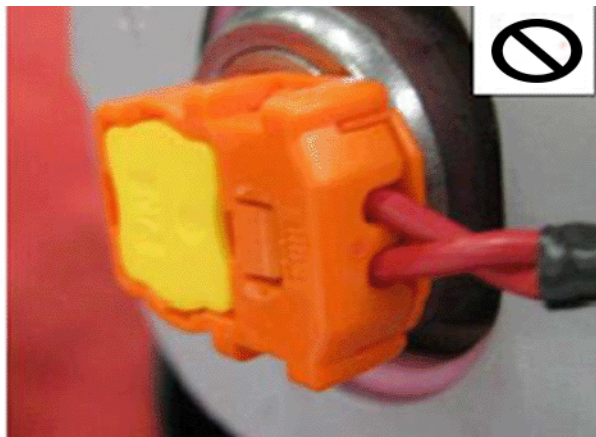
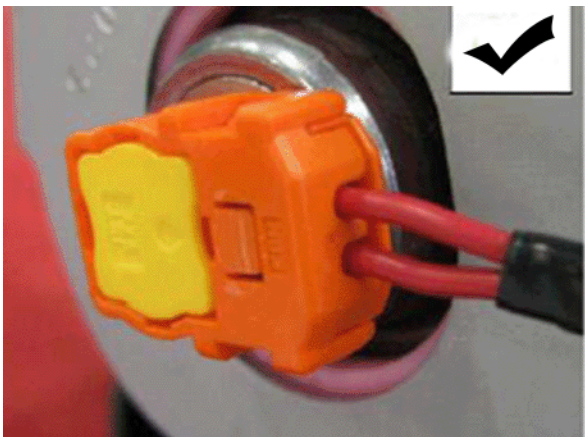

5145870

IMPORTANT: Confirm the harness is not twisted at the inflator connector as shown below.

Product Safety Recall

15818 Front Passenger Air Bag Inflator

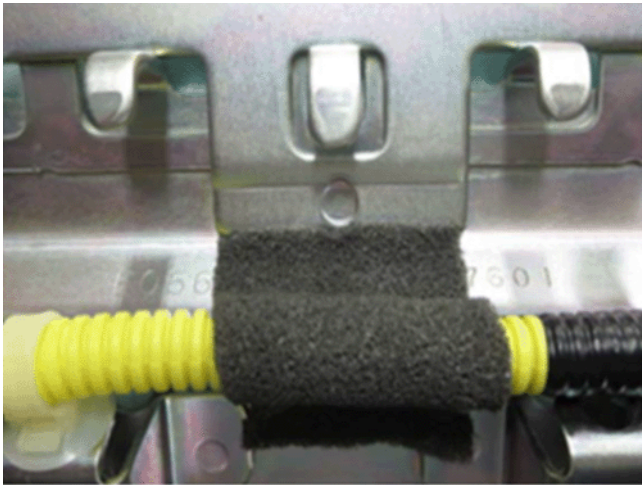

5145871

21. Peel the adhesive backing and install the new Sponge Tape onto the yellow harness tube first then adhere it to the air bag mounting bracket as shown.

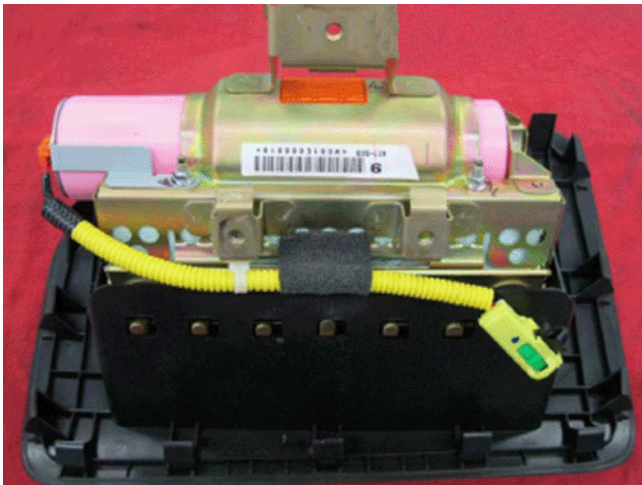

5145874

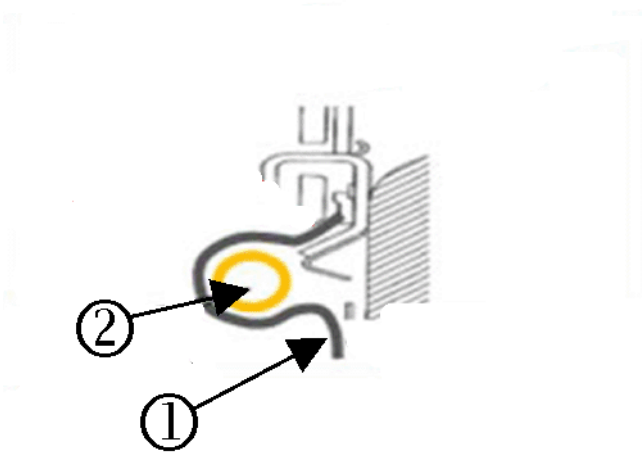

5145875

IMPORTANT: Cross section of the sponge tape installation. The sponge tape (1) must be installed more than half way around the yellow harness tube (2).

22 Install the air bag assembly into the vehicle.

22.1 Carefully place the air bag assembly through the top of the dash. Push down to install.

Product Safety Recall

15818 Front Passenger Air Bag Inflator



22.2 Install the 3 retaining bolts from the bottom and torque to 7 Nm (62 lb in).

NOTE: If a Security Module was originally installed to one of the lower air bag assembly mounting bolts, reattach the Security Module. Torque that specific bolt to 10 Nm (88 lb in) +/-Nm rather than the normal 7 Nm (62 lb in).

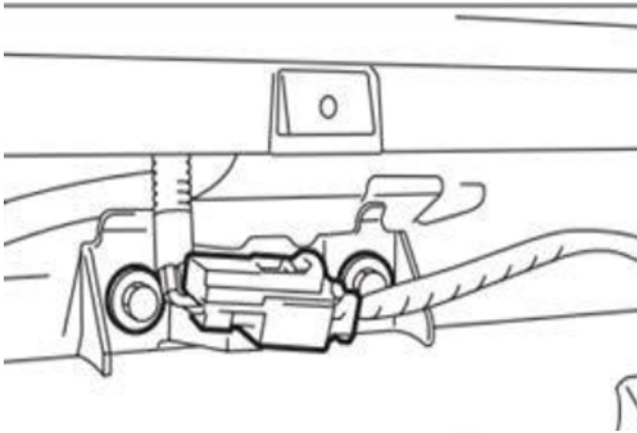

5145837

23. Reconnect the air bag assembly harness connector and attach it to the support beam bracket.

NOTE: Before installing the glove box assembly, reconnect the negative battery cable. Turn the ignition key "ON" and confirm the "AIRBAG" warning light comes on then cycles off properly. Once proper warning light operation is confirmed, reinstall the glove box assembly, while making sure the cord loop for the opening dampener (if equipped) stays connected.

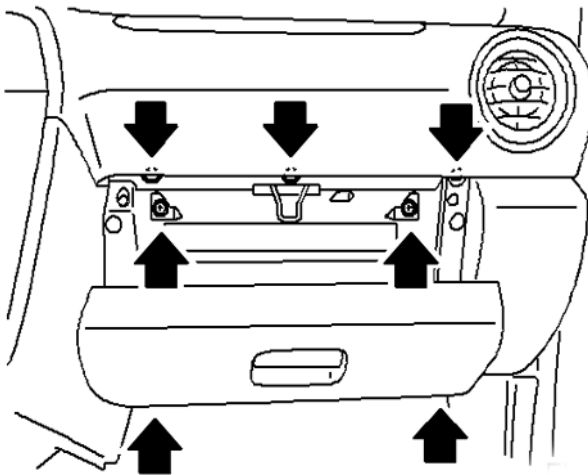

5145835

24. Reinstall the glovebox and ensure it closes properly.

25. Place the removed air bag inflator in the "cradle" of the kit box insert, with a copy of the job card attached to it. The job card number, repair date, repair mileage and full 17-character VIN must be clearly visible on the job card.

26. Check for Diagnostic Trouble Codes (DTCs).

WARNING: Do not deploy any front passenger air bag inflator prior to shipment. Doing so could result in severe injury to the technician or other people in the area.

IMPORTANT: All front passenger air bag inflators replaced in accordance with this recall must be returned to TK Holdings, Incorporated. Under no circumstances should any replaced air bag inflator be returned to GM, ORIO or Subaru of America. Refer to the return shipping instructions provided at the end of this bulletin.

NOTE: When affixing return shipping labels to the box do not obstruct the bar code label. A copy of the job card must also be included in the box with the returned air bag inflator. The job card number, repair date, repair mileage and full 17-character VIN must be clearly visible on the job card.

Product Safety Recall

15818 Front Passenger Air Bag Inflator



DTC Code Table

DTC	Memory Function	Contents of Diagnosis
11	Provided	<ul style="list-style-type: none"> •Air bag main harness circuit is open, shorted or shorted to ground. •Air bag module harness (driver) circuit is open, shorted or shorted to ground. •Roll connector circuit is open, shorted or shorted to ground. •Air bag control module is faulty. •Driver's air bag module is faulty.
12	Provided	<ul style="list-style-type: none"> •Air bag main harness circuit is open, shorted or shorted to ground. •Air bag module harness (passenger) circuit is open, shorted or shorted to ground. •Air bag control module is faulty. •Passenger's air bag module is faulty.
15	Provided	<ul style="list-style-type: none"> •Air bag main harness circuit (driver) is shorted to power supply. •Air bag module harness (driver) is shorted to power supply. •Roll connector is shorted to power supply. •Air bag control module is faulty. •Driver's air bag module is faulty.
16		<ul style="list-style-type: none"> •Air bag main harness circuit (passenger) is shorted to power supply. •Air bag module harness (passenger) is shorted to power supply. •Air bag control module is faulty. •Passenger's air bag module is faulty.
21		<ul style="list-style-type: none"> •Air bag control module is faulty.
22		<ul style="list-style-type: none"> •Front air bag module and seat belt pretensioner (LH/RH) are inflated.
23	Not Provided	<ul style="list-style-type: none"> •(AB3), (AB7) and (AB8) are not connected properly to air bag control module.
24	Not Provided	<ul style="list-style-type: none"> •Air bag control module is faulty. •Air bag main harness circuit is open. •Fuse No. 11 (in joint box) is blown. •Body harness circuit is open.
25		<ul style="list-style-type: none"> •Air bag control module is faulty. •Air bag main harness circuit is open. •Fuse No. 6 (in joint box) is blown. •Body harness circuit is open.
31		<ul style="list-style-type: none"> •Front sub sensor harness (RH) circuit is shorted. •Front sub sensor harness (RH) circuit is open. •Front sub sensor (RH) is faulty. •Air bag control module is faulty.
32		<ul style="list-style-type: none"> •Front sub sensor harness (LH) circuit is shorted. •Front sub sensor harness (LH) circuit is open. •Front sub sensor (LH) is faulty.

Product Safety Recall
15818 Front Passenger Air Bag Inflator



		<ul style="list-style-type: none"> •Air bag control module is faulty.
41		<ul style="list-style-type: none"> •Side air bag harness (RH) is faulty. •Side air bag module (RH) is faulty. •Air bag control module is faulty.
42		<ul style="list-style-type: none"> •Side air bag harness (LH) is faulty. •Side air bag module (LH) is faulty. •Air bag control module is faulty.
45		<ul style="list-style-type: none"> •Side air bag harness (RH) is shorted to power supply. •Air bag control module is faulty.
46		<ul style="list-style-type: none"> •Side air bag harness (LH) is shorted to power supply. •Air bag control module is faulty.
51		<ul style="list-style-type: none"> •Side air bag sensor (RH) is faulty. •Side air bag harness (RH) is faulty. •Air bag control module is faulty.
52		<ul style="list-style-type: none"> •Side air bag sensor (LH) is faulty. •Side air bag harness (LH) is faulty. •Air bag control module is faulty.
53		<ul style="list-style-type: none"> •Side air bag sensor (RH) is faulty.
54		<ul style="list-style-type: none"> •Side air bag sensor (LH) is faulty.
55		<ul style="list-style-type: none"> •Side air bag module is inflated.
61		<ul style="list-style-type: none"> •Seat belt pretensioner (RH) circuit is open, shorted or shorted to ground. •Air bag control module is faulty. •Pretensioner is faulty. •Pretensioner harness is faulty.
62		<ul style="list-style-type: none"> •Seat belt pretensioner (LH) circuit is open, shorted or shorted to ground. •Air bag control module is faulty. •Pretensioner is faulty. •Pretensioner harness is faulty.
65		<ul style="list-style-type: none"> •Seat belt pretensioner (RH) circuit is shorted to power supply. •Pretensioner is faulty. •Pretensioner harness is faulty. •Air bag control module is faulty.
66		<ul style="list-style-type: none"> •Seat belt pretensioner (LH) circuit is shorted to power supply. •Pretensioner is faulty. •Pretensioner harness is faulty. •Air bag control module is faulty.

Product Safety Recall

15818 Front Passenger Air Bag Inflator



Dealer Responsibility – U.S. States, Territories, and Possessions

It is a violation of Federal law for a dealer to deliver a new motor vehicle or any new or used item of motor vehicle equipment (including a tire) covered by this notification under a sale or lease until the defect or noncompliance is remedied.

The U.S. National Traffic and Motor Vehicle Safety Act provides that each vehicle that is subject to a recall of this type must be adequately repaired within a reasonable time after the customer has tendered it for repair. A failure to repair within sixty days after tender of a vehicle is prima facie evidence of failure to repair within a reasonable time. If the condition is not adequately repaired within a reasonable time, the customer may be entitled to an identical or reasonably equivalent vehicle at no charge or to a refund of the purchase price less a reasonable allowance for depreciation. To avoid having to provide these burdensome remedies, every effort must be made to promptly schedule an appointment with each customer and to repair their vehicle as soon as possible. In the recall notification letters, customers are told how to contact the U.S. National Highway Traffic Safety Administration if the recall is not completed within a reasonable time.

All new, used, GM Certified Used, courtesy transportation vehicles, dealer shuttle vehicles, etc. in dealers' possession and subject to this recall must be held and inspected/repaired per the service procedure of this bulletin before customers take possession of these vehicles. Involved vehicles must be held and not delivered to customers, dealer-traded, released to auction, used for demonstration, or any other purpose.

All GM Certified Used vehicles currently in the dealers' inventory within the Certified Pre-Owned Inventory System (CPOIS) will be de-certified and must be held and remedied per the service procedure in this bulletin. Upon submitting an accepted/paid warranty transaction in the Global Warranty Management (GWM) system, the vehicle can be re-certified for sale within the CPOIS system, or once again be used in the CTP program.

Dealers are to service all vehicles subject to this recall at no charge to customers, regardless of mileage, age of vehicle, or ownership, from this time forward.

Customers who have recently purchased vehicles sold from your vehicle inventory, and for which there is no customer information indicated on the dealer listing, are to be contacted by the dealer. Arrangements are to be made to make the required correction according to the instructions contained in this bulletin. Recall follow-up cards should not be used for this purpose, since the customer may not as yet have received the notification letter.

In summary, whenever a vehicle subject to this recall enters your vehicle inventory, or is in your dealership for service in the future, you must take the steps necessary to be sure the recall correction has been made before selling or releasing the vehicle.

Dealer Reports

For dealers with involved vehicles, a listing with involved vehicles has been prepared and will be provided to U.S. dealers through the GM GlobalConnect Recall Reports. The listing may contain customer names and addresses obtained from motor vehicle registration records. The use of such data for any purpose other than follow-up necessary to complete this recall is a violation of law in several U.S. states/territories/possessions. Accordingly, you are urged to limit the use of this report to the follow-up necessary to complete this recall.

Customer Notification

General Motors will notify customers by letter of this recall on their vehicle.

GM bulletins are intended for use by professional technicians, NOT a "do-it-yourselfer". They are written to inform these technicians of conditions that may occur on some vehicles, or to provide information that could assist in the proper service of a vehicle. Properly trained technicians have the tools, equipment, safety instructions, and know-how to do a job properly and safely. If a condition is described, DO NOT assume that the bulletin applies to your vehicle, or that your vehicle will have that condition. See your dealer for information on whether your vehicle may benefit from the information.



**We Support
Voluntary Technician
Certification**

Product Safety Recall

15818 Front Passenger Air Bag Inflator



RETURN PROCEDURE - AIRBAG INFLATORS Continental U.S. - Saab OSCs Only! (48 States).

NOTE: Saab OSCs outside of the Continental United States (Hawaii, Alaska, Puerto Rico, Virgin Islands INCLUDING Mexico and Canada CANNOT follow below shipping instructions. Instead, Saab OSC in these locations MUST contact the following Takata/XPO USA representative directly for shipping instructions: XPO Representative Armando Gonzales– Tel #: 210-250-5039 or Email: SCTakataRestrains_International@XPO.com or MLGTakataRestrains_International@menloworldwide.com

1. Packing Instructions



a) Confirm box is in acceptable condition. If a new box is needed, follow the New Box instructions located **In Box #9 of this page.**

b) Place the un-deployed air bag inflator in the “cradle” of the box insert.

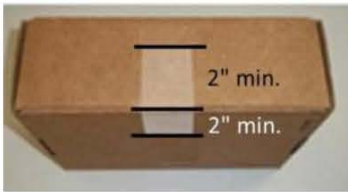

2. Closure Instructions

a) Close the top box flap, per box closure instructions located on front panel of box.

3. Schedule Pickup

a) **Every 90 days or upon accumulating 200 kits (1 Pallet) minimum**

- Call XPO at 1-877-650-3476
- Have the following Information Available
 - Saab OSC #
 - Quantity of Pallets, Boxes
 - Quantity of Passenger Inflator Kits in each Pallet or Box
 - Email address where shipping docs should be sent for LTL
- If LESS than 10 inflators are being returned - REFER TO BOX - #4**
 - A FedEx Package Return Program (PRP) will be authorized by XPO.
 - Required documents will be sent at that time (shipping address will be request at this time).
- If More than 10 inflators are being returned - REFER TO BOX - #5**
 - A Less Than Truckload (LTL) shipment will be arranged.

4. FedEx – Package Return Program (PRP) - Label each Box

a) If you have less than 10 Inflator Kits OR existing kits ready to ship, follow PRP process

- Peel off the backing of the FedEx Ground PRP Shipping label and **affix to top of each box to left of the Class 9 label (see below)**
 - Use the scribe line on the box as a guide.
 - The FedEx Ground PRP Shipping label must not touch any portion right of the scribe line.
- OP900PRP label is a multiple part label, please see below for further instructions**
- A single combined shipment of your individually labeled boxes will **be scheduled by XPO (Example: one shipment of 9 boxes)**
- Do Not** contact FedEx **unless you are instructed to by XPO.**

XPO will send post mail to the OCS the following:



Kit Box will look like this

5. LTL Shipping Instructions - Label each box

a) **If you do not have labels, please refer to BOX #9.**



6. LTL Shipping Documents (Less than Truckload)

a) **Box Label**

- Supplied with each Kit
- Affix address label to each box

b) **Over-pack Label**

- To be supplied by XPO.
- To be affixed to the outside of each pallet

c) **Bill of Lading**

- To be supplied by XPO.
- Print 2 copies: 1 for Saab OSC Records, 1 for LTL Driver

d) **ERG Document**

- To be supplied by XPO.
- To be provided by the Saab OSC to the LTL Driver for each shipment

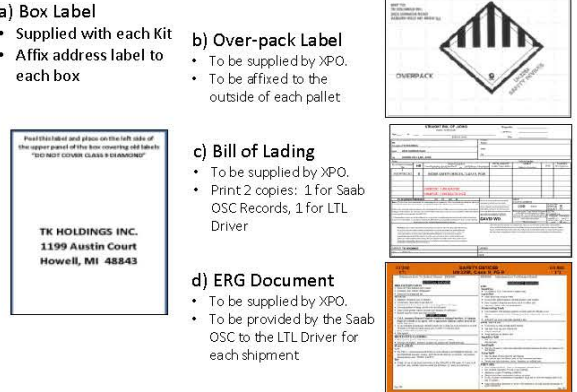

7. If LTL - Prepare the pallet or box(es) for shipment

a) Accumulate and palletize or box kits

b) Arrange Kits on Pallet as pictured here

- 20 boxes per row/layer (5x4)
- 10 rows/layers per pallet (200 boxes)

c) Shrink-wrap Kits to Pallet

d) Affix Over-pack Label on (1) side of Pallet (Not on Top)



8. Complete the Shipment

a) If LTL - Give 1 Copy of BOL and 1 Copy of ERG to Driver

b) Retain 1 Copy of BOL and archive for 2 Years

9. Requesting a New Box / Shipping Labels

If a new box or replacement shipping labels are needed, please contact the representative listed below to request replacement materials.

XPO Customer service Rep Tel #: 210-250-5079
E-Mail: SCFieldAction.14305@xpo.com

To help expedite your request, be prepared to provide the following:

- Serial number on the original box
- What Type of shipping material needed
 - Replacement Box
 - Two Part Return Label
 - Bill of Lading
 - ERG Form
- Saab OSC Shipping Information
 - Contact name
 - Saab OSC Address
 - Phone Number



Product Safety Recall

15818 Front Passenger Air Bag Inflator



Canada Only - "Used Airbag Return Process - for Recalls Only"

The following instructions is the return process for used airbag as identified in Recall Bulletins.
IMPORTANT: Do not deploy any airbag. The person packing the used airbag module must read & follow the instructions below.

Shipping/Handling Instructions: On top of the Box CLEARLY WRITE (Large Print):

"USED AIRBAG - RECALL # (IDENTIFY RECALL NUMBER)"

Insert a completed copy of the R.O. The following information about the vehicle being serviced with the replacement inflator must be documented and returned with the suspect inflator removed from the vehicle.

VIN (17 Characters):

Vehicle Make, Model and Model Year:

Odometer reading:

Dealership Postal Code:

Canadian Dealers: Airbag returns are to be processed through your normal return process. No return tag/credit will be issued for used airbags. Refer to Recall Bulletins for applicable returns required.

- Complete a PC0302C (302C) form and ensure that the TDG section is completed correctly.
- At time of returns pickup, provide driver with the 302C form with the used airbag(s) properly manifested, for shipment back to your PDC.
(Driver will not pick up any product without this document filled out and signed.)

PDC contact and fax numbers for YOUR Servicing PDCs:

- Woodstock Service Dealers (519) 536-7410 Fax: (519) 536-7409
- Edmonton Service Dealers (780) 451-7019 Fax: 1-866-350-6233
- Montreal Service Dealers (514) 630-6162 Fax: (514) 630-7362
- Vancouver Service Dealers (604) 857-4347 Fax: (604) 857-4402

« Processus de retour des sacs gonflables usagés – Rappels seulement »

Uniquement au Canada

Les renseignements suivants concernent le processus de retour des sacs gonflables usagés, comme indiqué dans les bulletins de rappel. **IMPORTANT : Ne pas déployer le sac gonflable. La personne qui emballe le module de sac gonflable usagé doit lire et suivre les instructions ci-dessous.**

Directives relatives à l'expédition et la manutention : Sur le dessus de la boîte, INSCRIVEZ LISIblement (en gros caractères) :

« SAC GONFLABLE USAGÉ – RAPPEL N° (INDIQUEZ LE NUMÉRO DE RAPPEL) »

Insérer une copie dûment remplie du bon de réparation. Les renseignements suivants sur le véhicule dans lequel sera installé le dispositif de gonflage neuf doivent être fournis et retournés avec le dispositif de gonflage suspect retiré du véhicule.

NIV (17 caractères) :

Marque, modèle et année modèle du véhicule :

Kilométrage:

Code postal du concessionnaire :

Concessionnaires canadiens : Les retours de sac gonflable doivent être effectués selon votre procédure de retour normale. Aucune étiquette de retour/de crédit ne sera émise pour les sacs gonflables usagés. Reportez-vous aux bulletins de rappel pour les retours applicables requis.

Remplissez le formulaire PC0302C (302C) et assurez-vous que la section TMD est remplie correctement.

- Au moment du ramassage, donnez le formulaire 302C au conducteur avec les sacs gonflables usagés correctement étiquetés pour qu'ils soient retournés à votre CDP.
(Le conducteur ne ramassera pas de produit sans ce document rempli et signé.)

Numéros de téléphone et de télécopieur des CDP :

- Concessionnaires desservis par le CDP de Woodstock : 519 536-7410 Télécopieur : 519 536-7409
- Concessionnaires desservis par le CDP d'Edmonton : 780 451-7019 Télécopieur : 1 866 350-6233
- Concessionnaires desservis par le CDP de Montréal : 514 630-6162 Télécopieur : 514 630-7362
- Concessionnaires desservis par le CDP de Vancouver : 604 857-4347 Télécopieur : 604 857-4402